



Product Description

The Sirenza Microdevices' STM-1116 is a high linearity active mixer for use in a wide variety of communication systems covering the 800-1000 MHz frequency bands. This device operates from a single 5V supply and provides 14 dB of conversion gain while requiring only 0dBm input to the integrated LO driver. The STM-1116 also includes an integrated on chip IF amplifier and is fabricated using Silicon Germanium (SiGe) device technology.

The RF and LO ports can be driven differential or single ended. Each broadband port has been designed to minimize performance degradation while operating into highly reactive components such as SAW filters. The device is packaged in an industry standard 16 pin TSSOP with exposed paddle for superb RF and thermal ground.

Functional Block Diagram

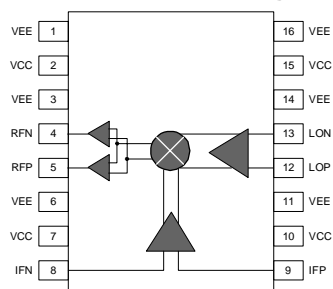

Product Specifications

Parameters	Test Conditions: $T_A = 25^\circ\text{C}$, $V_{CC} = 5.0\text{V}$, $P_{LO} = 0\text{dBm}$, $P_{IF} = -20\text{dBm}$, $f_F = 200\text{MHz}$	Unit	Min.	Typ.	Max.	Min.	Typ.	Max.
RF Frequency Range		MHz	800		900	900		1000
LO Frequency Range		MHz	600		700	700		800
IF Frequency Range		MHz	30	200	400	30	200	400
Conversion Gain		dB	9	12	16	11	14	16
SSB Noise Figure		dB		9.0	11		9.0	11
Output IP3	IF1 = IF2 = -20 dBm/tone, 1 MHz spacing	dBm	17	21		19	22	
Output P1dB		dBm	5	7		6	8.5	
Leakage (LO-RF)		dBm		-35	-25		-30	-20
Leakage (LO-IF)		dBm		-40	-30		-35	-25
RF, LO, IF Return Loss	Matched to 50Ω, see Note 1, page 3	dB		14			14	
Supply Voltage (Vcc)		V	+4.75	+5.0	+5.25	+4.75	+5.0	+5.25
Supply Current		mA		200			200	
LO Drive	Matched to 50Ω	dBm	-3	0	+3	-3	0	+3
Thermal Resistance	junction-case	$^\circ\text{C/W}$		25			25	

The information provided herein is believed to be reliable at press time. Sirenza Microdevices assumes no responsibility for inaccuracies or omissions. Sirenza Microdevices assumes no responsibility for the use of this information, and all such information shall be entirely at the user's own risk. Prices and specifications are subject to change without notice. No patent rights or licenses to any of the circuits described herein are implied or granted to any third party. Sirenza Microdevices does not authorize or warrant any Sirenza Microdevices product for use in life-support devices and/or systems.

Copyright 2002 Sirenza Microdevices, Inc. All worldwide rights reserved.
522 Almanor Ave., Sunnyvale, CA 94085

Phone: (800) SMI-MMIC

1

Preliminary

STM-1116

800 - 1000 MHz High Linearity Active Transmit Mixer



16 pin TSSOP with Exposed Ground Pad

Package Footprint: 0.197 x 0.252 inches (5.0 x 6.4 mm)

Package Height: 0.039 inches (1.0 mm)

Product Features

- Active mixer with 14 dB conversion gain
- Integrated 0dBm LO drive and IF amplifier
- Differential or single-ended input
- Single supply operation (+5V)
- Broadband resistive 50Ω impedance on all three ports
- Low LO-RF leakage

Applications

- AMPS/GSM/CDMA800 transmitters

<http://www.sirenza.com>

EDS102185 Rev B



STM-1116 SiGe Active Transmit Mixer

800-1000MHz Typical Device Performance

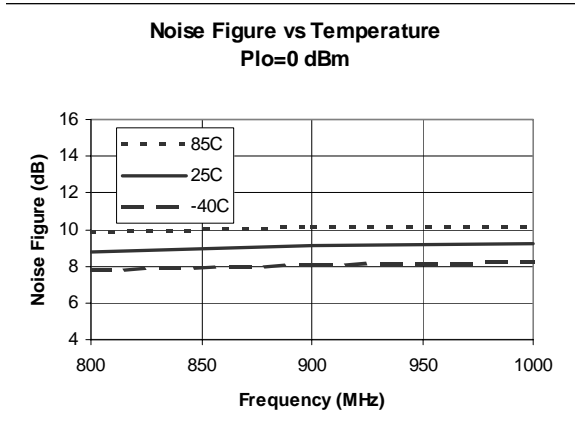
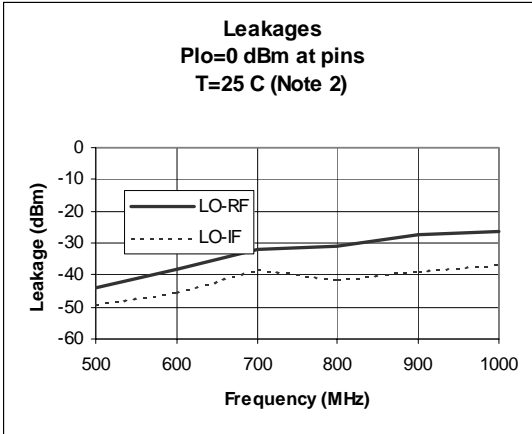
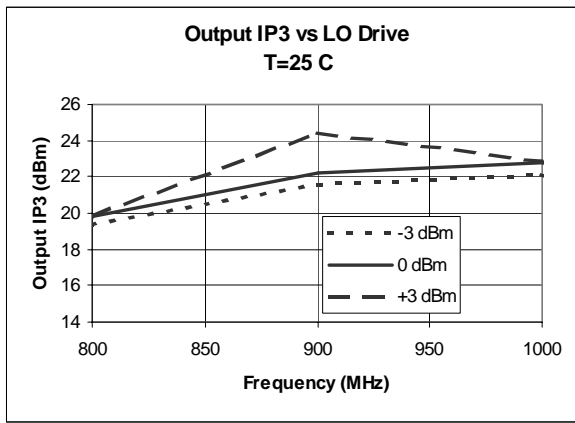
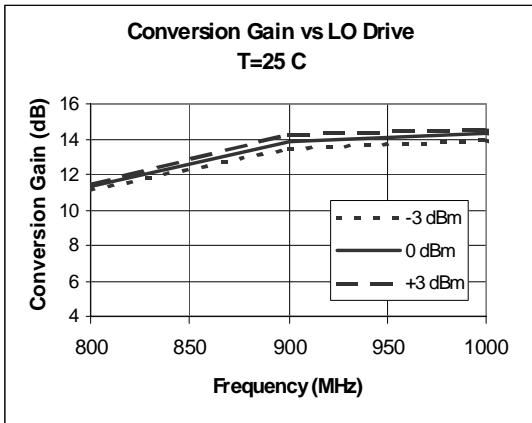
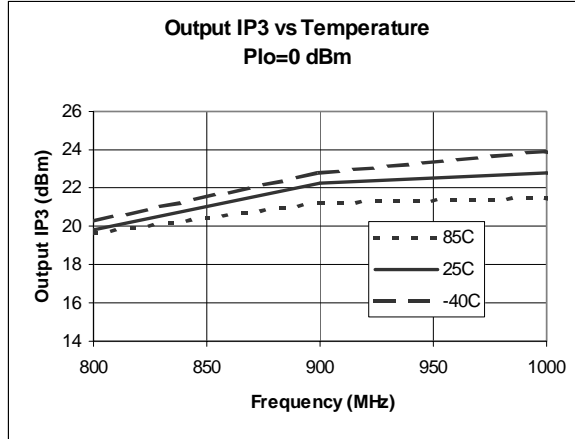
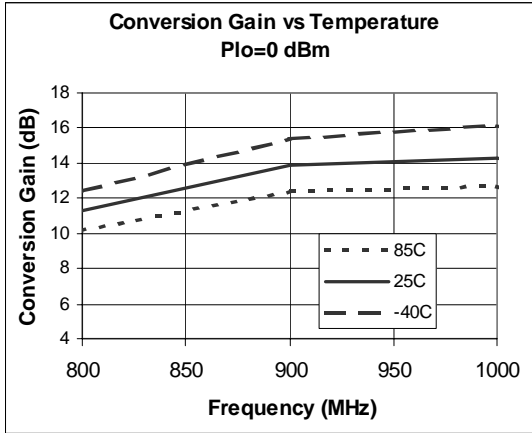



STM-1116 SiGe Active Transmit Mixer

800-1000MHz Typical Device Performance (continued)

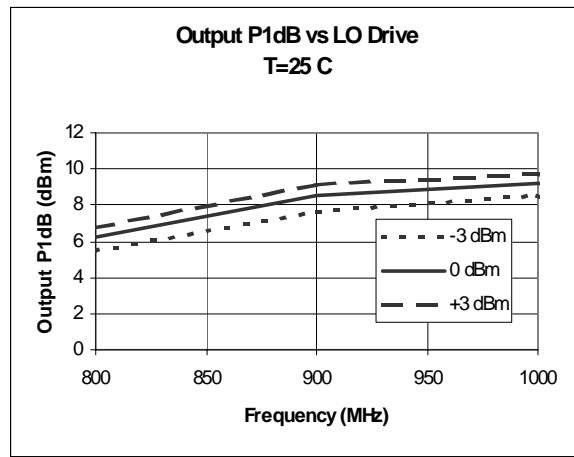
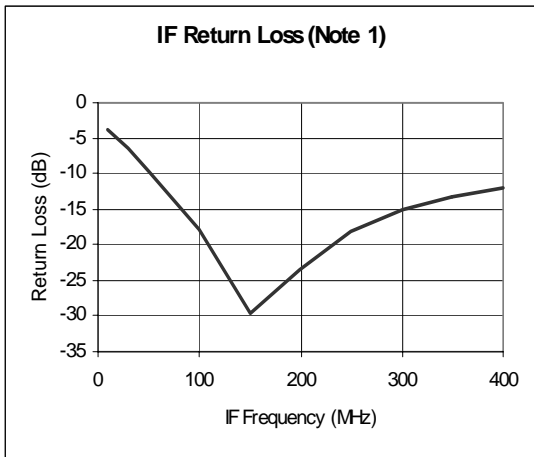
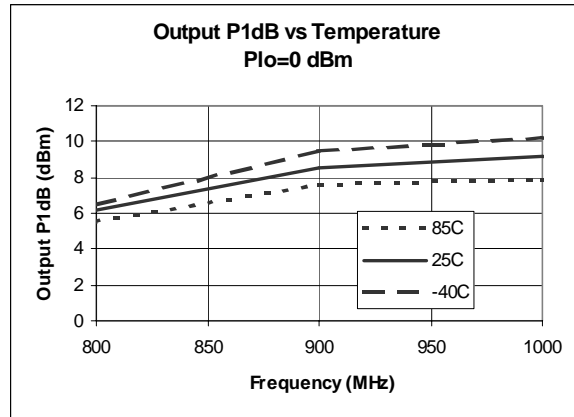
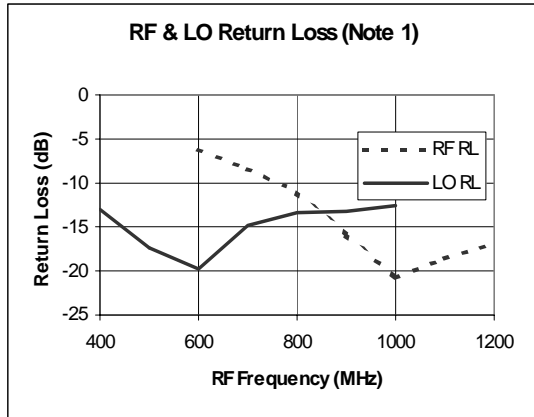

Note 1: The return losses shown were measured with the STM-1116 mounted on our FR4 evaluation boards. The RF port was matched for the GSM band, and the IF port matched for 200 MHz. Similar return losses are achievable at other frequencies using standard matching practices.

Note 2: LO-IF leakage measurement has not been adjusted for the loss through the IF (TC1-1) balun.



STM-1116 SiGe Active Transmit Mixer

Package Dimensions ("16" Package)

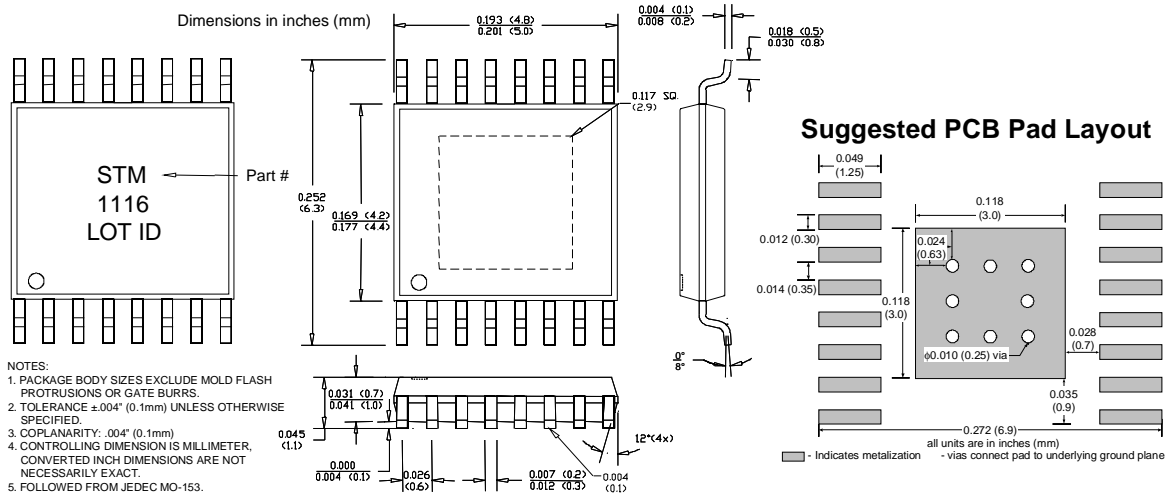

Pin Out Description

Pin #	Function	Description	Additional Comments
1	VEE	Ground	
2	VCC	Positive supply (+5V)	
3	VEE	Ground	
4	RFN	RF output, negative terminal	Nominal DC voltage is 2.3V. (Internally biased) Output should be AC-coupled.
5	RFP	RF output, positive terminal	Nominal DC voltage is 2.3V. (Internally biased) Output should be AC-coupled.
6	VEE	Ground	
7	VCC	Positive supply (+5V)	
8	IFN	IF input, negative terminal	Nominal DC voltage is 2.3V. (Internally biased) Input should be AC-coupled.
9	IFP	IF input, positive terminal	Nominal DC voltage is 2.3V. (Internally biased) Input should be AC-coupled.
10	VCC	Positive supply (+5V)	
11	VEE	Ground	
12	LOP	LO input, positive terminal	Nominal DC voltage is 2.3V. (Internally biased) Input should be AC-coupled.
13	LON	LO input, negative terminal	Nominal DC voltage is 2.3V. (Internally biased) Input should be AC-coupled.
14	VEE	Ground	
15	VCC	Positive supply (+5V)	
16	VEE	Ground	

Absolute Maximum Ratings

Parameters	Value	Unit
Supply Voltage (Vcc)	+6.0	V _{DC}
LO Input (LOP+LON)	+10	dBm
IF Input (IFP, IFN)	+15	dBm
Operating Temperature	-40 to +85	°C
Storage Temperature	-65 to +150	°C

Operation of this device beyond any one of these limits may cause permanent damage. For reliable continuous operation the device voltage and current must not exceed the maximum operating values specified in the table on page one.

Part Number Ordering Information

Part Number	Reel Size	Devices/Reel	
		Min.	Max.
STM-1116	7"	500	1000

Moisture sensitivity level 1 - no special handling required



Caution: ESD Sensitive

Appropriate precaution in handling, packaging and testing devices must be observed.

STM-1116 SiGe Active Transmit Mixer

800-1000MHz Application Schematic

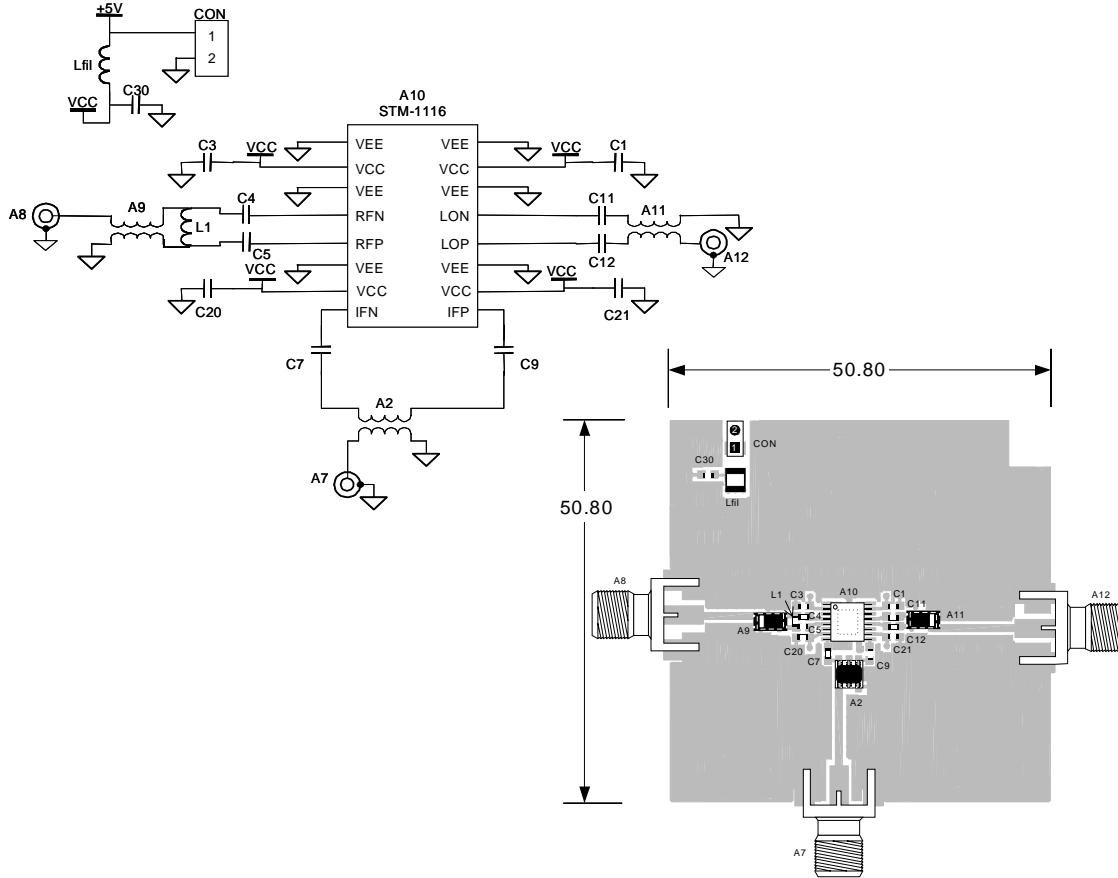

Bill of Materials (for 800-1000MHz Evaluation Board P/N EEB102189)

Component Designator	Value	Qty	Vendor	Part Number	Description
A10		1	SMDI	STM-1116	SiGe Transmit Mixer
A7, A8, A12		3	Johnson Components	142-0701-851	SMA connector, end launch with tab, for 62 mil pitch thick board
CON		1	Digikey	S1212-36-ND	2-pin header
A9, A11	1:1	2	Panasonic	EHF-FD1618	RF transformer
A2	1:1	1	Mini-Circuits	TC1-1	IF transformer
Lfil	1uH	1	Digikey	PCD1008CT-ND	Inductor, 1210 footprint, min. 200mA rating
C1, C3, C20, C21, C30	27pF	5	Venkel	C0603COG500-270JNE	Capacitor, 0603 footprint
C7, C9	100pF	2	Venkel	C0603COG500-101JNE	Capacitor, 0603 footprint
C4, C5	5.6pF	2	Venkel	C0603COG500-5R6CNE	Capacitor, 0603 footprint
L1	39nH	1	TOKO	LL1608-FS39NJ	Inductor, 0603 footprint
C11, C12	22pF	2	Venkel	C0603COG500-220JNE	Capacitor, 0603 footprint

STM-1116 SiGe Active Transmit Mixer

SiGe Transmit Mixer: General Test Set-Up

