



N-Channel Enhancement Mode Field Effect Transistor

PRODUCT SUMMARY

V _{DSS}	I _D	R _{DS(ON)} (mΩ) Max
100V	6A	31 @ V _{GS} =10V

FEATURES

- Super high dense cell design for low R_{DS(ON)}.
- Rugged and reliable.
- Surface Mount Package.



ABSOLUTE MAXIMUM RATINGS (T_A=25°C unless otherwise noted)

Symbol	Parameter	Limit	Units
V _{DS}	Drain-Source Voltage	100	V
V _{GS}	Gate-Source Voltage	±20	V
I _D	Drain Current-Continuous ^{a e}	T _A =25°C	6
		T _A =70°C	4.8
I _{DM}	-Pulsed ^b	30	A
E _{AS}	Single Pulse Avalanche Energy ^d	169	mJ
P _D	Maximum Power Dissipation ^a	T _A =25°C	2.5
		T _A =70°C	1.6
T _J , T _{STG}	Operating Junction and Storage Temperature Range	-55 to 150	°C

THERMAL CHARACTERISTICS

R _{θJA}	Thermal Resistance, Junction-to-Ambient ^a	50	°C/W
------------------	--	----	------

STM105N

Ver 1.0

ELECTRICAL CHARACTERISTICS (T_A=25°C unless otherwise noted)

Symbol	Parameter	Conditions	Min	Typ	Max	Units
OFF CHARACTERISTICS						
BV _{DSS}	Drain-Source Breakdown Voltage	V _{GS} =0V , I _D =10mA	100			V
I _{DSS}	Zero Gate Voltage Drain Current	V _{DS} =80V , V _{GS} =0V			1	uA
I _{GSS}	Gate-Body Leakage Current	V _{GS} = ±20V , V _{DS} =0V			±100	nA
ON CHARACTERISTICS						
V _{GS(th)}	Gate Threshold Voltage	V _{DS} =V _{GS} , I _D =250uA	2	2.6	4	V
R _{DS(ON)}	Drain-Source On-State Resistance	V _{GS} =10V , I _D =3A		25	31	m ohm
g _{FS}	Forward Transconductance	V _{DS} =10V , I _D =3A		12		S
DYNAMIC CHARACTERISTICS ^c						
C _{ISS}	Input Capacitance	V _{DS} =25V, V _{GS} =0V f=1.0MHz		3810		pF
C _{OSS}	Output Capacitance			215		pF
C _{RSS}	Reverse Transfer Capacitance			158		pF
SWITCHING CHARACTERISTICS ^c						
t _{D(ON)}	Turn-On Delay Time	V _{DD} =50V I _D =1A		55		ns
t _r	Rise Time			69		ns
t _{D(OFF)}	Turn-Off Delay Time	V _{GS} =10V R _{GEN} = 6 ohm		76		ns
t _f	Fall Time			47		ns
Q _g	Total Gate Charge	V _{DS} =50V, I _D =3A, V _{GS} =10V		45		nC
Q _{gs}	Gate-Source Charge	V _{DS} =50V, I _D =3A, V _{GS} =10V		7		nC
Q _{gd}	Gate-Drain Charge			14.3		nC
DRAIN-SOURCE DIODE CHARACTERISTICS AND MAXIMUM RATINGS						
V _{SD}	Diode Forward Voltage	V _{GS} =0V, I _S =5A		0.76	1.3	V
Notes						
<p>a.Surface Mounted on FR4 Board,t ≤ 10sec.</p> <p>b.Pulse Test:Pulse Width ≤ 300us, Duty Cycle ≤ 2%.</p> <p>c.Guaranteed by design, not subject to production testing.</p> <p>d.Starting T_J=25°C,L=0.5mH,V_{DD} = 50V.(See Figure13)</p> <p>e.Drain current limited by maximum junction temperature.</p>						

Jul,30,2013

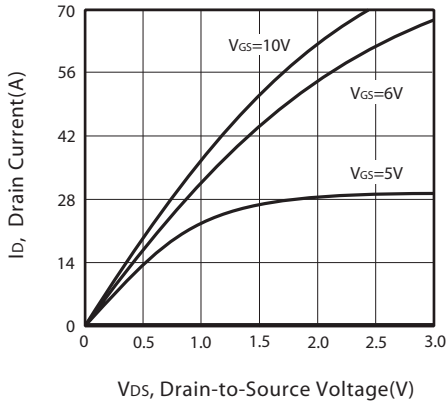

Figure 1. Output Characteristics

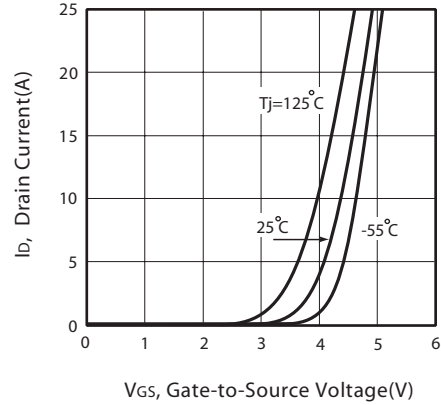

Figure 2. Transfer Characteristics

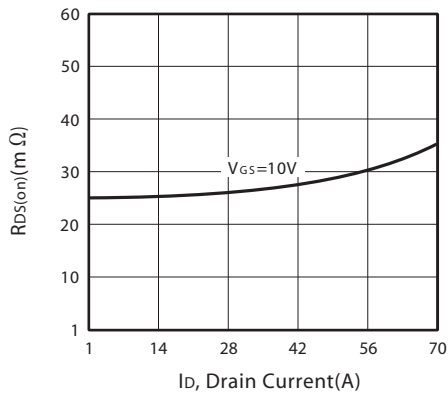

Figure 3. On-Resistance vs. Drain Current and Gate Voltage

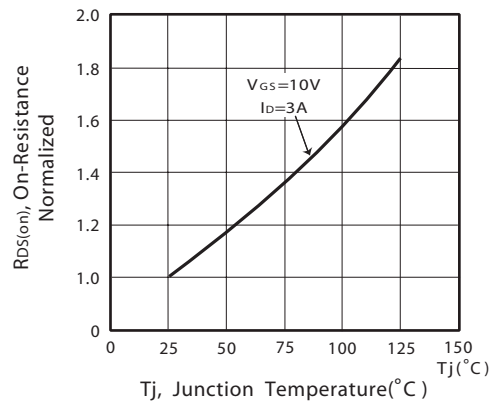

Figure 4. On-Resistance Variation with Drain Current and Temperature

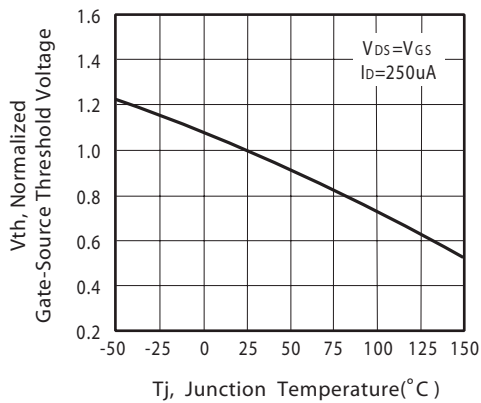

Figure 5. Gate Threshold Variation with Temperature

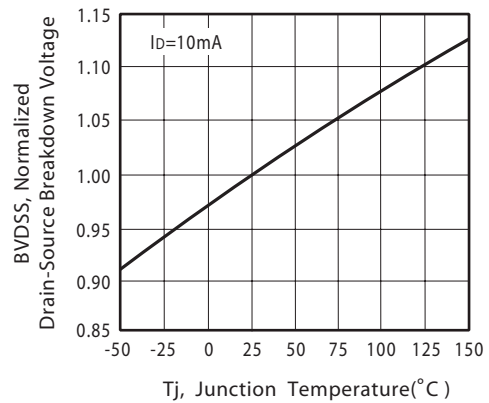

Figure 6. Breakdown Voltage Variation with Temperature

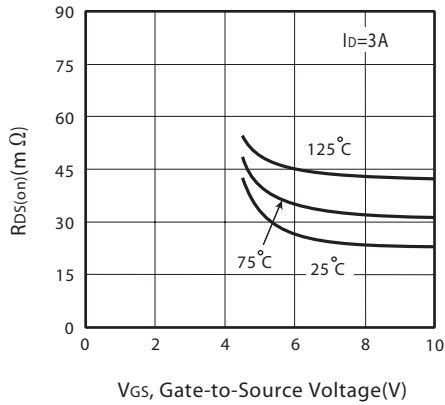

Figure 7. On-Resistance vs. Gate-Source Voltage

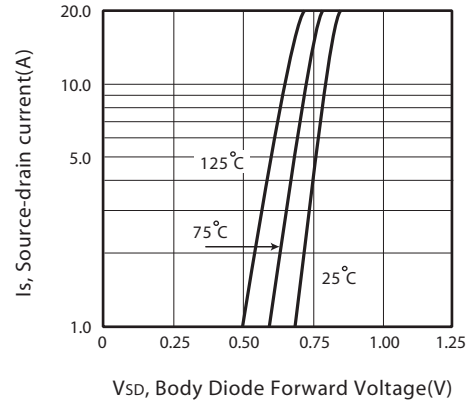

Figure 8. Body Diode Forward Voltage Variation with Source Current

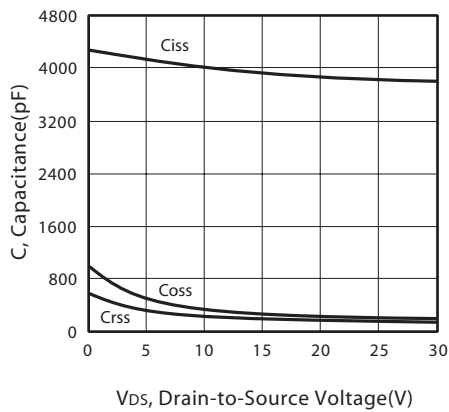

Figure 9. Capacitance

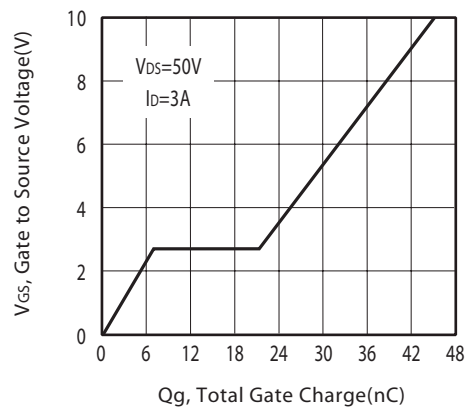

Figure 10. Gate Charge

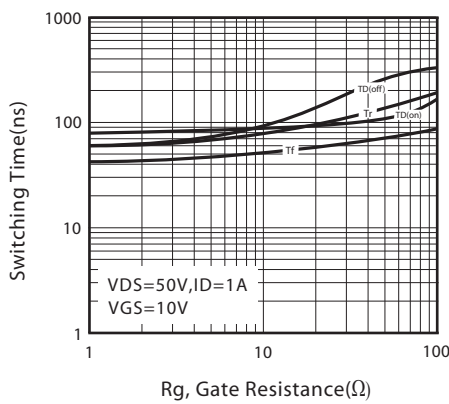

Figure 11. switching characteristics

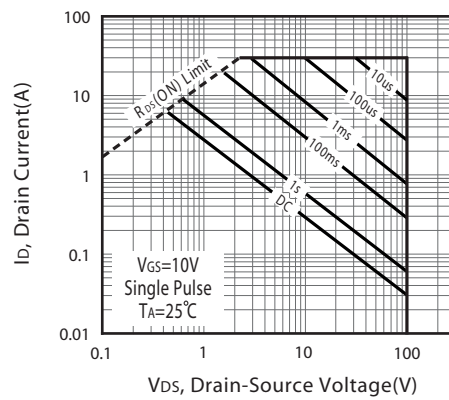
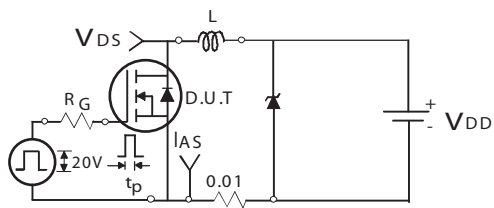
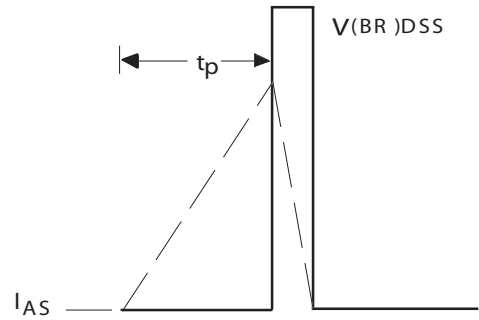

Figure 12. Maximum Safe Operating Area



Unclamped Inductive Test Circuit

Figure 13a.



Unclamped Inductive Waveforms

Figure 13b.

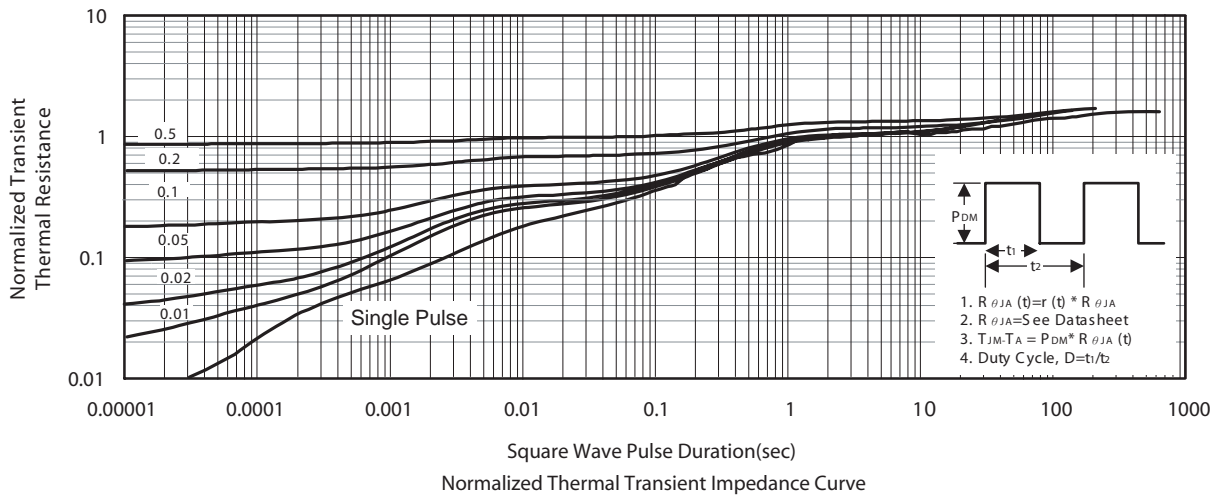

PACKAGE OUTLINE DIMENSIONS

SO-8

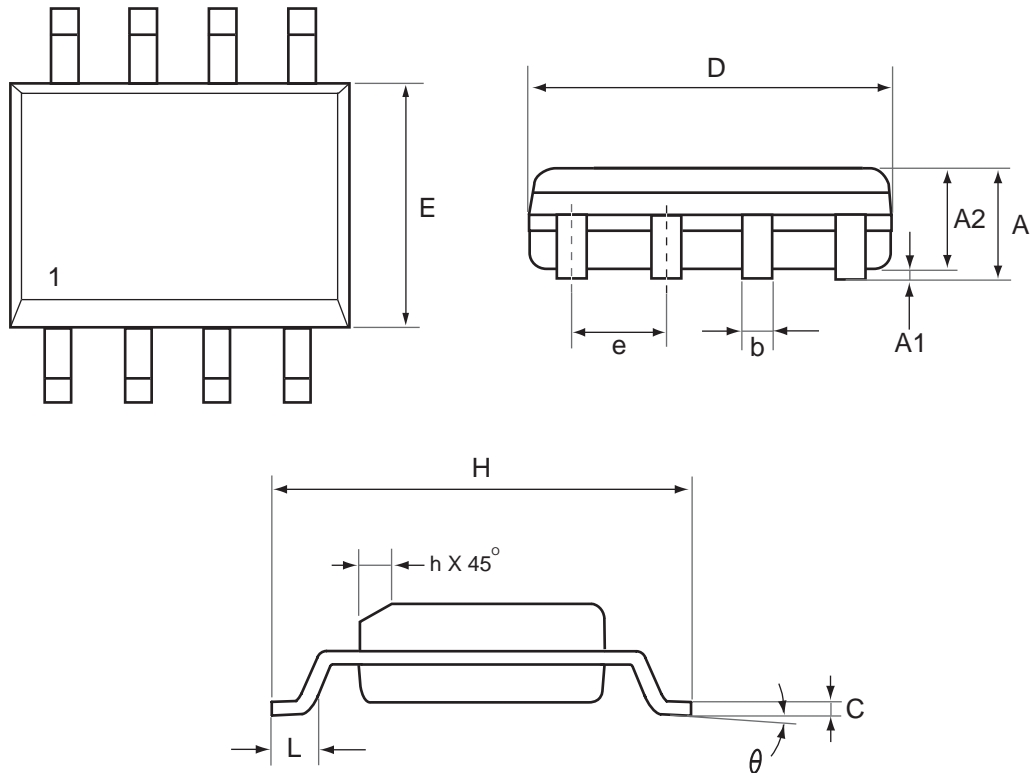

SYMBOLS	MILLIMETERS		INCHES	
	MIN	MAX	MIN	MAX
A	1.35	1.75	0.053	0.069
A1	0.10	0.25	0.004	0.010
A2	1.25	1.63	0.049	0.064
b	0.31	0.51	0.012	0.020
C	0.17	0.25	0.007	0.010
D	4.80	5.00	0.189	0.197
E	3.70	4.00	0.146	0.157
e	1.27 REF.		0.050 BSC	
H	5.80	6.20	0.228	0.244
L	0.40	1.27	0.016	0.050
θ	0°	8°	0°	8°
h	0.25	0.50	0.010	0.020

SO-8 Tape and Reel Data

SO-8 Carrier Tape

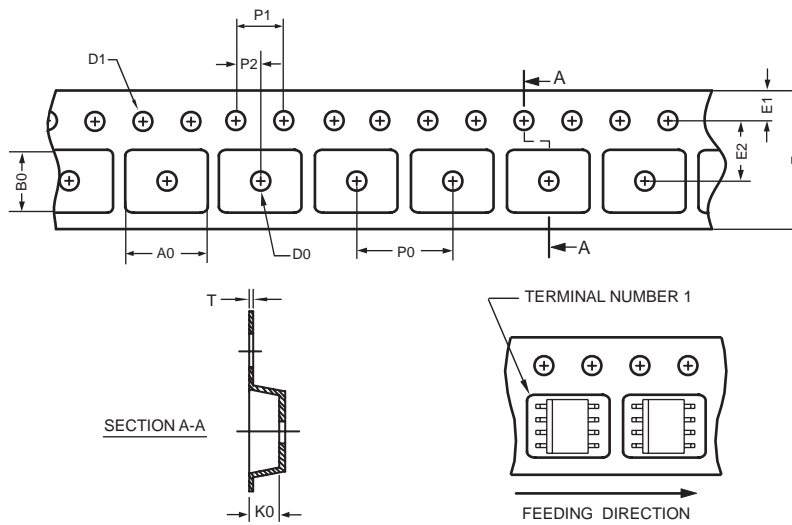

unit: mm

PACKAGE	A0	B0	K0	D0	D1	E	E1	E2	P0	P1	P2	T
SOP 8N 150mil	6.50 ±0.15	5.25 ±0.10	2.10 ±0.10	φ 1.5 (MIN)	φ 1.55 ±0.10	12.0 +0.3 -0.1	1.75 ±0.10	5.5 ±0.10	8.0 ±0.10	4.0 ±0.10	2.0 ±0.10	0.30 ±0.013

SO-8 Reel

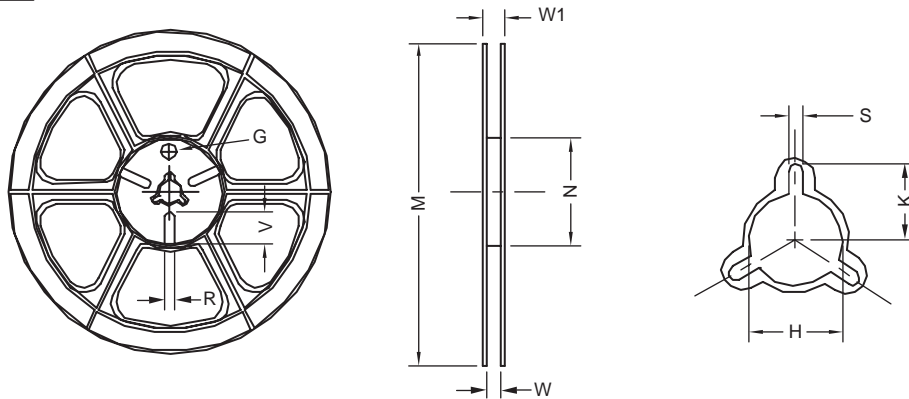

UNIT: mm

TAPE SIZE	REEL SIZE	M	N	W	W1	H	K	S	G	R	V
12 mm	φ 330	330 ± 1	62 ±1.5	12.4 + 0.2	16.8 - 0.4	φ 12.75 + 0.15	---	2.0 ±0.15	---	---	---

TOP MARKING DEFINITION

