



Dual N-Channel Enhancement Mode Field Effect Transistor

PRODUCT SUMMARY		
V _{DSS}	I _D	R _{DS(ON)} (mΩ) Max
40V	7A	26 @ V _{GS} = 10V 33 @ V _{GS} = 4.5V

FEATURES

- Super high dense cell design for low R_{DS(ON)}.
- Rugged and reliable.
- Surface Mount Package.
- ESD Protected.

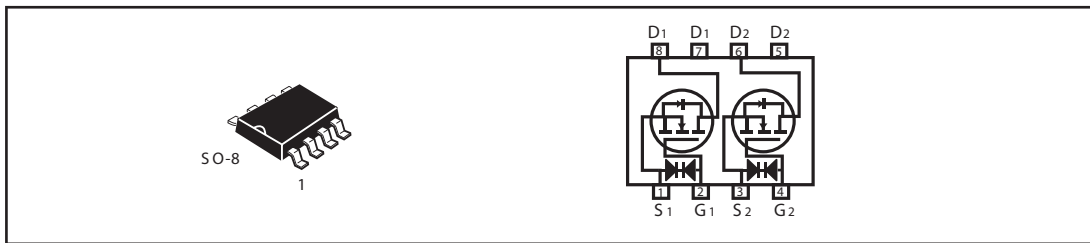

ABSOLUTE MAXIMUM RATINGS (T_A=25°C unless otherwise noted)

Parameter	Symbol	Limit	Unit	
Drain-Source Voltage	V _{DS}	40	V	
Gate-Source Voltage	V _{GS}	±20	V	
Drain Current-Continuous ^a @ T _a	I _D	25°C	7	A
		70°C	5.9	A
-Pulsed ^b	I _{DM}	28	A	
Drain-Source Diode Forward Current ^a	I _S	1.7	A	
Maximum Power Dissipation ^a	P _D	T _a =25°C	2	W
		T _a =70°C	1.44	
Operating Junction and Storage Temperature Range	T _J , T _{STG}	-55 to 150	°C	

THERMAL CHARACTERISTICS

Thermal Resistance, Junction-to-Ambient ^a	R _{θJA}	62.5	°C/W
--	------------------	------	------

STM6922

N-Channel ELECTRICAL CHARACTERISTICS (TA = 25°C unless otherwise noted)

Parameter	Symbol	Condition	Min	Typ ^c	Max	Unit
OFF CHARACTERISTICS						
Drain-Source Breakdown Voltage	BV _{DSS}	V _{GS} = 0V, I _D = 250uA	40			V
Zero Gate Voltage Drain Current	I _{DSS}	V _{DS} = 32V, V _{GS} = 0V			1	uA
Gate-Body Leakage	I _{GSS}	V _{GS} = ±20V, V _{DS} = 0V			±10	uA
ON CHARACTERISTICS^b						
Gate Threshold Voltage	V _{GS(th)}	V _{DS} = V _{GS} , I _D = 250uA	1	1.8	3	V
Drain-Source On-State Resistance	R _{DS(ON)}	V _{GS} = 10V, I _D = 6A		19	26	m ohm
		V _{GS} = 4.5V, I _D = 5A		27	33	m ohm
On-State Drain Current	I _{D(ON)}	V _{DS} = 5V, V _{GS} = 10V	15			A
Forward Transconductance	g _{FS}	V _{DS} = 5V, I _D = 6A		14		S
DYNAMIC CHARACTERISTICS^c						
Input Capacitance	C _{ISS}	V _{DS} = 20V, V _{GS} = 0V f = 1.0MHz		696		pF
Output Capacitance	C _{OSS}			123		pF
Reverse Transfer Capacitance	C _{RSS}			74		pF
SWITCHING CHARACTERISTICS^c						
Turn-On Delay Time	t _{D(ON)}	V _{DD} = 20V I _D = 1 A V _{GS} = 10V R _{GEN} = 3.3 ohm		13.5		ns
Rise Time	t _r			13		ns
Turn-Off Delay Time	t _{D(OFF)}			45		ns
Fall Time	t _f			8		ns
Total Gate Charge	Q _g	V _{DS} = 20V, I _D = 6A, V _{GS} = 10V		13.3		nC
		V _{DS} = 20V, I _D = 6A, V _{GS} = 4.5V		7		nC
Gate-Source Charge	Q _{gs}	V _{DS} = 20V, I _D = 6 A V _{GS} = 4.5V		2.2		nC
Gate-Drain Charge	Q _{gd}			3.9		nC

STM6922

ELECTRICAL CHARACTERISTICS ($T_A=25^\circ\text{C}$ unless otherwise noted)

Parameter	Symbol	Condition	Min	Typ ^c	Max	Unit
DRAIN-SOURCE DIODE CHARACTERISTICS ^b						
Diode Forward Voltage	V_{SD}	$V_{GS} = 0V, I_s = 1.7A$		0.78	1.2	V

Notes

- a. Surface Mounted on FR4 Board, $t \leq 10\text{sec}$.
- b. Pulse Test: Pulse Width $\leq 300\mu\text{s}$, Duty Cycle $\leq 2\%$.
- c. Guaranteed by design, not subject to production testing.

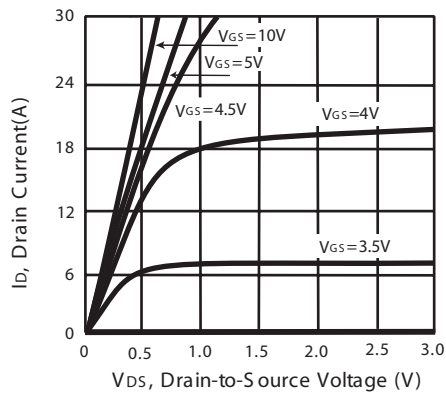

Figure 1. Output Characteristics

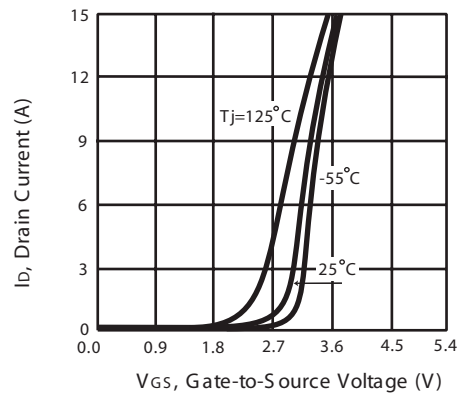

Figure 2. Transfer Characteristics

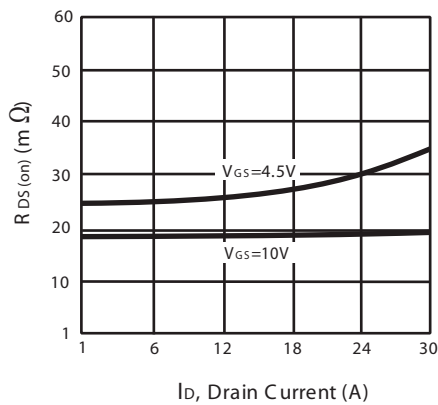

Figure 3. On-Resistance vs. Drain Current and Gate Voltage

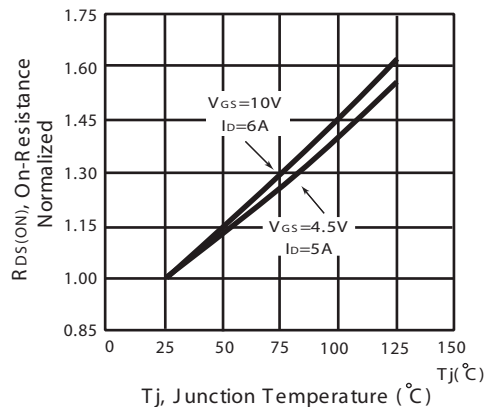

Figure 4. On-Resistance Variation with Drain Current and Temperature

STM6922

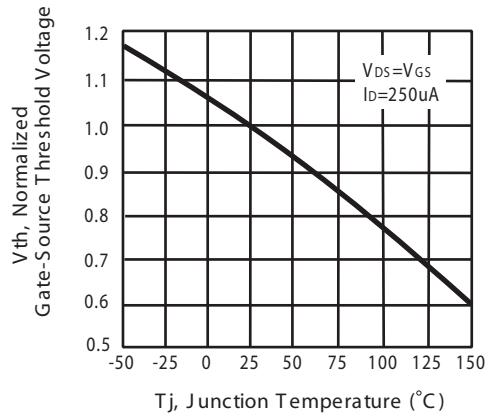

Figure 5. Gate Threshold Variation with Temperature

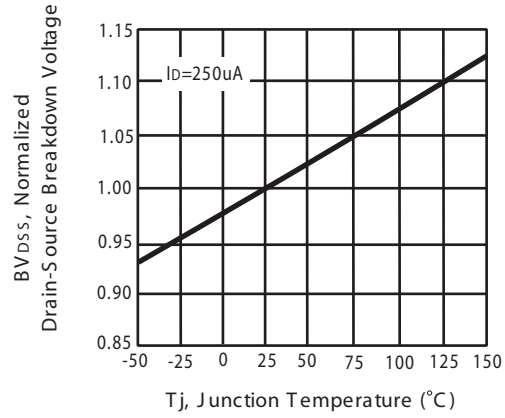

Figure 6. Breakdown Voltage Variation with Temperature

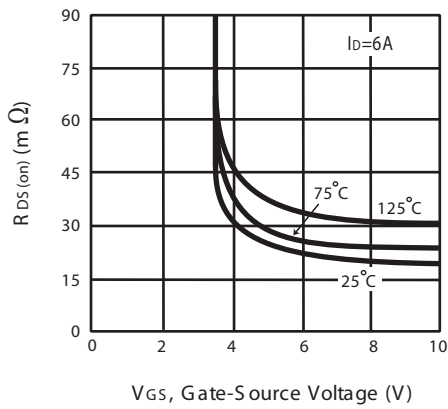

Figure 7. On-Resistance vs. Gate-Source Voltage

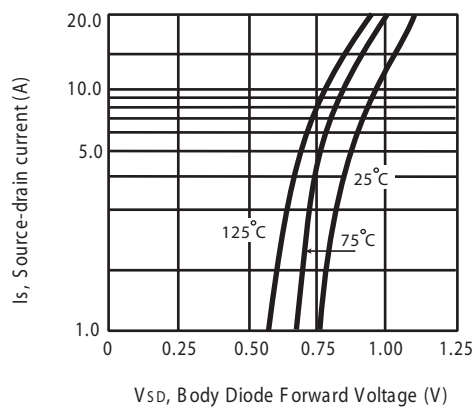

Figure 8. Body Diode Forward Voltage Variation with Source Current

STM6922

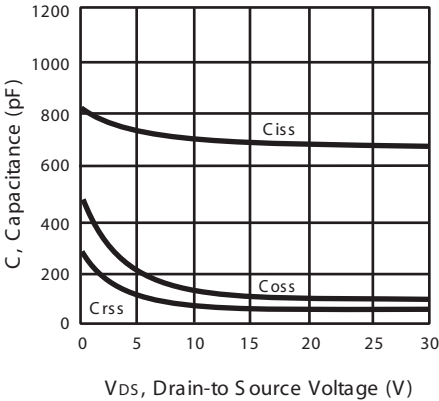

Figure 9. Capacitance

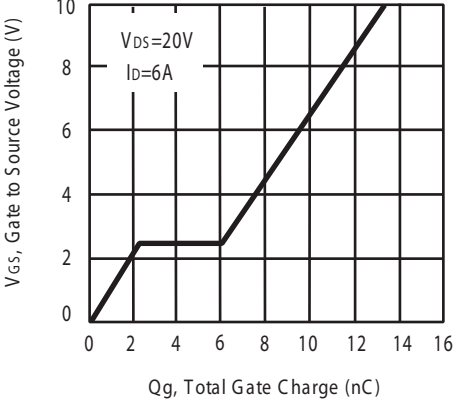

Figure 10. Gate Charge

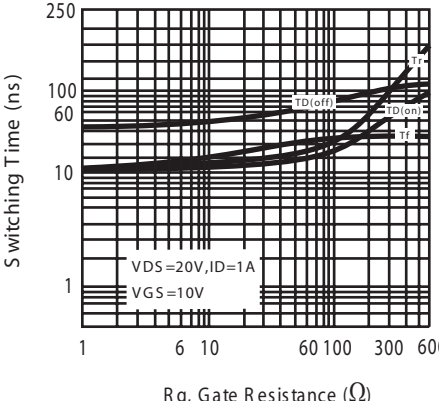

Figure 11. switching characteristics

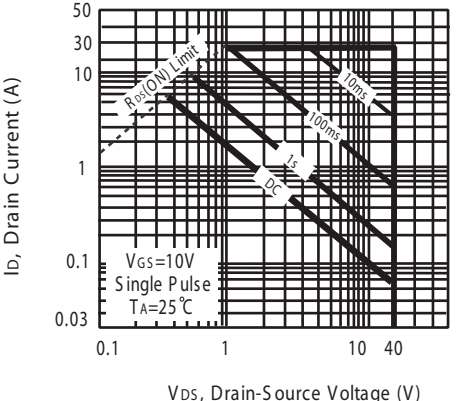
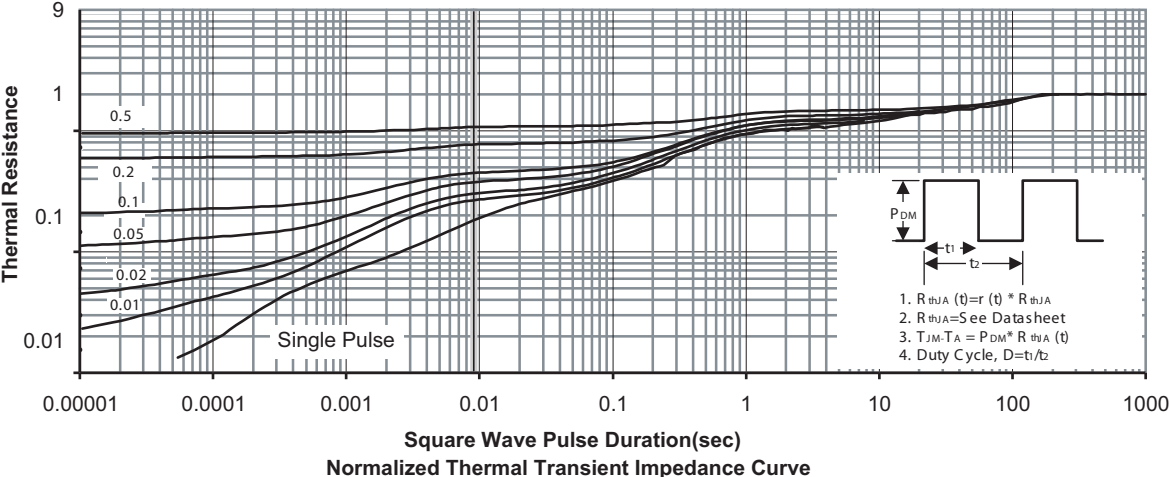

Figure 12. Maximum Safe Operating Area



STM6922

PACKAGE OUTLINE DIMENSIONS

SO-8

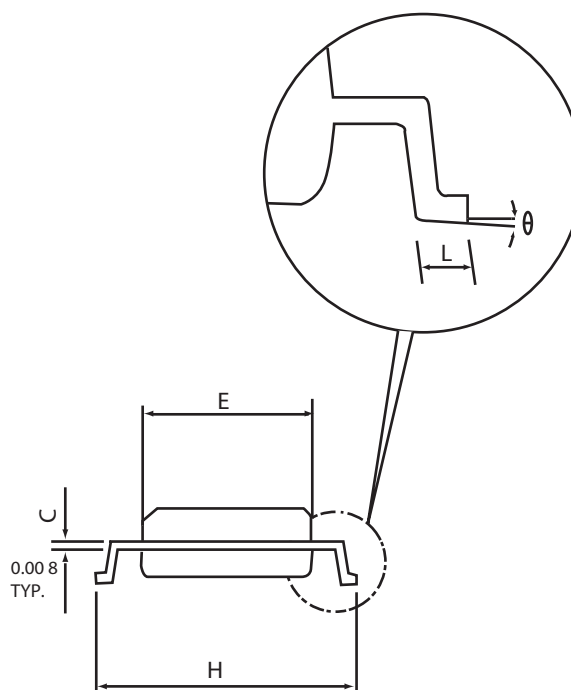
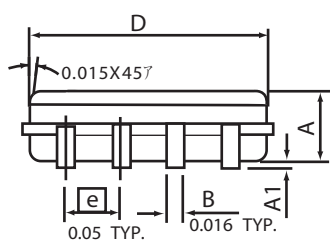
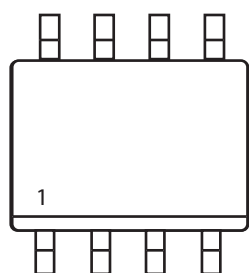

SYMBOLS	MILLIMETERS		INCHES	
	MIN	MAX	M IN	M AX
A	1.35	1.75	0.053	0.069
A1	0.10	0.25	0.004	0.010
D	4.80	4.98	0.189	0.196
E	3.81	3.99	0.150	0.157
H	5.79	6.20	0.228	0.244
L	0.41	1.27	0.016	0.050
θ	0°	8°	0°	8°

STM6922

SO-8 Tape and Reel Data

SO-8 Carrier Tape

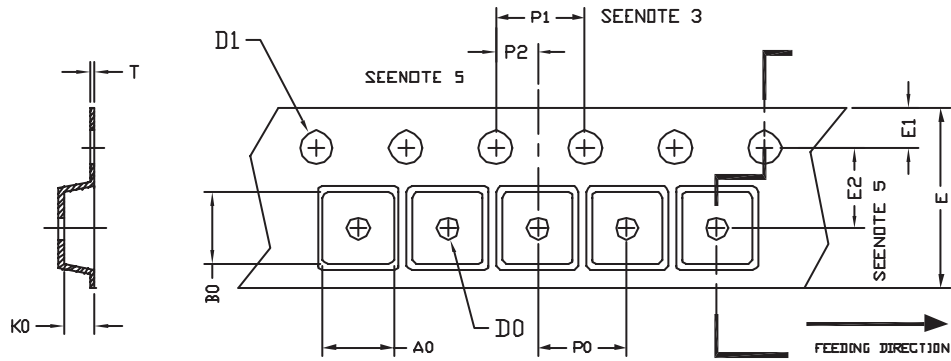

unit: b

PACKAGE	A0	B0	K0	D0	D1	E	E 1	E2	P0	P1	P2	T
SO P 8 N 150 bI	6.40	5.20	2.10	模1.5 (MIN)	模1.5 + 0.1 - 0.0	12.0 +0.3	1.75	5.5 +0.05	8.0	4.0	2.0 +0.05	0.3 +0.05

SO-8 Reel

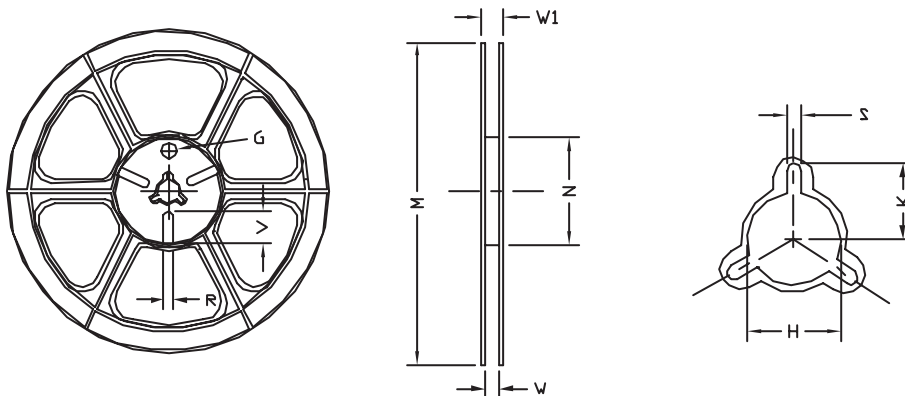

UNIT: b

TAPE SIZE	REEL SIZE	M	N	W	W1	H	K	S	G	R	V
12 b	模330	330 + 1	62 +1.5	12.4 + 0.2	16.8 - 0.4	模12.75 + 0.15	---	2.0 +0.15	---	---	---