

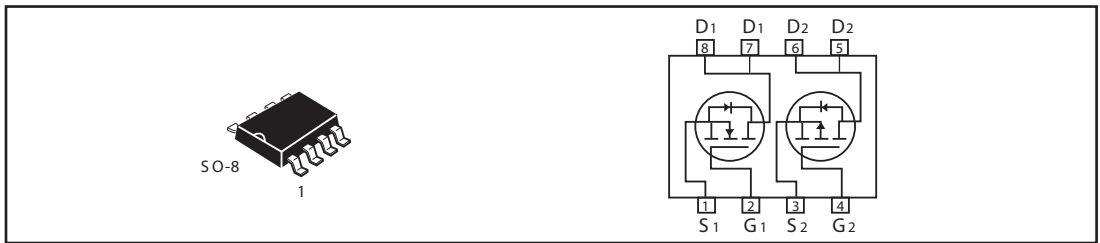

Dual Enhancement Mode Field Effect Transistor (N and P Channel)

PRODUCT SUMMARY (N-Channel)		
V _{DSS}	I _D	R _{DS(ON)} (mΩ) Max
30V	7A	26 @ V _{GS} = 10V
		35 @ V _{GS} = 4.5

PRODUCT SUMMARY (P-Channel)		
V _{DSS}	I _D	R _{DS(ON)} (mΩ) Max
-30V	-6A	38 @ V _{GS} = -10V
		52 @ V _{GS} = -4.5V



ABSOLUTE MAXIMUM RATINGS (T_A=25 °C unless otherwise noted)

Parameter	Symbol	N-Channel	P-Channel	Unit
Drain-Source Voltage	V _{DS}	30	-30	V
Gate-Source Voltage	V _{GS}	±20	±20	V
Drain Current-Continuous ^a @ T _J =25 °C -Pulsed ^b	I _D	7	-6	A
	I _{DM}	28	-24	A
Drain-Source Diode Forward Current ^a	I _S	1.7	-1.7	A
Maximum Power Dissipation ^a	P _D	2.0		W
Operating Junction and Storage Temperature Range	T _J , T _{STG}	-55 to 150		°C

THERMAL CHARACTERISTICS

Thermal Resistance, Junction-to-Ambient ^a	R _{θJA}	62.5	°C/W
--	------------------	------	------

STM8306

N-Channel ELECTRICAL CHARACTERISTICS ($T_A=25^{\circ}\text{C}$ unless otherwise noted)

Parameter	Symbol	Condition	Min	Typ ^c	Max	Unit
OFF CHARACTERISTICS						
Drain-Source Breakdown Voltage	BV_{DSS}	$V_{GS}=0V, I_D=250\mu A$	30			V
Zero Gate Voltage Drain Current	I_{DSS}	$V_{DS}=24V, V_{GS}=0V$			1	μA
Gate-Body Leakage	I_{GSS}	$V_{GS}=\pm 20V, V_{DS}=0V$			± 100	nA
ON CHARACTERISTICS^b						
Gate Threshold Voltage	$V_{GS(th)}$	$V_{DS}=V_{GS}, I_D=250\mu A$	1.0	1.7	3	V
Drain-Source On-State Resistance	$R_{DS(ON)}$	$V_{GS}=10V, I_D=7A$		20	26	m ohm
		$V_{GS}=4.5V, I_D=5A$		25	35	m ohm
On-State Drain Current	$I_{D(ON)}$	$V_{DS}=15V, V_{GS}=10V$	20			A
Forward Transconductance	g_{FS}	$V_{DS}=10V, I_D=7A$		14		S
DYNAMIC CHARACTERISTICS^c						
Input Capacitance	C_{ISS}	$V_{DS}=15V, V_{GS}=0V$ $f=1.0\text{MHz}$		610		pF
Output Capacitance	C_{OSS}			142		pF
Reverse Transfer Capacitance	C_{RSS}			95		pF
SWITCHING CHARACTERISTICS^c						
Turn-On Delay Time	$t_{D(ON)}$	$V_{DD}=15V,$ $I_D=7A,$ $R_L=2.1\text{ ohm},$ $V_{GS}=10V,$ $R_{GEN}=6\text{ ohm}$		10		ns
Rise Time	t_r			11		ns
Turn-Off Delay Time	$t_{D(OFF)}$			25		ns
Fall Time	t_f			4		ns
Total Gate Charge	Q_g	$V_{DS}=15V, I_D=7A, V_{GS}=10V$		14.6		nC
		$V_{DS}=15V, I_D=7A, V_{GS}=4.5V$		7.5		nC
Gate-Source Charge	Q_{gs}	$V_{DS}=15V, I_D=7A,$ $V_{GS}=10V$		1.7		nC
Gate-Drain Charge	Q_{gd}			4		nC

STM8306

P-Channel ELECTRICAL CHARACTERISTICS ($T_A=25^{\circ}\text{C}$ unless otherwise noted)

Parameter	Symbol	Condition	Min	Typ ^c	Max	Unit
OFF CHARACTERISTICS						
Drain-Source Breakdown Voltage	BV_{DSS}	$V_{GS}=0V, I_D=-250\mu A$	-30			V
Zero Gate Voltage Drain Current	I_{DSS}	$V_{DS}=-24V, V_{GS}=0V$			-1	μA
Gate-Body Leakage	I_{GSS}	$V_{GS}=\pm 20V, V_{DS}=0V$			± 100	nA
ON CHARACTERISTICS^b						
Gate Threshold Voltage	$V_{GS(th)}$	$V_{DS}=V_{GS}, I_D=-250\mu A$	-1	-1.7	-3	V
Drain-Source On-State Resistance	$R_{DS(ON)}$	$V_{GS}=-10V, I_D=-5A$		29	38	m ohm
		$V_{GS}=-4.5V, I_D=-4A$		42	52	m ohm
On-State Drain Current	$I_{D(ON)}$	$V_{DS}=-15V, V_{GS}=-10V$	-20			A
Forward Transconductance	g_{FS}	$V_{DS}=-15V, I_D=-5A$		9.6		S
DYNAMIC CHARACTERISTICS^c						
Input Capacitance	C_{ISS}	$V_{DS}=-15V, V_{GS}=0V$ $f=1.0\text{MHz}$		850		pF
Output Capacitance	C_{OSS}			235		pF
Reverse Transfer Capacitance	C_{RSS}			150		pF
SWITCHING CHARACTERISTICS^c						
Turn-On Delay Time	$t_{D(ON)}$	$V_D=-15V,$ $R_L=15\text{ ohm},$ $I_D=-1A,$ $V_{GEN}=-10V,$ $R_{GEN}=6\text{ ohm}$		11		ns
Rise Time	t_r			23		ns
Turn-Off Delay Time	$t_{D(OFF)}$			45		ns
Fall Time	t_f			48		ns
Total Gate Charge	Q_g	$V_{DS}=-15V, I_D=-5A, V_{GS}=-10V$		17.1		nC
		$V_{DS}=-15V, I_D=-5A, V_{GS}=-4.5V$		9.3		nC
Gate-Source Charge	Q_{gs}	$V_{DS}=-15V, I_D=-5A,$ $V_{GS}=-10V$		1.5		nC
Gate-Drain Charge	Q_{gd}			5.5		nC

STM8306

ELECTRICAL CHARACTERISTICS ($T_A=25^{\circ}\text{C}$ unless otherwise noted)

Parameter	Symbol	Condition	Min	Typ ^c	Max	Unit	
DRAIN-SOURCE DIODE CHARACTERISTICS^b							
Diode Forward Voltage	V_{SD}	$V_{GS} = 0\text{V}, I_s = 1.7\text{A}$	N-Ch		0.79	1.2	V
		$V_{GS} = 0\text{V}, I_s = -1.7\text{A}$	P-Ch		-0.77	-1.2	

Notes

- a. Surface Mounted on FR4 Board, $t \leq 10\text{sec}$.
 - b. Pulse Test: Pulse Width $\leq 300 \mu\text{s}$, Duty Cycle $\leq 2\%$.
 - c. Guaranteed by design, not subject to production testing.
- N-Channel

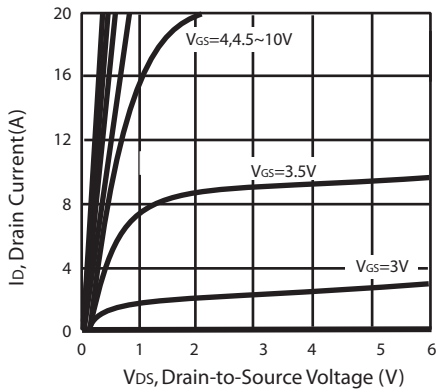

Figure 1. Output Characteristics

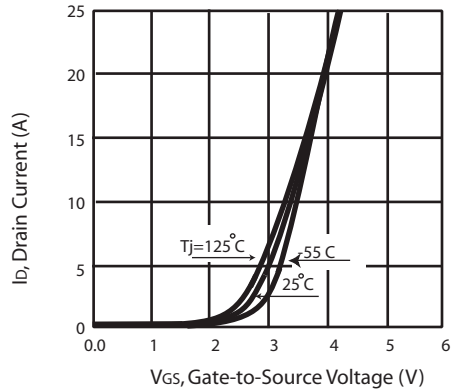

Figure 2. Transfer Characteristics

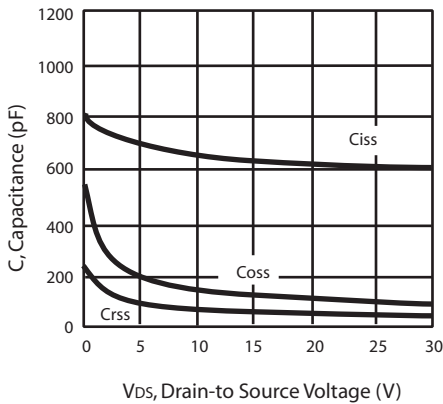

Figure 3. Capacitance

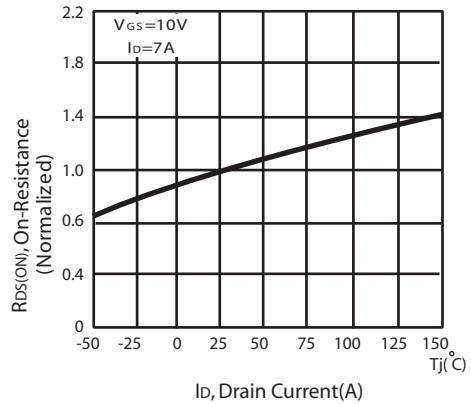

Figure 4. On-Resistance Variation with Drain Current and Temperature

STM8306

N-Channel

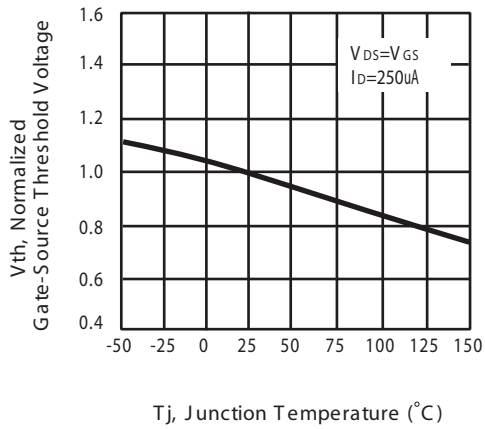

Figure 5. Gate Threshold Variation with Temperature

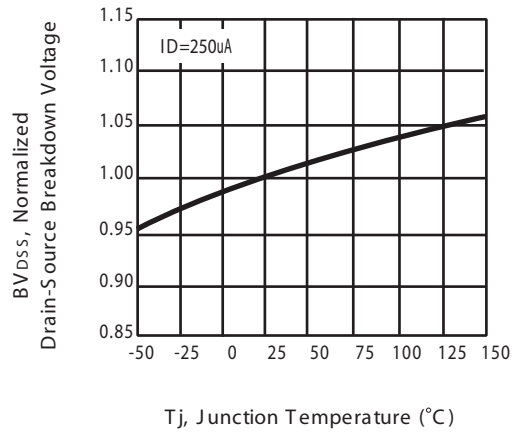

Figure 6. Breakdown Voltage Variation with Temperature

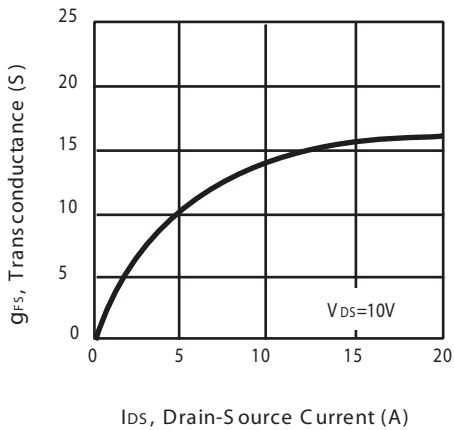

Figure 7. Transconductance Variation with Drain Current

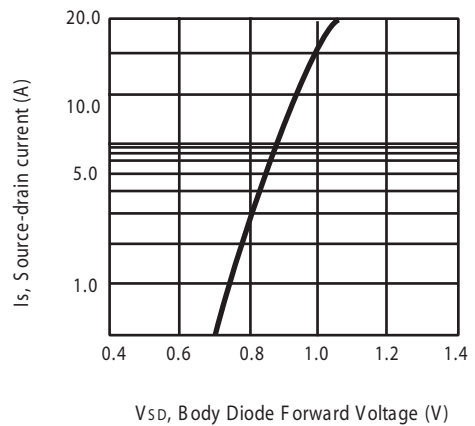

Figure 8. Body Diode Forward Voltage Variation with Source Current

STM8306

P-Channel

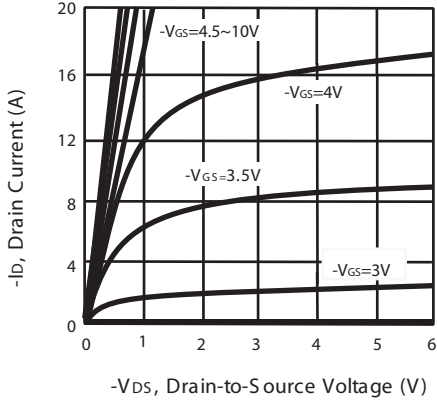

Figure 1. Output Characteristics

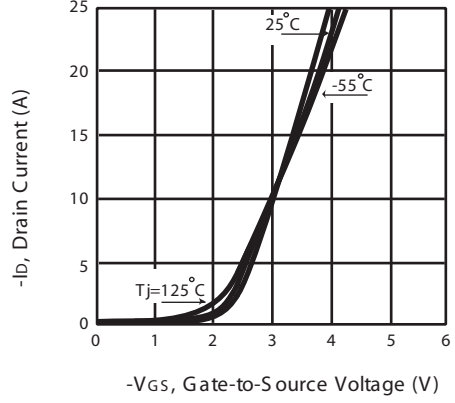

Figure 2. Transfer Characteristics

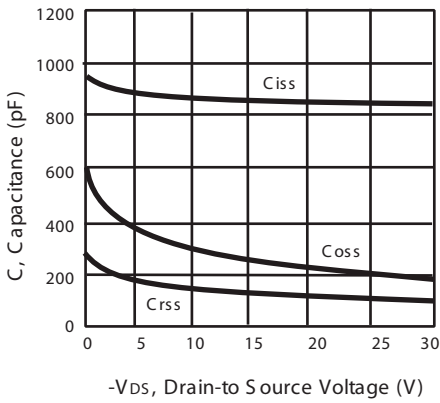

Figure 3. Capacitance

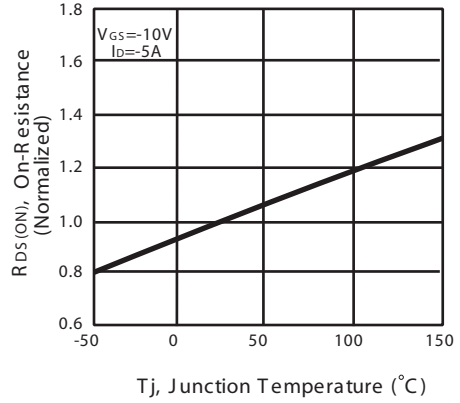

Figure 4. On-Resistance Variation with Temperature

STM8306

P-Channel

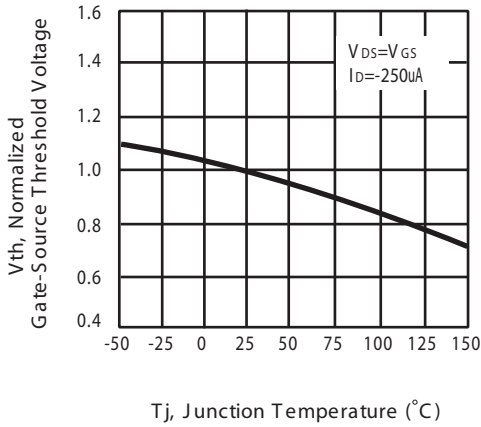

Figure 5. Gate Threshold Variation with Temperature

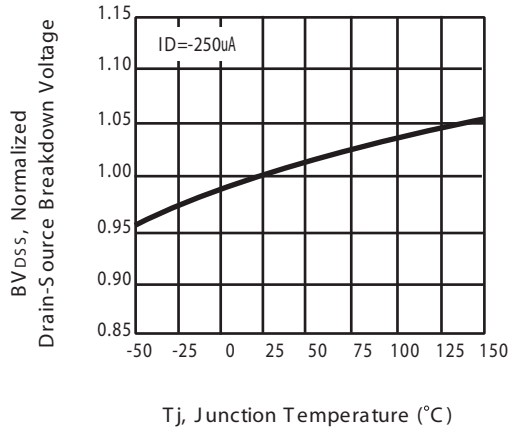

Figure 6. Breakdown Voltage Variation with Temperature

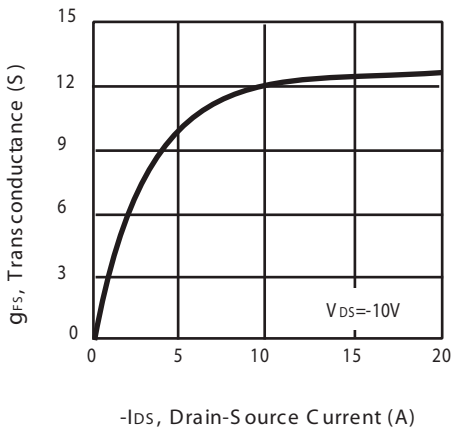

Figure 7. Transconductance Variation with Drain Current

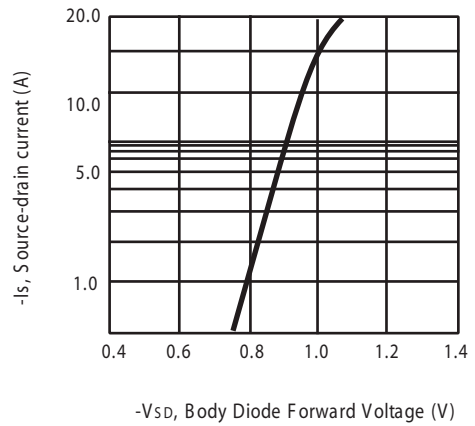
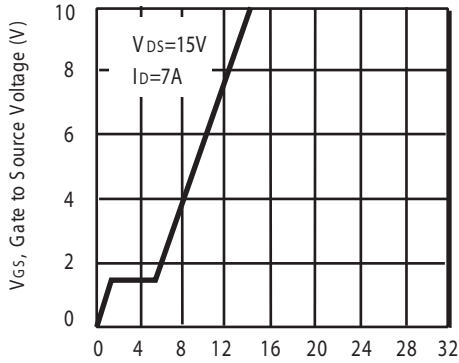

Figure 8. Body Diode Forward Voltage Variation with Source Current

STM8306

N-Channel



Qg, Total Gate Charge (nC)
Figure 9. Gate Charge

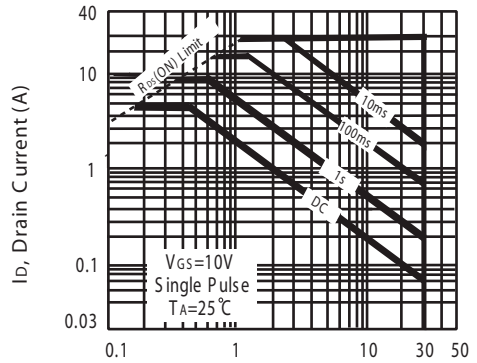

Vds, Drain-Source Voltage (V)
Figure 10. Maximum Safe Operating Area

P-Channel

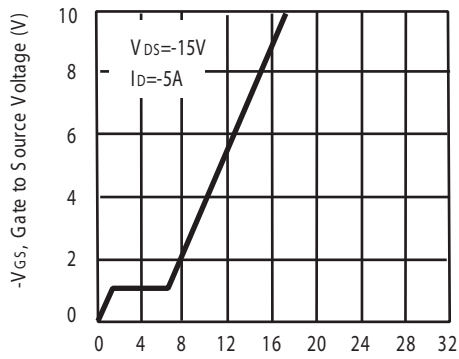

Qg, Total Gate Charge (nC)
Figure 9. Gate Charge

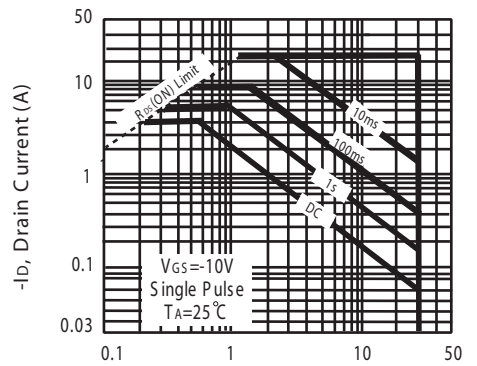

-Vds, Body Diode Forward Voltage (V)
Figure 10. Maximum Safe Operating Area

STM8306

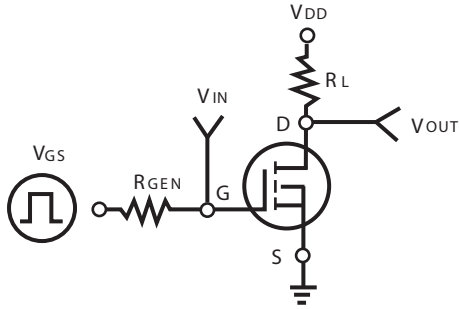

Figure 11. Switching Test Circuit

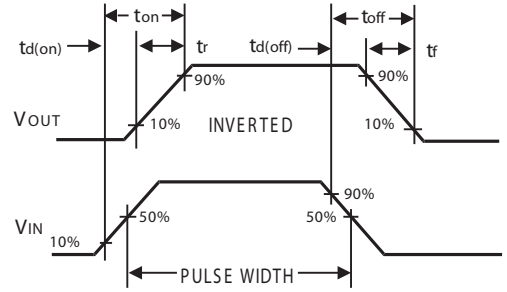
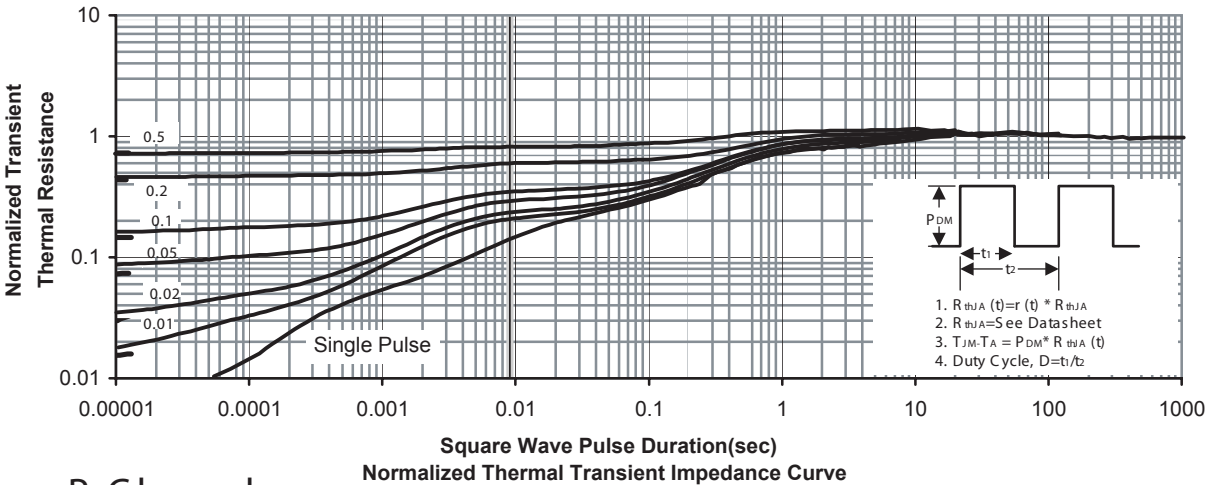
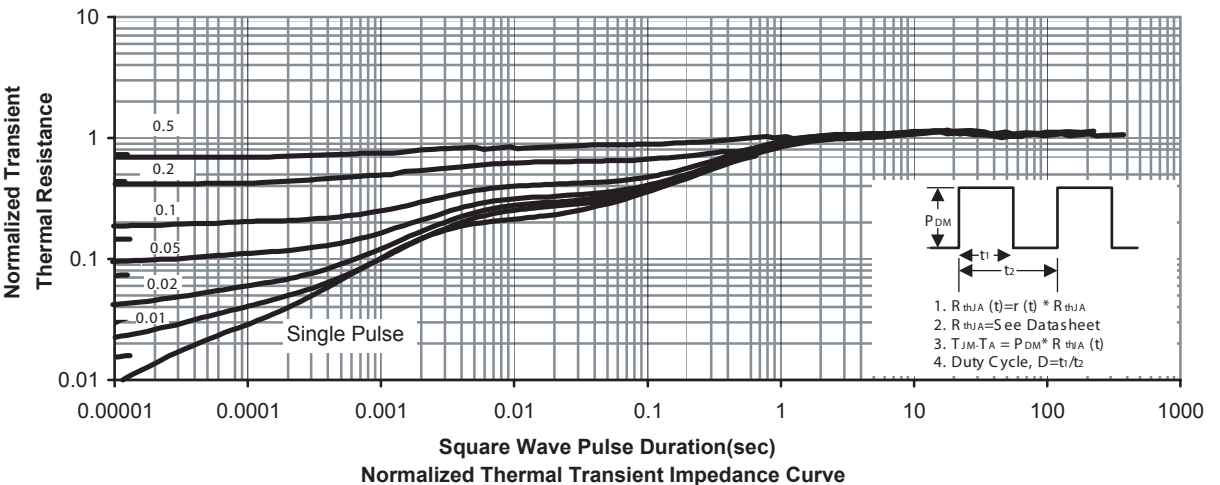

Figure 12. Switching Waveforms

N-Channel



P-Channel



STM8306

PACKAGE OUTLINE DIMENSIONS

SO-8

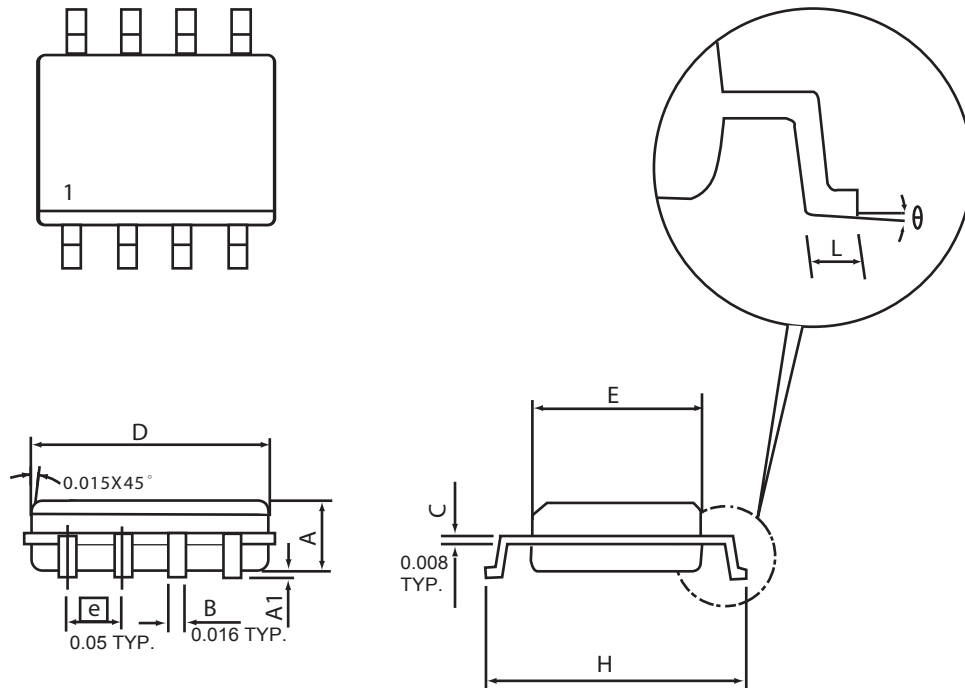

SYMBOLS	MILLIMETERS		INCHES	
	MIN	MAX	MIN	MAX
A	1.35	1.75	0.053	0.069
A1	0.10	0.25	0.004	0.010
D	4.80	4.98	0.189	0.196
E	3.81	3.99	0.150	0.157
H	5.79	6.20	0.228	0.244
L	0.41	1.27	0.016	0.050
θ	0°	8°	0°	8°

STM8306

SO-8 Tape and Reel Data

SO-8 Carrier Tape

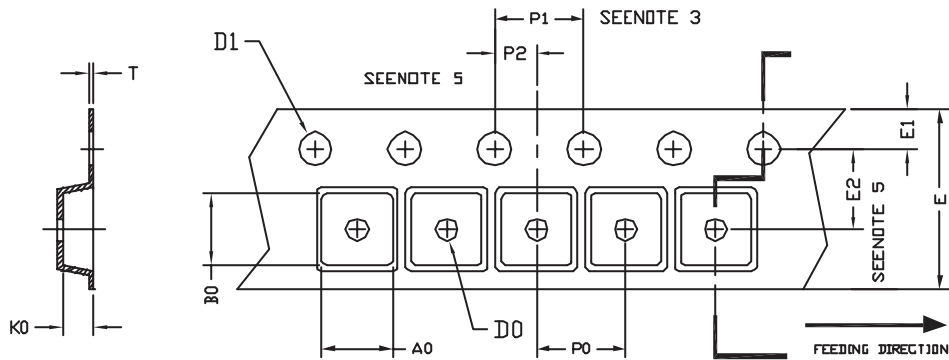

unit:mm

PACKAGE	A0	B0	K0	D0	D1	E	E1	E2	P0	P1	P2	T
SOP 8N 150mil	6.40	5.20	2.10	ϕ 1.5 (MIN)	ϕ 1.5 + 0.1 - 0.0	12.0 \pm 0.3	1.75	5.5 \pm 0.05	8.0	4.0	2.0 \pm 0.05	0.3 \pm 0.05

SO-8 Reel

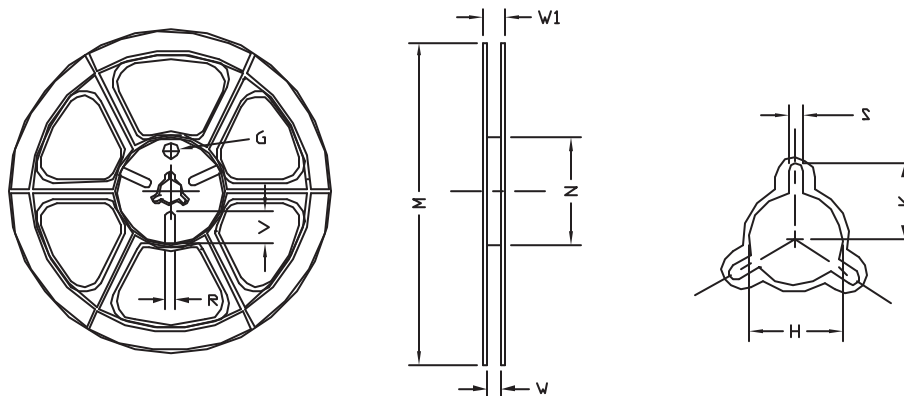

UNIT:mm

TAPE SIZE	REEL SIZE	M	N	W	W1	H	K	S	G	R	V
12 mm	ϕ 330	330 \pm 1	62 \pm 1.5	12.4 + 0.2	16.8 - 0.4	ϕ 12.75 + 0.15	---	2.0 \pm 0.15	---	---	---