

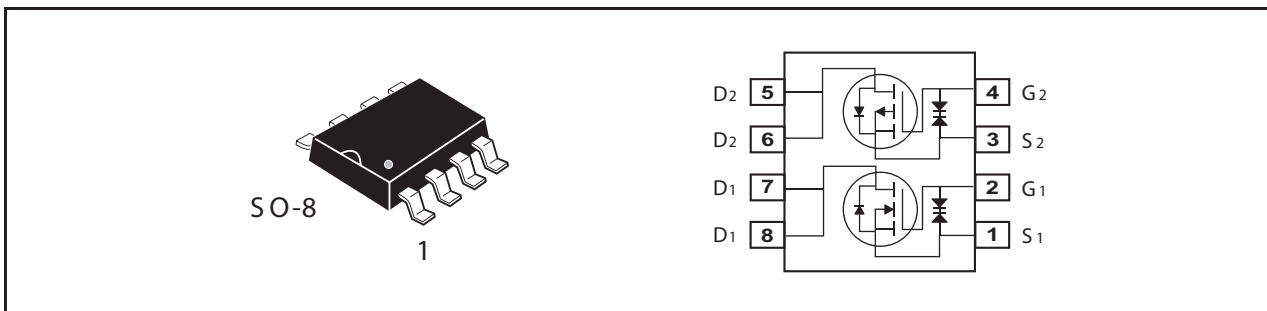

Dual Enhancement Mode Field Effect Transistor (N and P Channel)

PRODUCT SUMMARY (N-Channel)		
VDSS	ID	RDS(ON) (mΩ) Max
30V	6.5A	31 @ VGS=10V
		42 @ VGS=4.5V

PRODUCT SUMMARY (P-Channel)		
VDSS	ID	RDS(ON) (mΩ) Max
-30V	-6A	35 @ VGS=-10V
		53 @ VGS=-4.5V



ABSOLUTE MAXIMUM RATINGS (TA=25°C unless otherwise noted)

Symbol	Parameter	N-Channel	P-Channel	Units	
V _{DS}	Drain-Source Voltage	30	-30	V	
V _{GS}	Gate-Source Voltage	±20	±20	V	
I _D	Drain Current-Continuous ^a	T _A =25°C	6.5	-6	A
		T _A =70°C	5.2	-4.8	A
I _{DM}	-Pulsed ^b	24	-22	A	
E _{AS}	Single Pulse Avalanche Energy ^d	12	64	mJ	
P _D	Maximum Power Dissipation ^a	T _A =25°C	2	W	
		T _A =70°C	1.28		
T _J , T _{STG}	Operating Junction and Storage Temperature Range	-55 to 150		°C	

THERMAL CHARACTERISTICS

R _{θJA}	Thermal Resistance, Junction-to-Ambient ^a	62.5	°C/W
------------------	--	------	------

STM8324

Ver 1.0

N-Channel ELECTRICAL CHARACTERISTICS (TA=25°C unless otherwise noted)

Symbol	Parameter	Conditions	Min	Typ	Max	Units
OFF CHARACTERISTICS						
BV _{DSS}	Drain-Source Breakdown Voltage	V _{GS} =0V, I _D =250μA	30			V
I _{DSS}	Zero Gate Voltage Drain Current	V _{DS} =24V, V _{GS} =0V			1	μA
I _{GSS}	Gate-Body Leakage Current	V _{GS} = ±20V, V _{DS} =0V			±10	μA
ON CHARACTERISTICS						
V _{GS(th)}	Gate Threshold Voltage	V _{DS} =V _{GS} , I _D =250μA	1	1.9	3	V
R _{DS(ON)}	Drain-Source On-State Resistance	V _{GS} =10V, I _D =6.5A		24	31	m ohm
		V _{GS} =4.5V, I _D =5.3A		33	42	m ohm
g _{FS}	Forward Transconductance	V _{DS} =5V, I _D =6.5A		17		S
DYNAMIC CHARACTERISTICS ^c						
C _{ISS}	Input Capacitance	V _{DS} =15V, V _{GS} =0V f=1.0MHz		505		pF
C _{OSS}	Output Capacitance			100		pF
C _{RSS}	Reverse Transfer Capacitance			60		pF
SWITCHING CHARACTERISTICS ^c						
t _{D(ON)}	Turn-On Delay Time	V _{DD} =15V I _D =1A V _{GS} =10V R _{GEN} =6 ohm		12.5		ns
t _r	Rise Time			10		ns
t _{D(OFF)}	Turn-Off Delay Time			16.5		ns
t _f	Fall Time			13		ns
Q _g	Total Gate Charge	V _{DS} =15V, I _D =6.5A, V _{GS} =10V		8.8		nC
		V _{DS} =15V, I _D =6.5A, V _{GS} =4.5V		4.3		nC
Q _{gs}	Gate-Source Charge	V _{DS} =15V, I _D =6.5A, V _{GS} =10V		1.7		nC
Q _{gd}	Gate-Drain Charge			2.2		nC
DRAIN-SOURCE DIODE CHARACTERISTICS						
I _S	Maximum Continuous Drain-Source Diode Forward Current				1.7	A
V _{SD}	Diode Forward Voltage ^b	V _{GS} =0V, I _S =1.7A		0.81	1.2	V

Feb,04,2009

P-Channel ELECTRICAL CHARACTERISTICS (T_A=25°C unless otherwise noted)

Symbol	Parameter	Conditions	Min	Typ	Max	Units
OFF CHARACTERISTICS						
BV _{DSS}	Drain-Source Breakdown Voltage	V _{GS} =0V , I _D =-250uA	-30			V
I _{DSS}	Zero Gate Voltage Drain Current	V _{DS} =-24V , V _{GS} =0V			-1	uA
I _{GSS}	Gate-Body Leakage Current	V _{GS} = ±20V , V _{DS} =0V			±10	uA
ON CHARACTERISTICS						
V _{GS(th)}	Gate Threshold Voltage	V _{DS} =V _{GS} , I _D =-250uA	-1.0	-1.8	-3.0	V
R _{DS(ON)}	Drain-Source On-State Resistance	V _{GS} =-10V , I _D =-6A		27	35	m ohm
		V _{GS} =-4.5V , I _D =-4.9A		40	53	m ohm
g _{FS}	Forward Transconductance	V _{DS} =-5V , I _D =-6A		12		S
DYNAMIC CHARACTERISTICS [°]						
C _{ISS}	Input Capacitance	V _{DS} =-15V, V _{GS} =0V f=1.0MHz		825		pF
C _{OSS}	Output Capacitance			220		pF
C _{RSS}	Reverse Transfer Capacitance			130		pF
SWITCHING CHARACTERISTICS [°]						
t _{D(ON)}	Turn-On Delay Time	V _{DD} =-15V I _D =-1A		13.5		ns
t _r	Rise Time			16.5		ns
t _{D(OFF)}	Turn-Off Delay Time	V _{GS} =-10V R _{GEN} =6 ohm		64		ns
t _f	Fall Time			17		ns
Q _g	Total Gate Charge	V _{DS} =-15V, I _D =-6A, V _{GS} =-10V		16		nC
		V _{DS} =-15V, I _D =-6A, V _{GS} =-4.5V		8		nC
Q _{gs}	Gate-Source Charge	V _{DS} =-15V, I _D =-6A,		1.7		nC
Q _{gd}	Gate-Drain Charge	V _{GS} =-10V		4.5		nC
DRAIN-SOURCE DIODE CHARACTERISTICS						
I _S	Maximum Continuous Drain-Source Diode Forward Current				-1.7	A
V _{SD}	Diode Forward Voltage ^b	V _{GS} =0V, I _S =-1.7A		-0.77	-1.2	V

Notes

- Surface Mounted on FR4 Board, t ≤ 10sec.
- Pulse Test: Pulse Width ≤ 300us, Duty Cycle ≤ 2%.
- Guaranteed by design, not subject to production testing.
- Starting T_J=25°C, V_{DD} = 20V, V_{GS}=10V, L=0.5mH. (See Figure 13)

N-Channel

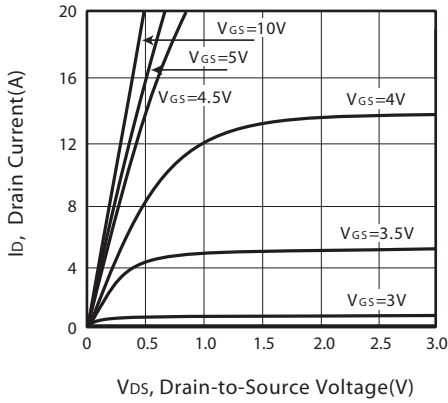

Figure 1. Output Characteristics

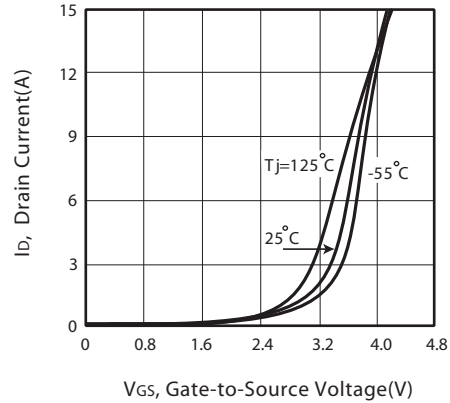

Figure 2. Transfer Characteristics

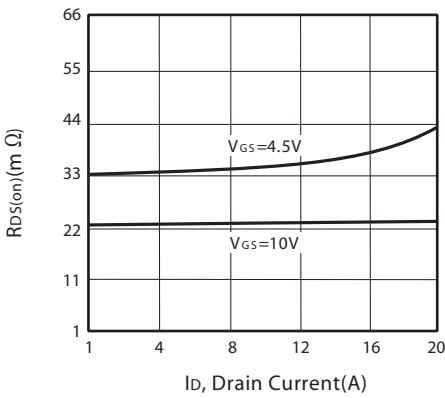

Figure 3. On-Resistance vs. Drain Current and Gate Voltage

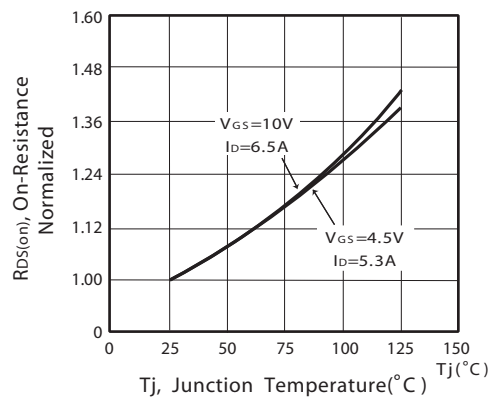

Figure 4. On-Resistance Variation with Drain Current and Temperature

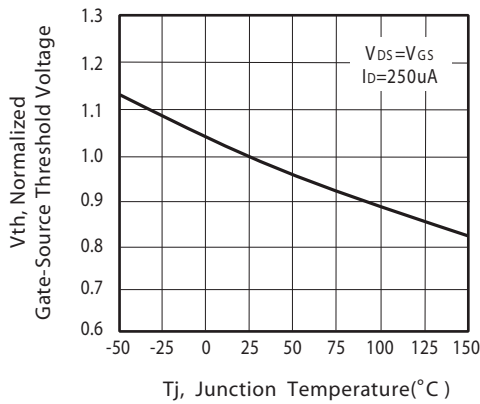

Figure 5. Gate Threshold Variation with Temperature

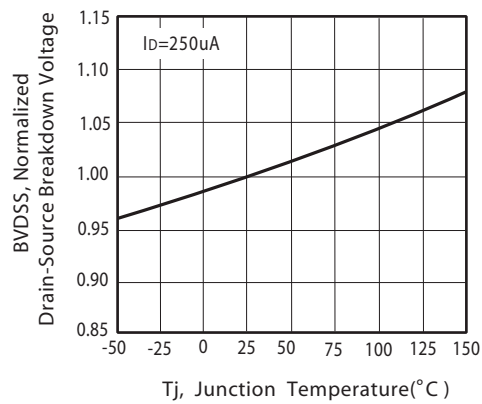

Figure 6. Breakdown Voltage Variation with Temperature

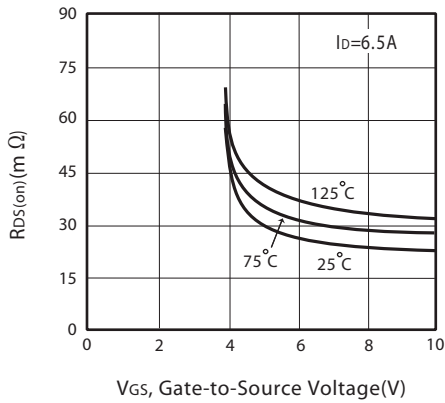

Figure 7. On-Resistance vs. Gate-Source Voltage

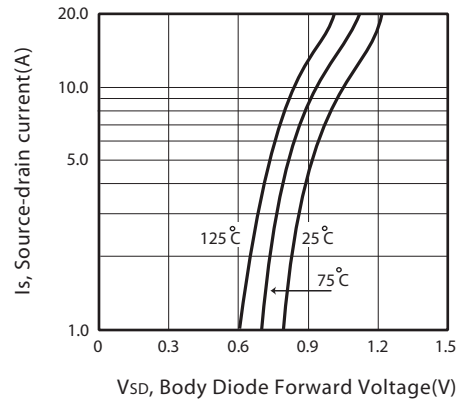

Figure 8. Body Diode Forward Voltage Variation with Source Current

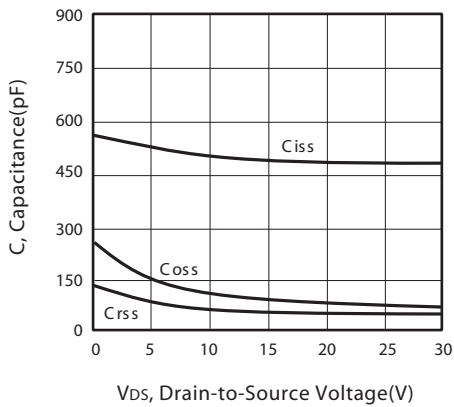

Figure 9. Capacitance

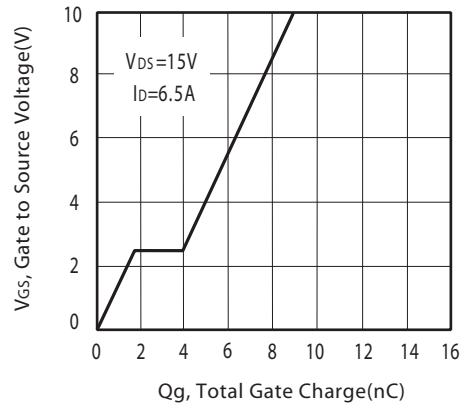

Figure 10. Gate Charge

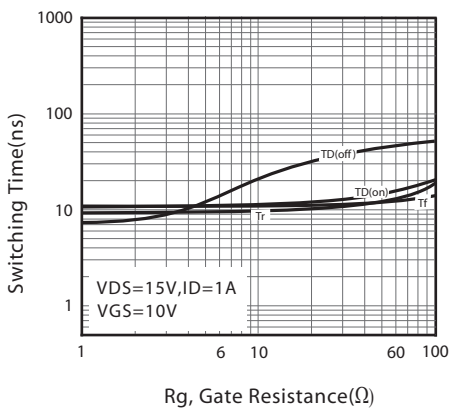

Figure 11. switching characteristics

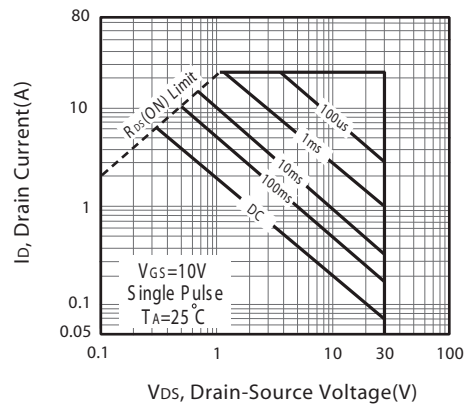
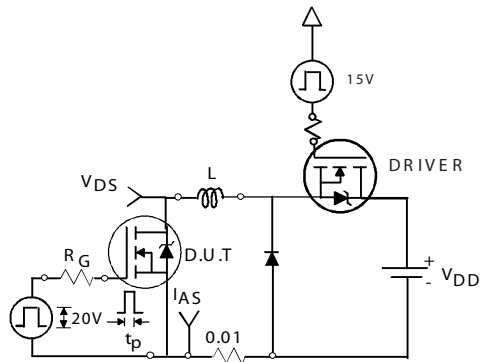
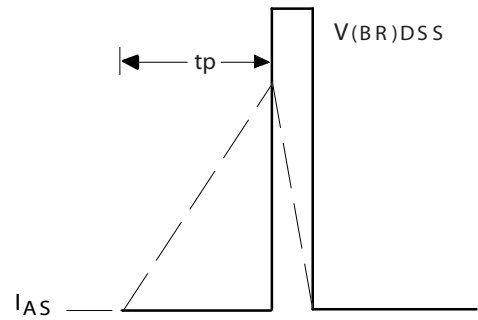

Figure 12. Maximum Safe Operating Area



Unclamped Inductive Test Circuit

Figure 13a.



Unclamped Inductive Waveforms

Figure 13b.

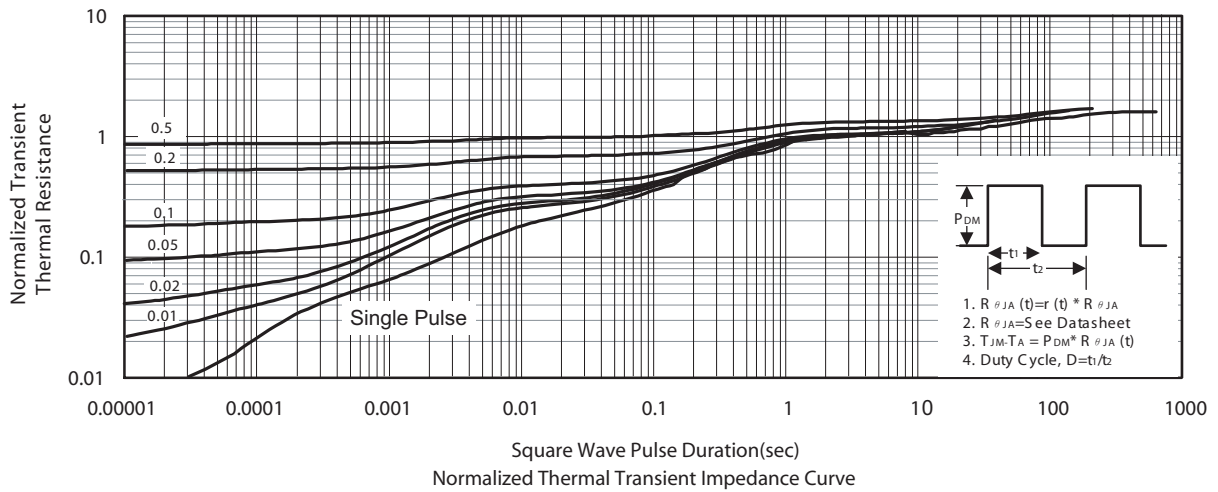

P-Channel

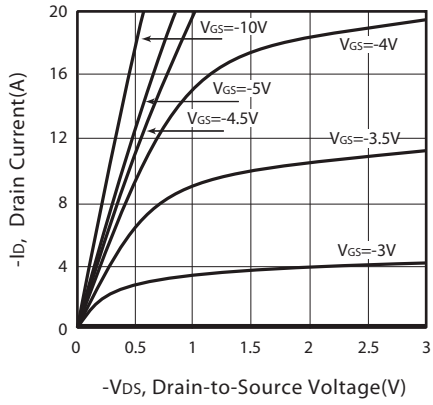

Figure 1. Output Characteristics

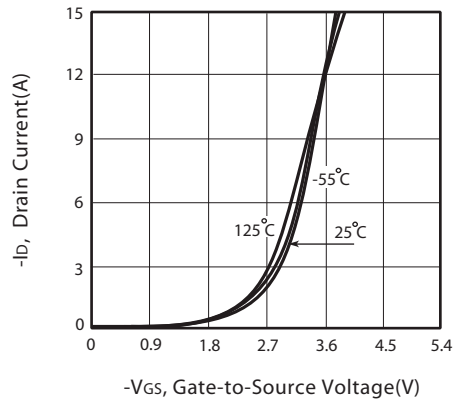

Figure 2. Transfer Characteristics

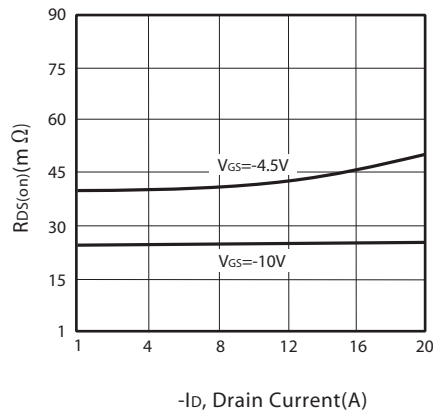

Figure 3. On-Resistance vs. Drain Current and Gate Voltage

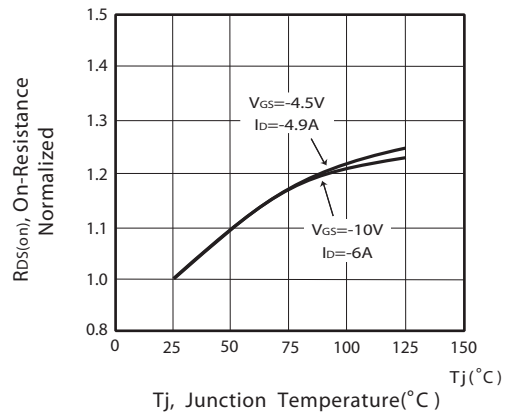

Figure 4. On-Resistance Variation with Drain Current and Temperature

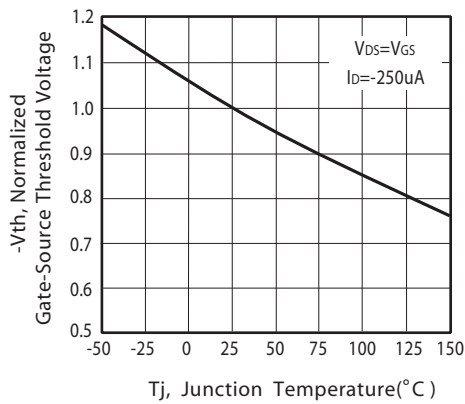

Figure 5. Gate Threshold Variation with Temperature

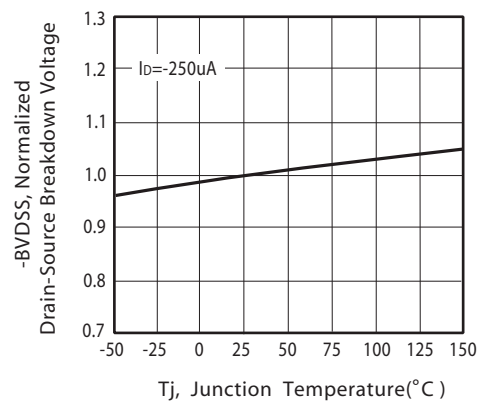

Figure 6. Breakdown Voltage Variation with Temperature

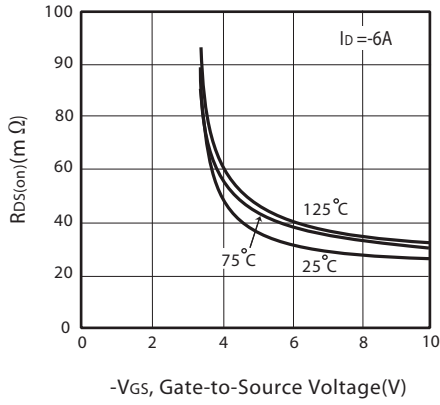

Figure 7. On-Resistance vs. Gate-Source Voltage

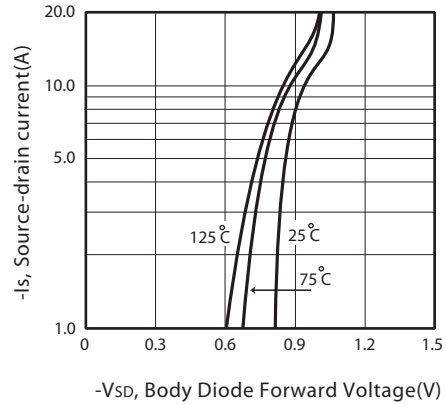

Figure 8. Body Diode Forward Voltage Variation with Source Current

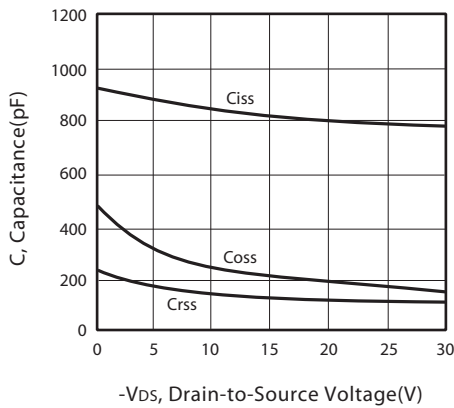

Figure 9. Capacitance

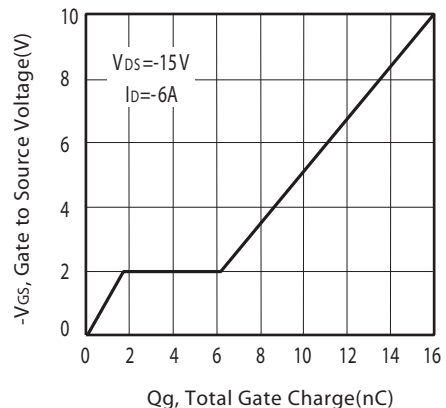

Figure 10. Gate Charge

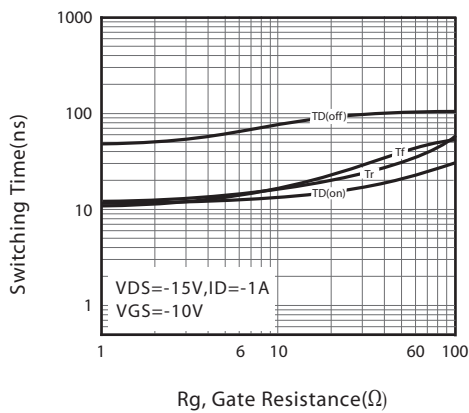

Figure 11. switching characteristics

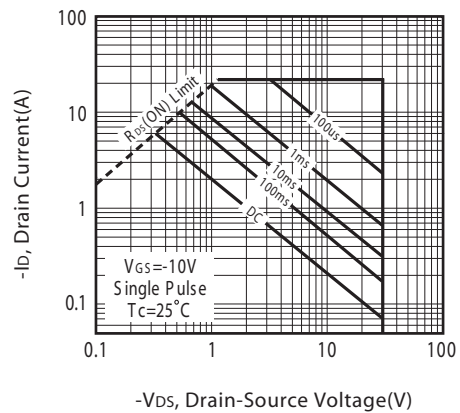
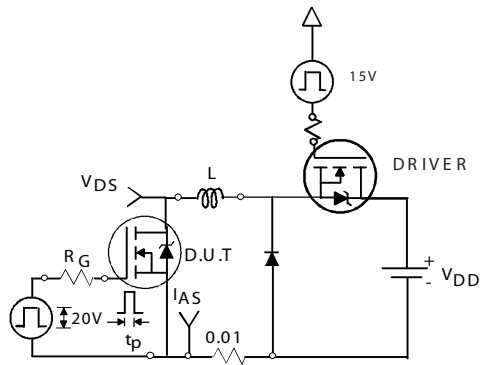
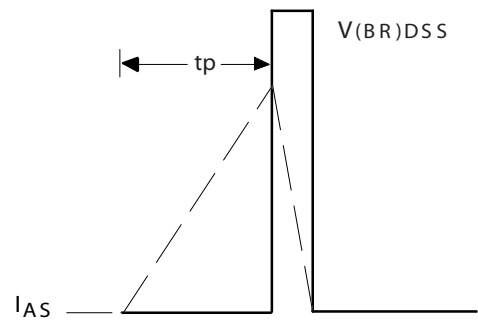

Figure 12. Maximum Safe Operating Area



Unclamped Inductive Test Circuit

Figure 13a.



Unclamped Inductive Waveforms

Figure 13b.

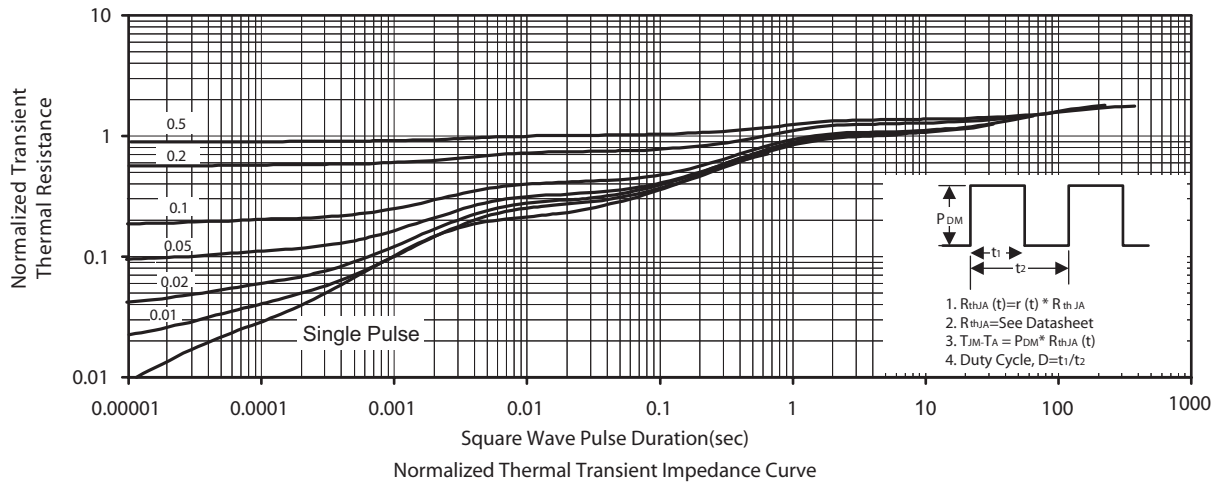

PACKAGE OUTLINE DIMENSIONS

SO-8

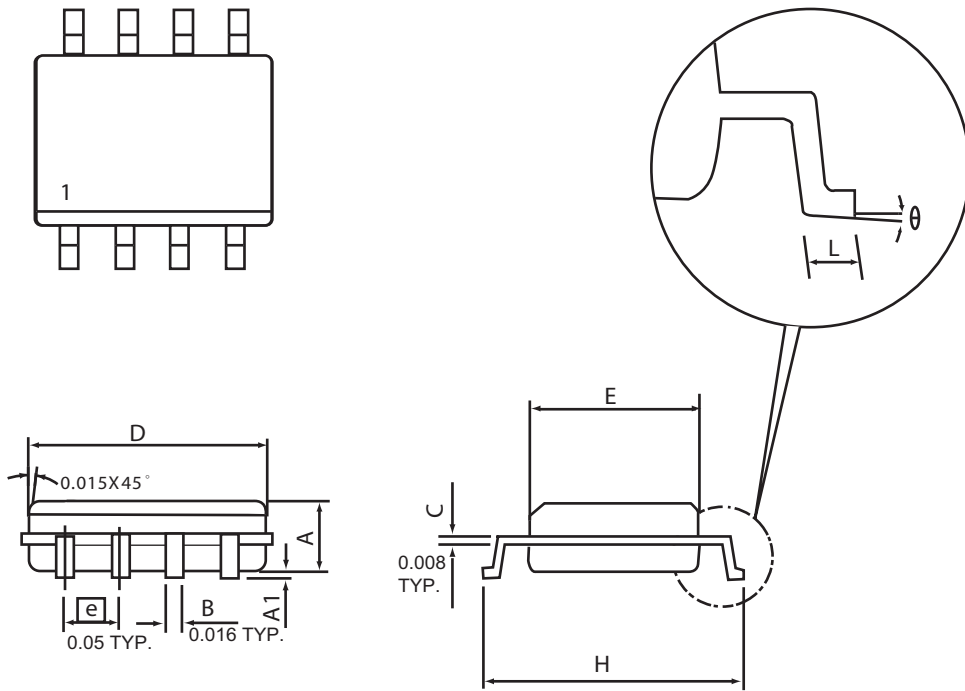

SYMBOLS	MILLIMETERS		INCHES	
	MIN	MAX	MIN	MAX
A	1.35	1.75	0.053	0.069
A1	0.10	0.25	0.004	0.010
D	4.80	4.98	0.189	0.196
E	3.81	3.99	0.150	0.157
H	5.79	6.20	0.228	0.244
L	0.41	1.27	0.016	0.050
θ	0°	8°	0°	8°

SO-8 Tape and Reel Data

SO-8 Carrier Tape

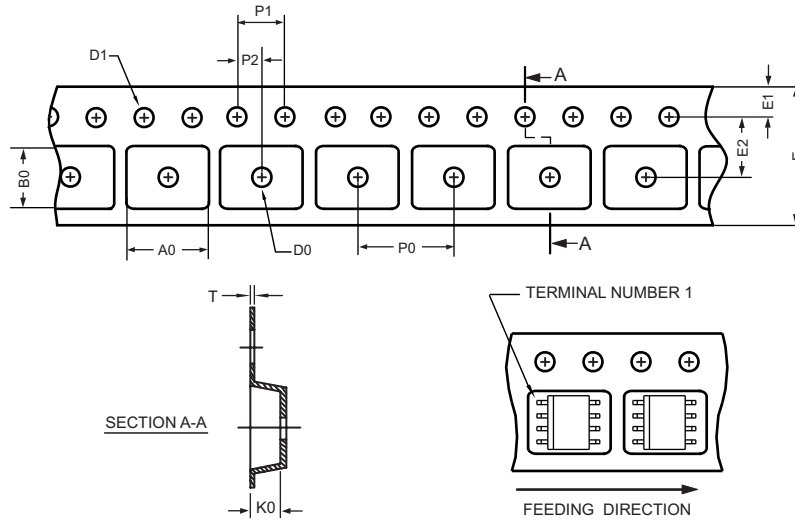

unit:mm

PACKAGE	A0	B0	K0	D0	D1	E	E1	E2	P0	P1	P2	T
SOP 8N 150mil	6.50 ±0.15	5.25 ±0.10	2.10 ±0.10	φ 1.5 (MIN)	φ 1.55 ±0.10	12.0 +0.3 -0.1	1.75 ±0.10	5.5 ±0.10	8.0 ±0.10	4.0 ±0.10	2.0 ±0.10	0.30 ±0.013

SO-8 Reel

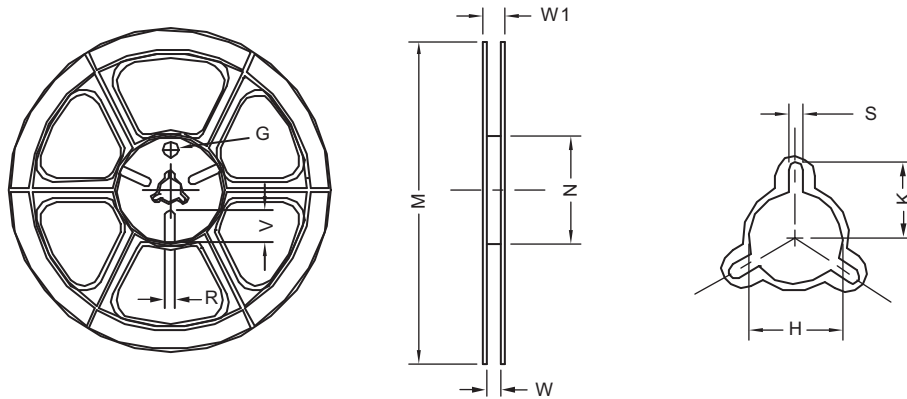

UNIT:mm

TAPE SIZE	REEL SIZE	M	N	W	W1	H	K	S	G	R	V
12 mm	φ 330	330 ± 1	62 ±1.5	12.4 +0.2	16.8 - 0.4	φ 12.75 + 0.15	---	2.0 ±0.15	---	---	---