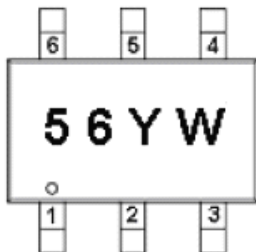
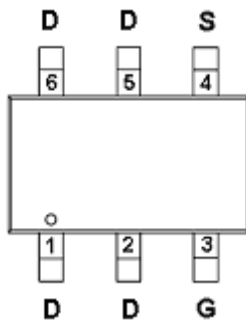

DESCRIPTION

The STN3456 is the N-Channel enhancement mode power field effect transistor which is produced using high cell density, DMOS trench technology. This high density process is especially tailored to minimize on-state resistance. These devices are particularly suited for low voltage application, such as cellular phone and notebook computer power management and other battery powered circuits, and low in-line power loss are needed in a very small outline surface mount package.

**PIN CONFIGURATION
TSOP-6P**

Y: Year Code
W: Week Code

FEATURE

- ◆ 30V/6.0A, $R_{DS(ON)}=40m\Omega@V_{GS}=10V$
- ◆ 30V/5.0A, $R_{DS(ON)}=50m\Omega@V_{GS}=4.5V$
- ◆ Super high density cell design for extremely low $R_{DS(ON)}$
- ◆ Exceptional an-resistance and maximum DC current capability
- ◆ TSOP-6P package design

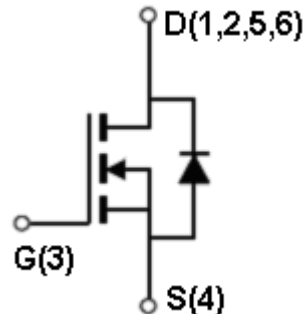
ORDERING INFORMATION

Part Number	Package	Part Marking
STN3456ST6RG	TSOP-6	56YW

※ Week Code Code : A ~ Z ; a ~ z

※ STN3456ST6RG ST6 : TSOP-6; R: Tape Reel ; G: Pb - Free



ABSOLUTE MAXIMUM RATINGS (Ta = 25°C unless otherwise noted)

Parameter	Symbol	Typical	Unit
Drain-Source Voltage	V _{DSS}	30	V
Gate-Source Voltage	V _{GSS}	±20	V
Continuous Drain Current (T _J =150°C)	I _D	T _A =25°C	6.0
		T _A =70°C	5.0
Pulsed Drain Current	I _{DM}	30	A
Continuous Source Current (Diode Conduction)	I _S	1.7	A
Power Dissipation	P _D	T _A =25°C	2.0
		T _A =70°C	1.3
Operation Junction Temperature	T _J	150	°C
Storage Temperature Range	T _{STG}	-55/150	°C
Thermal Resistance-Junction to Ambient	R _{θJA}	90	°C/W



STN3456 

N Channel Enhancement Mode MOSFET
6.0A

ELECTRICAL CHARACTERISTICS (Ta = 25°C Unless otherwise noted)

Parameter	Symbol	Condition	Min	Typ	Max	Unit
Static						
Drain-Source Breakdown Voltage	$V_{(BR)DSS}$	$V_{GS}=0V, I_D=-250\mu A$	30			V
Gate Threshold Voltage	$V_{GS(th)}$	$V_{DS}=V_{GS}, I_D=-250\mu A$	1.0		3.0	V
Gate Leakage Current	I_{GSS}	$V_{DS}=0V, V_{GS}=\pm 20V$			± 100	nA
Zero Gate Voltage Drain Current	I_{DSS}	$V_{DS}=24V, V_{GS}=1.0V$			1	uA
		$V_{DS}=24V, V_{GS}=0V$ $T_J=55^\circ C$			10	
On-State Drain Current	$I_{D(on)}$	$V_{DS}\leq -5V, V_{GS}=-10V$	10			A
Drain-source On-Resistance	$R_{DS(on)}$	$V_{GS}=10V, I_D=6.0A$		0.030	0.040	Ω
		$V_{GS}=4.5V, I_D=5.0A$		0.040	0.050	
Forward Transconductance	g_{fs}	$V_{DS}=4.5V, I_D=5.4A$		12		S
Diode Forward Voltage	V_{SD}	$I_S=1.7A, V_{GS}=0V$		0.8	1.2	V
Dynamic						
Total Gate Charge	Q_g	$V_{DS}=15V, V_{GS}=10V,$ $V_{DS}=6.7A$		10	18	nC
Gate-Source Charge	Q_{gs}			1.6		
Gate-Drain Charge	Q_{gd}			3.2		
Input Capacitance	C_{iss}	$V_{DS}=15V, V_{GS}=0,$ $f=1MHz$		450		pF
Output Capacitance	C_{oss}			240		
Reverse Transfer Capacitance	C_{rss}			38		
Turn-On Time	$T_{d(on)}$	$V_{DD}=15V,$ $R_L=15\Omega, V_{GEN}=10V$ $R_G=6\Omega$		7	15	ns
	t_r			10	20	
Turn-Off Time	$T_{d(off)}$			20	40	
	t_f			11	20	

TYPICAL CHARACTERISTICS

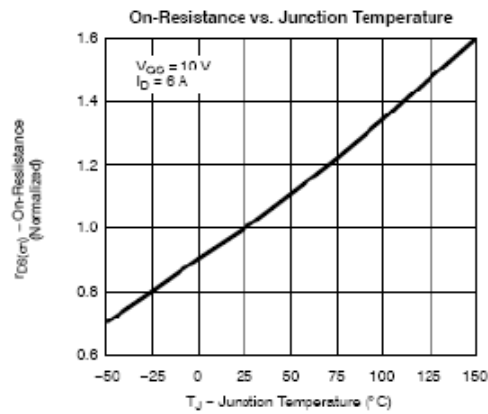
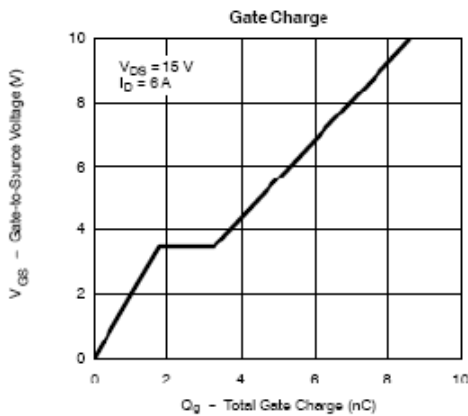
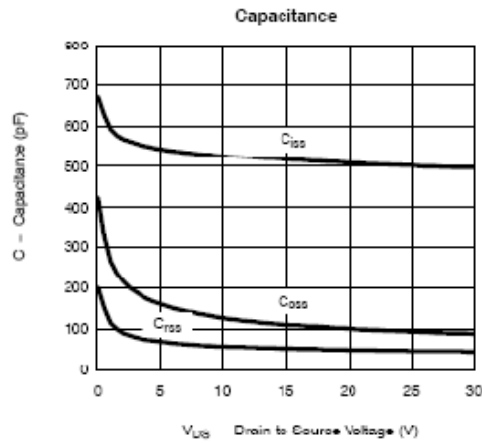
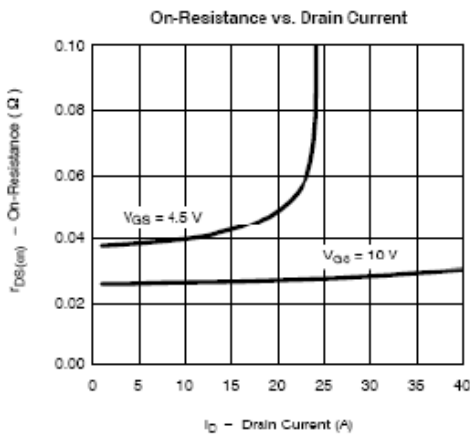
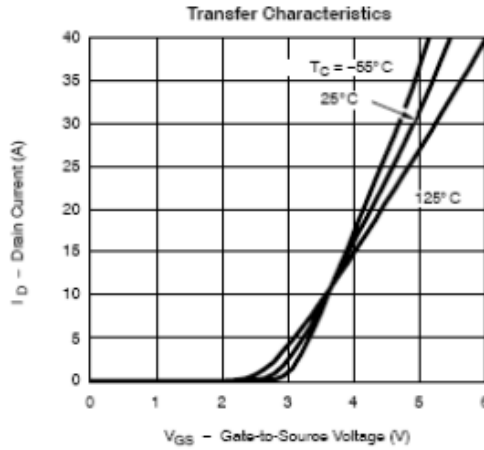
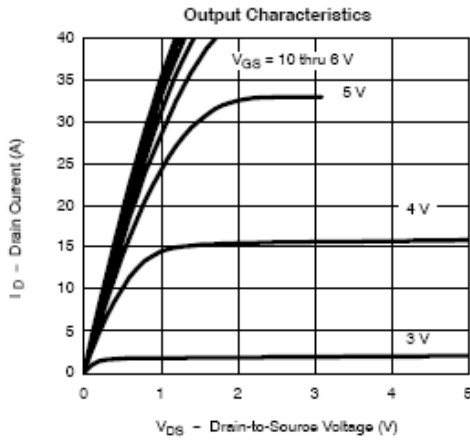

TYPICAL CHARACTERISTICS

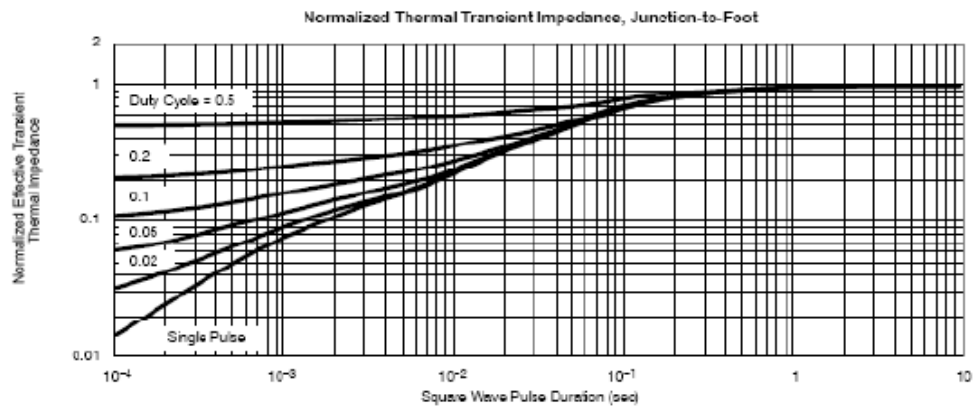
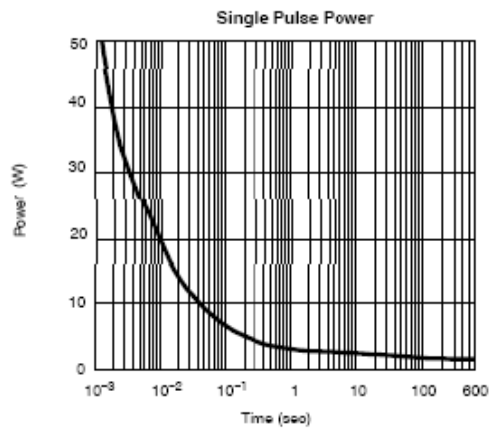
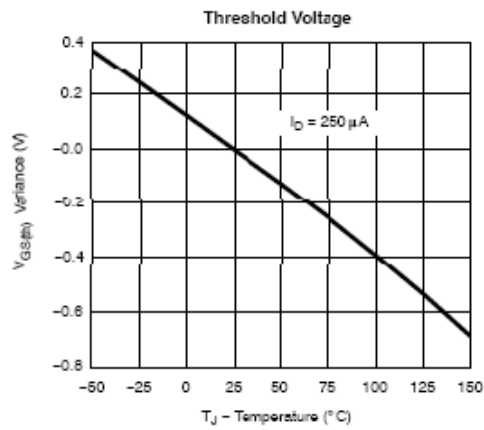
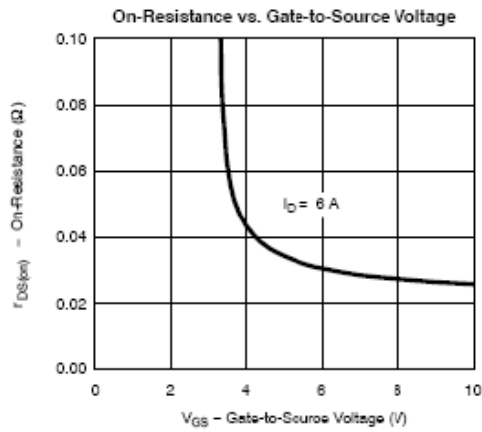
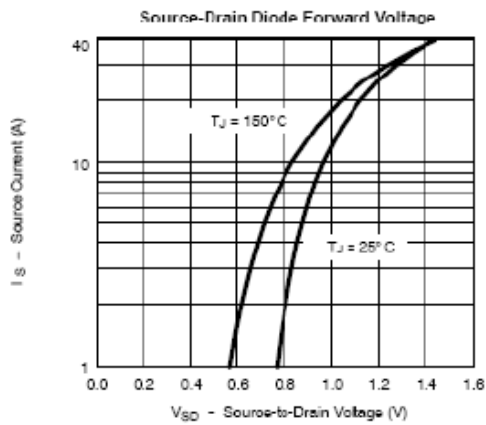

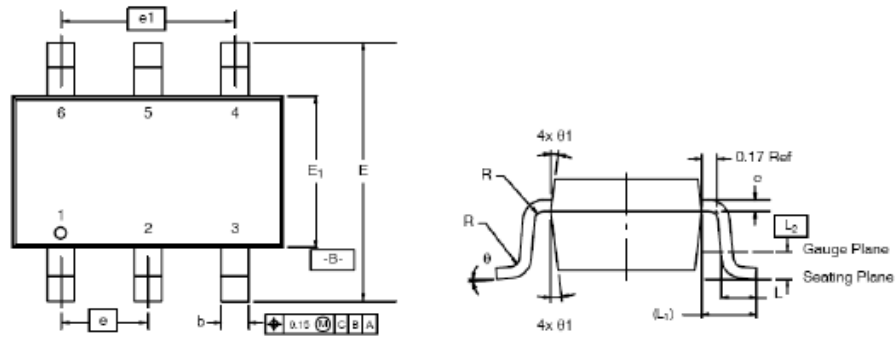
TSOP-6 PACKAGE OUTLINE

Dim	MILLIMETERS			INCHES		
	Min	Nom	Max	Min	Nom	Max
A	0.91	-	1.10	0.036	-	0.043
A ₁	0.01	-	0.10	0.0004	-	0.004
A ₂	0.90	-	1.00	0.035	0.038	0.039
b	0.30	0.32	0.45	0.012	0.013	0.018
c	0.10	0.15	0.20	0.004	0.006	0.008
D	2.95	3.05	3.10	0.116	0.120	0.122
E	2.70	2.85	2.98	0.106	0.112	0.117
E ₁	1.55	1.65	1.70	0.061	0.065	0.067
e	1.00 BSC			0.0394 BSC		
e ₁	1.90	2.00	2.10	0.075	0.080	0.085
L	0.35	-	0.50	0.014	-	0.020
L ₁	0.60 Ref			0.024 Ref		
L ₂	0.25 BSC			0.010 BSC		
R	0.10	-	-	0.004	-	-
θ	0°	4°	8°	0°	4°	8°
θ ₁	7° Nom			7° Nom		