



N-Channel Enhancement Mode Field Effect Transistor

PRODUCT SUMMARY

V _{DSS}	I _D	R _{DS(ON)} (Ω) Typ
200V	5A	1.1 @ V _{GS} =10V
		1.3 @ V _{GS} =4.5V

FEATURES

- Super high dense cell design for low R_{DS(ON)}.
- Rugged and reliable.
- TO-220 and TO-220F Package.

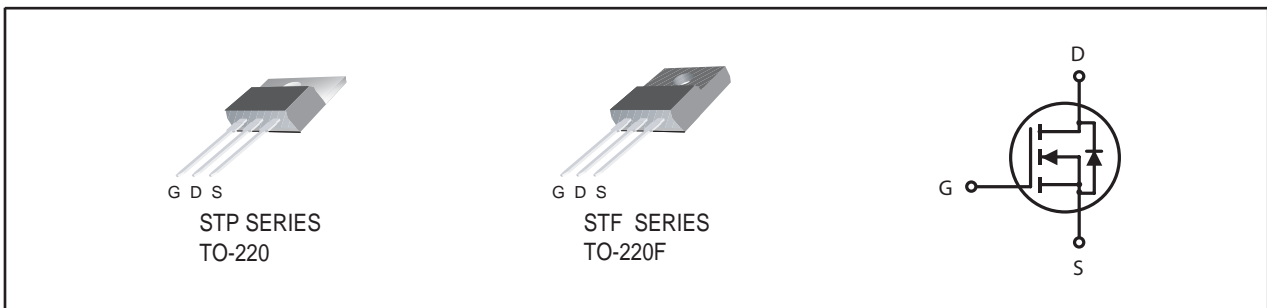

ABSOLUTE MAXIMUM RATINGS (T_C=25°C unless otherwise noted)

Symbol	Parameter	STP06N20	STF06N20	Units	
V _{DS}	Drain-Source Voltage	200		V	
V _{GS}	Gate-Source Voltage	±20	±20	V	
I _D	Drain Current-Continuous ^a	T _C =25°C	5	5	A
		T _C =100°C	3.5	3.5	A
I _{DM}	-Pulsed ^a	15	15	A	
P _D	Maximum Power Dissipation	T _C =25°C	75	25	W
		T _C =100°C	37.5	12.5	W
T _J , T _{STG}	Operating Junction and Storage Temperature Range	-55 to 175		°C	

THERMAL CHARACTERISTICS

R _{θJC}	Thermal Resistance, Junction-to-Case	2	6	°C/W
R _{θJA}	Thermal Resistance, Junction-to-Ambient	62.5	62.5	°C/W

STP06N20

STF06N20

Ver 1.0

ELECTRICAL CHARACTERISTICS (T_C=25°C unless otherwise noted)

Symbol	Parameter	Conditions	Min	Typ	Max	Units
OFF CHARACTERISTICS						
BV _{DSS}	Drain-Source Breakdown Voltage	V _{GS} =0V, I _D =10mA	200			V
I _{DSS}	Zero Gate Voltage Drain Current	V _{DS} =160V, V _{GS} =0V			1	μA
I _{GSS}	Gate-Body Leakage Current	V _{GS} = ±20V, V _{DS} =0V			±100	nA
ON CHARACTERISTICS						
V _{GS(th)}	Gate Threshold Voltage	V _{DS} =V _{GS} , I _D =250μA	1	1.6	3	V
R _{DS(ON)}	Drain-Source On-State Resistance	V _{GS} =10V, I _D =2.5A		1.1	1.5	ohm
R _{DS(ON)}	Drain-Source On-State Resistance	V _{GS} =4.5V, I _D =2.5A		1.3	1.75	ohm
g _{FS}	Forward Transconductance	V _{DS} =10V, I _D =2.5A		4		S
DYNAMIC CHARACTERISTICS ^b						
C _{ISS}	Input Capacitance	V _{DS} =25V, V _{GS} =0V f=1.0MHz		423		pF
C _{OSS}	Output Capacitance			24		pF
C _{RSS}	Reverse Transfer Capacitance			16		pF
SWITCHING CHARACTERISTICS ^b						
t _{D(ON)}	Turn-On Delay Time	V _{DD} =100V I _D =1A V _{GS} =10V R _{GEN} = 6 ohm		9.6		ns
t _r	Rise Time			8.7		ns
t _{D(OFF)}	Turn-Off Delay Time			22.2		ns
t _f	Fall Time			4.9		ns
Q _g	Total Gate Charge	V _{DS} =100V, I _D =1A, V _{GS} =10V		7.2		nC
		V _{DS} =100V, I _D =1A, V _{GS} =4.5V		4		nC
Q _{gs}	Gate-Source Charge	V _{DS} =100V, I _D =1A, V _{GS} =10V		0.94		nC
Q _{gd}	Gate-Drain Charge			2		nC
DRAIN-SOURCE DIODE CHARACTERISTICS AND MAXIMUM RATINGS						
V _{SD}	Diode Forward Voltage	V _{GS} =0V, I _S =1A		0.83	1.4	V

Notes

- a. Drain current limited by maximum junction temperature.
b. Guaranteed by design, not subject to production testing.

Oct,28,2013

STP06N20

STF06N20

Ver 1.0

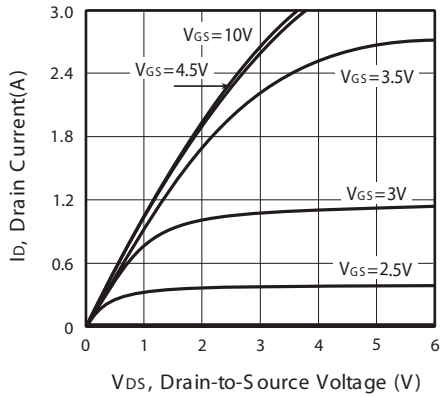

Figure 1. Output C characteristics

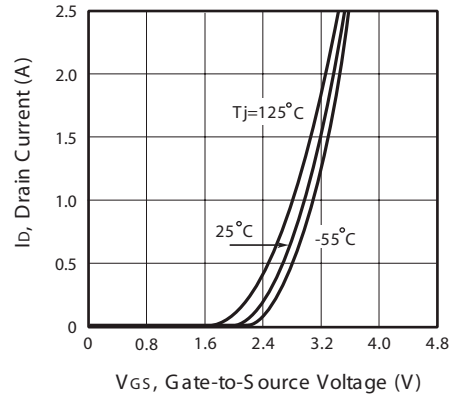

Figure 2. Transfer C characteristics

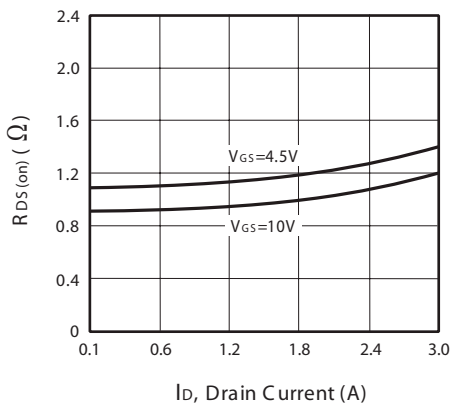

Figure 3. On-Resistance vs. Drain Current and Gate Voltage

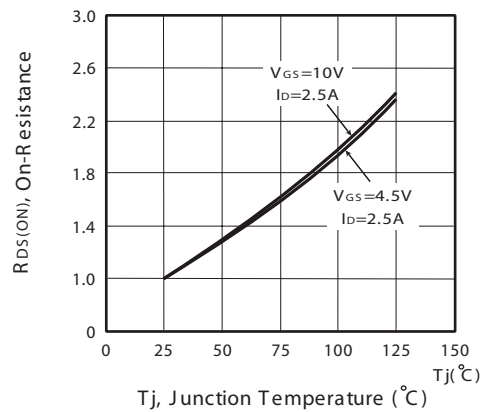

Figure 4. On-R resistance Variation with Drain Current and Temperature

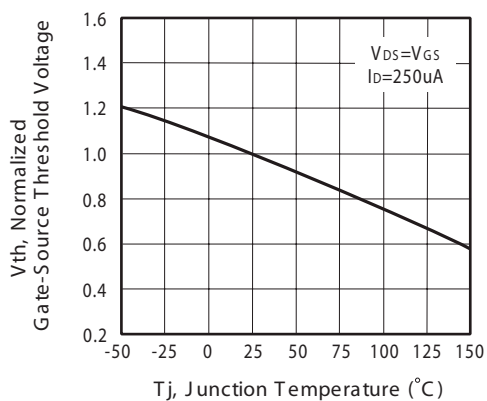

Figure 5. Gate Threshold Variation with Temperature

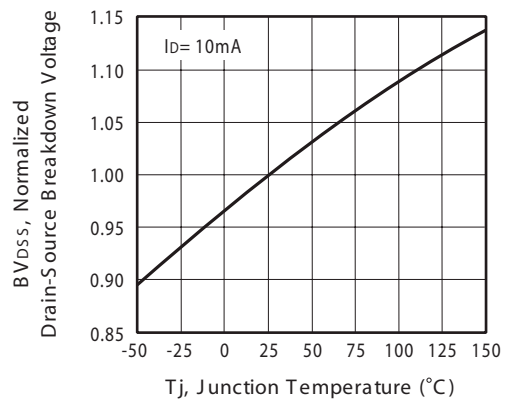

Figure 6. Breakdown Voltage Variation with Temperature

Oct,28,2013

STP06N20

STF06N20

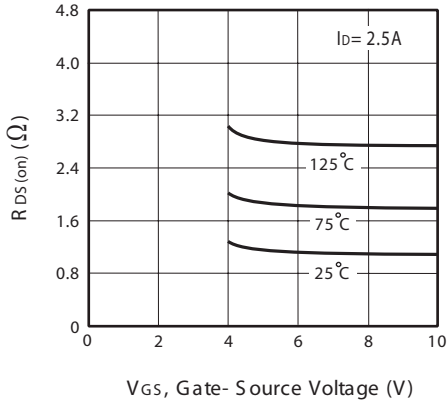

Figure 7. On-Resistance vs. Gate-Source Voltage

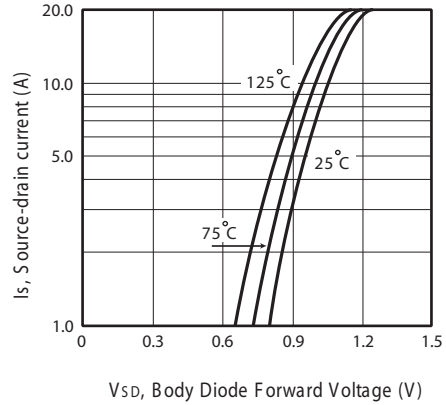

Figure 8. Body Diode Forward Voltage Variation with Source Current

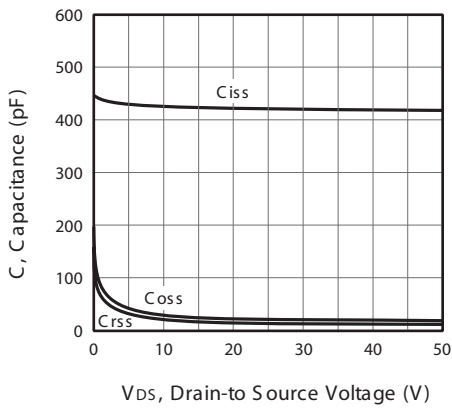

Figure 9. Capacitance

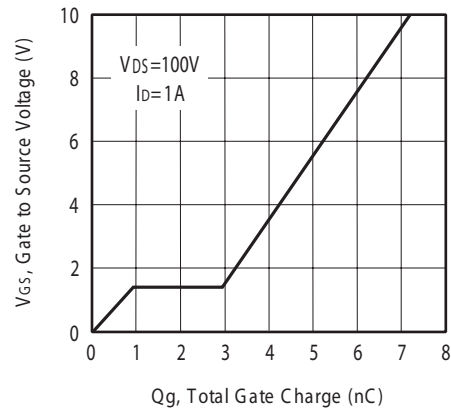

Figure 10. Gate Charge

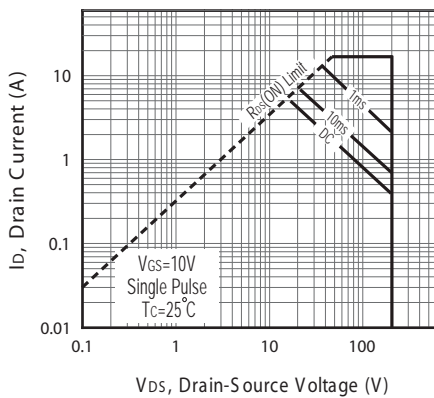

Figure 11a. Maximum Safe Operating Area for STP06N20

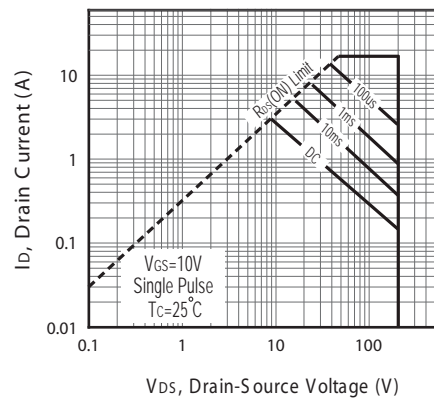

Figure 11b. Maximum Safe Operating Area for STF06N20

STP06N20

STF06N20

Ver 1.0

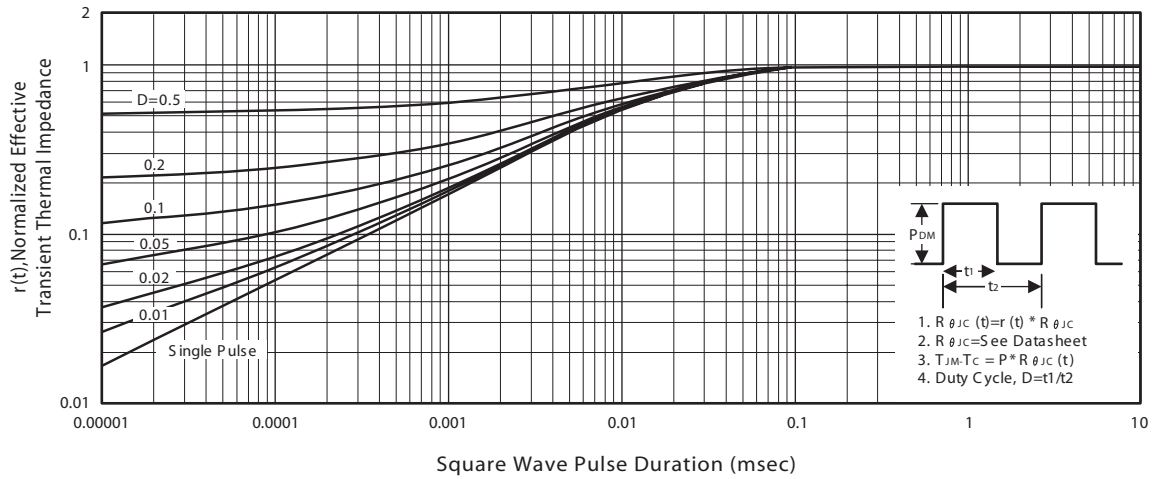

Figure 12a. Normalized Thermal Transient Impedance Curve for STP06N20

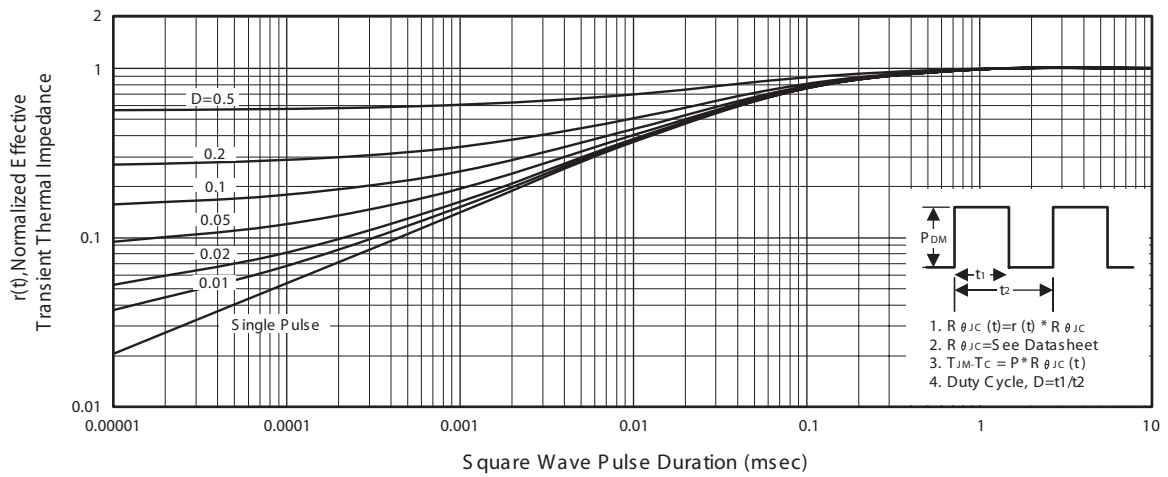

Figure 12b. Normalized Thermal Transient Impedance Curve for STF06N20

Oct,28,2013

STP06N20

STF06N20

Ver 1.0

PACKAGE OUTLINE DIMENSIONS

TO-220

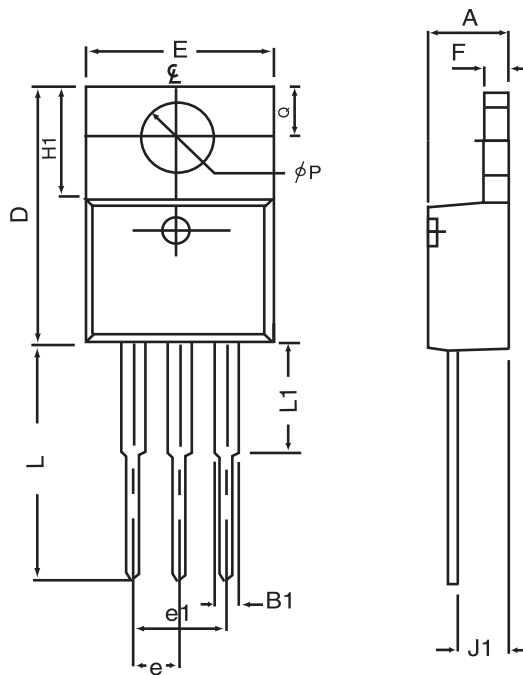

SYMBOLS	MILLIMETERS		INCHES	
	MIN	MAX	MIN	MAX
A	4.32	4.80	0.170	0.189
B1	1.27	1.65	0.050	0.630
D	14.6	16.00	0.575	0.610
E	9.70	10.41	0.382	0.410
e	2.34	2.74	0.092	0.108
e1	4.68	5.48	0.184	0.216
F	1.14	1.40	0.045	0.055
H1	5.97	6.73	0.235	0.265
J1	2.20	2.79	0.087	0.110
L	12.88	14.22	0.507	0.560
L1	3.00	6.35	0.120	0.250
phi P	3.50	3.94	0.138	0.155
Q	2.54	3.05	0.100	0.120

Oct,28,2013

STP06N20

STF06N20

Ver 1.0

PACKAGE OUTLINE DIMENSIONS

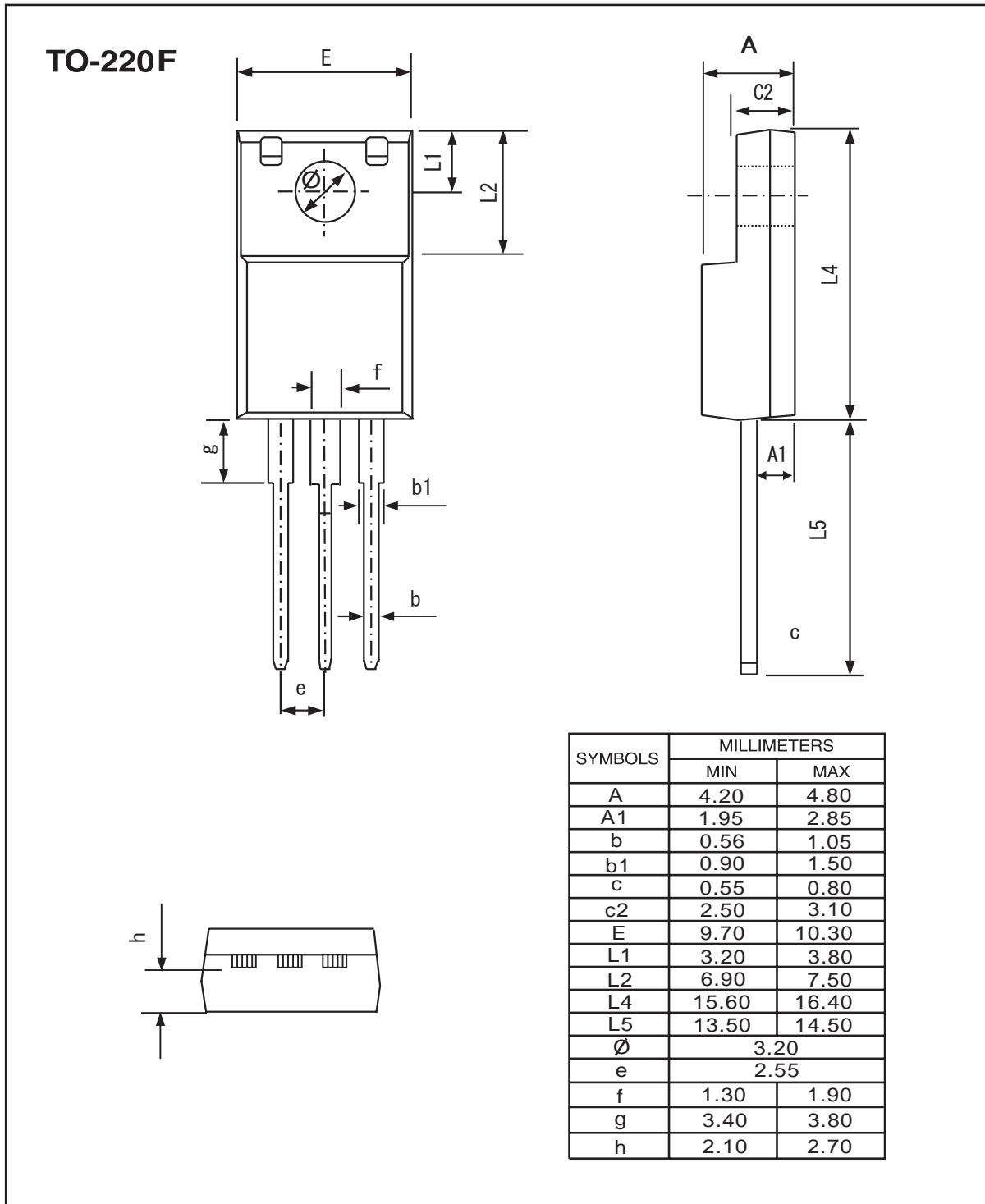

Oct,28,2013

STP06N20

STF06N20

Ver 1.0

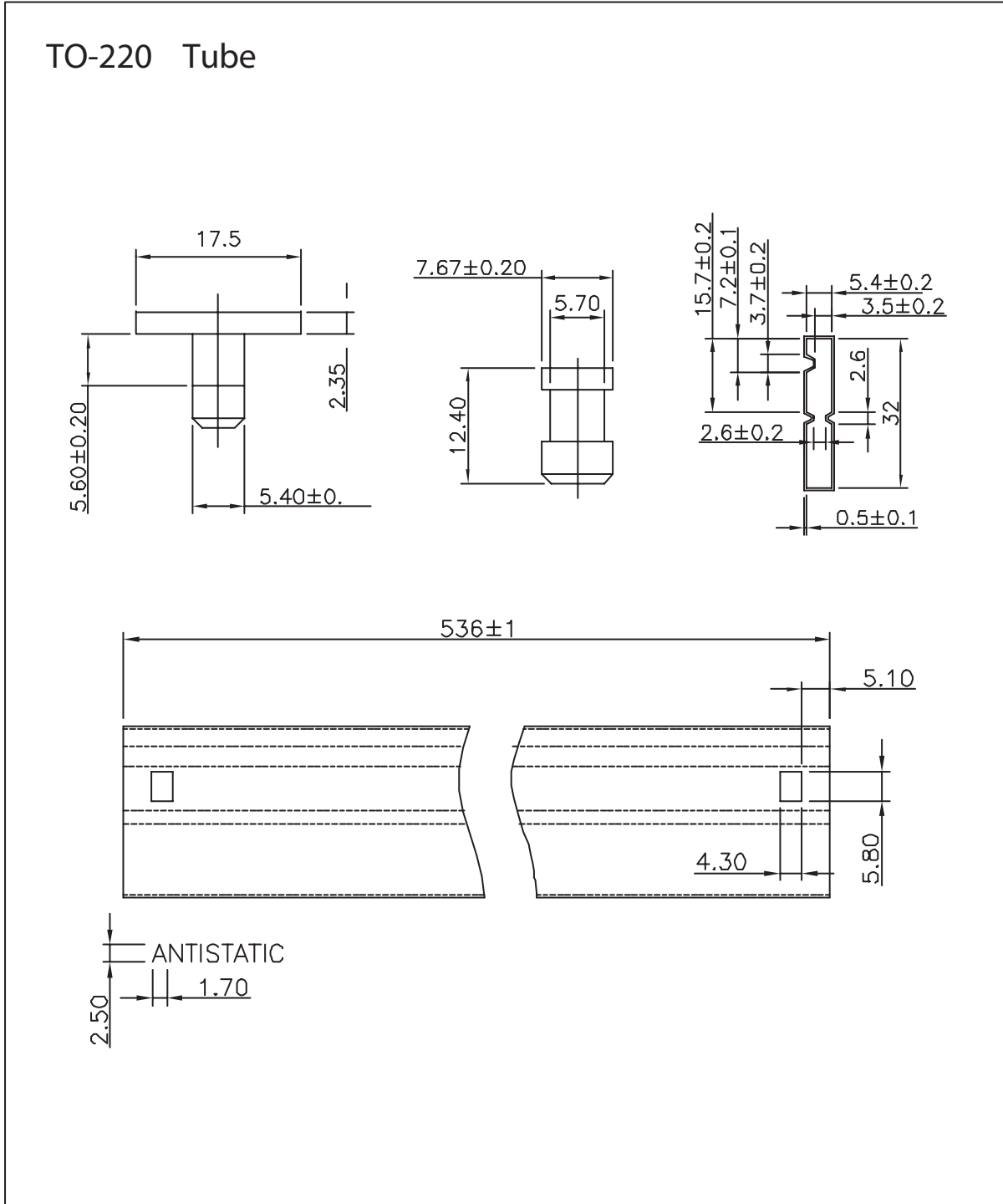

Oct,28,2013

STP06N20

STF06N20

Ver 1.0

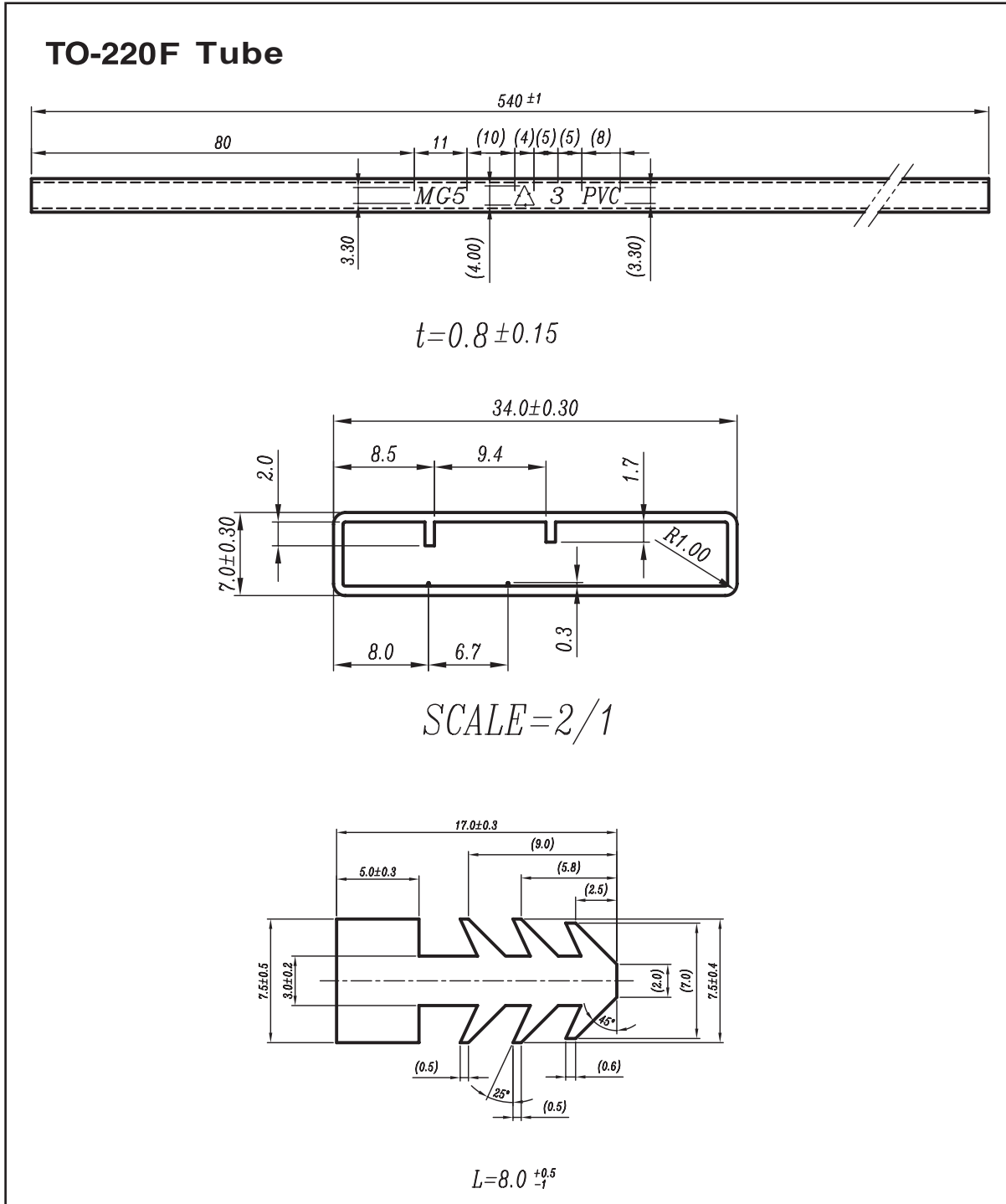

Oct, 28, 2013

STP06N20

STF06N20

Ver 1.0

TOP MARKING DEFINITION

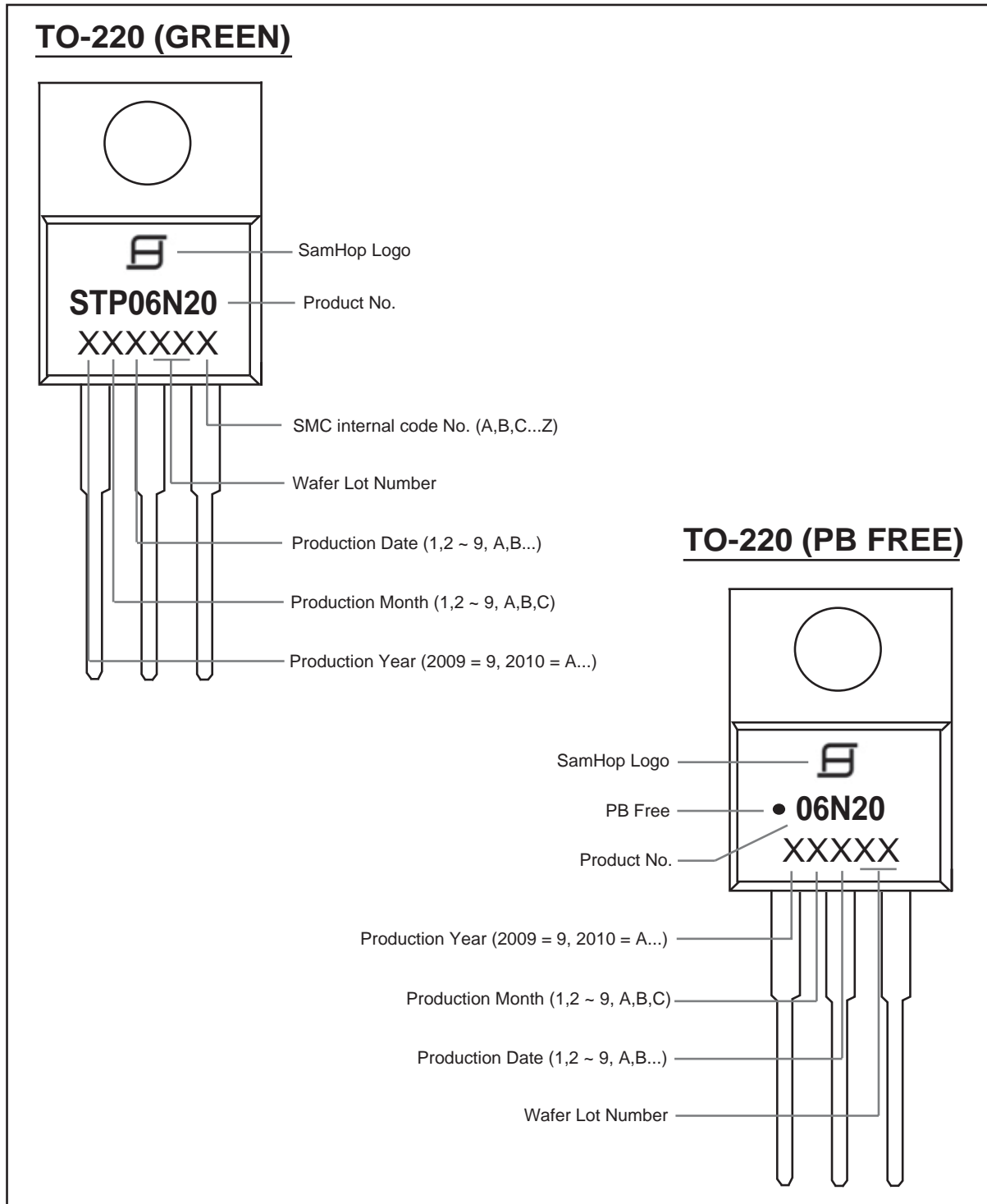

Oct,28,2013

STP06N20

STF06N20

Ver 1.0

TOP MARKING DEFINITION

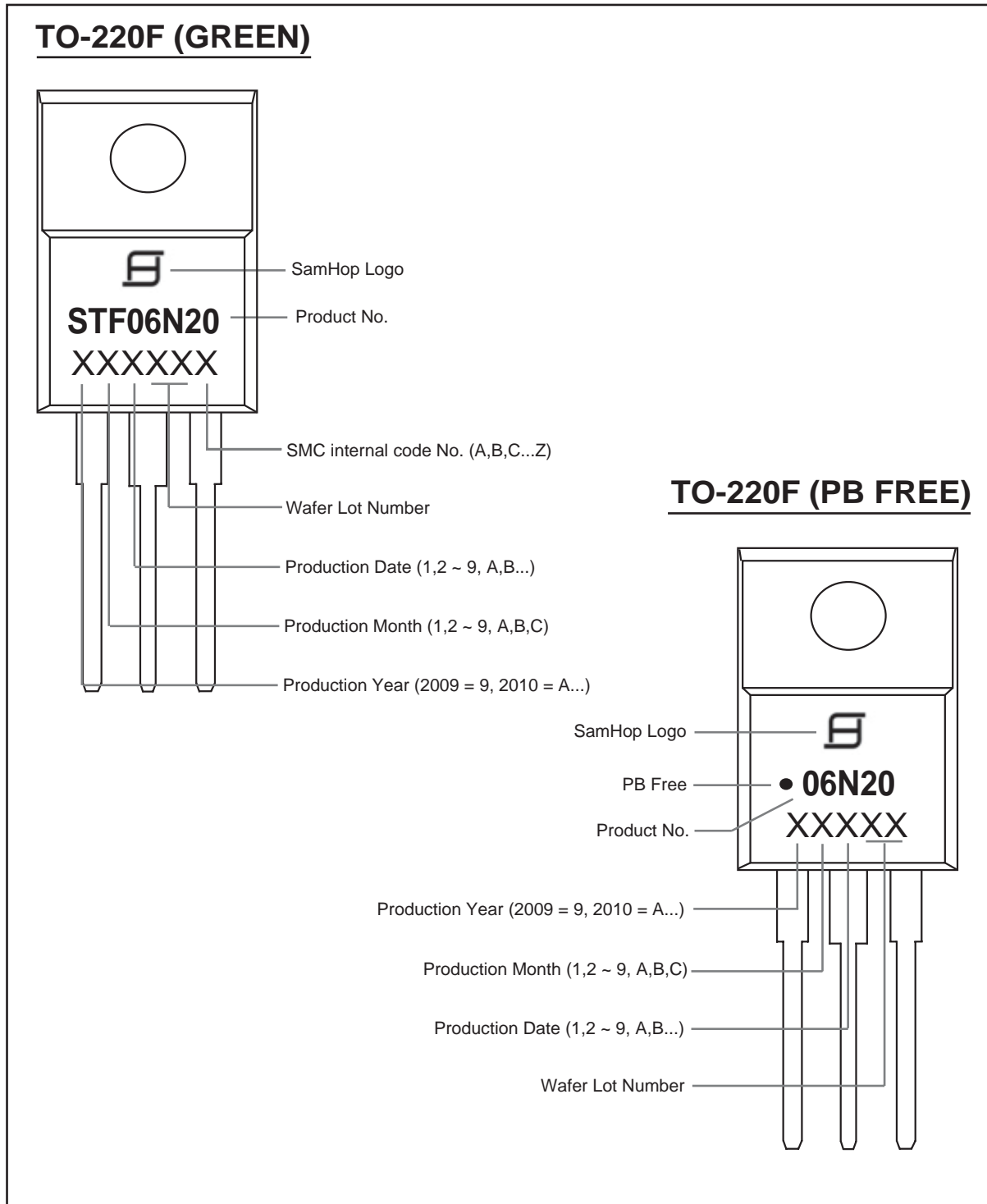

Oct,28,2013