



N-Channel Enhancement Mode Field Effect Transistor

PRODUCT SUMMARY		
V _{DS}	I _D	R _{DS(ON)} (mΩ) Typ
100V	15A	110 @ V _{GS} =10V
		121 @ V _{GS} =4.5V

FEATURES

- Super high dense cell design for low R_{DS(ON)}.
- Rugged and reliable.
- TO-220 and TO-220F Package.

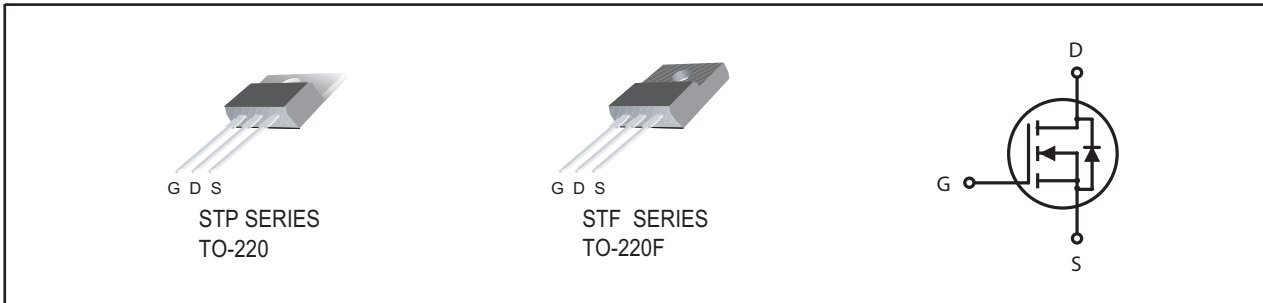

ABSOLUTE MAXIMUM RATINGS (T_C=25°C unless otherwise noted)

Symbol	Parameter	TO-220	TO-220F	Units	
V _{DS}	Drain-Source Voltage	100		V	
V _{GS}	Gate-Source Voltage	±20	±20	V	
I _D	Drain Current-Continuous ^a	T _C =25°C	15	15 ^e	A
		T _C =70°C	12.6	12.6 ^e	A
I _{DM}	-Pulsed ^b	45	45 ^e	A	
E _{AS}	Single Pulse Avalanche Energy ^d	25		mJ	
P _D	Maximum Power Dissipation ^a	T _C =25°C	58	25	W
		T _C =70°C	40	17.5	W
T _J , T _{STG}	Operating Junction and Storage Temperature Range	-55 to 175		°C	

THERMAL CHARACTERISTICS

Symbol	Parameter	TO-220	TO-220F	Units
R _{θJC}	Thermal Resistance, Junction-to-Case ^a	2.6	6	°C/W
R _{θJA}	Thermal Resistance, Junction-to-Ambient ^a	62.5	62.5	°C/W

STP15L01/F

Ver1.0

ELECTRICAL CHARACTERISTICS (T_A=25°C unless otherwise noted)

Symbol	Parameter	Conditions	Min	Typ	Max	Units
OFF CHARACTERISTICS						
BV _{DSS}	Drain-Source Breakdown Voltage	V _{GS} =0V , I _D =250uA	100			V
I _{DSS}	Zero Gate Voltage Drain Current	V _{DS} =80V , V _{GS} =0V			1	uA
I _{GSS}	Gate-Body Leakage Current	V _{GS} = ±20V , V _{DS} =0V			±100	nA
ON CHARACTERISTICS						
V _{GS(th)}	Gate Threshold Voltage	V _{DS} =V _{GS} , I _D =250uA	1	1.7	3	V
R _{DS(ON)}	Drain-Source On-State Resistance	V _{GS} =10V , I _D =7A		110	138	m-ohm
		V _{GS} =4.5V , I _D =6A		121	163	m-ohm
g _{FS}	Forward Transconductance	V _{DS} =20V , I _D =7A		15		S
DYNAMIC CHARACTERISTICS [°]						
C _{ISS}	Input Capacitance	V _{DS} =25V, V _{GS} =0V f=1.0MHz		675		pF
C _{OSS}	Output Capacitance			48		pF
C _{RSS}	Reverse Transfer Capacitance			32		pF
SWITCHING CHARACTERISTICS [°]						
t _{D(ON)}	Turn-On Delay Time	V _{DD} =50V I _D =1A V _{GS} =10V R _{GEN} = 6 ohm		16		ns
t _r	Rise Time			14.5		ns
t _{D(OFF)}	Turn-Off Delay Time			31		ns
t _f	Fall Time			6.4		ns
Q _g	Total Gate Charge	V _{DS} =50V, I _D =7A, V _{GS} =10V		12.4		nC
		V _{DS} =50V, I _D =7A, V _{GS} =4.5V		6.4		nC
Q _{gs}	Gate-Source Charge	V _{DS} =50V, I _D =7A, V _{GS} =10V		1.7		nC
Q _{gd}	Gate-Drain Charge			3.5		nC
DRAIN-SOURCE DIODE CHARACTERISTICS AND MAXIMUM RATINGS						
V _{SD}	Diode Forward Voltage	V _{GS} =0V, I _S =2A		0.8	1.3	V

Notes

- Surface Mounted on FR4 Board, t ≤ 10sec.
- Pulse Test: Pulse Width ≤ 300us, Duty Cycle ≤ 2%.
- Guaranteed by design, not subject to production testing.
- Starting T_J=25°C, L=0.5mH, V_{DD} = 50V. (See Figure12)
- Drain current limited by maximum junction temperature.

Nov,01,2010

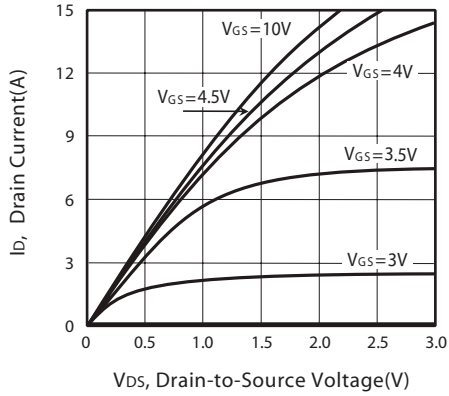

Figure 1. Output Characteristics

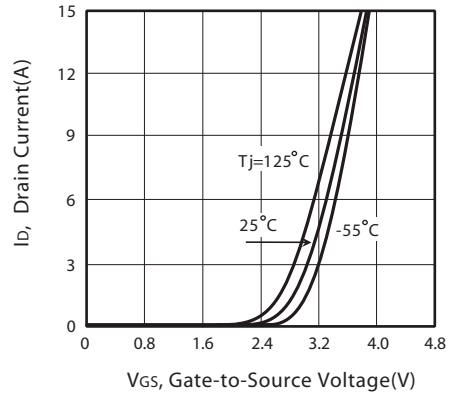

Figure 2. Transfer Characteristics

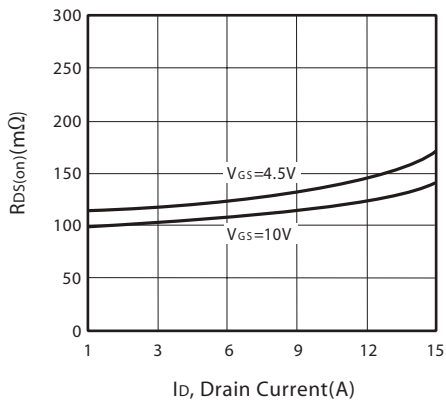

Figure 3. On-Resistance vs. Drain Current and Gate Voltage

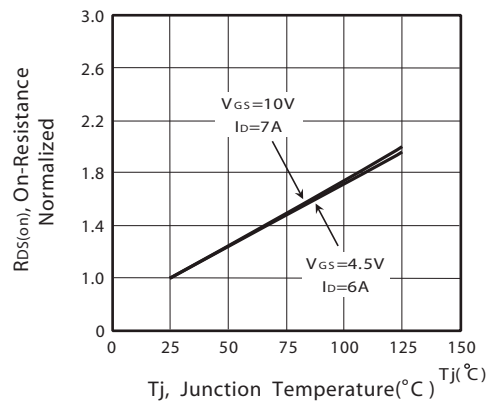

Figure 4. On-Resistance Variation with Drain Current and Temperature

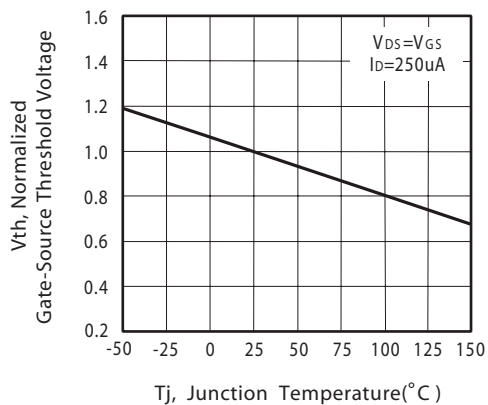

Figure 5. Gate Threshold Variation with Temperature

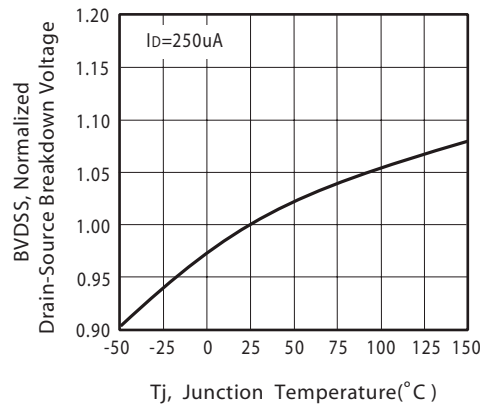

Figure 6. Breakdown Voltage Variation with Temperature

STP15L01/F

Ver 1.0

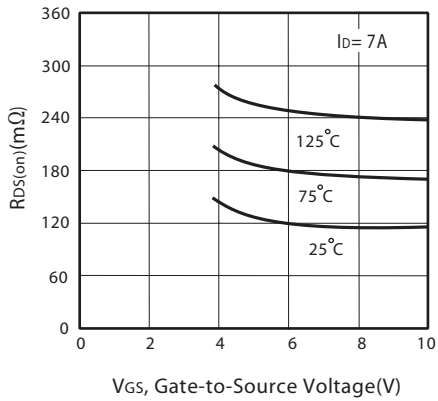

Figure 7. On-Resistance vs. Gate-Source Voltage

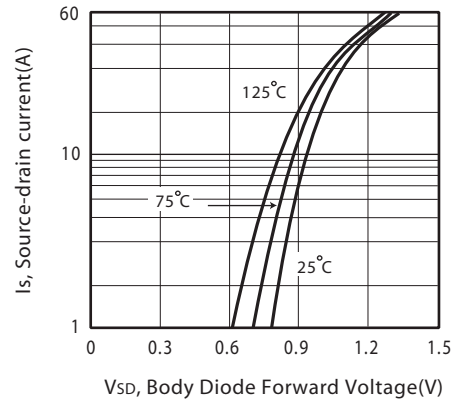

Figure 8. Body Diode Forward Voltage Variation with Source Current

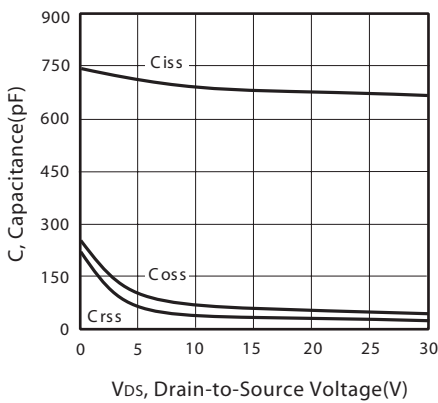

Figure 9. Capacitance

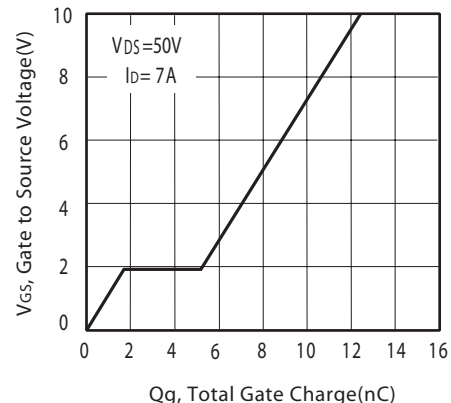

Figure 10. Gate Charge

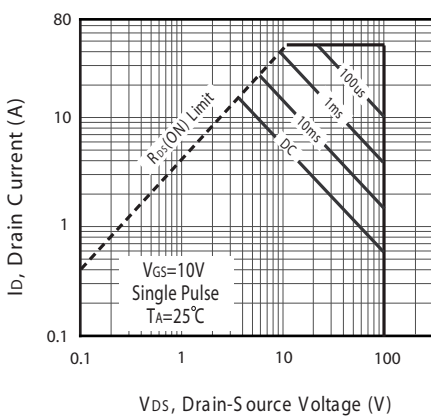

Figure 11a. Maximum Safe Operating Area for STP15L01

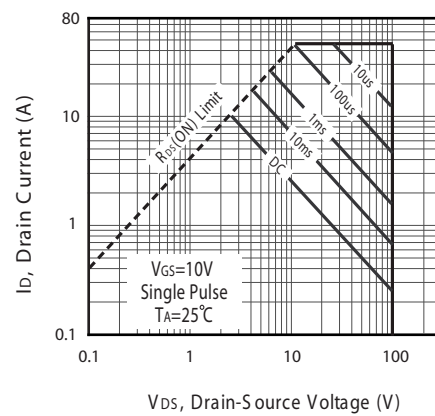
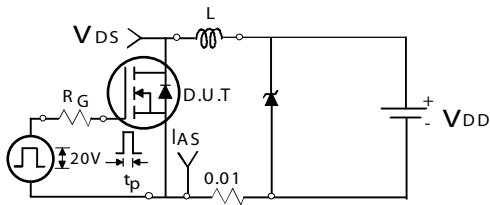

Figure 11b. Maximum Safe Operating Area for STP15L01F

Nov,01,2010

STP15L01/F

Ver 1.0



Unclamped Inductive Test Circuit

Figure 12a.

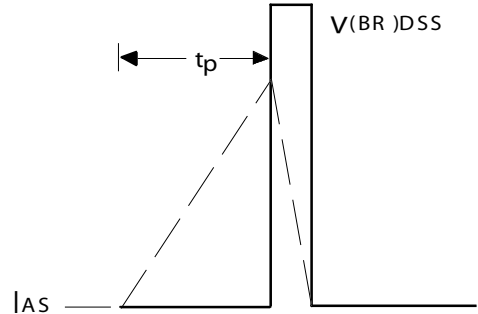

Unclamped Inductive Waveforms

Figure 12b.

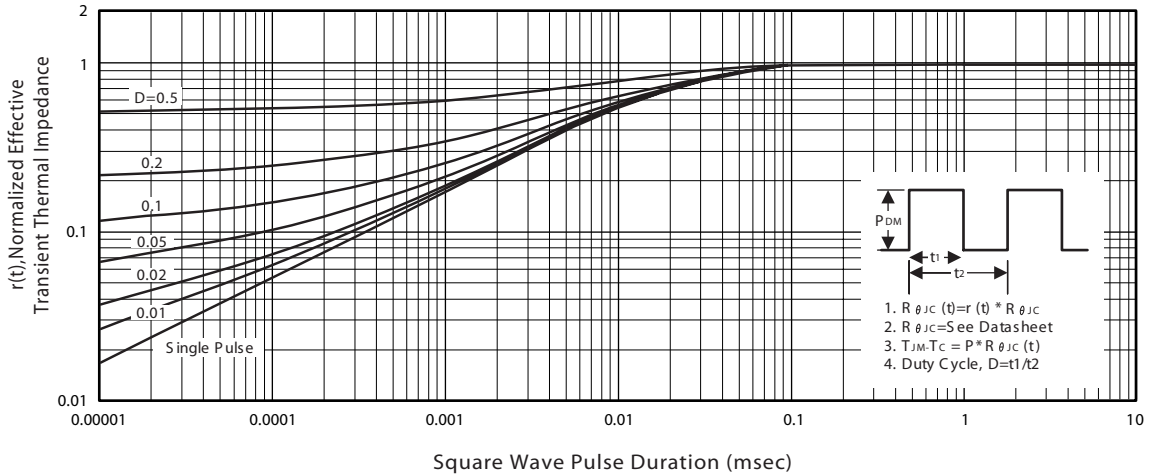

Figure 13a. Normalized Thermal Transient Impedance Curve for STP15L01

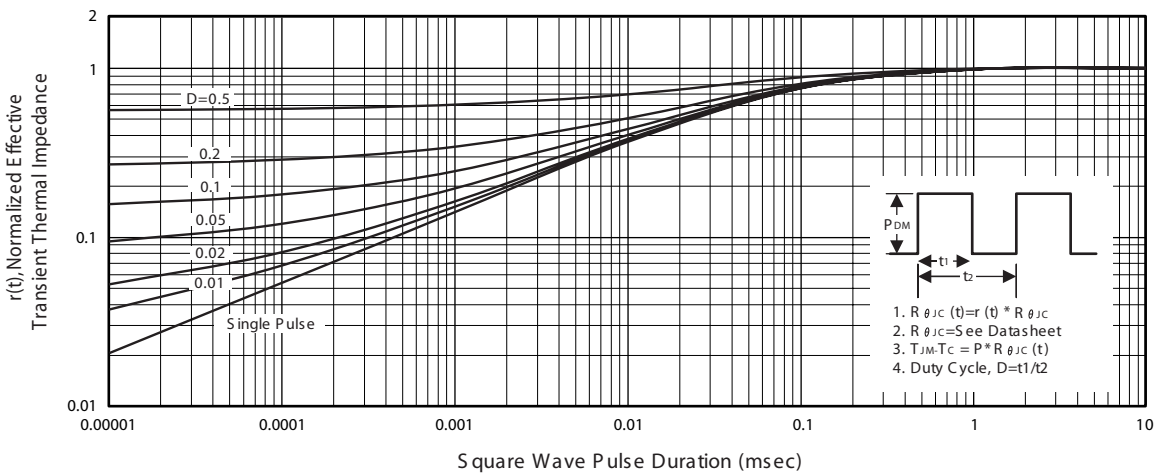

Figure 13b. Normalized Thermal Transient Impedance Curve for STP15L01F

Nov,01,2010

STP15L01/F

Ver 1.0

PACKAGE OUTLINE DIMENSIONS

TO-220

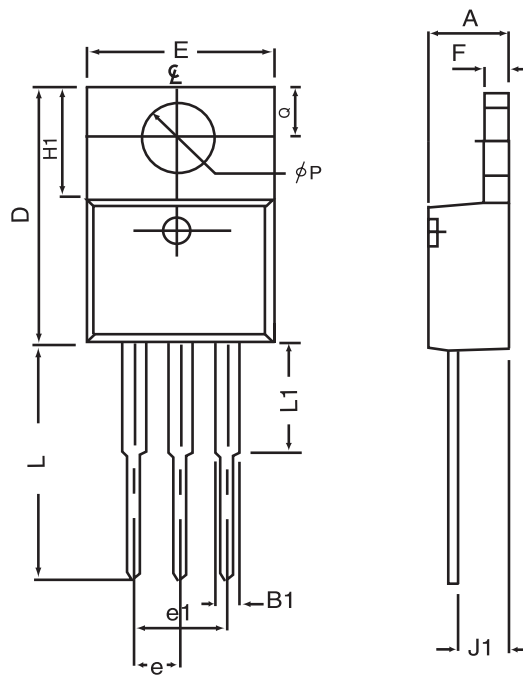

SYMBOLS	MILLIMETERS		INCHES	
	MIN	MAX	MIN	MAX
A	4.32	4.80	0.170	0.189
B1	1.27	1.65	0.050	0.630
D	14.6	16.00	0.575	0.610
E	9.70	10.41	0.382	0.410
e	2.34	2.74	0.092	0.108
e1	4.68	5.48	0.184	0.216
F	1.14	1.40	0.045	0.055
H1	5.97	6.73	0.235	0.265
J1	2.20	2.79	0.087	0.110
L	12.88	14.22	0.507	0.560
L1	3.00	6.35	0.120	0.250
φP	3.50	3.94	0.138	0.155
Q	2.54	3.05	0.100	0.120

Nov,01,2010

STP15L01/F

Ver 1.0

PACKAGE OUTLINE DIMENSIONS

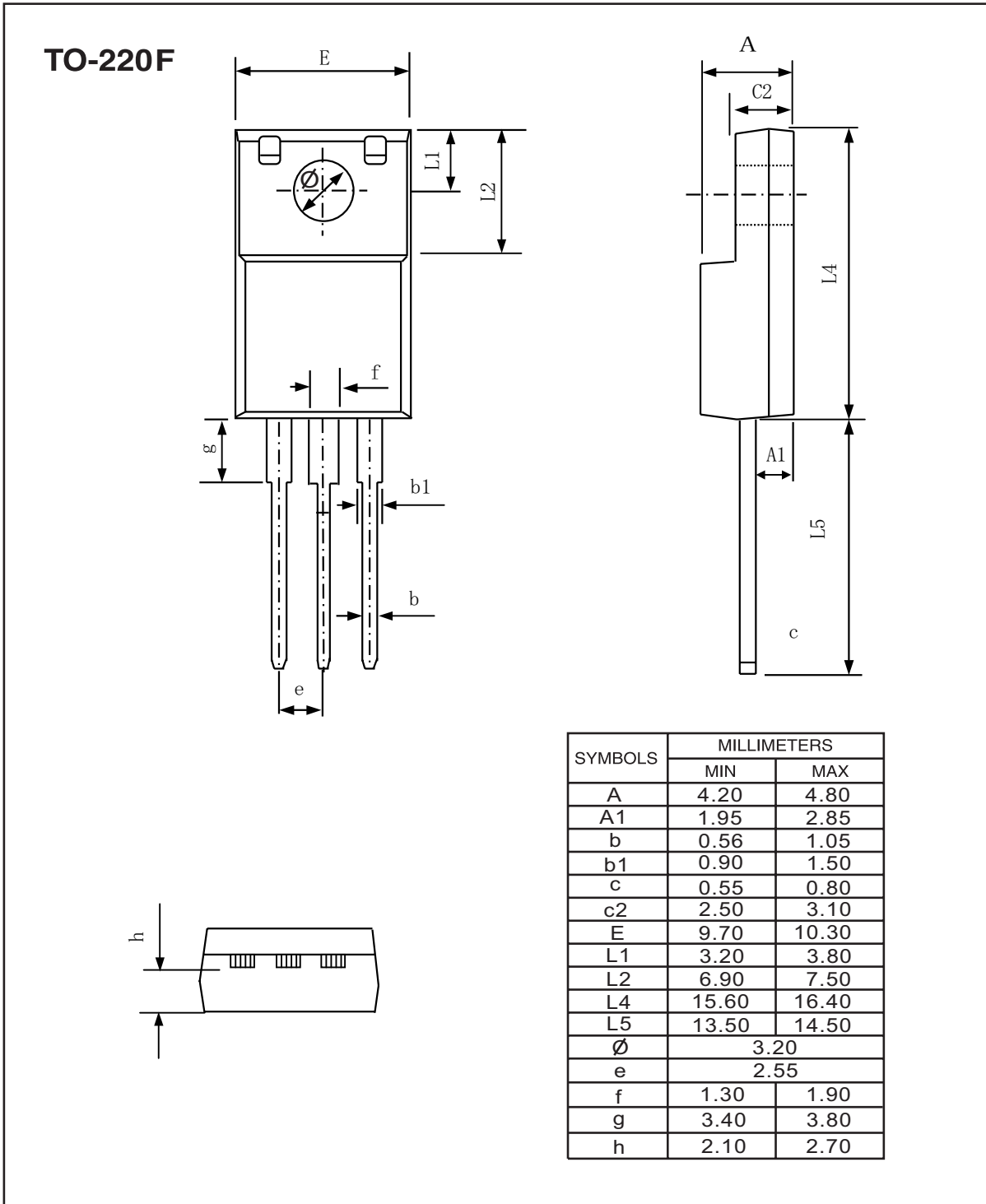

Nov,01,2010

STP15L01/F

Ver 1.0

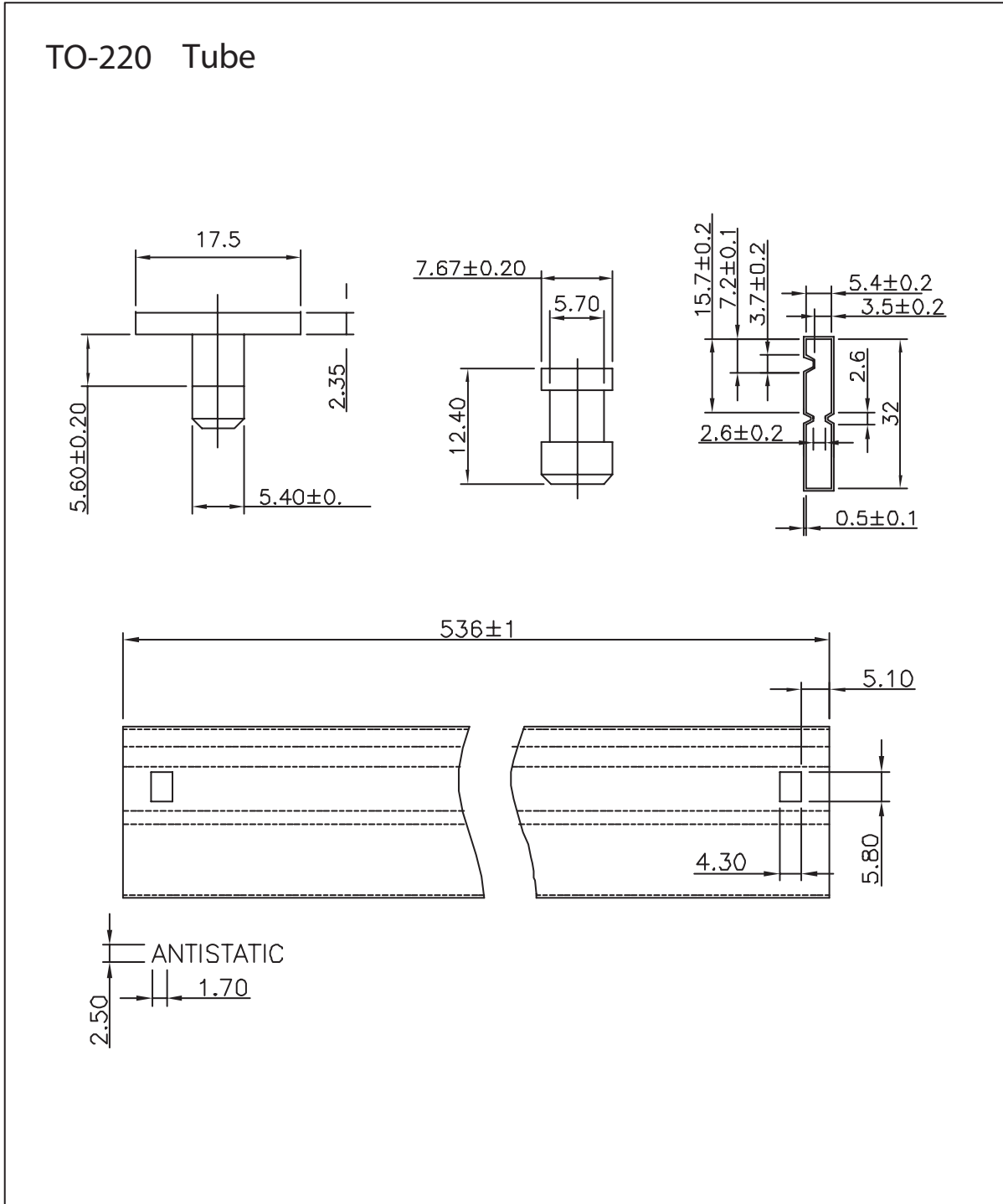

Nov,01,2010

STP15L01/F

Ver 1.0

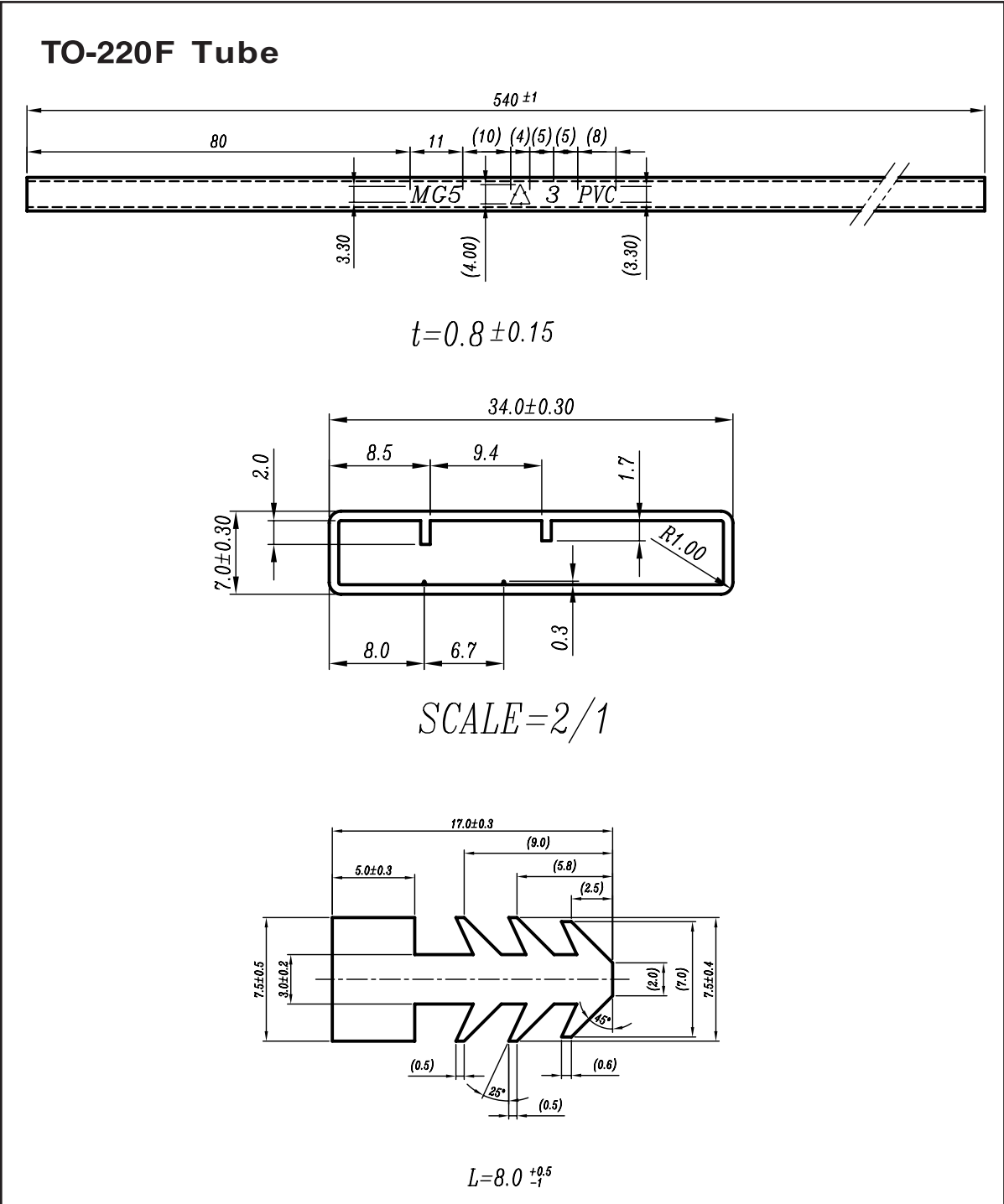

Nov,01,2010