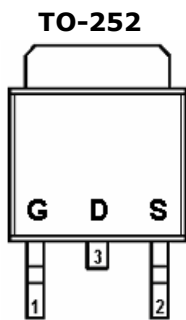
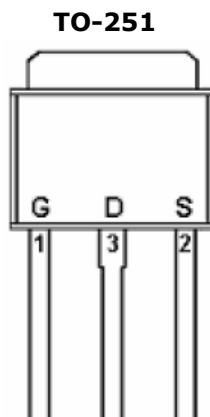


DESCRIPTION

STP601/STP601D is the P-Channel logic enhancement mode power field effect transistor which is produced using high cell density, DMOS trench technology. The STP601 has been designed specially to improve the overall efficiency of DC/DC converters using either synchronous or conventional switching PWM controllers. It has been optimized for low gate charge, low $R_{DS(ON)}$ and fast switching speed.

PIN CONFIGURATION (D-PAK)


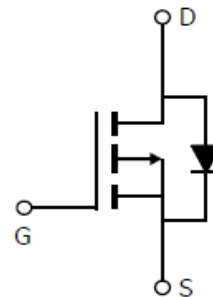
(STP601D)



(STP610)

FEATURE

- -60V/-20.0A, $R_{DS(ON)} = 20m\Omega$ (typ.) @ $V_{GS} = -10V$
- -60V/-20.0A, $R_{DS(ON)} = 27m\Omega$ @ $V_{GS} = -4.5V$
- Super high density cell design for extremely low $R_{DS(ON)}$
- Exceptional on-resistance and maximum DC current capability
- TO-252,TO-251 package design

PART MARKING


Y: Year Code
A: Week Code
Q: Process Code



STP601 / STP601D

P Channel Enhancement Mode MOSFET



-30A

ABSOLUTE MAXIMUM RATINGS (Ta = 25°C Unless otherwise noted)

Parameter	Symbol	Typical	Unit
Drain-Source Voltage	VDSS	-60	V
Gate-Source Voltage	VGSS	±20	V
Continuous Drain Current (TJ=150°C)	ID	TA=25°C -30.0	A
		TA=100°C -22.0	
Pulsed Drain Current	IDM	-110	A
Continuous Source Current (Diode Conduction)	IS	-30	A
Power Dissipation	PD	TA=25°C 60	W
Operation Junction Temperature		TJ	
Storage Temperature Range	TSTG	-55/150	°C
Thermal Resistance-Junction to Ambient	RθJA	25	°C/W



STP601 / STP601D

P Channel Enhancement Mode MOSFET



-30A

ELECTRICAL CHARACTERISTICS (Ta = 25°C Unless otherwise noted)

Parameter	Symbol	Condition	Min	Typ	Max	Unit
Static						
Drain-Source Breakdown Voltage	$V_{(BR)DSS}$	$V_{GS}=0V, I_D=-250\mu A$	-60			V
Gate Threshold Voltage	$V_{GS(th)}$	$V_{DS}=V_{GS}, I_D=-250\mu A$	-1.0		-3.0	V
Gate Leakage Current	I_{GSS}	$V_{DS}=0V, V_{GS}=\pm 20V$			± 100	nA
Zero Gate Voltage Drain Current	I_{DSS}	$V_{DS}=-48V, V_{GS}=0V$			-1	uA
		$V_{DS}=-48V, V_{GS}=0V$ $T_J=55^\circ C$			-5	
On-State Drain Current	$I_{D(on)}$	$V_{DS} \cong -10V, V_{GS}=-5V$	-30			A
Drain-source On-Resistance	$R_{DS(on)}$	$V_{GS}=-10V, I_D=-20A$		20	30	mΩ
		$V_{GS}=-4.5V, I_D=-20A$		27	40	
Forward Transconductance	g_{fs}	$V_{DS}=-50V, I_D=-7.8A$		33		S
Diode Forward Voltage	V_{SD}	$I_S=-7.8A, V_{GS}=0V$			-1.2	V
Dynamic						
Total Gate Charge	Q_g	$V_{DS}=-30V, V_{GS}=-10V$ $I_D=-20A$			58	nC
Gate-Source Charge	Q_{gs}			23		
Gate-Drain Charge	Q_{gd}			10		
Input Capacitance	C_{iss}	$V_{DS}=-30V, V_{GS}=0V$ $F=1MHz$			3600	pF
Output Capacitance	C_{oss}			240		
Reverse Transfer Capacitance	C_{rss}			153		
Turn-On Time	$t_{d(on)}$	$V_{GS}=-10V, V_{DS}=-30V$ $R_D=3\Omega, R_G=1.5\Omega$		12		nS
	t_r			15		
Turn-Off Time	$t_{d(off)}$				38	
	t_f			15		

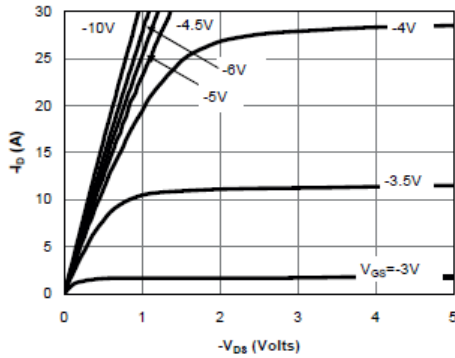
TYPICAL CHARACTERISTICS


Fig 1: On-Region Characteristics

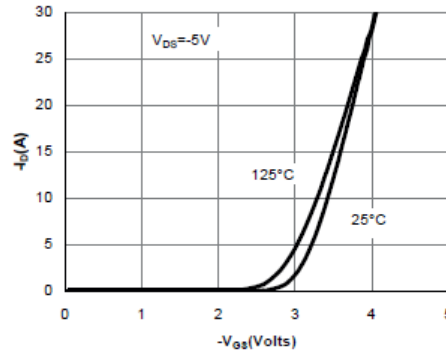


Figure 2: Transfer Characteristics

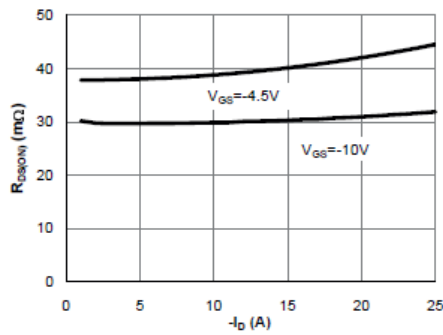


Figure 3: On-Resistance vs. Drain Current and Gate Voltage

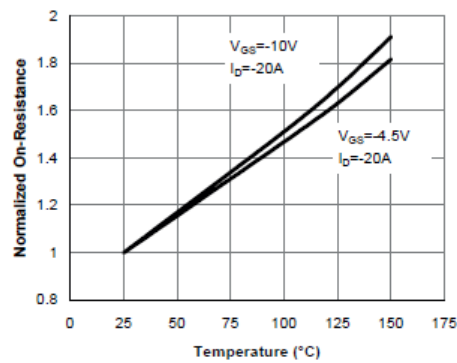


Figure 4: On-Resistance vs. Junction Temperature

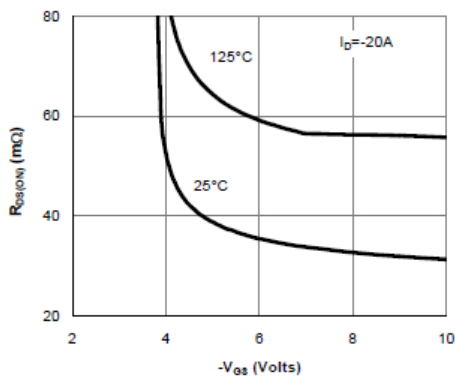


Figure 5: On-Resistance vs. Gate-Source Voltage

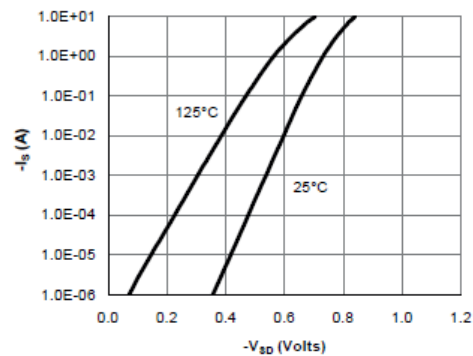


Figure 6: Body-Diode Characteristics

TYPICAL CHARACTERISTICS

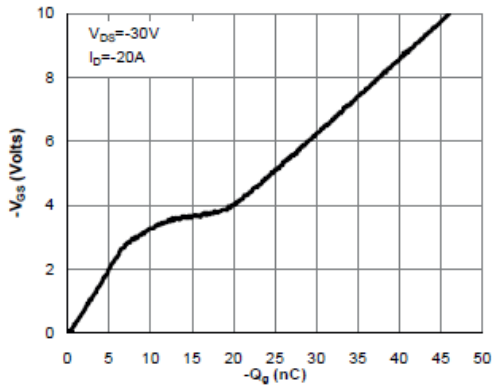


Figure 7: Gate-Charge Characteristics

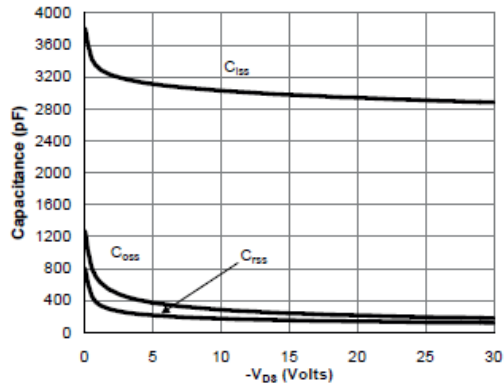


Figure 8: Capacitance Characteristics

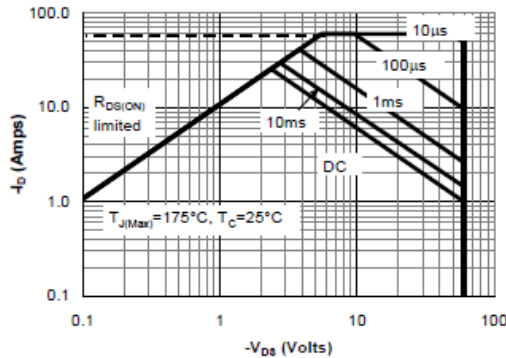


Figure 9: Maximum Forward Biased Safe Operating Area (Note F)

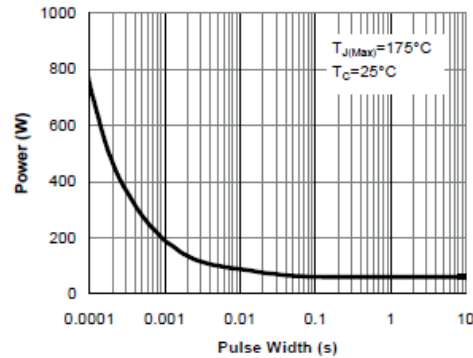


Figure 10: Single Pulse Power Rating Junction-to-Case (Note F)

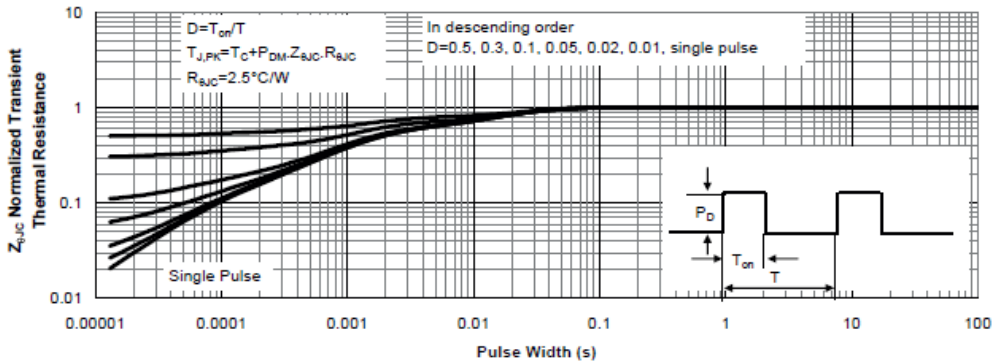
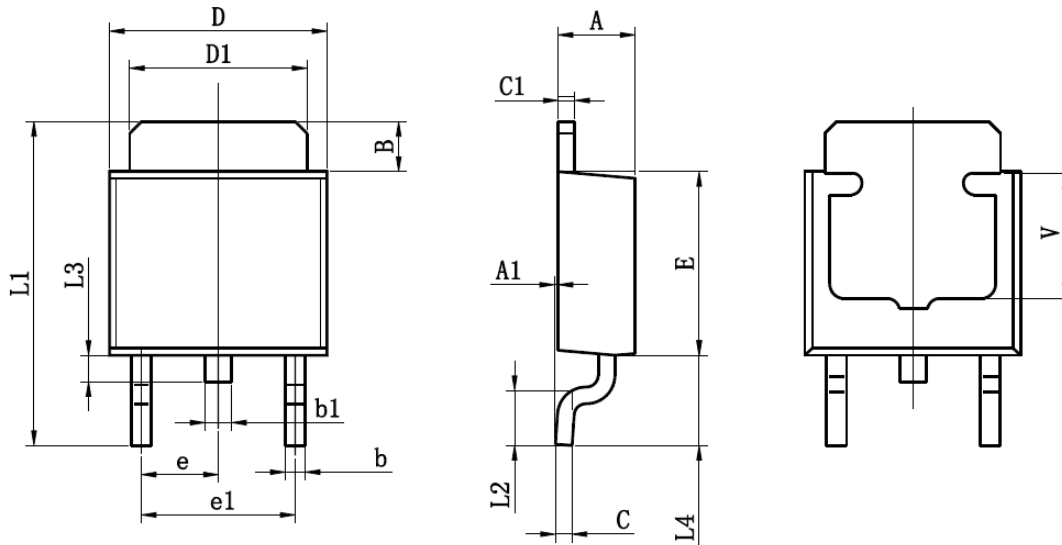
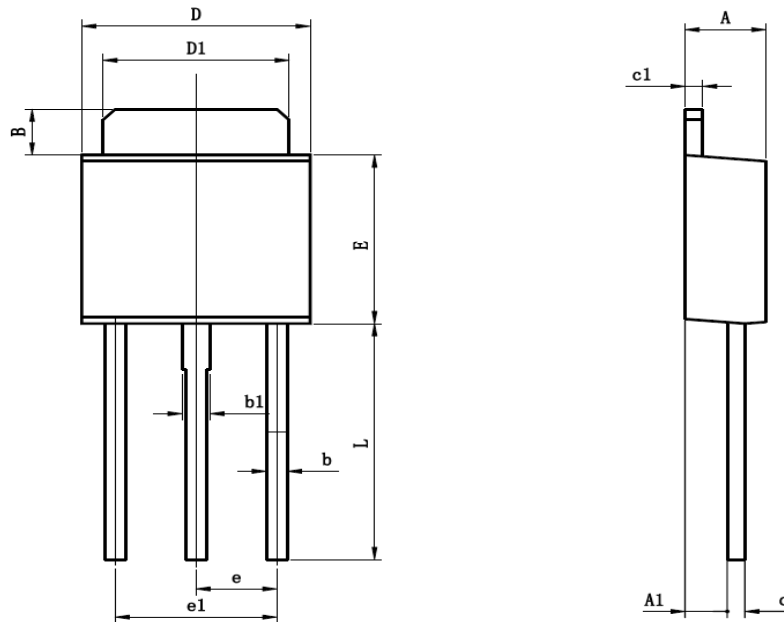


Figure 11: Normalized Maximum Transient Thermal Impedance (Note F)

TO-252-2L PACKAGE OUTLINE SOP-8P


Symbol	Dimensions In Millimeters		Dimensions In Inches	
	Min	Max	Min	Max
A	2.200	2.400	0.087	0.094
A1	0.000	0.127	0.000	0.005
B	1.350	1.650	0.053	0.065
b	0.500	0.700	0.020	0.028
b1	0.700	0.900	0.028	0.035
c	0.430	0.580	0.017	0.023
c1	0.430	0.580	0.017	0.023
D	6.350	6.650	0.250	0.262
D1	5.200	5.400	0.205	0.213
E	5.400	5.700	0.213	0.224
e	2.300TYP		0.091TYP	
e1	4.500	4.700	0.177	0.185
L1	9.500	9.900	0.374	0.390
L2	1.400	1.780	0.055	0.070
L3	0.650	0.950	0.026	0.037
L4	2.550	2.900	0.100	0.114
V	3.80REF		0.150REF	

TO-251 PACKAGE OUTLINE SOP-8P


Symbol	Dimensions In Millimeters		Dimensions In Inches	
	Min	Max	Min	Max
A	2.200	2.400	0.087	0.094
A1	1.020	1.270	0.040	0.050
B	1.350	1.650	0.053	0.065
b	0.500	0.700	0.020	0.028
b1	0.700	0.900	0.028	0.035
c	0.430	0.580	0.017	0.023
c1	0.430	0.580	0.017	0.023
D	6.350	6.650	0.250	0.262
D1	5.200	5.400	0.205	0.213
E	5.400	5.700	0.213	0.224
e	2.300TYP		0.091TYP	
e1	4.500	4.700	0.177	0.185
L	7.500	7.900	0.295	0.311