

Dual 650 V power Schottky silicon carbide diode in series

Datasheet - production data

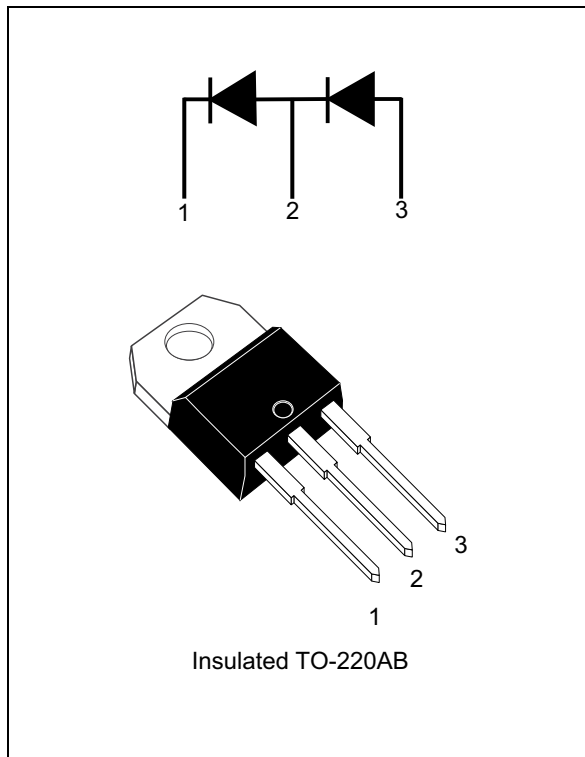

Description

The SiC diode is an ultrahigh performance power Schottky diode. It is manufactured using a silicon carbide substrate. The wide band gap material allows the design of a Schottky diode structure with a 650 V rating. Due to the Schottky construction, no recovery is shown at turn-off and ringing patterns are negligible. The minimal capacitive turn-off behavior is independent of temperature.

Especially suited for use in specific bridge-less topologies, this dual 650 V rectifier will boost the performance in hard switching conditions. Its high forward surge capability ensures a good robustness during transient phases.

Table 1. Device summary (per diode)

Symbol	Value
$I_{F(AV)}$	8 A
V_{RRM}	650 V
T_j (max.)	175 °C

Features

- No or negligible reverse recovery
- Switching behavior independent of temperature
- Suited for specific bridge-less topologies
- High forward surge capability
- Insulated package:
 - Capacitance: 7 pF
 - Insulated voltage: 2500 V rms

1 Characteristics

Table 2. Absolute ratings (limiting values at 25 °C unless otherwise specified, per diode)

Symbol	Parameter		Value	Unit
V_{RRM}	Repetitive peak reverse voltage		650	V
$I_{F(RMS)}$	Forward rms current		22	A
$I_{F(AV)}$	Average forward current	$T_c = 85\text{ °C}^{(1)}$, DC current	8	A
I_{FSM}	Surge non repetitive forward current	$t_p = 10\text{ ms}$ sinusoidal, $T_c = 25\text{ °C}$	75	A
		$t_p = 10\text{ ms}$ sinusoidal, $T_c = 125\text{ °C}$	69	
		$t_p = 10\text{ }\mu\text{s}$ sinusoidal, $T_c = 25\text{ °C}$	420	
I_{FRM}	Repetitive peak forward current	$T_c = 85\text{ °C}^{(1)}$, $\delta = 0.1$	33	A
T_{stg}	Storage temperature range		-55 to +175	°C
T_j	Operating junction temperature ⁽²⁾		-40 to +175	°C

- Value based on $R_{th(j-c)}$ max (per diode)
- $\frac{dP_{tot}}{dT_j} < \frac{1}{R_{th(j-a)}}$ condition to avoid thermal runaway for a diode on its own heatsink

Table 3. Thermal resistance

Symbol	Parameter		Typ.	Max.	Unit
$R_{th(j-c)}$	Junction to case	Per diode	3.5	4.3	°C/W
		Total	1.95	2.35	
$R_{th(c)}$				0.4	°C/W

When the diodes are used simultaneously:

$$\Delta T_{j(\text{diode}1)} = P_{(\text{diode}1)} \times R_{th(j-c)} \text{ (per diode)} + P_{(\text{diode}2)} \times R_{th(c)}$$

Table 4. Static electrical characteristics (per diode)

Symbol	Parameter	Tests conditions		Min.	Typ.	Max.	Unit
$I_R^{(1)}$	Reverse leakage current	$T_j = 25\text{ °C}$	$V_R = V_{RRM}$	-	7	80	μA
		$T_j = 150\text{ °C}$		-	65	335	
$V_F^{(2)}$	Forward voltage drop	$T_j = 25\text{ °C}$	$I_F = 8\text{ A}$	-	1.56	1.75	V
		$T_j = 150\text{ °C}$		-	1.98	2.5	

- Pulse test: $t_p = 10\text{ ms}$, $\delta < 2\%$
- Pulse test: $t_p = 500\text{ }\mu\text{s}$, $\delta < 2\%$

To evaluate the conduction losses use the following equation:

$$P = 1.35 \times I_{F(AV)} + 0.144 \times I_{F(RMS)}^2$$

Table 5. Dynamic electrical characteristics (per diode)

Symbol	Parameter	Test conditions	Typ.	Unit
$Q_{cj}^{(1)}$	Total capacitive charge	$V_R = 400\text{ V}$	23.5	nC
C_j	Total capacitance	$V_R = 0\text{ V}, T_C = 25\text{ }^\circ\text{C}, F = 1\text{ MHz}$	414	pF
		$V_R = 400\text{ V}, T_C = 25\text{ }^\circ\text{C}, F = 1\text{ MHz}$	38	

1. Most accurate value for the capacitive charge: $Q_{cj} = \int_0^{V_{OUT}} C_j(V_R).dV_R$

Figure 1. Forward voltage drop versus forward current (typical values, low level, per diode)

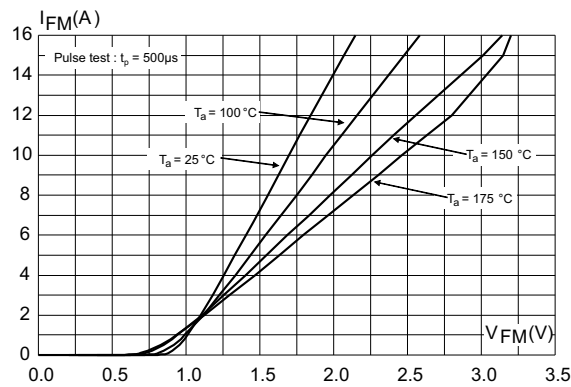

Figure 2. Forward voltage drop versus forward current (typical values, high level, per diode)

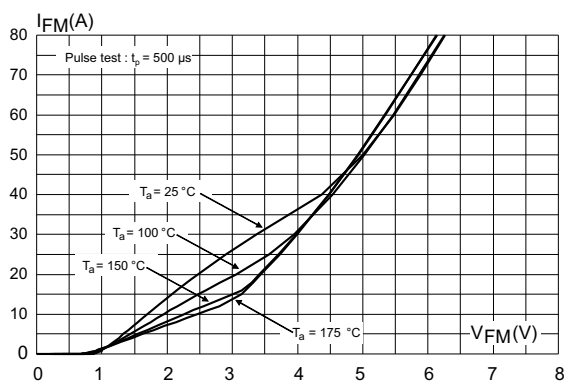

Figure 3. Reverse leakage current versus reverse voltage applied (typical values, per diode)

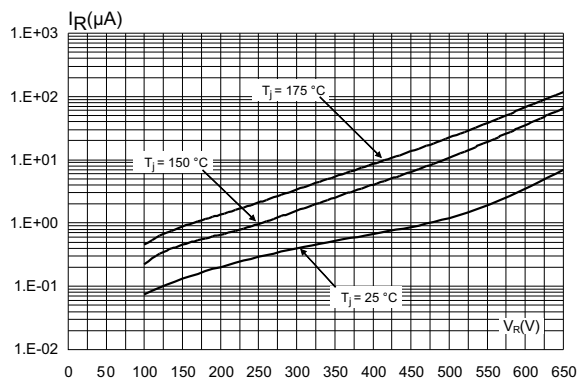

Figure 4. Peak forward current versus case temperature (per diode)

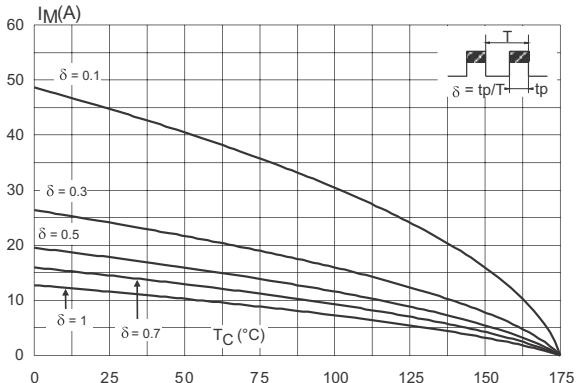

Figure 5. Junction capacitance versus reverse voltage applied (typical values, per diode)

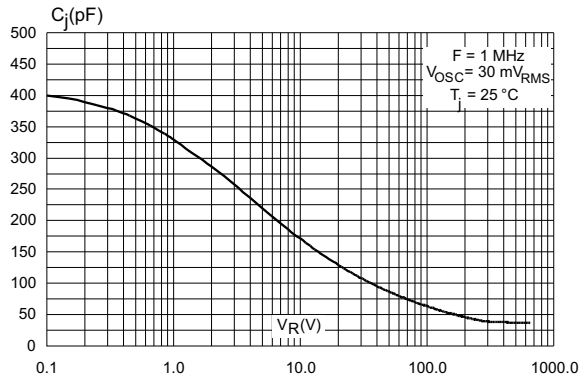

Figure 6. Relative variation of thermal impedance junction to case versus pulse duration

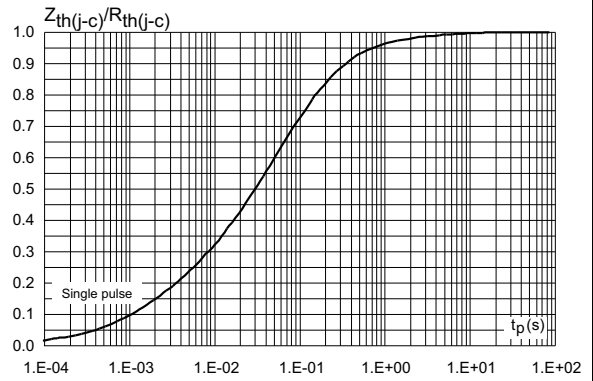

Figure 7. Non-repetitive peak surge forward current versus pulse duration (sinusoidal waveform, per diode)

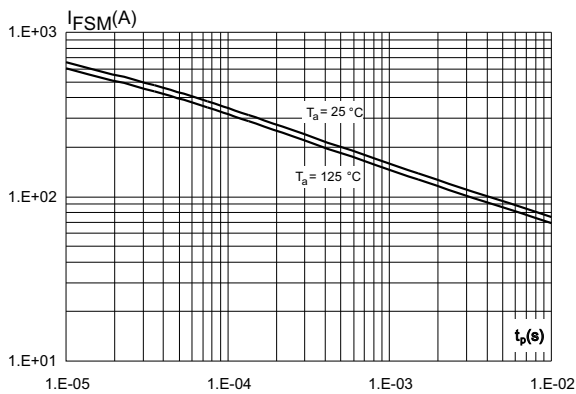
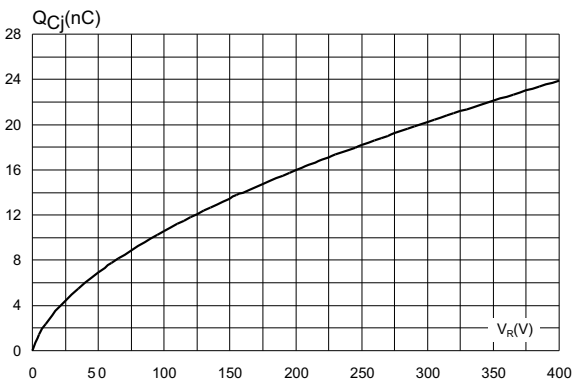

Figure 8. Total capacitive charges versus reverse voltage applied (typical values, per diode)



2 Package information

- Epoxy meets UL94, V0
- Lead-free package
- Cooling method: by conduction (C)
- Recommended torque value: 0.4 to 0.6 N·m

In order to meet environmental requirements, ST offers these devices in different grades of ECOPACK[®] packages, depending on their level of environmental compliance. ECOPACK[®] specifications, grade definitions and product status are available at: www.st.com. ECOPACK[®] is an ST trademark.

2.1 Insulated TO-220AB package information

Figure 9. Insulated TO-220AB package outline

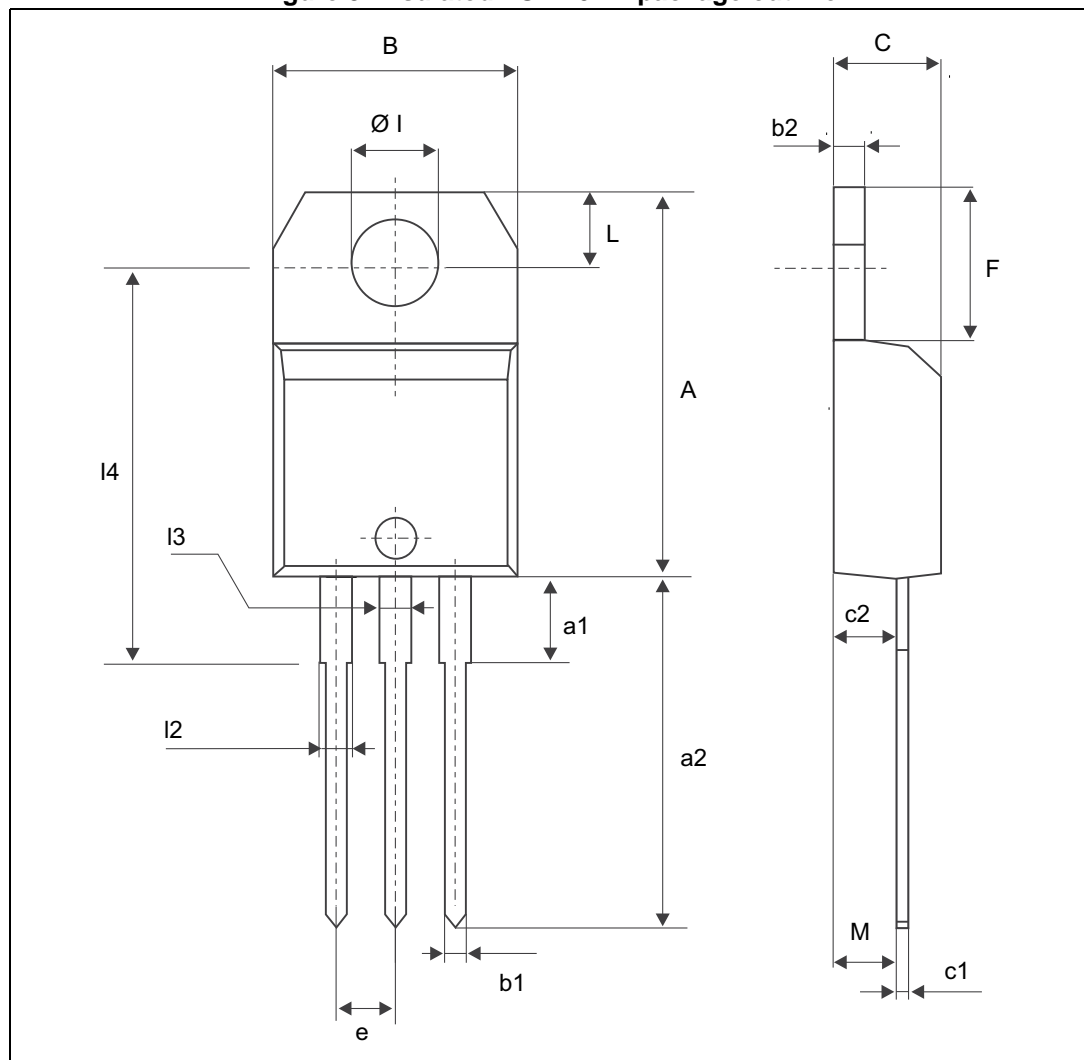

Table 6. Insulated TO-220AB package mechanical data

Ref.	Dimensions					
	Millimeters			Inches		
	Min.	Typ.	Max.	Min.	Typ.	Max.
A	15.20		15.90	0.598		0.625
a1		3.75			0.147	
a2	13.00		14.00	0.511		0.551
B	10.00		10.40	0.393		0.409
b1	0.61		0.88	0.024		0.034
b2	1.23		1.32	0.048		0.051
C	4.40		4.60	0.173		0.181
c1	0.49		0.70	0.019		0.027
c2	2.40		2.72	0.094		0.107
e	2.40		2.70	0.094		0.106
F	6.20		6.60	0.244		0.259
ØI	3.75		3.85	0.147		0.151
I4	15.80	16.40	16.80	0.622	0.646	0.661
L	2.65		2.95	0.104		0.116
I2	1.14		1.70	0.044		0.066
I3	1.14		1.70	0.044		0.066
M		2.60			0.102	

3 Ordering information

Table 7. Ordering information

Order code	Marking	Package	Weight	Base qty	Delivery mode
STPSC8TH13TI	STPSC 8TH13TI	Insulated TO-220AB	2.3g	50	Tube

4 Revision history

Table 8. Document revision history

Date	Revision	Changes
24-Jun-2013	1	First issue.
07-Nov-2013	2	Updated Figure 1 and Figure 2.
05-Jan-2016	3	Updated Table 7 . Format updated to current standard.

IMPORTANT NOTICE – PLEASE READ CAREFULLY

STMicroelectronics NV and its subsidiaries ("ST") reserve the right to make changes, corrections, enhancements, modifications, and improvements to ST products and/or to this document at any time without notice. Purchasers should obtain the latest relevant information on ST products before placing orders. ST products are sold pursuant to ST's terms and conditions of sale in place at the time of order acknowledgement.

Purchasers are solely responsible for the choice, selection, and use of ST products and ST assumes no liability for application assistance or the design of Purchasers' products.

No license, express or implied, to any intellectual property right is granted by ST herein.

Resale of ST products with provisions different from the information set forth herein shall void any warranty granted by ST for such product.

ST and the ST logo are trademarks of ST. All other product or service names are the property of their respective owners.

Information in this document supersedes and replaces information previously supplied in any prior versions of this document.

© 2016 STMicroelectronics – All rights reserved