

RFMD Green, RoHS Compliant, Pb-Free (Z Part Number)
 Package: TSSOP, 16-Pin, 5.0mmx6.4mmx1.0mm

Product Description

RFMD's STQ-2016 is a direct quadrature modulator targeted for use in a wide range of communications systems, including cellular/PCS, CDMA2000, UMTS, and ISM datacom. This device features a wide 700MHz to 2500MHz operating frequency band, excellent carrier and side-band suppression, and a low broadband noise floor.

The STQ-2016 uses silicon germanium (SiGe) device technology and delivers a typical output power of -11dBm with typical 60dB IM3 suppression. A digital input shut-down feature is included that, when enabled, attenuates the output by 60dB. The device is packaged in an industry standard 16-pin TSSOP with exposed paddle for superb RF and thermal ground.

Optimum Technology Matching® Applied

- GaAs HBT
- GaAs MESFET
- InGaP HBT
- SiGe BiCMOS
- Si BiCMOS
- SiGe HBT
- GaAs pHEMT
- Si CMOS
- Si BJT
- GaN HEMT
- InP HBT
- BiFET HBT
- LDMOS

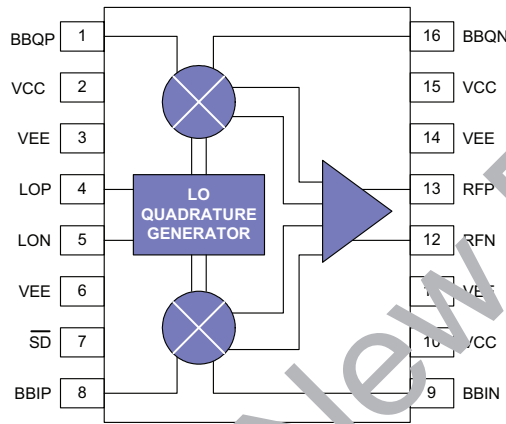

Features

- Excellent Carrier Feedthrough, -40dBm Constant with Output Power
- Output P1dB +3dBm
- Wide Baseband Input, DC to 500MHz
- Superior Phase Accuracy and Amplitude Balance, $\pm 0.5^\circ/\pm 0.2\text{dB}$
- Very Low Noise Floor, -155dBm/Hz
- Low LO Drive Requirement, -5dBm

Applications

- Cellular/PCS/CDMA2000/UMTS Transceivers
- ISM Band Transceivers, 900MHz and 2400MHz
- GMSK, QPSK, QAM, SSB Modulators

Parameter	Unit	700MHz to 1000MHz			1700MHz to 2500MHz			Comments
		Min.	Typ.	Max.	Min.	Typ.	Max.	
RF Output: $T_A = 25^\circ\text{C}$								
RF Frequency Range	MHz	700		1000	1700		2500	
Output Power	dBm	-13.0	-10.5	-9.0	-15.0	-11.5	-9.0	Baseband 200kHz @ 600mV _{P-P} differential
RF Port Return Loss	dB		20			16		Matched to 50Ω (refer to schematics on pages 6 and 7)
Output P1dB	dBm	+3	+4		0	+3		(I/Q inputs = 3.74V _{P-P} differential typical)
Carrier Feedthrough	dBm		-40	-34		-40	-32	
Sideband Suppression	dB	34	40		34	40		
IM3 Suppression	dB	55	60		55	60		Two-tone baseband input @ 600mV _{P-P} differential per tone
Broadband Noise Floor	dBm/Hz		-154	-152		-155	-153	Baseband inputs tied to 1.9V _{DC} , -20MHz offset from carrier
Quadrature Phase Error	deg	-2.0	± 0.5	+2.0	-2.0	± 0.5	+2.0	
I/Q Amplitude Balance	dB	-0.20	± 0.05	+0.20	-0.20	± 0.05	+0.20	
Supply Voltage (V _{CC})	V	+4.75	+5.00	+5.25	+4.75	+5.00	+5.25	
Supply Current	mA		73	86		73	86	
Device Thermal Resistance	$^\circ\text{C/W}$		25			25		

Absolute Maximum Ratings

Parameter	Rating	Unit
Supply Voltage (V_{CC})	6.0	V_{DC}
LO, RF Input (LOP, LON, RFP, RFN)	+10	dBm
Baseband Min Input Voltage (BBIP, BBIN, BBQP, BBQN)	0	V_{DC}
Baseband Max Input Voltage (BBIP, BBIN, BBQP, BBQN)	3	V_{DC}
Operating Temperature	-40 to +85	$^{\circ}C$
Storage Temperature	-65 to +150	$^{\circ}C$



Caution! ESD sensitive device.

Exceeding any one or a combination of the Absolute Maximum Rating conditions may cause permanent damage to the device. Extended application of Absolute Maximum Rating conditions to the device may reduce device reliability. Specified typical performance or functional operation of the device under Absolute Maximum Rating conditions is not implied.

RoHS status based on EU Directive 2002/95/EC (at time of this document revision).

The information in this publication is believed to be accurate and reliable. However, no responsibility is assumed by RF Micro Devices, Inc. ("RFMD") for its use, nor for any infringement of patents, or other rights of third parties, resulting from its use. No license is granted by implication or otherwise under any patent or patent rights of RFMD. RFMD reserves the right to change component circuitry, recommended application circuitry and specifications at any time without prior notice.

Operation of this device beyond any one of these limits may cause permanent damage. For reliable continuous operation, the device voltage and current must not exceed the maximum operating values specified in the table on page one.

Parameter	Specification			Unit	Condition
	Min.	Typ.	Max.		
Product Specifications					
Baseband Modulation Input: $T_A = 25^{\circ}C$					
Baseband Frequency Input	DC		500	MHz	-3 dB Bandwidth, baseband inputs terminated in 50 Ω
Baseband Input Resistance		4.4		k Ω	per pin
Baseband Input Capacitance		0.5		pF	per pin
Product Specifications					
LO Input: $T_A = 25^{\circ}C$					
LO Frequency	700		2500	MHz	
LO Drive Level	-8	-5	-2	dBm	
LO Port Return Loss		16		dB	Matched to 50 Ω (refer to schematics)
Product Specifications					
Miscellaneous: $T_A = 25^{\circ}C$					
Shut-Down Attenuation		60		dB	
Shut-Down Pin Resistance		11.9		k Ω	at 1MHz
Shut-Down Pin Capacitance		5.2		pF	at 1MHz
Shut-Down Control Voltage Thresholds	3.75		V_{CC}	V	Shut-Down disabled (normal operation)
Shut-Down Control Voltage Thresholds	0.0		1.5	V	Shut-Down enabled
Shut-Down Settling Time		<450		ns	
Test Conditions: (for all product specifications unless otherwise noted) V_{CC} (pins 2, 10, 15): +5V, $T_A = +25^{\circ}C$, Baseband Input (pins 1, 8, 9, 18): 1.9V DC bias, 200kHz frequency; 300mVp-p per pin = 600mVp-p differential drive, I and Q signals in quadrature, LO Input (pins 4, 5) = -5dBm at 1960MHz					

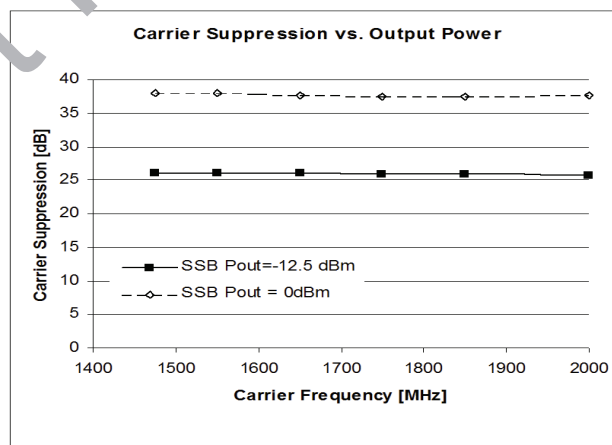

700MHz to 1000MHz Typical Device Performance

SSB Power vs. LO Frequency

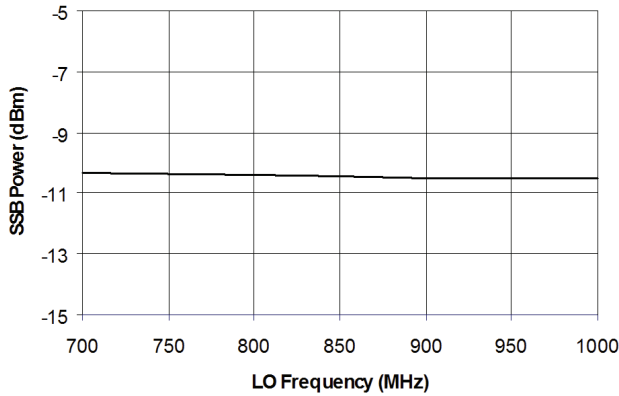

Output P1dB vs. LO Frequency

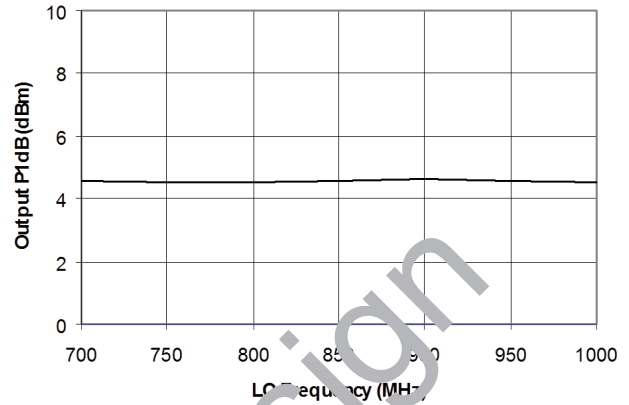

Carrier Feedthrough vs. LO Frequency

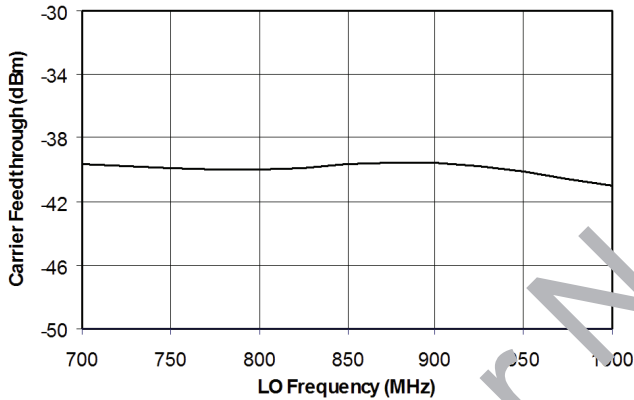

Sideband Suppression vs. LO Frequency

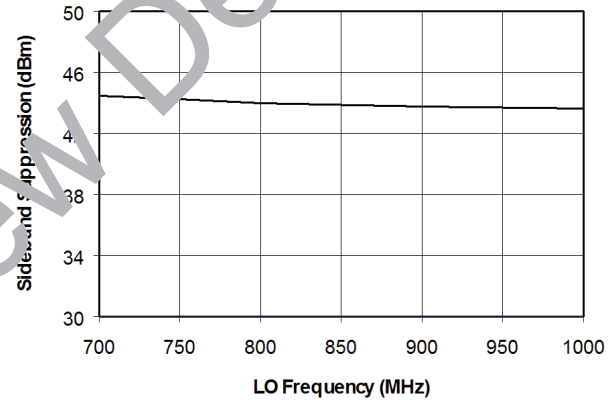

Intermodulation Distortion vs. SSB Output Power @ 30 MHz

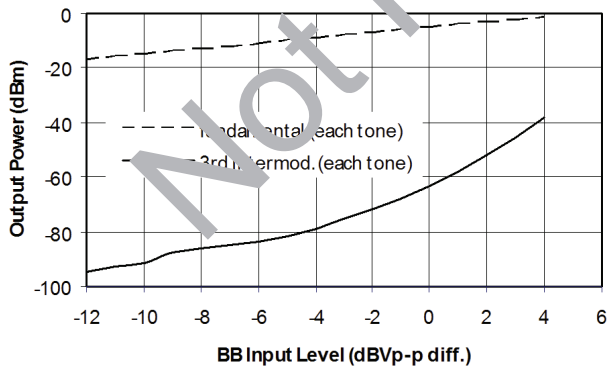

RF & LO Port Return Losses

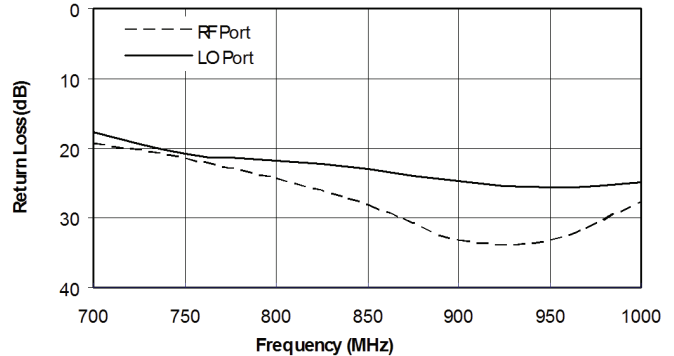

1500MHz to 2500MHz Typical Device Performance

SSB Power vs. LO Frequency

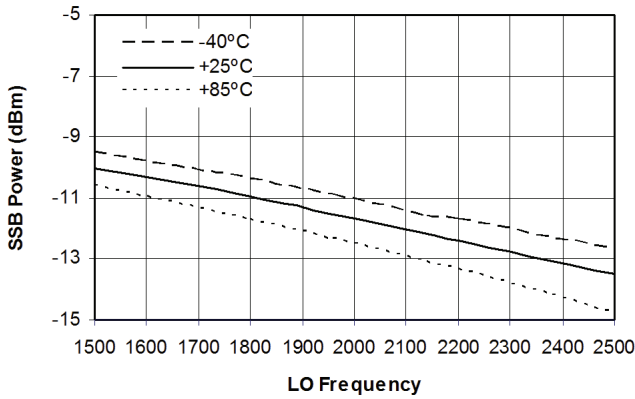

Output P1dB vs. LO Frequency

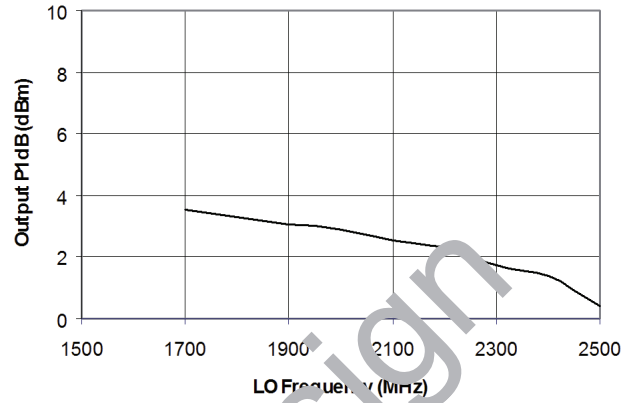

Carrier Feedthrough vs. LO Frequency

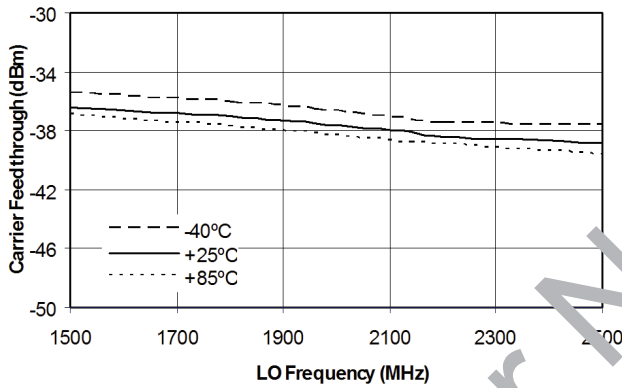

Sideband Suppression vs. LO Frequency

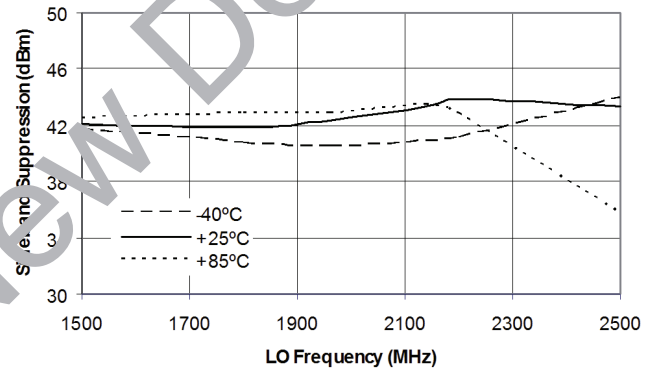

Intermodulation Distortion vs. SSB Output Power @ 1960 MHz

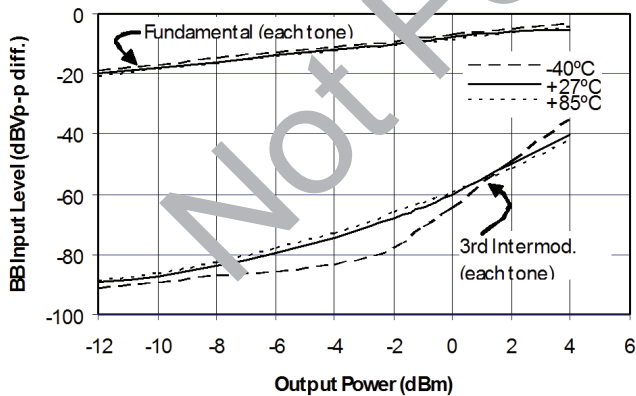

RF & LO Port Return Losses

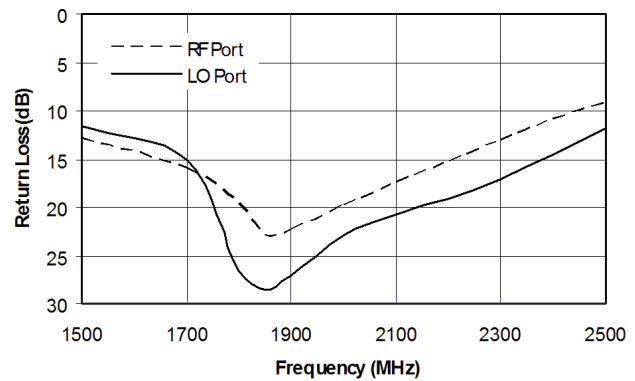

Pin	Function	Description
1	BBQP	Q-channel baseband input, positive terminal. Nominal DC voltage is 1.9V (biased internally).
2, 10, 15	VCC	Positive supply (+5V).
3, 6, 11, 14	VEE	Ground.
4	LOP	Local oscillator input, positive terminal. Nominal DC voltage is 2.0V. Input should be AC-coupled.
5	LON	Local oscillator input, negative terminal. Nominal DC voltage is 2.0V. Input should be AC-coupled.
7	SD	Shut-down control. Logic high=normal operation; logic low=shut-down enabled.
8	BBIP	I-channel baseband input, positive terminal. Nominal DC bias voltage is 1.9V (biased internally).
9	BBIN	I-channel baseband input, negative terminal. Nominal DC bias voltage is 1.9V (biased internally).
12	RFN	RF output, negative terminal. Nominal DC voltage is 2.4V. Output should be AC-coupled.
13	RFP	RF output, positive terminal. Nominal DC voltage is 2.4V. Output should be AC-coupled.
16	BBQN	Q-channel baseband input, negative terminal. Nominal DC bias voltage is 1.9V (biased internally).

Suggested Pad Layout

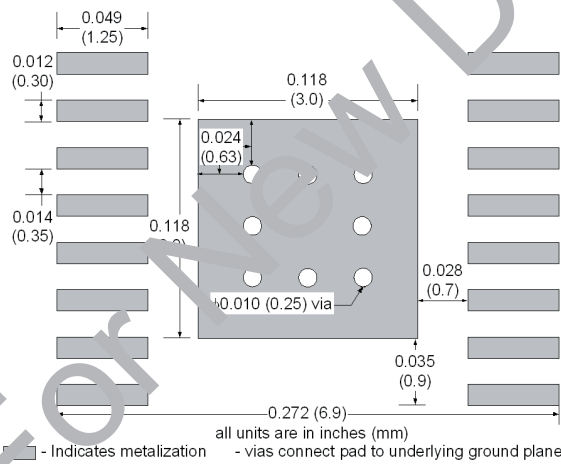

Package Drawing

Dimensions in inches (millimeters)
Refer to drawing posted at www.rfmd.com for tolerances.

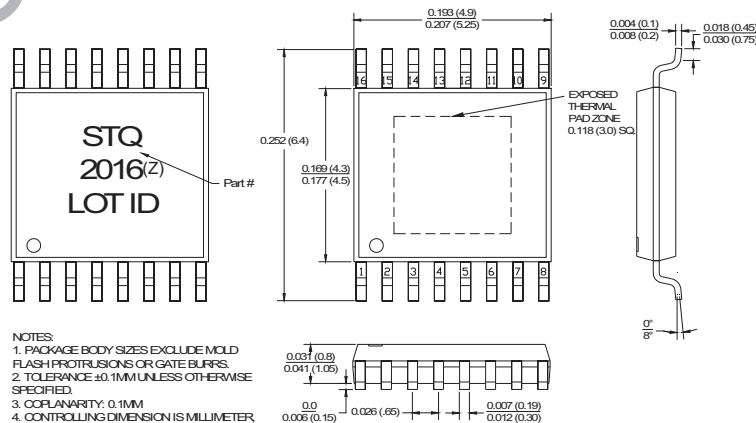

- NOTES:
1. PACKAGE BODY SIZES EXCLUDE MOLD FLASH PROTRUSIONS OR GATE BURRS.
 2. TOLERANCE ±0.1MM UNLESS OTHERWISE SPECIFIED.
 3. COPPLANARITY: 0.1MM
 4. CONTROLLING DIMENSION IS MILLIMETER, CONVERTED INCH DIMENSIONS ARE NOT NECESSARILY EXACT.
 5. FOLLOWED FROM JEDEC MO-153.

700 MHz to 1000 MHz Application Schematic

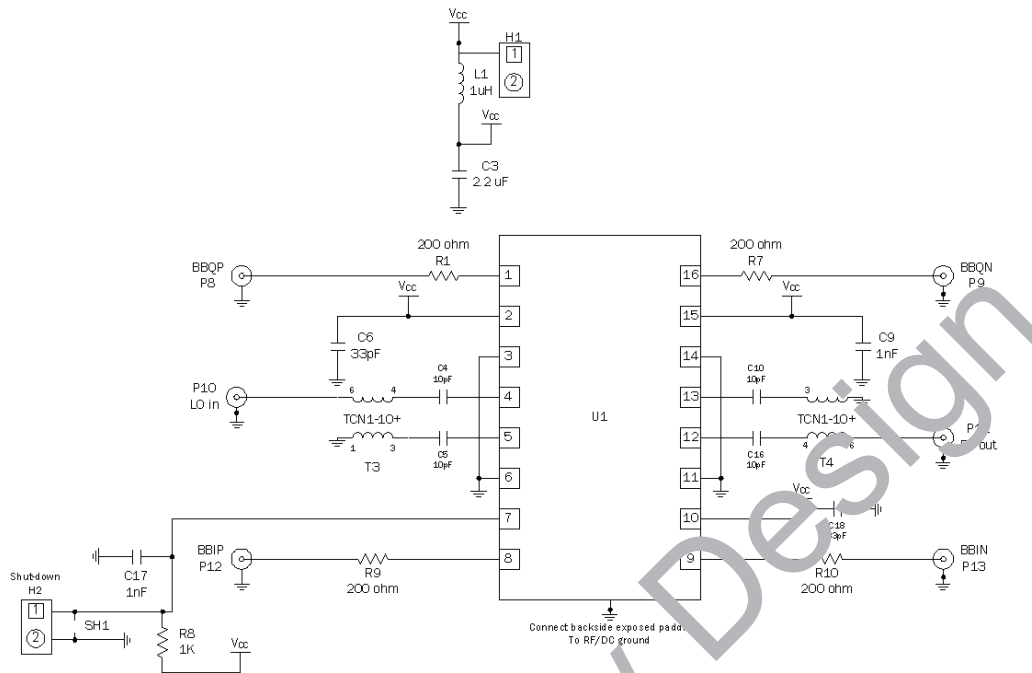

Bill of Materials (for 700MHz to 1000MHz Evaluation Board P/N STQ-2016(Z) EVB-1)

Qty	Description	Ref. Designator	Manufacturer	Mfg Part Number	Sub Ok?
1	SiGe (HBT) Quad Modulator, 70mA	U1	RFMD	STQ-2016	N
6	CONN, SMA END LAUNCH, 0.062"	P8, 9, 10, 11, 12, 13	Johnson Components, INC	142-0701-851	Y
2	2-pin header, right angle	H1, H2	MOLEX	68142-0221	Y
1	PCB, 2016		DDI	STQ2016410(A)	N
2	RF transformer, 680-1050MHz	T3, T4	Mini-Circuits	TCN1-10+	N
1	Inductor, 1210 footprint, ±10% tol. 1 uH	L1	Panasonic	ELJ-FA1R0KF2	Y
4	Resistor, 1206 footprint, ±10% tol. 20 Ω	R1, 7, 9, 10	Panasonic	ERJ-8ENF2000	Y
1	Resistor, 0603 footprint, ±1% tol. 1K Ω	R8	Panasonic	ERA-3YEB102V	Y
2	Capacitor, 0603 footprint, ±5% tol. 33pF	C6, C18	Panasonic	ECJ-1VC1H330J	Y
2	Capacitor, 0603 footprint, ±5% tol. 1nF	C9, 17	Panasonic	ECJ-1VB2A102K	Y
1	CAP, 2.2 uF, 10%, 10V, X7R, 0603	C3	Murata Electronics	GRM188R61A225KE34D	Y
4	Capacitor, 0603 footprint, ±5% tol. 10pF	C4, 5, 10, 16	Panasonic	ECJ-1VC1H100D	Y
1	Shunt for two pin header	SH1	3M	929950-00	Y

Fully Assembled PCB

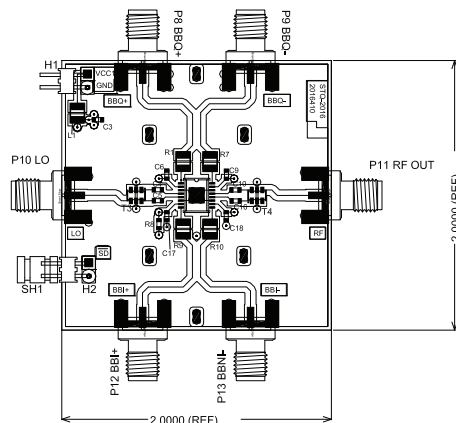

1.7 GHz to 2.5 GHz Application Schematic

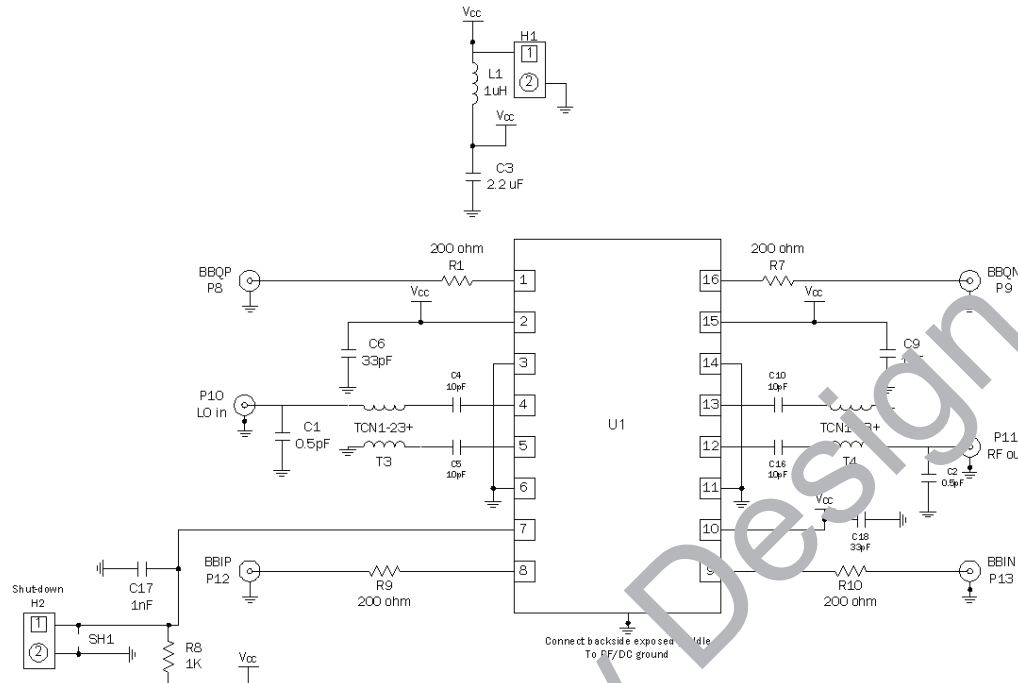

Bill of Materials (for 1700MHz to 2500MHz Evaluation Board P/N STQ-2016EVB2)

Qty	Description	Ref. Designator	Manufacturer	Mfg Part Number	Sub Ok?
1	SiGe (HBT) Quad Modulator, 70mA	U1	RFMD	STQ-2016	N
6	CONN, SMA END LAUNCH, 0.062"	P8, 9, 10, 11, 12, 13	Johnson Components, INC	142-0701-851	Y
2	2-pin header, right angle	H1, H2	MOLEX	68142-0221	Y
1	PCB, 2016		DDI	STQ2016410(A)	N
2	RF transformer, 1300-2300MHz	T3, T4	Mini-Circuits	TCN1-23+	N
1	Inductor, 1210 footprint, ±10% tol. 1uH	L1	Panasonic	ELJ-FA1R0KF2	Y
4	Resistor, 1206 footprint, ±1% tol. 100Ω	R1, 7, 9, 10	Panasonic	ERJ-8ENF2000	Y
1	Resistor, 0603 footprint, ±1% tol. 1KΩ	R8	Panasonic	ERA-3YEB102V	Y
2	Capacitor, 0603 footprint, ±5% tol. 33pF	C6, C18	Panasonic	ECJ-1VC1H330J	Y
2	Capacitor 0603 footprint, ±5% tol. 0.5pF	C1, C2	Murata	GRM1885C1HR050BZ01D	Y
2	Capacitor, 0603 footprint, ±5% tol. 1nF	C9, 17	Panasonic	ECJ-1VB2A102K	Y
1	CAP, 2.2uF, 10% 10V, X5R, 0603	C3	Murata Electronics	GRM188R61A225KE34D	Y
4	Capacitor, 0603 footprint, ±5% tol. 10pF	C4, 5, 10, 16	Panasonic	ECJ-1VC1H100D	Y
1	Shunt for two pin header	SH1	3M	929950-00	Y

Fully Assembled PCB

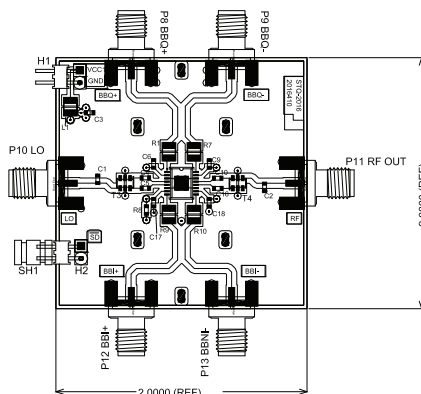

Direct Quadrature Modulator: General Test Set-Up

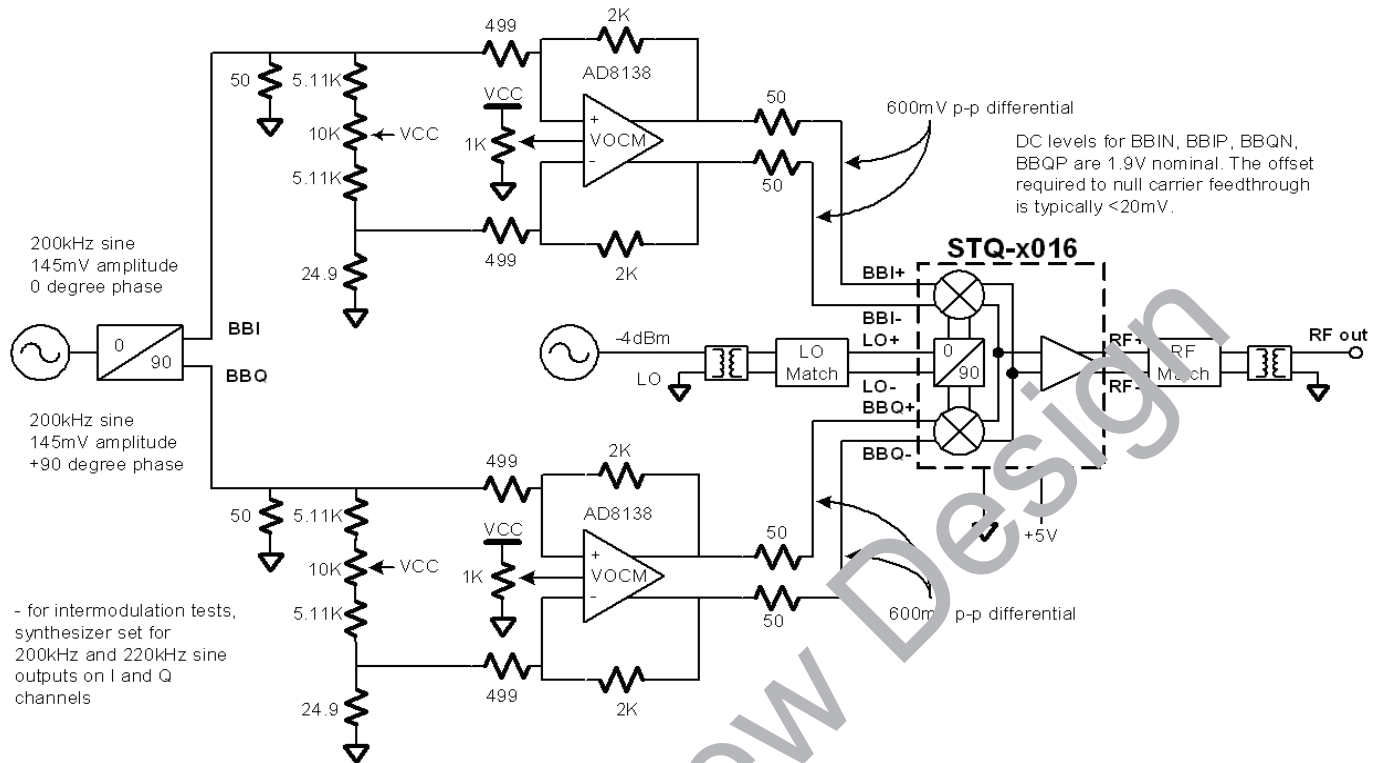

Ordering Information

Part Number	Reel Size	Devices/Reel
STQ-2016	7"	1000
STQ-2016Z	7"	1000