

N-channel 600 V, 4 Ω typ., 0.6 A MDmesh™ K3 Power MOSFET in a TO-92 package

Datasheet - production data

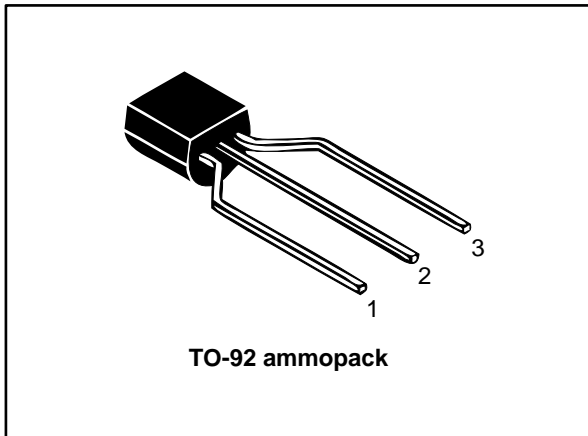
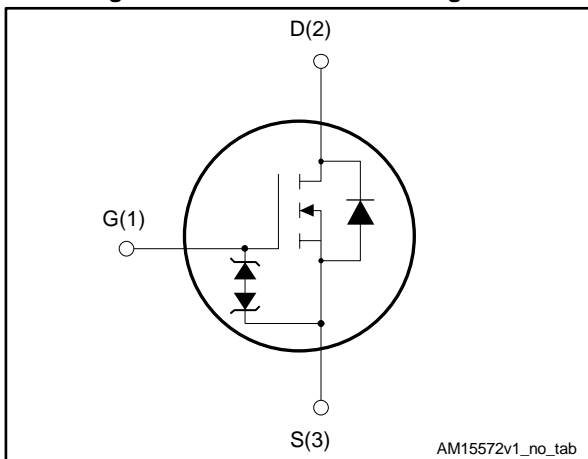

Figure 1: Internal schematic diagram



Features

Order code	V _{DS}	R _{DS(on)} max	I _D	P _{TOT}
STQ2LN60K3-AP	600 V	4.5 Ω	0.6 A	2.5 W

- 100% avalanche tested
- Extremely high dv/dt capability
- Very low intrinsic capacitance
- Improved diode reverse recovery characteristics
- Zener-protected

Applications

- Switching applications

Description

This MDmesh™ K3 Power MOSFET is the result of improvements applied to STMicroelectronics' MDmesh™ technology, combined with a new optimized vertical structure. This device boasts an extremely low on-resistance, superior dynamic performance and high avalanche capability, rendering it suitable for the most demanding applications.

Table 1: Device summary

Order code	Marking	Package	Packaging
STQ2LN60K3-AP	2LN60K3	TO-92	Ampmpack

Contents

1	Electrical ratings	3
2	Electrical characteristics	4
	2.1 Electrical characteristics (curves)	6
3	Test circuits	9
4	Package information	10
	4.1 TO-92 ammpack package information	10
5	Revision history	12

1 Electrical ratings

Table 2: Absolute maximum ratings

Symbol	Parameter	Value	Unit
V_{DS}	Drain-source voltage	600	V
V_{GS}	Gate-source voltage	± 30	V
I_D	Drain current (continuous) at $T_C = 25\text{ }^\circ\text{C}$	0.6	A
I_D	Drain current (continuous) at $T_C = 100\text{ }^\circ\text{C}$	0.38	A
$I_{DM}^{(1)}$	Drain current (pulsed)	2.4	A
P_{TOT}	Total dissipation at $T_C = 25\text{ }^\circ\text{C}$	2.5	W
$dv/dt^{(2)}$	Peak diode recovery voltage slope	12	V/ns
T_{stg}	Storage temperature range	-55 to 150	$^\circ\text{C}$
T_j	Operating junction temperature range		

Notes:

(1) Pulse width limited by safe operating area.

(2) $I_{SD} \leq 2\text{ A}$, $di/dt \leq 400\text{ A}/\mu\text{s}$, $V_{DS(\text{peak})} < V_{(BR)DSS}$

Table 3: Thermal data

Symbol	Parameter	Value	Unit
$R_{thj\text{-case}}$	Thermal resistance junction-case	50	$^\circ\text{C}/\text{W}$
$R_{thj\text{-amb}}$	Thermal resistance junction-ambient	120	$^\circ\text{C}/\text{W}$

Table 4: Avalanche characteristics

Symbol	Parameter	Value	Unit
I_{AS}	Single pulse avalanche current (pulse width limited by $T_{j\text{max}}$)	2	A
E_{AS}	Single pulse avalanche energy (starting $T_J=25\text{ }^\circ\text{C}$, $I_D=I_{AR}$, $V_{DD}=50\text{ V}$)	80	mJ

2 Electrical characteristics

(T_{CASE} = 25 °C unless otherwise specified)

Table 5: On/off states

Symbol	Parameter	Test conditions	Min.	Typ.	Max.	Unit
V _{(BR)DSS}	Drain-source breakdown voltage	I _D = 1 mA, V _{GS} = 0 V	600			V
I _{DSS}	Zero gate voltage drain current	V _{GS} = 0 V, V _{DS} = 600 V			1	μA
		V _{GS} = 0 V, V _{DS} = 600 V, T _C = 125 °C ⁽¹⁾			50	
I _{GSS}	Gate-body leakage current	V _{DS} = 0 V, V _{GS} = ±20 V			±10	μA
V _{GS(th)}	Gate threshold voltage	V _{DS} = V _{GS} , I _D = 50 μA	3	3.75	4.5	V
R _{DS(on)}	Static drain-source on-resistance	V _{GS} = 10 V, I _D = 1 A		4	4.5	Ω

Notes:

⁽¹⁾Defined by design, not subject to production test.

Table 6: Dynamic

Symbol	Parameter	Test conditions	Min.	Typ.	Max.	Unit
C _{iss}	Input capacitance	V _{DS} = 50 V, f = 1 MHz, V _{GS} = 0 V	-	235	-	pF
C _{oss}	Output capacitance		-	22	-	pF
C _{rss}	Reverse transfer capacitance		-	3.5	-	pF
C _{o(tr)} ⁽¹⁾	Eq. capacitance time related	V _{GS} = 0 V, V _{DS} = 0 to 480 V	-	14	-	pF
C _{o(er)} ⁽²⁾	Eq. capacitance energy related		-	10		pF
Q _g	Total gate charge	V _{DD} = 480 V, I _D = 1 A, V _{GS} = 0 to 10 V (see Figure 16: "Test circuit for gate charge behavior")	-	12	-	nC
Q _{gs}	Gate-source charge		-	1.8	-	nC
Q _{gd}	Gate-drain charge		-	7.7	-	nC
R _G	Gate input resistance	f=1 MHz, I _D =0 A	-	7	-	Ω

Notes:

⁽¹⁾C_{oss eq.} time related is defined as a constant equivalent capacitance giving the same charging time as C_{oss} when V_{DS} increases from 0 to 80% V_{DSS}

⁽²⁾C_{oss eq.} energy related is defined as a constant equivalent capacitance giving the same stored energy as C_{oss} when V_{DS} increases from 0 to 80% V_{DSS}

Table 7: Switching times

Symbol	Parameter	Test conditions	Min.	Typ.	Max.	Unit
$t_{d(on)}$	Turn-on delay time	$V_{DD} = 300\text{ V}$, $I_D = 1\text{ A}$, $R_G = 4.7\ \Omega$, $V_{GS} = 10\text{ V}$ (see Figure 15 : "Test circuit for resistive load switching times" and Figure 20 : "Switching time waveform")	-	10	-	ns
t_r	Rise time		-	8.5	-	ns
$t_{d(off)}$	Turn-off delay time		-	23.5	-	ns
t_f	Fall time		-	21	-	ns

Table 8: Source-drain diode

Symbol	Parameter	Test conditions	Min.	Typ.	Max.	Unit
$I_{SD}^{(1)}$	Source-drain current		-		0.6	A
$I_{SDM}^{(1)}$	Source-drain current (pulsed)		-		2.4	A
$V_{SD}^{(2)}$	Forward on voltage	$I_{SD} = 2\text{ A}$, $V_{GS} = 0\text{ V}$	-		1.5	V
t_{rr}	Reverse recovery time	$I_{SD} = 2\text{ A}$, $di/dt = 100\text{ A}/\mu\text{s}$ $V_{DD} = 60\text{ V}$ (see Figure 17 : "Test circuit for inductive load switching and diode recovery times")	-	200		ns
Q_{rr}	Reverse recovery charge		-	800		nC
I_{RRM}	Reverse recovery current		-	8		A
t_{rr}	Reverse recovery time	$I_{SD} = 2\text{ A}$, $di/dt = 100\text{ A}/\mu\text{s}$ $V_{DD} = 60\text{ V}$, $T_j = 150\text{ }^\circ\text{C}$ (see Figure 17 : "Test circuit for inductive load switching and diode recovery times")	-	230		ns
Q_{rr}	Reverse recovery charge		-	950		nC
I_{RRM}	Reverse recovery current		-	8.5		A

Notes:

(1)Pulse width limited by safe operating area.

(2)Pulsed: pulse duration = 300 μs , duty cycle 1.5%

Table 9: Gate-source Zener diode

Symbol	Parameter	Test conditions	Min.	Typ.	Max.	Unit
$V_{(BR)GSO}$	Gate-source breakdown voltage	$I_{GS} = \pm 1\text{ mA}$, $I_D = 0\text{ A}$	30	-	-	V

The built-in back-to-back Zener diodes are specifically designed to enhance the ESD performance of the device. The Zener voltage facilitates efficient and cost-effective device integrity protection, thus eliminating the need for additional external componentry.

2.1 Electrical characteristics (curves)

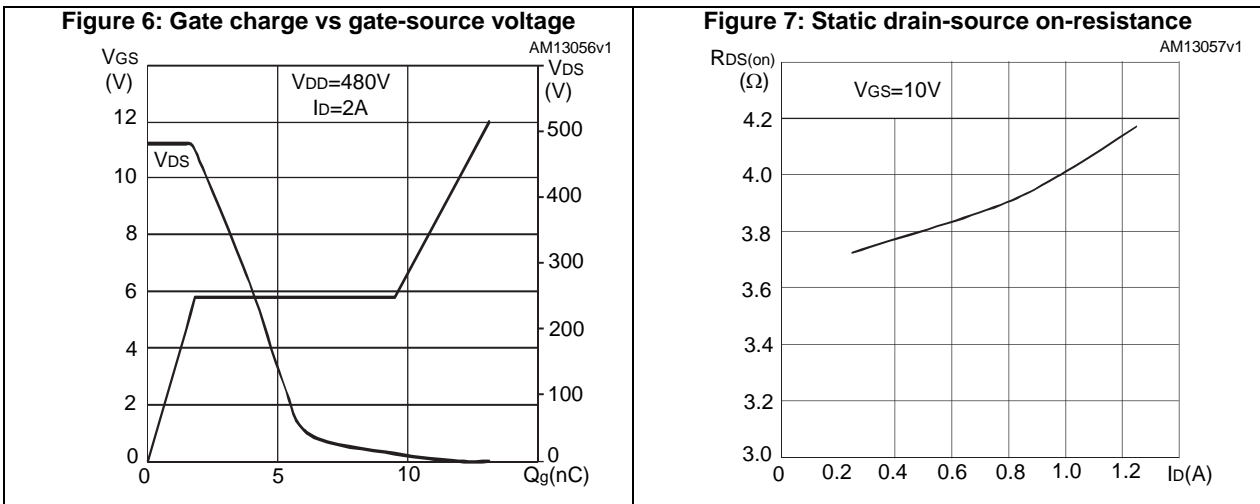
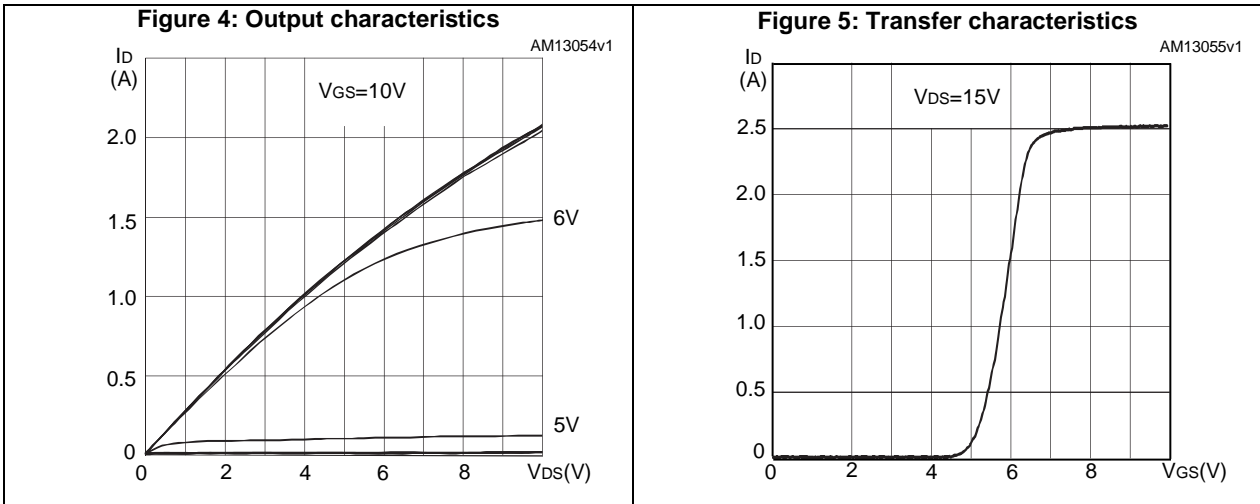
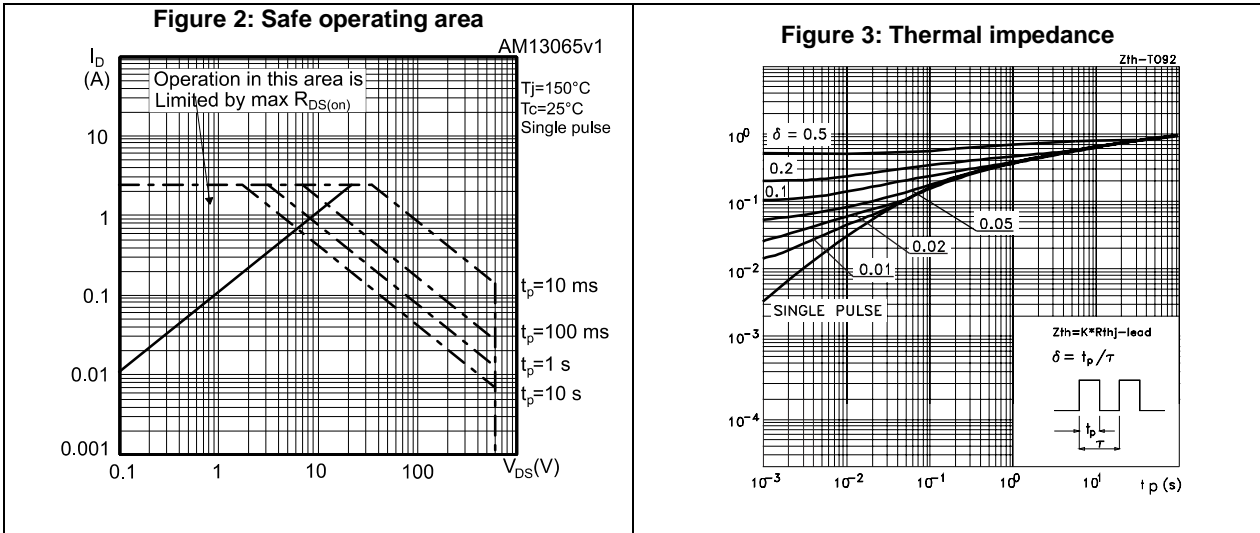

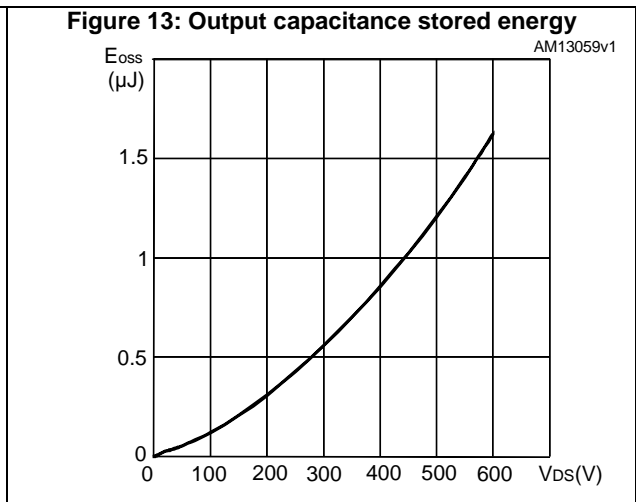
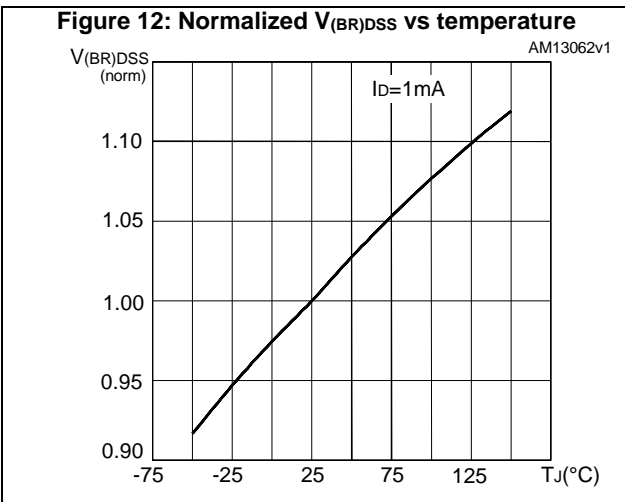
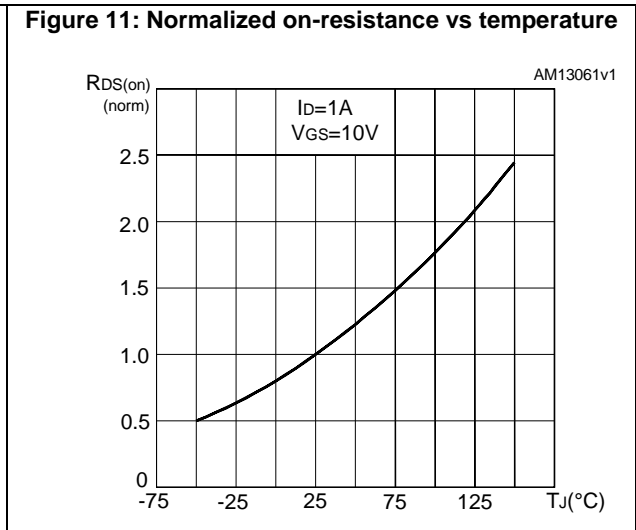
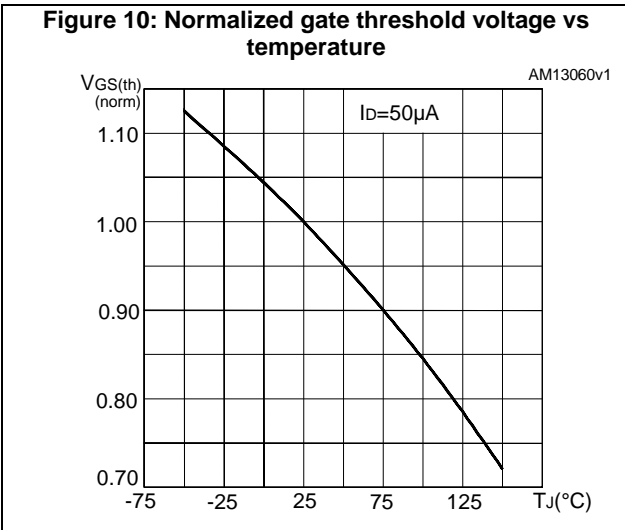
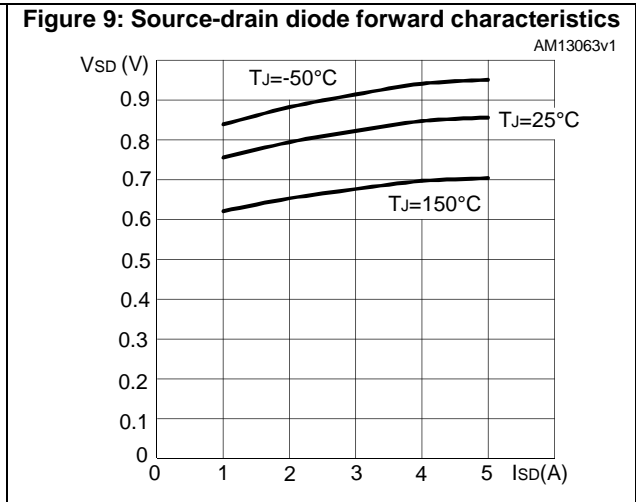
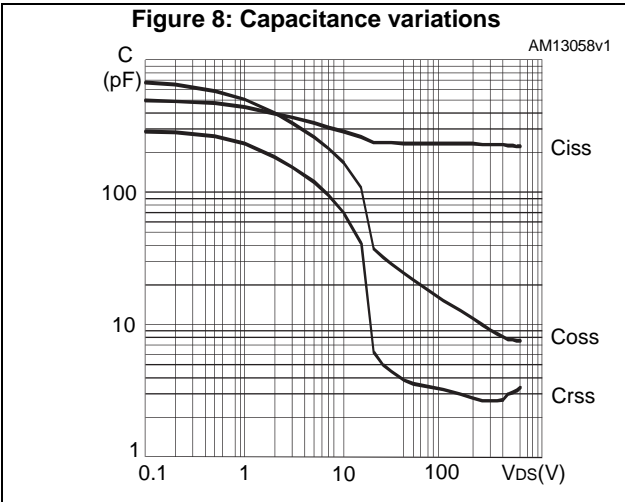
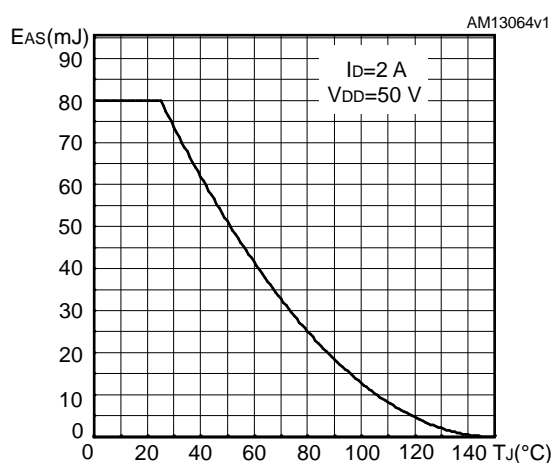
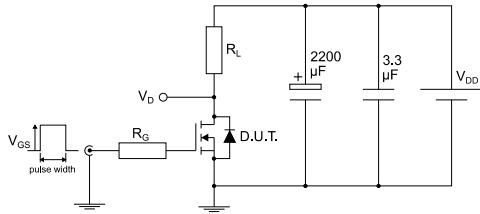

Figure 14: Maximum avalanche energy vs temperature



3 Test circuits

Figure 15: Test circuit for resistive load switching times



AM01468v1

Figure 16: Test circuit for gate charge behavior

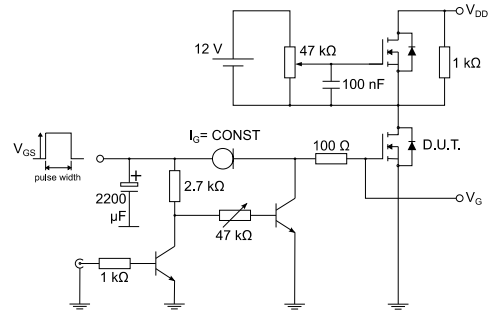

AM01469v1

Figure 17: Test circuit for inductive load switching and diode recovery times

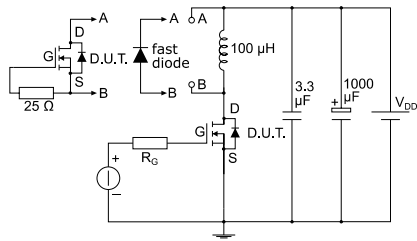

AM01470v1

Figure 18: Unclamped inductive load test circuit

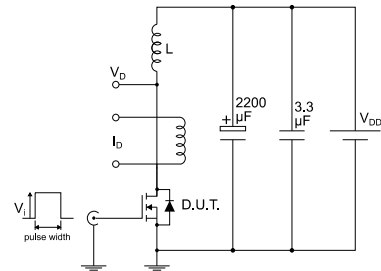

AM01471v1

Figure 19: Unclamped inductive waveform

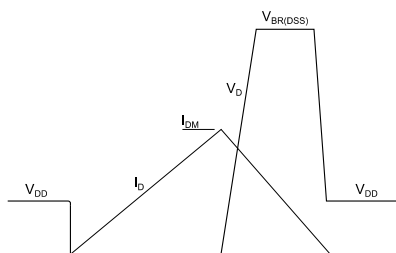

AM01472v1

Figure 20: Switching time waveform

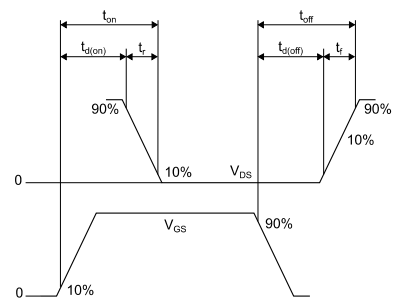

AM01473v1

4 Package information

In order to meet environmental requirements, ST offers these devices in different grades of ECOPACK® packages, depending on their level of environmental compliance. ECOPACK® specifications, grade definitions and product status are available at: www.st.com. ECOPACK® is an ST trademark.

4.1 TO-92 ammpack package information

Figure 21: TO-92 ammpack package outline

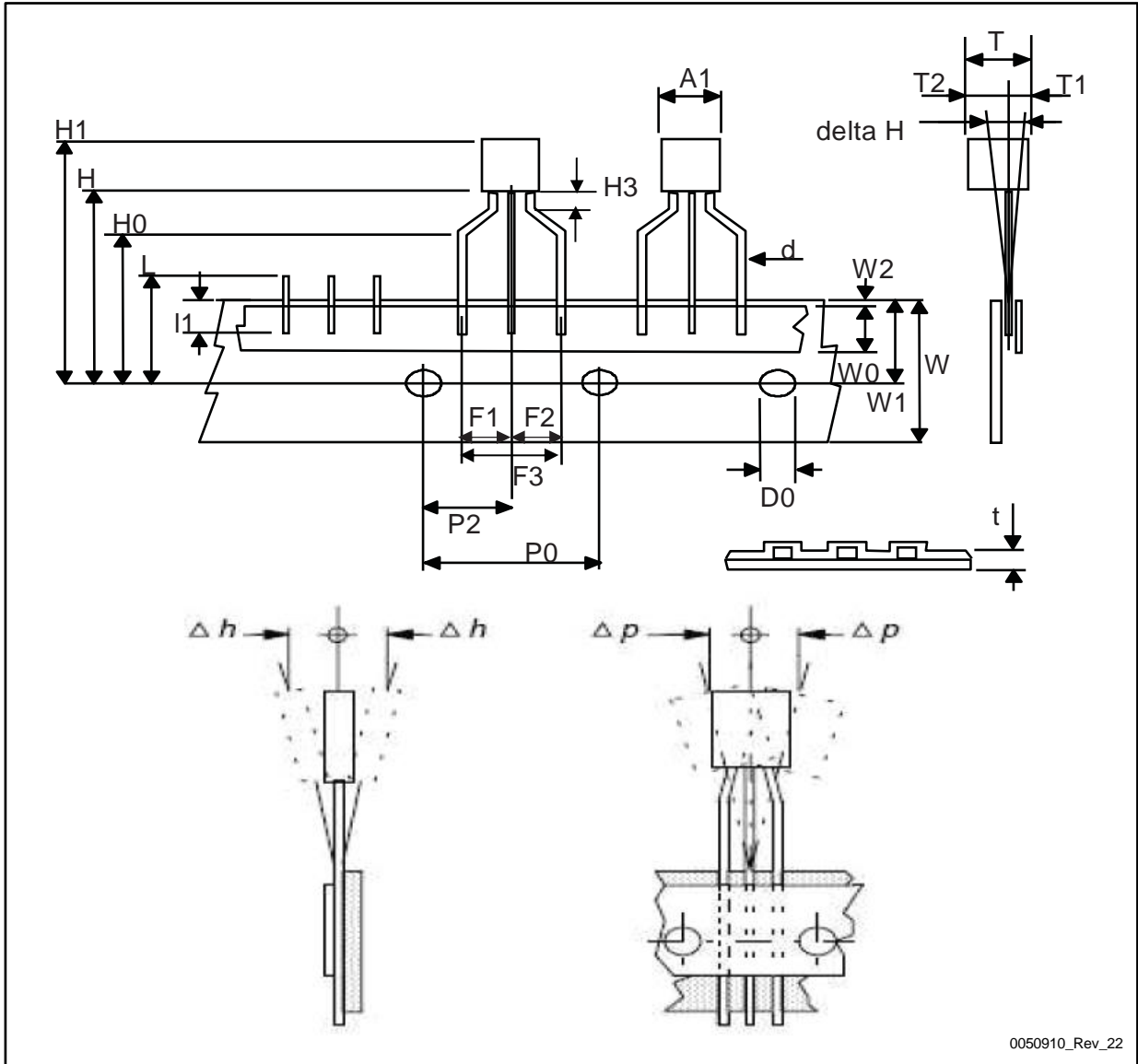

Table 10: TO-92 ammpak mechanical data

Dim.	mm		
	Min.	Typ.	Max.
A1			4.80
T			3.80
T1			1.60
T2			2.30
d	0.45	0.47	0.48
P0	12.50	12.70	12.90
P2	5.65	6.35	7.05
F1, F2	2.40	2.50	2.94
F3	4.98	5.08	5.48
delta H	-2.00		2.00
W	17.50	18.00	19.00
W0	5.50	6.00	6.50
W1	8.50	9.00	9.25
W2			0.50
H		18.50	21.00
H0	15.50	16.00	18.20
H1		25.00	27.00
H3	0.50	1.00	2.00
D0	3.80	4.00	4.20
t			0.90
L			11.00
l1	3.00		
delta P	-1.00		1.00

5 Revision history

Table 11: Document revision history

Date	Revision	Changes
19-Jul-2012	1	First release.
24-Jan-2017	2	Modified title, features and description on cover page Modified <i>Table 2: "Absolute maximum ratings"</i> , <i>Table 5: "On/off states"</i> and <i>Table 9: "Gate-source Zener diode"</i> Modified: <i>Figure 11: "Normalized on-resistance vs temperature"</i> Updated <i>Section 4.1: "TO-92 ammpack package information"</i> Minor text changes
01-Feb-2017	3	Modified <i>Figure 2: "Safe operating area"</i> . Minor text changes.

IMPORTANT NOTICE – PLEASE READ CAREFULLY

STMicroelectronics NV and its subsidiaries ("ST") reserve the right to make changes, corrections, enhancements, modifications, and improvements to ST products and/or to this document at any time without notice. Purchasers should obtain the latest relevant information on ST products before placing orders. ST products are sold pursuant to ST's terms and conditions of sale in place at the time of order acknowledgement.

Purchasers are solely responsible for the choice, selection, and use of ST products and ST assumes no liability for application assistance or the design of Purchasers' products.

No license, express or implied, to any intellectual property right is granted by ST herein.

Resale of ST products with provisions different from the information set forth herein shall void any warranty granted by ST for such product.

ST and the ST logo are trademarks of ST. All other product or service names are the property of their respective owners.

Information in this document supersedes and replaces information previously supplied in any prior versions of this document.

© 2017 STMicroelectronics – All rights reserved