

b

# ***FM Stereo FM-AM Receiver***

---

www.DataSheet4U.com

Operating Instructions

***STR-DE675  
STR-DE575  
STR-K502***

www.DataSheet4U.com

# WARNING

**To prevent fire or shock hazard, do not expose the unit to rain or moisture.**

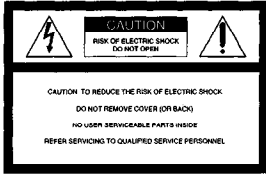

This symbol is intended to alert the user to the presence of uninsulated "dangerous voltage" within the product's enclosure that may be of sufficient magnitude to constitute a risk of electric shock to persons



This symbol is intended to alert the user to the presence of important operating and maintenance (servicing) instructions in the literature accompanying the appliance

## INFORMATION

This equipment has been tested and found to comply with the limits for a Class B digital device, pursuant to Part 15 of the FCC Rules

These limits are designed to provide reasonable protection against harmful interference in a residential installation. This equipment generates, uses, and can radiate radio frequency energy and, if not installed and used in accordance with the instructions, may cause harmful interference to radio communications. However, there is no guarantee that interference will not occur in a particular installation. If this equipment does cause harmful interference to radio or television reception, which can be determined by turning the equipment off and on, the user is encouraged to try to correct the interference by one or more of the following measures:

- Reorient or relocate the receiving antenna
- Increase the separation between the equipment and receiver
- Connect the equipment into an outlet on a circuit different from that to which the receiver is connected
- Consult the dealer or an experienced radio/TV technician for help

## CAUTION

You are cautioned that any changes or modification not expressly approved in this manual could void your authority to operate this equipment

### Note to CATV system installer:

This reminder is provided to call CATV system installer's attention to Article 820-40 of the NEC that provides guidelines for proper grounding and, in particular, specifies that the cable ground shall be connected to the grounding system of the building, as close to the point of cable entry as practical

### Owner's Record

The model and serial numbers are located on the rear of the unit. Record the serial number in the space provided below. Refer to them whenever you call upon your Sony dealer regarding this product.

Model No. STR-DE675/DE575/K502  
Serial No. \_\_\_\_\_

### For customers in Canada

## CAUTION

TO PREVENT ELECTRIC SHOCK, DO NOT USE THIS POLARIZED AC PLUG WITH AN EXTENSION CORD, RECEPTACLE OR OTHER OUTLET UNLESS THE BLADES CAN BE FULLY INSERTED TO PREVENT BLADE EXPOSURE

### For customers in the United States and Canada



ENERGY STAR® is a U.S. registered mark. As an ENERGY STAR® partner, Sony Corporation has determined that this product meets the ENERGY STAR® guidelines for energy efficiency.

# Precautions

## On safety

- Should any solid object or liquid fall into the cabinet, unplug the receiver and have it checked by qualified personnel before operating it any further
- To prevent fire, do not cover the ventilation of the receiver with newspapers, table cloths, curtains, etc. And don't place lighted candles on the receiver
- To prevent fire or shock hazards, do not place vases on the receiver

## On power sources

- Before operating the receiver, check that the operating voltage is identical with your local power supply. The operating voltage is indicated on the nameplate at the rear of the receiver
- The unit is not disconnected from the AC power source (mains) as long as it is connected to the wall outlet, even if the unit itself has been turned off
- If you are not going to use the receiver for a long time, be sure to disconnect the receiver from the wall outlet. To disconnect the AC power cord, grasp the plug itself; never pull the cord
- One blade of the plug is wider than the other for the purpose of safety and will fit into the wall outlet only one way. If you are unable to insert the plug fully into the outlet, contact your dealer
- AC power cord must be changed only at the qualified service shop

## On placement

- Place the receiver in a location with adequate ventilation to prevent heat buildup and prolong the life of the receiver
- Do not place the receiver near heat sources, or in a place subject to direct sunlight, excessive dust or mechanical shock
- Do not place anything on top of the cabinet that might block the ventilation holes and cause malfunctions
- Although the receiver heats up during operation, this is not a malfunction. If you continuously use this receiver at a large volume, the cabinet temperature of the top, side and bottom rises accordingly. To avoid burning yourself, do not touch the cabinet

## On operation

Before connecting other components, be sure to turn off and unplug the receiver

## On cleaning

Clean the cabinet, panel and controls with a soft cloth slightly moistened with a mild detergent solution. Do not use any type of abrasive pad, scouring powder or solvent such as alcohol or benzene

If you have any question or problem concerning your receiver, please consult your nearest Sony dealer

[www.DataSheet4U.com](http://www.DataSheet4U.com)

# About This Manual

The instructions in this manual are for the STR-DE675, STR-DE575 and STR-K502. Check your model number by looking at the lower right corner of the front panel or lower right corner of the remote. In this manual, the STR-DE675 and the remote commander RM-U305 are used for illustration purposes unless stated otherwise. Any difference in operation is clearly indicated in the text, for example, "STR-DE675 only"

## Type of differences

Model	DE675	DE575
CONTROL A1-II	•	
VIDEO 2	•	
MD/TAPE OPTICAL IN/OUT	•	
AC OUTLET	•	
IMPEDANCE SELECTOR	•	

## About area codes

The area code of the player you purchased is shown on the lower portion of the rear panel (see the illustration below)

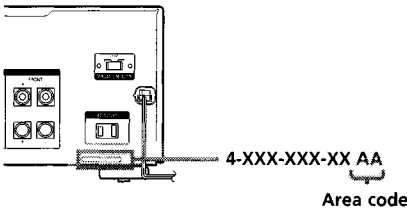

Any differences in operation, according to the area code, are clearly indicate in the text, for example, "Models of area code AA only"

## Conventions

- The instructions in this manual describe the controls on the receiver. You can also use the controls on the supplied remote if they have the same or similar names as those on the receiver.
- The following icon is used in this manual:  

 Indicates hints and tips for making the task easier.

This receiver incorporates Dolby\* Digital and Pro Logic Surround and the DTS\*\* Digital Surround System

\* Manufactured under license from Dolby Laboratories "Dolby", "AC-3", "Pro Logic" and the double-D symbol are trademarks of Dolby Laboratories Confidential unpublished Works © 1992-1997 Dolby Laboratories All rights reserved

\*\* Manufactured under license from Digital Theater Systems, Inc. US Pat. No. 5,451,942, 5,956,674, 5,974,380, 5,978,762 and other world-wide patents issued and pending "DTS" and "DTS Digital Surround" are registered trademarks of Digital Theater Systems, Inc. Copyright 1996, 2000 Digital Theater Systems, Inc. All Rights Reserved

# TABLE OF CONTENTS

## Hooking Up the Components 4

- Unpacking 4
- Antenna Hookups 5
- Audio Component Hookups 6
- Video Component Hookups 7
- Digital Component Hookups 8
- MULTI CH IN Hookups 10
- Other Hookups 11

## Hooking Up and Setting Up the Speaker System 13

- Speaker System Hookup 14
- Performing Initial Setup Operations 16
- Multi Channel Surround Setup 17
- Before You Use Your Receiver 21

## Location of Parts and Basic Operations 23

- Front Panel Parts Descriptions 23

## Enjoying Surround Sound 27

- Selecting a Sound Field 28
- Understanding the Multi-Channel Surround Displays 32
- Customizing Sound Fields 34

## Receiving Broadcasts 38

- Direct Tuning 40
- Automatic Tuning 40
- Preset Tuning 41

## Other Operations 42

- Naming Preset Stations and Program Sources 43
- Recording 43
- Using the Sleep Timer 44
- Adjustment Using the SET UP Button 45
- CONTROL A1II Control System (STR-DE675 only) 45

## Additional Information 47

- Troubleshooting 47
- Specifications 49
- Glossary 51
- Settings Using SURR, LEVEL, EQ, and SET UP buttons 52
- Remote Button Description 53
- Index 61

# Hooking Up the Components

This chapter describes how to connect various audio and video components to the receiver. Be sure to read the sections for the components you have before you actually connect them to the receiver.

## Unpacking

Check that you received the following items with the receiver:

- FM wire antenna (1)
- AM loop antenna (1)
- R6 (size-AA) batteries (2)
- STR-DE675 only
  - Remote commander RM-PP505 (remote) (1)
- STR-DE575 only
  - Model of area code U only
    - Remote commander RM-U305 (remote) (1)
  - Model of area code CA only
    - Remote commander RM-PP505 (remote) (1)
- STR-K502 only
  - Remote commander RM-U305 (remote) (1)

### Inserting batteries into the remote

Insert R6 (size-AA) batteries with the + and – properly oriented in the battery compartment. When using the remote, point it at the remote sensor on the receiver.

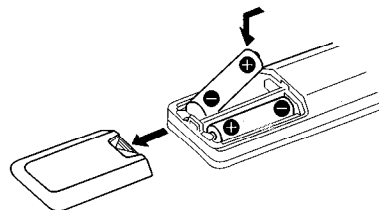

### 💡 When to replace batteries

Under normal conditions, the batteries should last for about 6 months. When the remote no longer operates the receiver, replace all batteries with new ones.

### Notes

- Do not leave the remote in an extremely hot or humid place.
- Do not use a new battery with an old one.
- Do not expose the remote sensor to direct sunlight or lighting apparatuses. Doing so may cause a malfunction.
- If you don't use the remote for an extended period of time, remove the batteries to avoid possible damage from battery leakage and corrosion.

### Before you get started

- Turn off the power to all components before making any connections.
- Do not connect the AC power cords until all of the connections are completed.
- Be sure to make connections firmly to avoid hum and noise.
- When connecting an audio/video cord, be sure to match the color-coded pins to the appropriate jacks on the components: yellow (video) to yellow; white (left, audio) to white; and red (right, audio) to red.

# Antenna Hookups

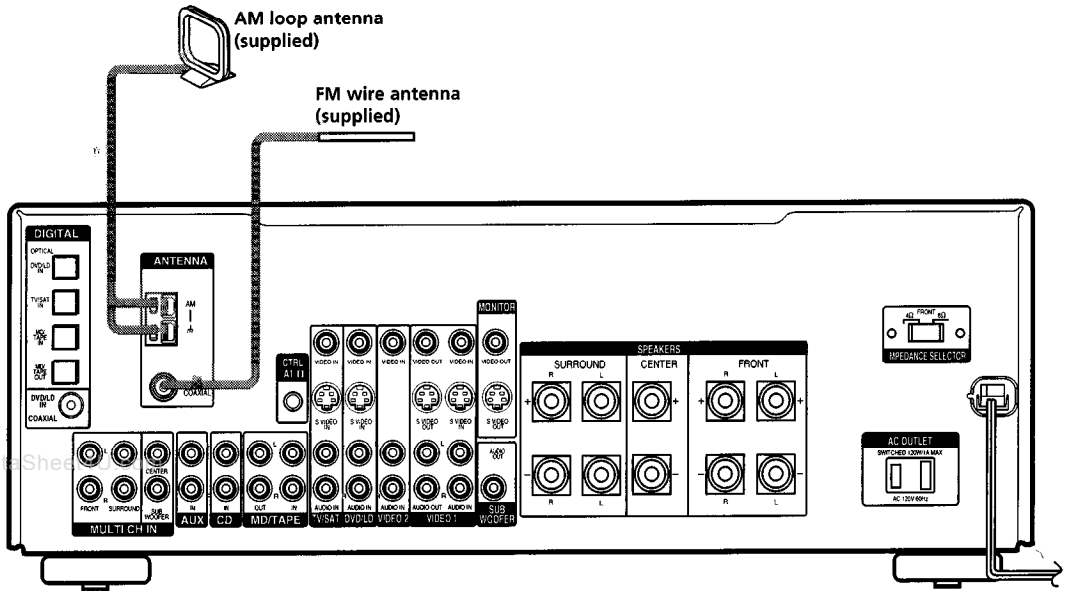

## Terminals for connecting the antennas

Connect the	To the
AM loop antenna	AM terminals
FM wire antenna	FM 75Ω COAXIAL terminal

## Notes on antenna hookups

- To prevent noise pickup, keep the AM loop antenna away from the receiver and other components
- Be sure to fully extend the FM wire antenna
- After connecting the FM wire antenna, keep it as horizontal as possible

## 💡 If you have poor FM reception

Use a 75-ohm coaxial cable (not supplied) to connect the receiver to an outdoor FM antenna as shown below

### Outdoor FM antenna

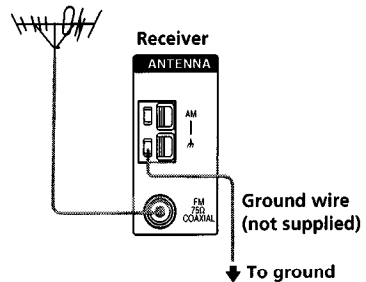

## Important

If you connect the receiver to an outdoor antenna, ground it against lightning. To prevent a gas explosion, do not connect the ground wire to a gas pipe

# Audio Component Hookups

Hooking Up the Components

## Required cords

Audio cords (not supplied)

When connecting a cord, be sure to match the color-coded pins to the appropriate jacks on the components

White (L)

White (L)

Red (R)

Red (R)

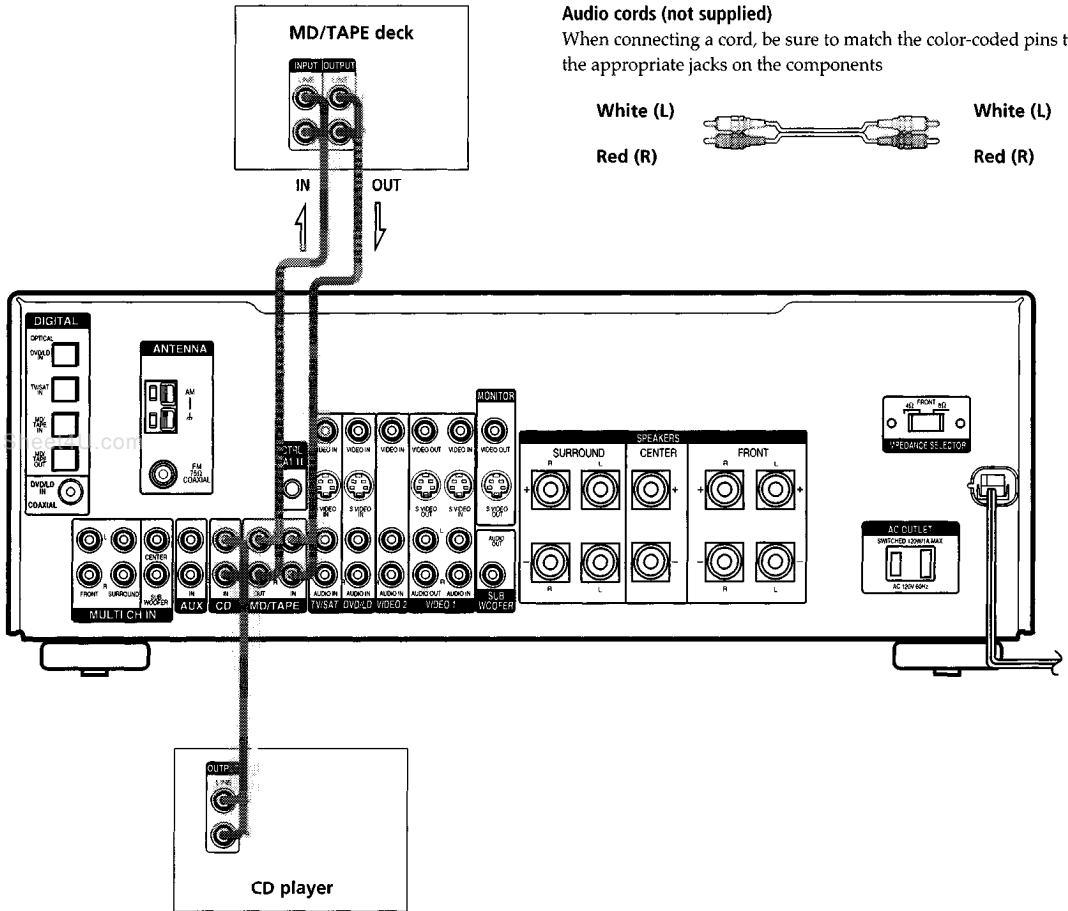

## Jacks for connecting audio components

Connect a	To the
CD player	CD jacks
MD deck or Tape deck	MD/TAPE jacks

# Video Component Hookups

## Required cords

### Audio/video cords (not supplied)

When connecting a cord, be sure to match the color-coded pins to the appropriate jacks on the components

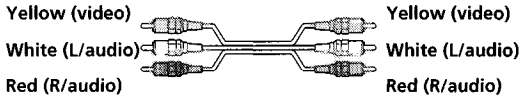

### Video cord for connecting a TV monitor (not supplied)

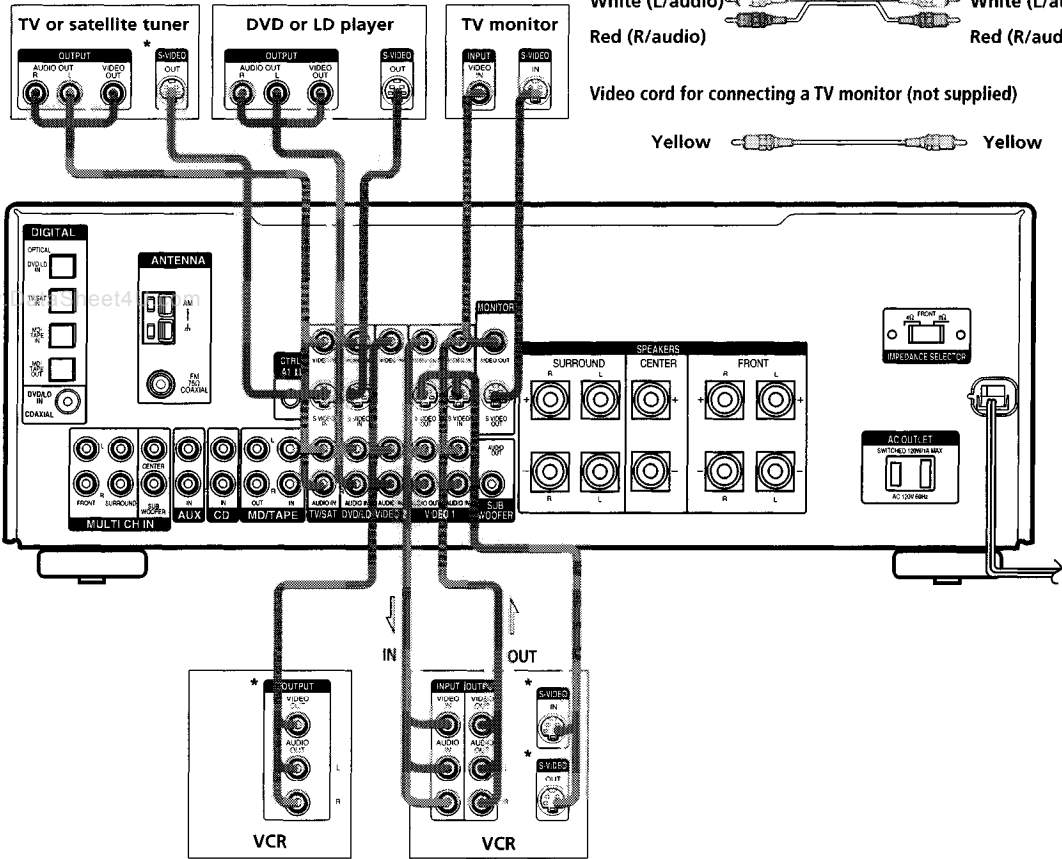

\* STR-DE675 only

## Jacks for connecting video components

Connect a	To the
TV or satellite tuner	TV/SAT jacks
VCR	VIDEO 1 jacks
*Additional VCR	VIDEO 2 jacks
DVD or LD player	DVD/LD jacks
TV monitor	MONITOR VIDEO OUT jack

\* STR-DE675 only

## Note on video component hookups

You can connect your TV's audio output jacks to the TV / SAT AUDIO IN jacks on the receiver and apply sound effects to the audio from the TV. In this case, do not connect the TV's video output jack to the TV/SAT VIDEO IN jack on the receiver. If you are connecting a separate TV tuner (or satellite tuner), connect both the audio and video output jacks to the receiver as shown above.

### 💡 When using the S-video jacks instead of the video jacks

Your monitor must also be connected via an S-video jack. S-video signals are on a separate bus from the video signals and will not be output through the video jacks.

# Digital Component Hookups

Connect the digital output jacks of your DVD player and satellite tuner (etc) to the receiver's digital input jacks to bring the multi channel surround sound of a movie theater into your home. To enjoy full effect of multi channel surround sound, five speakers (two front speakers, two surround speakers, and a center speaker) and a sub woofer are required. You can also connect an LD player with an RF OUT jack via an RF demodulator, such as the Sony MOD-RF1 (not supplied)

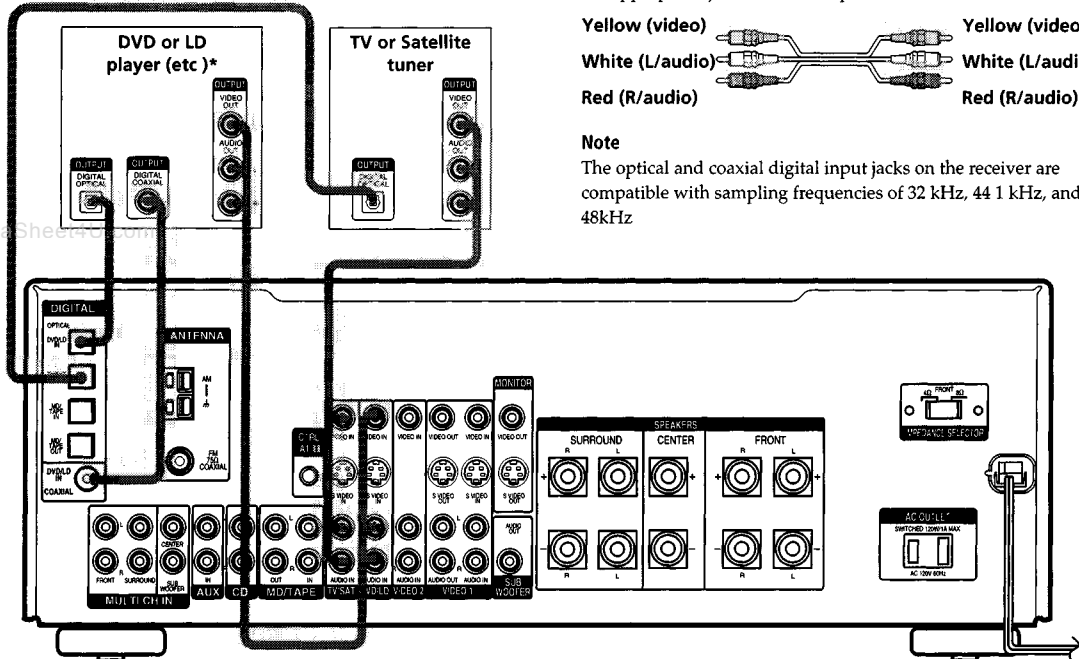

\* When making digital audio connections to a DVD player, connect to either the coaxial OR optical digital jacks, and not both. It is recommended to make digital audio connections to the coaxial jack.

## Required cords

Optical digital cords (not supplied)

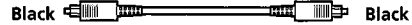

Coaxial digital cord (not supplied)



Audio/video cords (not supplied)

When connecting a cord, be sure to match the color-coded pins to the appropriate jacks on the components

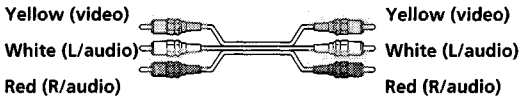

### Note

The optical and coaxial digital input jacks on the receiver are compatible with sampling frequencies of 32 kHz, 44.1 kHz, and 48kHz

## Example of LD player connected via an RF demodulator

Please note that you cannot connect an LD player's AC-3 RF OUT jack directly to the receiver's digital input jacks. You must first convert the RF signal to either an optical or coaxial digital signal. Connect the LD player to the RF demodulator, then connect the RF demodulator's optical or coaxial digital output to the receiver's OPTICAL or COAXIAL DVD/LD IN jack. Refer to the instruction manual supplied with your RF Demodulator for details on AC-3 RF hookups.

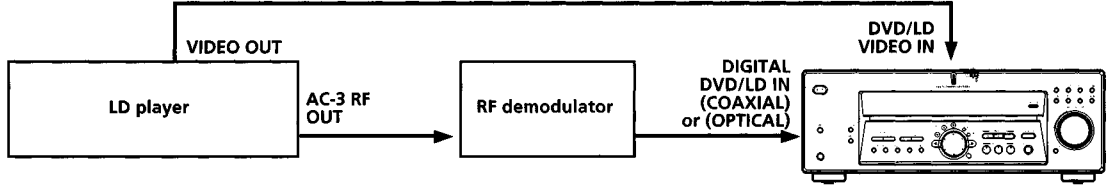

### Note

When making connections as shown above, be sure to set INPUT MODE (B) on page 25) manually. The receiver may not operate correctly if INPUT MODE is set to "AUTO"



**STR-DE675 only**

Connect the digital output jacks of your MD or tape deck to the receiver's digital input jack and connect the digital input jacks of your MD or tape deck to the receiver's digital output jack. These connections allow you to make digital recordings of a CDs played back through your DVD (or LD player) and satellite broadcasts

**Required cords**

Optical digital cords (not supplied)

Black  Black

Audio cords (not supplied)

When connecting a cord, be sure to match the color-coded pins to the appropriate jacks on the components

White (L)  White (L)  
 Red (R)  Red (R)

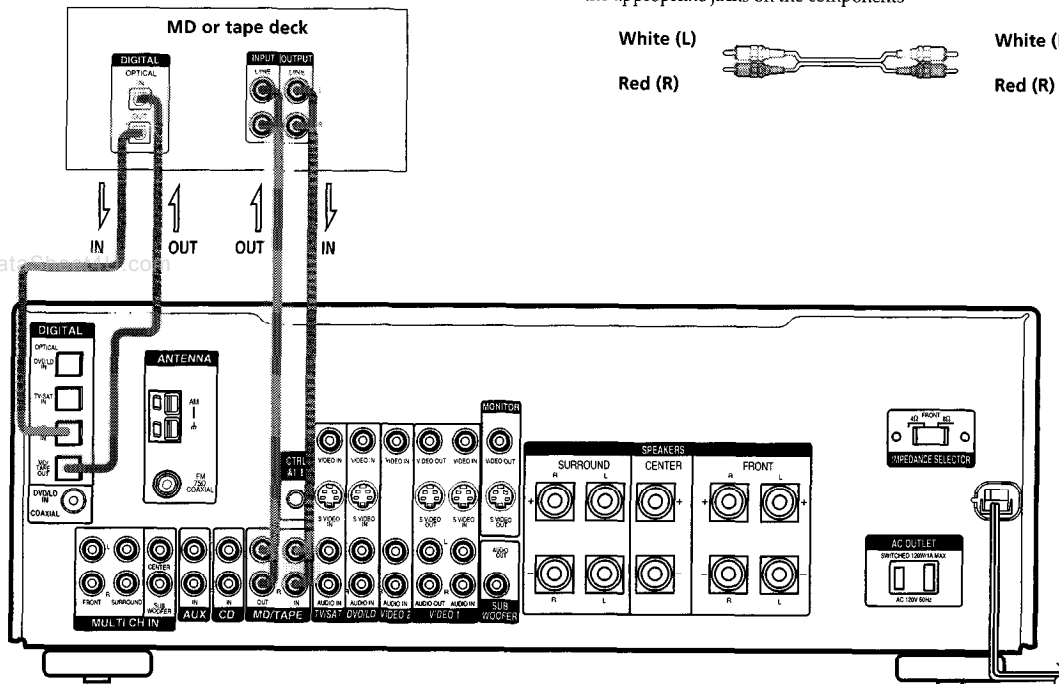

**Notes**

- Please note that you cannot make a digital recording of a digital multi channel surround signal
- To make a digital recording from your CD player, connect the CD player's digital output directly to the digital input on your MD or tape deck. Refer to the instructions supplied with your CD player and MD or tape deck for details
- The DVD/LD IN OPTICAL and COAXIAL jacks are compatible with 96 kHz, 48 kHz, 44.1 kHz and 32 kHz sampling frequencies. The other OPTICAL jacks are compatible with 48 kHz, 44.1 kHz and 32 kHz sampling frequencies
- It is not possible to record analog signals to TAPE and VIDEO with only digital connections. To record analog signals, make analog connections. To record digital signals, make digital connections
- Input signals with 96 kHz sampling frequencies to the DVD/LD IN OPTICAL or COAXIAL jacks. Using other jacks may result in intermittent sound

# MULTI CH IN Hookups

Hooking Up the Components

Although this receiver incorporates a multi channel decoder, it is also equipped with MULTI CH IN jacks. These connections allow you to enjoy multichannel software encoded in formats other than Dolby Digital (AC-3) and DTS. If your DVD player is equipped with MULTI CH OUTPUT jacks, you can connect them directly to the receiver to enjoy the sound of the DVD player's multi channel decoder. Alternatively, the MULTI CH IN jacks can be used to connect an external multi channel decoder.

To fully enjoy multi channel surround sound, you will need five speakers (two front speakers, two surround speakers, and a center speaker) and a sub woofer. Refer to the instruction manual supplied with your DVD player, multi channel decoder, etc., for details on the multi channel input hookups.

## Required cords

### Audio cords (not supplied)

Two for the MULTI CH IN FRONT and SURROUND jacks



### Monaural audio cords (not supplied)

Two for the MULTI CH IN CENTER and SUB WOOFER jacks

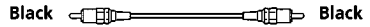

### Video cord (not supplied)

One for the DVD/LD VIDEO IN jacks (etc.)



### Note

When using the connections described below, adjust the level of your surround speakers and sub woofer from the DVD player or multichannel decoder.

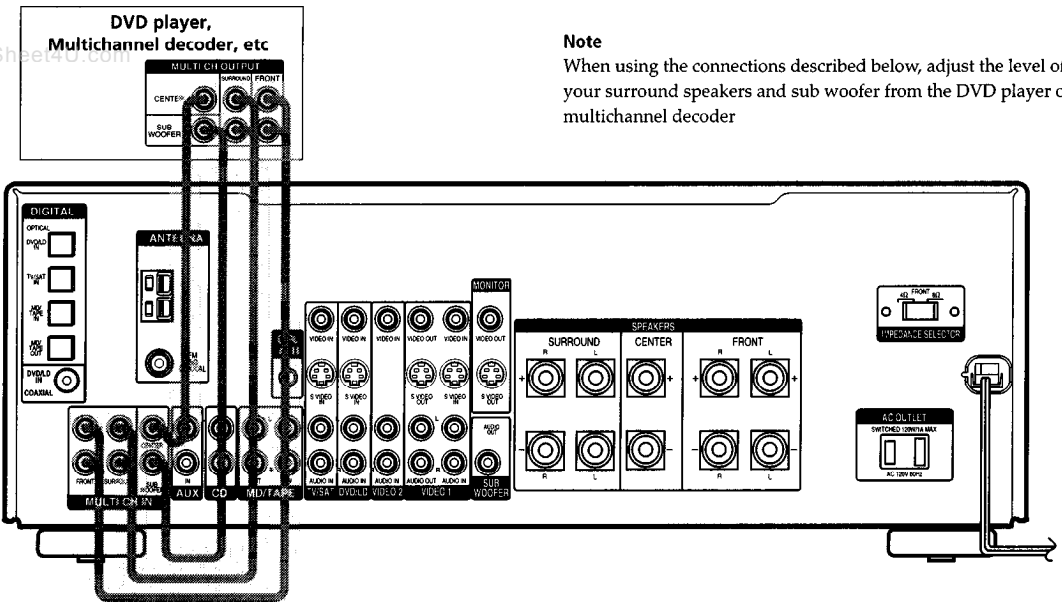

## Example of a DVD player hookup using the MULTI CH IN jacks

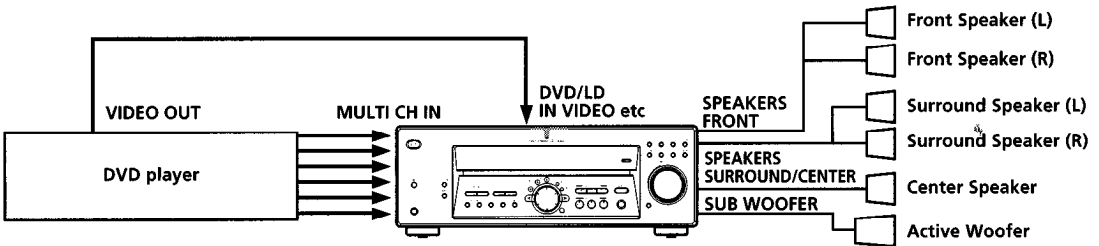

### Note

See page 14 for details on speaker system hookup

# Other Hookups

## Required cords

### Audio cords (not supplied)

When connecting a cord, be sure to match the color-coded pins to the appropriate jacks on the components



### Control A1 connecting cord (not supplied) (STR-DE675 only)

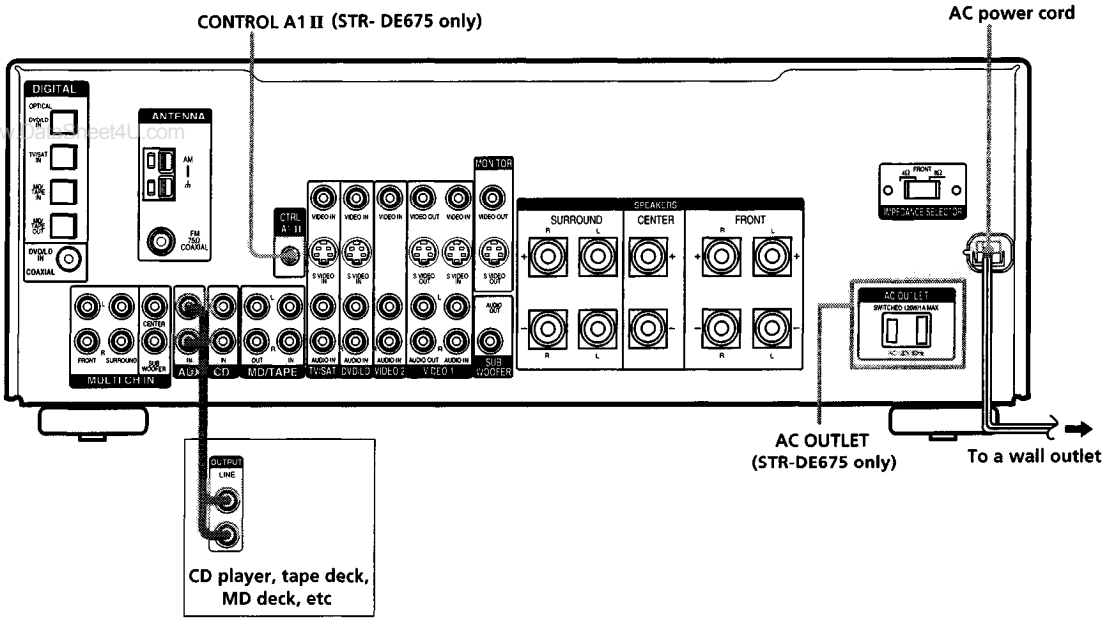

### CONTROL A1 II hookup (STR-DE675 only)

- **If you have a CONTROL A1 II compatible Sony CD player, tape deck, or MD deck**

Use a CONTROL A1 cord (not supplied) to connect the CONTROL A1 II jack on the CD player, tape deck, or MD deck to the CONTROL A1 II jack on the receiver. Refer "CONTROL-A1 II Control System" on page 45 and the operating instructions supplied with your CD player, tape deck, or MD deck for details.

**Note**

If you make CONTROL A1 II connections from the receiver to an MD deck that is also connected to a computer, do not operate the receiver while using the "Sony MD Editor" software. This may cause a malfunction.

- **If you have a Sony CD changer with a COMMAND MODE selector**

If your CD changer's COMMAND MODE selector can be set to CD 1, CD 2, or CD 3, be sure to set the command mode to "CD 1" and connect the changer to the CD jacks on the receiver.

If, however, you have a Sony CD changer with VIDEO OUT jacks, set the command mode to "CD 2" and connect the changer to the VIDEO IN jacks on the receiver.

### AUX AUDIO IN hookup

- **If you have an individual audio component (except PHONO)**

Use the audio cords to connect the LINE OUT jacks on the CD player, tape deck, or MD deck to the AUX AUDIO IN jack on the receiver so that you can listen to stereo sources in surround sound.

### Connecting the AC power cord

Before connecting the AC power cord of this receiver to a wall outlet:

- Connect the speaker system to the receiver (see page 14).

Connect the AC power cord(s) of your audio/video components to a wall outlet.

#### STR-DE675 only

If you connect other audio/video components to the AC OUTLET(s) on the receiver, the receiver will supply power to the connected component(s), allowing you to turn the whole system on or off when you turn the receiver on or off.

**Caution**

Make sure that the total power consumption of the component(s) connected to the receiver's AC OUTLET(s) does not exceed the wattage stated on the rear panel. Do not connect high-wattage electrical home appliances such as electric irons, fans, or TVs to this outlet (STR-DE675 only).

**Note**

If the AC power cord is disconnected for about one week, the receiver's entire memory will be cleared and the demonstration will start.

# Hooking Up and Setting Up the Speaker System

This chapter describes how to hook up your speaker system to the receiver, how to position each speaker, and how to set up your speakers to enjoy multi channel surround sound.

[www.DataSheet4U.com](http://www.DataSheet4U.com)

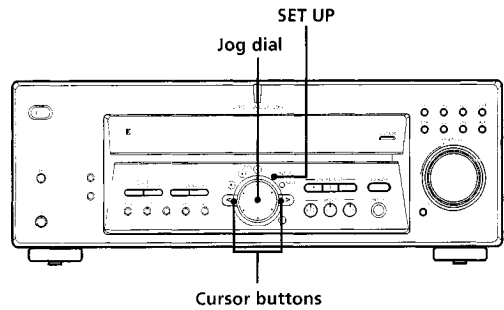

## Brief descriptions of buttons and control used to set up the speaker system

**SET UP button:** Press to enter the setup mode when specifying speaker types and distances

**Cursor buttons (</>):** Use to select parameters after pressing the SET UP button

**Jog dial:** Use to adjust the setting of each parameter

# Speaker System Hookup

## Required cords

### Speaker cords (not supplied)

One for each front, surround, and center speaker



### Monaural audio cord (not supplied)

One for an active woofer

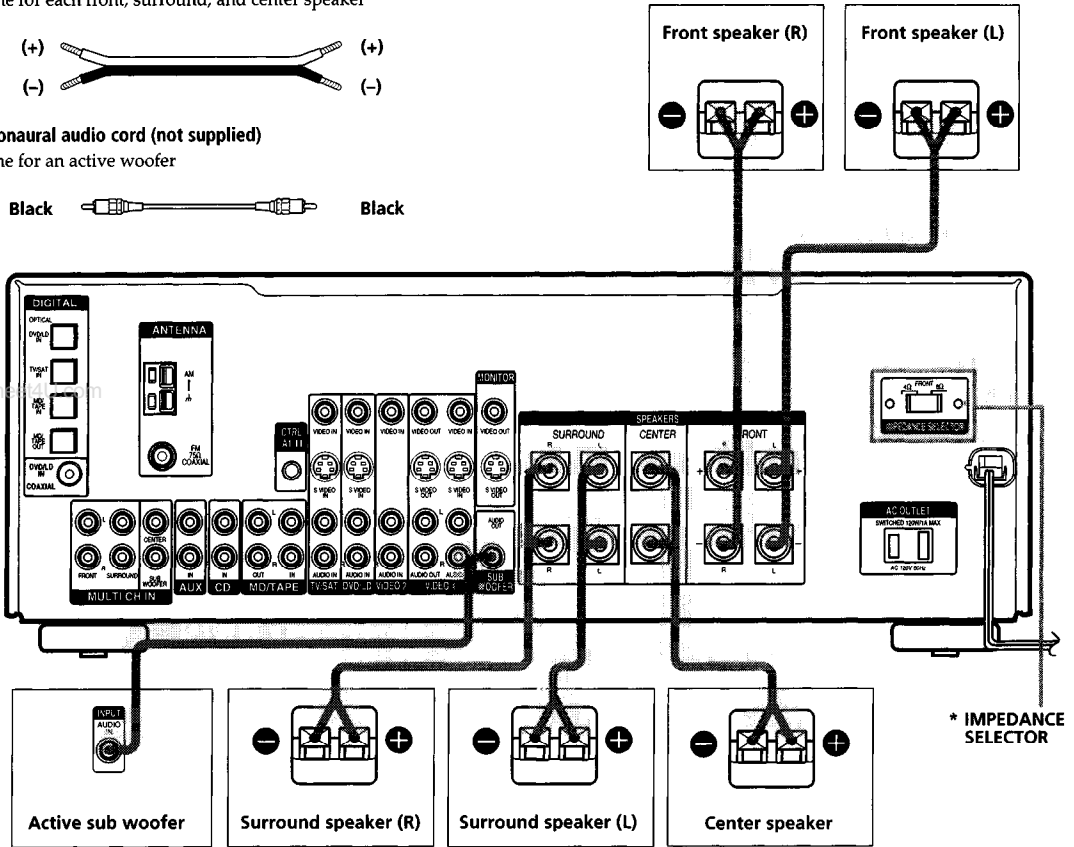
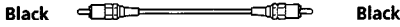

\* IMPEDANCE SELECTOR

## Terminals for connecting the speakers

Connect the	To the
Front speakers (8 or 4* ohm)	SPEAKERS FRONT terminals
Surround speakers (8 ohm)	SPEAKERS SURROUND terminals
Center speaker (8 ohm)	SPEAKERS CENTER terminals
Active sub woofer	SUB WOOFER AUDIO OUT jack

\* STR-DE675 only

See "Speaker impedance" on the next page

## Notes on speaker system hookup

- Twist the stripped ends of the speaker cords about 2/3 inch (10 mm). Be sure to match the speaker cord to the appropriate terminal on the components: + to + and - to -. If the cords are reversed, the sound will be distorted and will lack bass.
- If you use speakers with low maximum input rating, adjust the volume carefully to avoid excessive output on the speakers.

Hooking Up and Setting Up the Speaker System

## Speaker System Hookup

### To avoid short-circuiting the speakers

Short-circuiting of the speakers may damage the receiver. To prevent this, make sure to take the following precautions when connecting the speakers.

**Make sure the stripped ends of each speaker cord does not touch another speaker terminal or the stripped end of another speaker cord.**

### Examples of poor conditions of the speaker cord

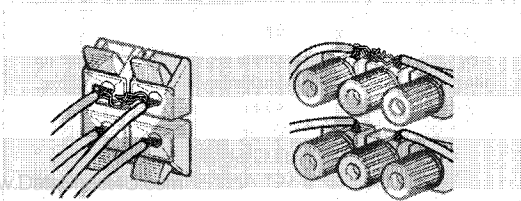

Stripped speaker cord is touching another speaker terminal

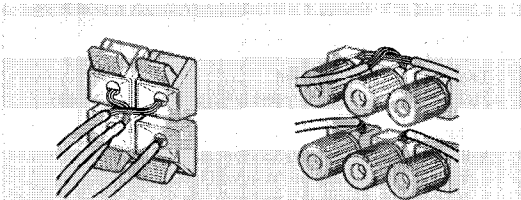

Stripped cords are touching each other due to excessive removal of insulation

**After connecting all the components, speakers, and AC power cord, output a test tone to check that all the speakers are connected correctly. For details on outputting a test tone, see page 20.**

If no sound is heard from a speaker while outputting a test tone or a test tone is output from a speaker other than the one whose name is currently displayed on the receiver, the speaker may be short-circuited. If this happens, check the speaker connection again.

### To avoid damaging your speakers

Make sure that you turn down the volume before you turn off the receiver. When you turn on the receiver, the volume remains at the level you turn off the receiver.

### Speaker impedance (STR-DE675 only)

Set the IMPEDANCE SELECTOR for the front speakers as indicated in the table below. Check the instruction manual supplied with your speakers if you're not sure of their impedance. (This information is usually printed on a label on the back of the speaker.)

If the nominal impedance of your speaker is	Set IMPEDANCE SELECTOR to
Between 4 and 8 ohms	4Ω
8 ohms or higher	8Ω

Speakers connected to the SURROUND and CENTER SPEAKERS terminals must have a nominal impedance of 8 ohms or higher (regardless of the setting of the IMPEDANCE SELECTOR).

# Performing Initial Setup Operations

Once you have hooked up the speakers and turned on the power, clear the receiver's memory. Then specify the speaker parameters (size, position, etc.) and perform any other initial setup operations necessary for your system.

## Clearing the receiver's memory

Before you use your receiver for the first time or when you want to clear the receiver's memory, do the following. This procedure is not necessary if the demonstration activates when you turn the power on.

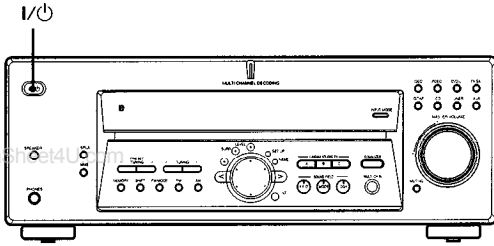

**1 Turn off the receiver.**

**2 Hold down I/O for four seconds**

The currently selected function, then the demonstration message appears in the display and the items including the following are reset or cleared:

- All preset stations are reset or cleared
- All sound field parameters are reset to their factory settings
- All index names (of preset stations and program sources) are cleared
- All adjustments made with the SET UP button are reset to their factory settings
- The sound field memorized for each program source and preset stations are cleared

## Performing initial setup operations

Before you use your receiver for the first time, use the SET UP button to adjust settings to correspond to your system. You can set the following items. For details on how to adjust each setting, see the page in parentheses.

- Speaker size and placement (page 17)
- Speaker distance (page 19)
- Select the MULTI CH IN video signal (page 45)
- Whether the display turns off or not when you press DIMMER (page 45)

### Demonstration Mode

The demonstration will activate the first time you turn on the power. When the demonstration starts, the following message appears in the display:

“NOW DEMONSTRATION MODE IF YOU FINISH DEMONSTRATION PLEASE PRESS POWER KEY WHILE THIS MESSAGE APPEARS IN THE DISPLAY THANK YOU”

#### To cancel the demonstration

Press I/O to turn the receiver off while the above message is being displayed. The next time you turn the receiver on, the demonstration will not appear.

#### To view the demonstration

Hold down SET UP and press I/O to turn on the power.

#### Notes

- Running the demonstration will clear the receiver's memory. For details on what will be cleared, see “Clearing the receiver's memory” on this page.
- There will be no sound when the demonstration mode is activated.
- You cannot cancel demonstration if you did not press I/O while the above message is being displayed. To cancel demonstration after the above message appears, press I/O twice to activate the demonstration again. Then, press I/O while the above message is being displayed.

Hooking Up and Setting Up the Speaker System



# Multi Channel Surround Setup

For the best possible surround sound all speakers should be the same distance from the listening position (A) (However, this unit lets you to place the center speaker up to 5 feet (1.5 meters) closer (B) and the surround speakers up to 15 feet (4.5 meters) closer (C) to the listening position. The front speakers can be placed from 3 to 40 feet (1.0 to 12.0 meters) from the listening position (A))

You can place the surround speakers either behind you or to the side, depending on the shape of your room (etc)

When placing surround speakers to your side

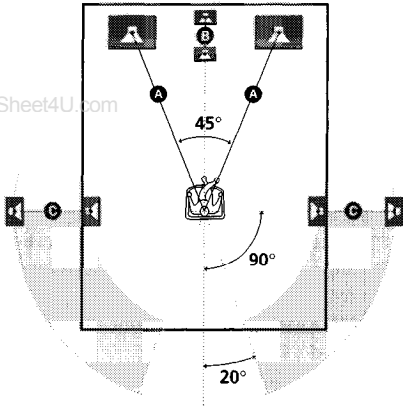

When placing the surround speakers behind you

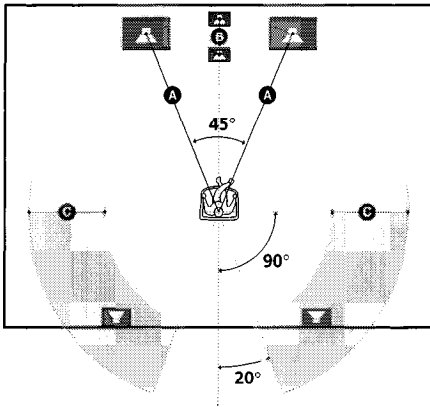

## Note

Do not place the center speaker farther away from the listening position than the front speakers

## Specifying the speaker parameters

- 1 Press I/⏻ to turn on the receiver.
- 2 Press SET UP.
- 3 Press the cursor buttons (< or >) to select the parameter you want to adjust
- 4 Turn the jog dial to select the setting you want. The setting is stored automatically
- 5 Repeat steps 3 and 4 until you have set all of the parameters that follow

### 💡 Normal speaker and Micro Satellite speaker

Choose NORM SP if you're using normal speakers and MICRO SP if you're using Micro Satellite speakers. If you choose NORM SP, you can adjust the speaker size and the sub woofer selection as mentioned below. However, if you choose MICRO SP, the speaker size and the sub woofer selection has been configured as follows:

Speakers	Settings
Front	SMALL
Center	SMALL
Surround	SMALL
Woofer	YES

You cannot change the configuration if you choose MICRO SP.

For STR-K502, the speaker size and sub woofer selection has been preset to MICRO SP according to the supplied speaker system. If you change the speaker system, choose NORM SP to adjust the speaker size and sub woofer selection.

The setting for Micro Satellite speaker (MICRO SP) has been programmed to optimize the sound balance. If you use Sony's Micro Satellite speakers, select MICRO SP. When you use Micro Satellite speaker and the speaker size is set to LARGE, you may not obtain the correct soundstage. The speaker may also be damaged at high volume position.

For STR-DE675 / DE575, the speaker size and sub woofer selection has been preset to NORM SP.

The following speaker size setup is applicable for NORM SP.

## Multi Channel Surround Setup

### ■ Front speaker size ( )

Initial setting : LARGE

- If you connect large speakers that will effectively reproduce bass frequencies, select "LARGE" Normally, select "LARGE"
- If the sound is distorted, or you feel a lack of surround effects when using multi channel surround sound, select "SMALL" to activate the bass redirection circuitry and output the front channel bass frequencies from the sub woofer
- When the front speaker is set to "SMALL", the center and surround speakers are also automatically set to "SMALL" (unless previously set to "NO")

### ■ Center speaker size ( )

Initial setting : LARGE

- If you connect a large speaker that will effectively reproduce bass frequencies, select "LARGE" Normally, select "LARGE" However, if the front speakers are set to "SMALL", you cannot set the center speaker to "LARGE"
- If the sound is distorted, or you feel a lack of surround effects when using multi channel surround sound, select "SMALL" to activate the bass redirection circuitry and output the center channel bass frequencies from the front speakers (if set to "LARGE") or sub woofer \*1
- If you do not connect the center speaker, select "NO" The sound of the center channel will be output from the front speakers \*2

### ■ Surround speaker size ( )

Initial setting : LARGE

- If you connect large speakers that will effectively reproduce bass frequencies, select "LARGE" Normally, select "LARGE" However, if the front speakers are set to "SMALL", you cannot set the surround speakers to "LARGE"
- If the sound is distorted, or you feel a lack of surround effects when using multi channel surround sound, select "SMALL" to activate the bass redirection circuitry and output the surround channel bass frequencies from the sub woofer or other "LARGE" speakers
- If you do not connect surround speakers, select "NO" \*3

 \*1- \*3 correspond to the following Dolby Pro Logic modes

- \*1 NORMAL
- \*2 PHANTOM
- \*3 3 STEREO

### About speaker sizes (LARGE and SMALL)

Internally, the LARGE and SMALL settings for each speaker determine whether or not the internal sound processor will cut the bass signal from that channel When the bass is cut from a channel the bass redirection circuitry sends the corresponding bass frequencies to the sub woofer or other "LARGE" speaker However, since bass sounds have a certain amount of directionality it best not to cut them, if possible Therefore, even when using small speakers, you can set them to "LARGE" if you want to output the bass frequencies from that speaker On the other hand, if you are using a large speaker, but prefer not to have bass frequencies output from that speaker, set it to "SMALL"

If the overall sound level is lower than you prefer, set all speakers to "LARGE" If there is not enough bass, you can use the equalizer to boost the bass levels To adjust the equalizer see page 36

### ■ Surround speaker position ( )\*

Initial setting : PL BEHD

This parameter lets you specify the location of your surround speakers for proper implementation of the Digital Cinema Sound surround modes in the "VIRTUAL" sound fields Refer to the illustration below

- Select "PL SIDE" if the location of your surround speakers corresponds to section **A**
- Select "PL MID" if the location of your surround speakers corresponds to section **B**
- Select "PL BEHD" if the location of your surround speakers corresponds to section **C**

This setting only effects the surround modes in the "VIRTUAL" sound fields

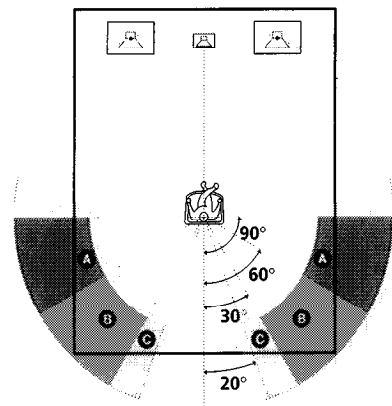

\* These parameters are not available when "Surround speaker size" is set to "NO"

### ■ Surround speaker height ( )\*

Initial setting : HGT LOW

This parameter lets you specify the height of your surround speakers for proper implementation of the Digital Cinema Sound surround modes in the “VIRTUAL” sound fields Refer to the illustration below

- Select “HGT LOW” if the location of your surround speakers corresponds to section **A**
- Select “HGT HIGH” if the location of your surround speakers corresponds to section **B**

This setting only affects the surround modes in the “VIRTUAL” sound fields

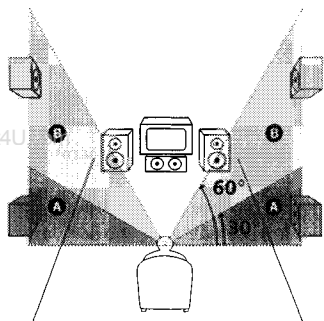

\* These parameters are not available when “Surround speaker size” is set to “NO”

### About the surround speaker position (PL SIDE, PL MID and PL BEHD)

This setting is designed specifically for implementation of the Digital Cinema Sound modes in the “VIRTUAL” sound fields. With the Digital Cinema Sound modes, speaker position is not as critical as other modes. All of the modes in the “VIRTUAL” sound fields were designed under the premise that the surround speaker would be located behind the listening position, but presentation remains fairly consistent even with the surround speakers positioned at a rather wide angle. However, if the speakers are pointing toward the listener from the immediate left and right of the listening position, the “VIRTUAL” sound fields will not be effective unless the surround speaker position parameter is set to “PL SIDE”.

Nevertheless, each listening environment has many variables, such as wall reflections, and you may obtain better results using “PL BEHD” or “PL MID” if your speakers are located high above the listening position, even if they are to the immediate left and right.

Therefore, although it may result in a setting contrary to the “Surround speaker position” explanation, we recommend that you play back multi channel surround encoded software and listen to the effect each setting has on your listening environment. Choose the setting that provides a good sense of spaciousness and that best succeeds in forming a cohesive space between the surround sound from the surround speakers and the sound from the front speakers. If you are not sure which sounds best, select “PL BEHD” and then use the speaker distance parameter and speaker level adjustments to obtain proper balance.

### ■ Sub woofer selection

Initial setting : S W YES

- If you connect a sub woofer, select “S W YES”
- If you do not connect a sub woofer, select “S W NO”  
This activates the bass redirection circuitry and outputs the LFE signals from other speakers
- In order to take full advantage of the Dolby Digital (AC-3) bass redirection circuitry, we recommend setting the sub woofer’s cut off frequency as high as possible

### ■ Front speaker distance ( )

Initial setting : DIST 5 0 m (5 0 meter) 16 feet

Set the distance from your listening position to the front (left or right) speaker (**A** on page 17)

- Front speaker distance can be set in 1 foot (0 1 meter) steps from 3 to 40 feet (1 0 to 12 0 meters)
- If both speakers are not placed an equal distance from your listening position, set the distance to the closest speaker

### ■ Center speaker distance ( )

Initial setting : DIST 5 0 m (5 0 meter) 16 feet

Set the distance from your listening position to the center speaker

- Center speaker distance can be set in 1 foot (0 1 meter) steps from a distance equal to the front speaker distance (**A** on page 17) to a distance 5 feet (1 5 meters) closer to your listening position (**B** on page 17)
- Do not place the center speaker farther away from your listening position than the front speakers

### ■ Surround speaker distance ( )

Initial setting : DIST 3 5 m (3 5 meter) 11 feet

Set the distance from your listening position to the surround (left or right) speaker

- Surround speaker distance can be set in 1 foot (0 1 meter) steps from a distance equal to the front speaker distance (**A** on page 17) to a distance 15 feet (4 5 meters) closer to your listening position (**C** on page 17)
- Do not place the surround speakers farther away from your listening position than the front speakers
- If both speakers are not placed an equal distance from your listening position, set the distance to the closest speaker

### About speaker distances

This receiver allows you to input the speaker position in terms of distance. However, it is not possible to set the center speaker farther away than the front speakers. Also, the center speaker can not be set more than 5 feet (1.5 meters) closer than the front speakers.

Likewise, the surround speakers cannot be set farther away from the listening position than the front speakers. And they can be no more than 15 feet (4.5 meters) closer.

This is because incorrect speaker placement is not conducive to enjoy the surround sound.

Please note that, setting the speaker distance closer than the actual location of the speakers will cause a delay in the output of the sound from that speaker. In other words, the speaker will sound like it is farther away.

For example, setting the center speaker distance 3~6 feet (1~2 m) closer than the actual speaker position will create a fairly realistic sensation of being "inside" the screen. If you cannot obtain a satisfactory surround effect because the surround speakers are too close, setting the surround speaker distance closer (shorter) than the actual distance will create a larger soundstage (1 foot corresponds to a 1 ms difference.)

Adjusting these parameters while listening to the sound often results in much better surround sound. Give it a try!

### Adjusting the speaker volume

Use the remote while seated in your listening position to adjust the volume of each speaker.

#### Note

This receiver incorporates a new test tone with a frequency centered at 800 Hz for easier speaker volume adjustment.

- 1 Press I/⏻ to turn on the receiver.**
- 2 Press TEST TONE on the supplied remote.**  
You will hear the test tone from each speaker in sequence.
- 3 Adjust the volume level so that the volume of the test tone from each speaker sounds the same when you are in your main listening position.**
  - To adjust the balance of the front right and front left speakers, use the front balance parameter in the LEVEL menu (see page 35).
  - To adjust the balance of the surround right and surround left speakers, use the surround balance parameter in the LEVEL menu (see page 35).
  - To adjust the volume level of the center speaker, press MENU </> to select the center parameter. Use +/- on the remote to adjust the level.
  - To adjust the volume level of the surround speaker, press MENU </> to select the surround parameter. Use +/- on the remote to adjust the level.
- 4 Press TEST TONE on the remote again to turn off the test tone.**

#### Note

The test tone cannot be output when the receiver is set to MULTI CH IN.

 **You can adjust the volume level of all speakers at the same time.**

Rotate MASTER VOLUME on the receiver or press MASTER VOL +/- on the remote.

# Before You Use Your Receiver

## Notes

- The front balance, surround balance, center level, and surround level are shown in the display during adjustment
- Although these adjustments can also be made via the front panel using the LEVEL menu (when the test tone is output, the receiver switches to the LEVEL menu automatically), we recommend you follow the procedure previously described in this section and adjust the speaker levels from your listening position using the remote control

## 💡 When setting the volume levels for each speaker

Let's assume that you have matched the sound levels of all the speakers using the test tone. Although this lays the foundation for high quality surround sound, it may be necessary to make further adjustments while listening to playback of actual software. This is because most software contains center and surround channels recorded at slightly lower levels than the two front channels.

When you actually play back software recorded in multi channel surround, you will notice that increasing the center and surround speaker levels produces a better blend between the front and center speakers and greater cohesion between the front and surround speakers. Increasing the level of the center speaker about 1 dB, and the surround speakers about 1~2 dB is likely to produce better results.

In other words, in order to create a more cohesive soundstage with balanced dialog, we recommend that you make some adjustments while playing your software. Changes of only 1 dB can make a huge difference in the character of the soundstage.

## Checking the connections

After connecting all of your components to the receiver, do the following to verify that the connections were made correctly.

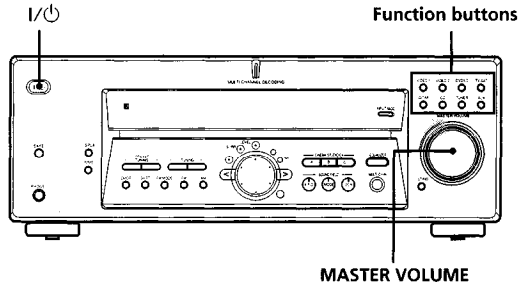

- 1 Press I/Power to turn on the receiver
- 2 Press a function button to select a component (program source) that you connected (e.g., CD player or tape deck)
- 3 Turn on the component and start playing it
- 4 Rotate MASTER VOLUME to turn up the volume

If you do not obtain normal sound output after performing this procedure, look for the reason in the following checklist and take the appropriate measures to correct the problem.

## There is no sound no matter which component is selected

- ➔ Check that both the receiver and all components are turned on
- ➔ Check that the volume level on the display is not set to VOL MIN by turning the MASTER VOLUME
- ➔ Check that the SPEAKERS button is not set to OFF
- ➔ Check that all speaker cords are connected correctly
- ➔ Press MUTING if MUTING appears on the display
- ➔ Check that the headphones are not connected to the PHONES jack. No sound will come from the speakers if the headphones are connected
- ➔ Check that the receiver is not in "Demonstration Mode" (see page 16)

## Before You Use Your Receiver

### There's no sound from a specific component.

- ➔ Check that the component is connected correctly to the audio input jacks for that component
- ➔ Check that the cord(s) used for the connection is (are) fully inserted into the jacks on both the receiver and the component

### No sound is heard from one of the front speakers.

- ➔ Connect a pair of headphones to the PHONES jack to verify that sound is output from the headphones (see "14 SPEAKERS button" and "PHONES jack" on page 25)  
If only one channel is output from the headphones, the component may not be connected to the receiver correctly. Check that all the cords are fully inserted into the jacks on both the receiver and the component.  
If both channels are output from the headphones, the front speaker may not be connected to the receiver correctly. Check the connection of the front speaker which is not outputting any sound.

If you encounter a problem that is not included above, see "Troubleshooting" on page 47

# Location of Parts and Basic Operations

This chapter provides information about the locations and functions of the buttons and controls on the front panel. It also explains basic operations.

www.DataSheet4U.com

## Front Panel Parts Descriptions

### 1 I/⏻ switch

Press to turn the receiver on and off

### 2 DISPLAY button

Press repeatedly to change the information on the display window as follows:

Index name of the component or the preset station\*

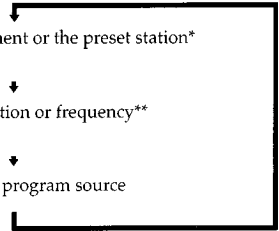

FUNCTION button indication or frequency\*\*

Sound field applied to the program source

\* Index name appears only when you have assigned one to the component or preset station (see page 43) Index name does not appear when only blank spaces have been entered, or it is the same as the function button

\*\* Frequency appears only when the tuner is selected

### 3 DIMMER button

Press repeatedly to adjust the brightness of the display. When you want to turn off the display, set in the "DIM RANGE" parameter in the SET UP menu (page 45)

## Front Panel Parts Description

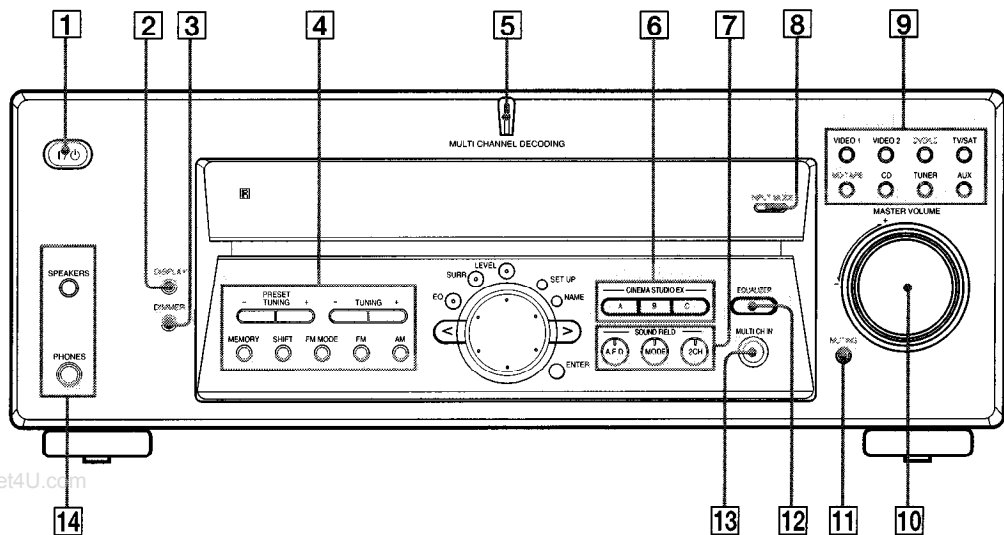

- 4** The following buttons operate the built-in tuner. For details, see "Receiving Broadcasts" starting from page 38

### PRESET TUNING +/- buttons

Scan all preset stations

### TUNING +/- buttons

Scan all the available radio stations

### MEMORY button

Press to memorize a preset station

### SHIFT button

Selects a memory page for preset stations

### FM MODE button

If "STEREO" flashes in the display and the FM stereo reception is poor, press this button. You will not have the stereo effect but the sound is improved.

### FM button

Selects the FM band

### AM button

Selects the AM band

- 5** **MULTI CHANNEL DECODING indicator**

This indicator lights up when the unit is decoding signals recorded in a multi channel format

- 6** Use the CINEMA STUDIO EX buttons to enjoy the CINEMA STUDIO EX sound effects

### A/B/C buttons

Press to activate the CINEMA STUDIO EX A, B or C sound field (page 29)

- 7** Use the SOUND FIELD buttons to enjoy surround sound. For details, see "Enjoying Surround Sound" starting from page 27

### A.F.D. button / indicator

Press to set the receiver to automatically detect the type of audio signal being input and perform proper decoding (if necessary)

### MODE button / indicator

Press to activate the sound field selection mode (page 28)

### 2CH button / indicator

Press to output sound from only the front (left and right) speakers

45



**8 INPUT MODE button**

Press to select the input mode for your digital components (DVD/LD, TV/SAT and MD/TAPE (STR-DE675 only))

Each press switches the input mode of the currently selected component

Select	To
AUTO	Give priority to digital signals when there are both digital and analog connections. If there are no digital signals, analog is selected
DIGITAL (OPTICAL)	Specify the digital audio signals input to the DIGITAL OPTICAL input jacks
DIGITAL (COAXIAL)	Specify the digital audio signals input to the DIGITAL COAXIAL input jacks (DVD/LD only)
ANALOG	Specify the analog audio signals input to the AUDIO IN (L and R) jacks

**Note**

If 96 kHz digital signal is input, the EQ, sound field and surround parameters do not function

**9 Function buttons**

Press one of the buttons to select the component you want to use

To select	Press
VCR	VIDEO 1 or VIDEO 2 (STR-DE675 only) VIDEO (STR-DE575 / K502 only)
DVD or LD player	DVD/LD
TV or satellite tuner	TV/SAT
MD or Tape deck	MD/TAPE
CD player	CD
Built in tuner	TUNER
An audio component	AUX

After selecting the component, turn on the component you selected and play the program source

- After selecting VCR, DVD player, or LD player, turn on the TV and set the TV's video input to match the component you selected

**10 MASTER VOLUME control**

After turning on the component you selected, rotate to adjust the volume

**11 MUTING button**

Press to mute the sound. MUTING appears in the display when the sound is muted

**12 EQUALIZER button**

Press to turn the equalizer on or off. The EQ indicator in the display lights when the equalizer is turned on. When you adjust the equalizer using the EQ parameters (page 36) the settings are stored automatically and can be reproduced wherever you turn on the equalizer

- The equalizer is not compatible with 96 kHz digital audio signals and during MULTI CH IN input

**When you want to listen to an analog source without any digital processing**

Do the following to bypass the sound field and equalizer circuits

- 1 Press 2CH
  - 2 Press EQ to turn off the EQ indicator
- The result will be a sound that is highly faithful to the program source

**13 MULTI CH IN button**

Press to enjoy the audio source connected to the MULTI CH IN jacks with the video from the selected component. Press again to cancel MULTI CH IN

- When the MULTI CH IN is selected, the tone, equalizer, and sound field effects do not function

**14 SPEAKERS button**

Press SPEAKERS button to ON

**PHONES jack**

Connects headphones

- When you connect the headphones, no sound will come from the speakers

## Front Panel Parts Description

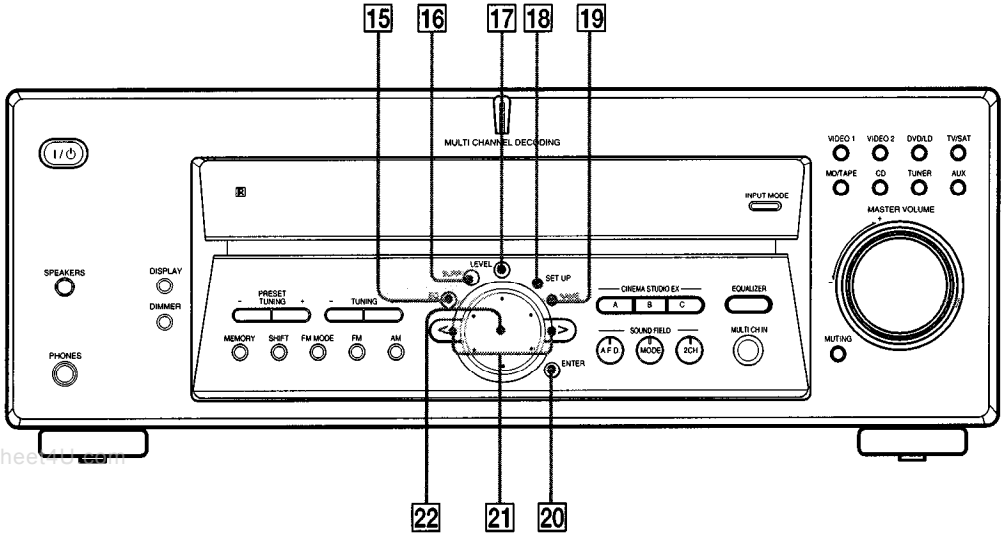

### 15 EQ button

Press to activate the equalizer parameters (page 36)  
The indicator on the button lights up and you can adjust the various equalizer parameters

### 16 SURR button

Press to activate the surround parameters (page 34)  
The indicator on the button lights up and you can adjust the various surround parameters (effect level, wall type, etc )

### 17 LEVEL button

Press to activate the speaker level parameters (page 35)  
The indicator on the button lights up and you can adjust the various speaker level parameters (front balance, surround balance, etc )

### 18 SET UP button

Press to activate the setup mode, then use the cursor buttons (21) to select any of the following indications  
You can then make various settings using the jog dial (22)

When you select	You can
Speaker type	Specify the type of speakers (page 17)
Speaker setup	Specify the front, center, surround speaker sizes, the surround speaker position, and whether or not you are using a sub woofer (page 17)

### When you select

### You can

Speaker Distance	Specify the front, center, and surround speaker distances (page 19)
MULTI CH IN video input	Specify the video input to be used with the audio signals from the MULTI CH IN jacks (page 45)
Dimmer range	Specify the display to turn off when you press the DIMMER button several times (page 45)

### 19 NAME button

Press to activate the name function and enter names for preset stations and program sources (page 43)

### 20 ENTER button

Press to enter individual characters for the preset station and program source names

### 21 Cursor buttons (</>)

Press to select various speaker level, surround, and equalizer parameters (etc )

### 22 Jog dial

Turn to adjust the selected speaker level, surround, and equalizer parameters (etc )

# Enjoying Surround Sound

This chapter describes how to set up the receiver to enjoy surround sound. You can enjoy multi channel surround when playing back software encoded with Dolby Digital or DTS.

You can take advantage of surround sound simply by selecting one of the receiver's pre-programmed sound modes. They bring the exciting and powerful sound of movie theaters and concert halls into your home. You can also customize the sound modes to obtain the sound you desire by changing the various surround parameters. The receiver contains a variety of different sound modes. The cinema sound modes are designed for use when playing back movie software (DVD, LD, etc.) encoded with multi channel surround sound or Dolby Pro Logic. In addition to decoding the surround sound, some of these modes also provide sound effects commonly found in movie theaters.

The virtual sound modes contain compelling applications of the Sony Digital Cinema Sound digital signal processing technology. They shift the sound away from the actual speaker locations to simulate the presence of several "virtual" speakers.

The music (etc.) sound modes are designed for use with standard audio sources and TV broadcasts. They add reverberation to the source signal to make you feel as if you were in a concert hall or stadium (etc.). Use these sound modes with two-channel sources like CD and stereo broadcasts of sports programs or musical concerts. For more information about the sound modes, see pages 29 – 31.

## **A F.D**

The "Auto Format Decoding" sound mode presents the sound exactly as it was encoded, without adding any reverberation (etc.).

To fully enjoy surround sound, you must register the number and location of your speakers. See "Multi-Channel Surround setup" starting on page 17 to set the speaker parameters before enjoying surround sound.

# Selecting a Sound Field

You can enjoy surround sound simply by selecting one of the pre-programmed sound fields according to the program you want to listen to

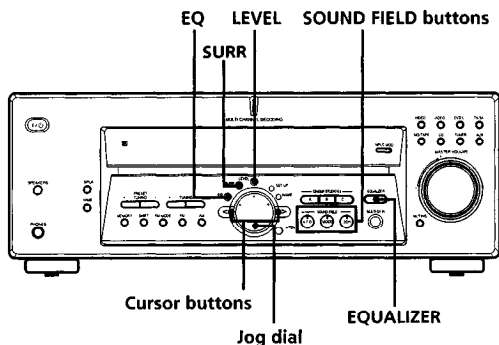

## Brief descriptions of buttons used to enjoy surround sound

**LEVEL button:** Press to customize the level parameters

**SURR button:** Press to customize the surround parameters in the current sound field

**EQ button:** Press to customize the equalizer parameters in the current sound field

**Cursor buttons (</>):** Use to select parameters after pressing the LEVEL, SURR, EQ or SET UP buttons

**Jog dial:** Use to adjust parameters and select sound fields (etc)

### SOUND FIELD buttons:

**A F D button:** Press to set the receiver to automatically detect the type of audio signal being input and perform proper decoding (if necessary)

**MODE button:** Press to activate the sound field selection mode

**2CH button:** Press to output sound from only the front (left and right) speakers

**EQUALIZER button:** Turns the equalizer effect on or off

### 1 Press MODE

The current sound field is indicated in the display

### 2 Turn the jog dial or press the cursor buttons (< or >) to select the sound field you want

See the table starting on page 29 for information on each sound field



### To turn the sound field off

Press A F D or 2CH (page 24)

**💡** The receiver memorizes the last sound field selected for each program source (Sound Field Link)

Whenever you select a program source, the sound field that was last applied is automatically applied again. For example, if you listen to CD with SMALL HALL as the sound field, change to a different program source, then return to CD, SMALL HALL will be applied again. With the tuner, sound fields are memorized separately for AM, FM, and all preset stations

**💡** You can identify Dolby Surround-encoded software by looking at the packaging

Dolby Digital discs are labeled with the  logo, and Dolby Surround encoded programs are labeled with the  logo

## Sound field information

Sound field	Effect	Notes
NORM SURR (NORMAL SURROUND)	Software with multi channel surround audio signals is played according to the way it was recorded Software with two channel audio signals, is decoded with Dolby Pro Logic to create surround effects	
C ST EX A (CINEMA STUDIO EX A) <sup>1)2)</sup> (Press CINEMA STUDIO EX A button)	Reproduces the sound characteristics of Sony Pictures Entertainment's classic editing studio by using the 3D sound imaging of VM DIMENS (page 30) to create 5 sets of virtual speakers surrounding the listener from a single pair of actual surround speakers	This is a standard mode, great for watching most any type of movie
C ST EX B (CINEMA STUDIO EX B) <sup>1)2)</sup> (Press CINEMA STUDIO EX B button)	Reproduces the sound characteristics of Sony Pictures Entertainment's mixing studio which is one of the most up-to-date facilities in Hollywood The 3D sound imaging of VM DIMENS (page 30) is used to create 5 sets of virtual speakers surrounding the listener from a single pair of actual surround speakers	This mode is ideal for watching science-fiction or action movies with lots of sound effects
C ST EX C (CINEMA STUDIO EX C) <sup>1)2)</sup> (Press CINEMA STUDIO EX C button)	Reproduces the sound characteristics of Sony Pictures Entertainment's BGM recording studio by using the 3D sound imaging of VM DIMENS (page 30) to create 5 sets of virtual speakers surrounding the listener from a single pair of actual surround speakers	This mode is ideal for watching musicals or classic films where music is featured in the soundtrack
S C EX A (SEMI CINEMA STUDIO EX A) <sup>1)</sup>	Reproduces the sound characteristics of Sony Pictures Entertainment's classic editing studio using the 3D sound imaging of V SEMI M D (page 30) to create 5 set of virtual speakers surrounding the listener from the sound of the front speakers (without using actual surround speakers)	
S C EX B (SEMI CINEMA STUDIO EX B) <sup>1)</sup>	Reproduces the sound characteristics of Sony Pictures Entertainment's mixing studio which is one of the most up-to-date facilities in Hollywood The 3D sound imaging of V SEMI M D (page 30) is used to create 5 sets of virtual speakers surrounding the listener from the sound of the front speakers (without using actual surround speakers)	
S C EX C (SEMI CINEMA STUDIO EX C) <sup>1)</sup>	Reproduces the sound characteristics of Sony Pictures Entertainment's BGM recording studio using the 3D sound imaging of VSEMI M D (page 30) to create 5 sets of virtual speakers surrounding the listener from the sound of the front speakers (without using actual surround speakers)	

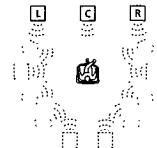

<sup>1)</sup> "VIRTUAL" sound field: Sound field with virtual speakers

<sup>2)</sup> You can select by pressing the buttons on the front panel

# Selecting a Sound Field

## Sound field information

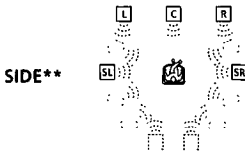
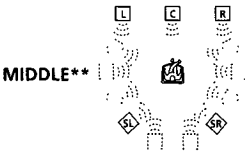
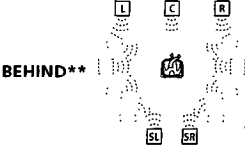
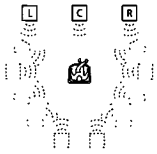
Sound field	Effect	Notes
VM DIMENS <sup>1)</sup> (VIRTUAL MULTI DIMENSION)	Uses 3D sound imaging to create an array of virtual surround speakers positioned higher than the listener from a single pair of actual surround speakers. This mode creates four sets of virtual speakers surrounding the listener at approximately a 30° angle of elevation	 <p>SIDE**</p>
		 <p>MIDDLE**</p>
		 <p>BEHIND**</p>
V SEMI M D <sup>1)</sup> (VIRTUAL SEMI-MULTI DIMENSION)	Uses 3D sound imaging to create virtual surround speakers from the sound of the front speakers without using actual surround speakers. This mode creates five sets of virtual speakers surrounding the listener at a 30° angle of elevation	 <p>V SEMI M D</p>
S HALL (SMALL HALL)	Reproduces the acoustics of a small rectangular concert hall	Ideal for musicals and opera
L HALL (LARGE HALL)	Reproduces the acoustics of a large rectangular concert hall	
JAZZ (JAZZ CLUB)	Reproduces the acoustics of a jazz club	
L HOUSE (LIVE HOUSE)	Reproduces the acoustics of a 300-seat live house	Great for rock or pop music
GAME	Obtains maximum audio impact from video game software	Be sure to set the game machine to stereo mode when using game software with stereo sound capabilities

\*\* See page 18

<sup>1)</sup> "VIRTUAL" sound field: Sound field with virtual speakers

### Notes

- When you select S HALL, L HALL, JAZZ and L HOUSE, no sound is output from the sub woofer
- The effects provided by the virtual speakers may cause increased noise in the play back signal
- When listening to sound fields that employ the virtual speakers, you will not be able to hear any sound coming directly from the surround speakers

Enjoying Surround Sound

www.DataSheet4U.com

**Use the buttons on the front panel to operate the following modes**

<p>A FD          AUTO FORMAT DECODING          (Press the A FD button)</p>	<p>Automatically detects the type of audio signal being input (Dolby Digital, Dolby Pro Logic, or standard two channel stereo) and performs the proper decoding if necessary. This mode presents the sound as it was recorded/encoded, without adding any effects</p>	<p>You can use this mode as a reference. Set the EQUALIZER to OFF while using this mode to hear the source sound exactly as it was recorded</p>
<p>2CH ST          2 CHANNEL          (Press the 2CH button)</p>	<p>Outputs the sound from the front left and right speakers only. Standard two channel (stereo) sources completely bypass the sound field processing. Multi channel surround formats are downmixed to two channels</p>	<p>This allows you to play any source using only the front left and right speakers</p>

**Notes**

- No sound is output from the sub woofer when the 2 CHANNEL mode is selected. To listen to two channel (stereo) sources using the front left and right speakers and a sub woofer, use the AUTO FORMAT DECODING mode
- When you select "Micro Satellite Speaker", internal sound processor will automatically redirect bass sound to subwoofer. If you want to listen to two channel (stereo) sources under this setting, we recommend that you choose AUTO FORMAT DECODING mode so that you can take advantage of your subwoofer to get back correct bass signal

www.DataSheet4U.com

# Understanding the Multi-Channel Surround Displays

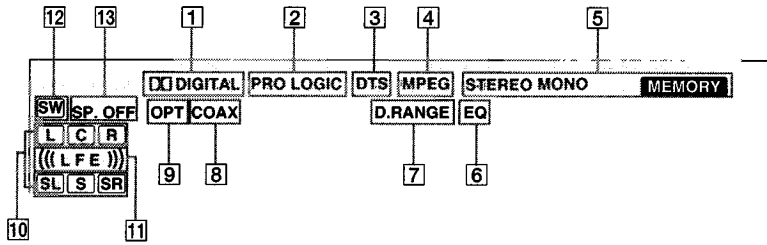

- 1** **DIGITAL**  
This indicator lights up when the receiver is decoding signals recorded in the Dolby Digital (AC-3) format
- 2** **PRO LOGIC**  
Lights up when the receiver applies Pro Logic processing to two channel signals in order to output the center and surround channel signals \*  
*\* However, this indicator does not light if the center and surround speakers are set to "NO", or the SPEAKERS button is set to OFF and the AFD or NORMAL SURROUND sound fields are selected*
- 3** **DTS**  
Lights up when DTS signals are input  
**Note**  
When playing a DTS format disc, be sure that you have made digital connections and that INPUT MODE is NOT set to ANALOG (see [8] on page 25)
- 4** **MPEG**  
Lights up when MPEG signals are input
- 5** **Tuner indicators**  
These indicators light up when using the receiver to tune in radio stations, etc See pages 38 – 41 for tuner operations
- 6** **EQ**  
Lights when the equalizer functions
- 7** **D RANGE**  
Lights up when dynamic range compression is active  
See page 36 to adjust the dynamic range compression
- 8** **COAX**  
Lights up when the source signal is a digital signal being input through the COAX terminal
- 9** **OPT**  
Lights up when the source signal is a digital signal being input through the OPT terminal
- 10** **Play back channel indicators**  
The letters light up to indicate the channels being played back  
L: Front Left                                R: Front Right  
C: Center (monaural)                        SL: Left Surround  
SR: Right Surround  
S: Surround (monaural or the surround components obtained by Pro Logic processing)  
The boxes around the letters light up to indicate the speakers used to playback the channels  
See the next page for details regarding the playback channel indicators
- 11** **((LFE))**  
((LFE)) will light up when the disc being played contains the LFE (Low Frequency Effect) channel and when the sound of the LFE channel signal is actually being reproduced
- 12** **SW**  
Lights up when sub woofer selection is set to "YES" (page 19) and the audio signal is output from the SUB WOOFER jack(s)
- 13** **SP OFF**  
Lights up when headphone is inserted or the SPEAKERS button is set to OFF



**Source sound displays**

The letters (L, C, R, etc.) indicate the source sound. The box around the letters varies to show how the receiver downmixes the source sound (based on the speakers settings). When using music sound modes such as SMALL HALL or JAZZ CLUB, the receiver adds reverberation based on the source sound.

The following table shows how the indicators light up when using AUTO FORMAT DECODING mode.

Although the table below shows almost all of the configurations available from multi channel surround signals, the ones marked "☆" are the most common.

Recording Format (Front/Surround)	Input Channel Display	Source sound and Output Channel Display			
		All speakers present	Surround speakers absent	Center speaker absent	Surround/center speakers absent
1/0	DOLBY DIGITAL [1/0]	DIGITAL [C]	DIGITAL [C]	DIGITAL [C]	DIGITAL [C]
	DTS [1/0]	dtc [C]	dtc [C]	dtc [C]	dtc [C]
2/0*	DOLBY DIGITAL [2/0]	DIGITAL [L R]	DIGITAL [L R]	DIGITAL [L R]	DIGITAL [L R]
	DTS [2/0]	dtc [L R]	dtc [L R]	dtc [L R]	dtc [L R]
3/0	DOLBY DIGITAL [3/0]	DIGITAL [L C R]	DIGITAL [L C R]	DIGITAL [L C R]	DIGITAL [L C R]
	DTS [3/0]	dtc [L C R]	dtc [L C R]	dtc [L C R]	dtc [L C R]
2/1	DOLBY DIGITAL [2/1]	DIGITAL [L R] S	DIGITAL [L R] S	DIGITAL [L R] S	DIGITAL [L R] S
	DTS [2/1]	dtc [L R] S	dtc [L R] S	dtc [L R] S	dtc [L R] S
3/1	DOLBY DIGITAL [3/1]	DIGITAL [L C R] S	DIGITAL [L C R] S	DIGITAL [L C R] S	DIGITAL [L C R] S
	DTS [3/1]	dtc [L C R] S	dtc [L C R] S	dtc [L C R] S	dtc [L C R] S
2/2	DOLBY DIGITAL [2/2]	DIGITAL [L R] SL SR	DIGITAL [L R] SL SR	DIGITAL [L R] SL SR	DIGITAL [L R] SL SR
	DTS [2/2]	dtc [L R] SL SR	dtc [L R] SL SR	dtc [L R] SL SR	dtc [L R] SL SR
3/2	☆ DOLBY DIGITAL [3/2]	DIGITAL [L C R] SL SR	DIGITAL [L C R] SL SR	DIGITAL [L C R] SL SR	DIGITAL [L C R] SL SR
	☆ DTS [3/2]	dtc [L C R] SL SR	dtc [L C R] SL SR	dtc [L C R] SL SR	dtc [L C R] SL SR
2/0**	☆ DOLBY DIGITAL [2/0]	DIGITAL [L C R] PRO LOGIC S	DIGITAL [L C R] PRO LOGIC S	DIGITAL [L C R] PRO LOGIC S	DIGITAL [L R]
	☆ DOLBY PROLOGIC	PRO LOGIC [L C R] S	PRO LOGIC [L C R] S	PRO LOGIC [L C R] S	[L R]
	☆ PCM XX kHz***	[L R]	[L R]	[L R]	[L R]

\* Signals with Dolby Surround encoded flag OFF

\*\* Signals with Dolby Surround encoded flag ON

\*\*\* The sampling rate is displayed

**Notes**

- The receiver performs Pro Logic decoding and the display conforms to 2/0\*\* when using the following movie sound modes with 2/0\* or STEREO PCM format signals (C ST EX A, B, C, S C EX A, B, C, VM DIMENS and V SEMI MD)
- When using music sound modes such as SMALL HALL or JAZZ CLUB with standard audio formats e.g., PCM, the receiver creates surround signals from the front L and R signals. In this case, sound is output from the surround speakers, but output channel indicators for the surround speakers do not light.

# Customizing Sound Fields

www.DataSheet4U.com

By adjusting the surround parameters and the tone characteristics of the front speakers, you can customize the sound fields to suit your particular listening situation

Once you customize a sound field, the changes are stored in memory indefinitely (unless the receiver is unplugged for about one week) You can change a customized sound field any time by making new adjustments to the parameters

See the table on page 37 for the parameters available in each sound field

## To get the most from multi channel surround sound

Position your speakers and do the procedures described in "Multi Channel Surround Setup" starting on page 17 before you customize a sound field

## Adjusting the surround parameters

The SURR menu contains parameters that let you customize various aspects of the current sound field The settings available in this menu are stored individually for each sound field

- 1 Start playing a program source encoded with multi channel surround sound**
- 2 Press SURR**  
The button lights up and the first parameter is displayed
- 3 Press the cursor buttons (< or >) to select the parameter you want to adjust**
- 4 Turn the jog dial to select the setting you want**  
The setting is stored automatically

### Effect level (EFFECT)

Initial setting : (depends on sound mode)

This parameter lets you adjust the "presence" of the current surround effect

### Wall type

Initial setting : WALL MID

When sound is reflected off soft material, such as a curtain, the high frequency elements are reduced A hard wall is highly reflective and does not significantly affect the frequency response of the reflected sound This parameter lets you control the level of the high frequencies to alter the sonic character of your listening environment by simulating a softer (S) or harder (H) wall

- The wall type can be adjusted from WALL S 1 ~ WALL S 8 (soft) to WALL H 1 ~ WALL H 8 (hard) in 17 steps
- The midpoint WALL MID designates a neutral wall (made of wood)

### Reverberation

Initial setting : REVB MID

Before sound reaches our ears, it is reflected (reverberated) many times between the left and right walls, ceiling, and floor In a large room, sound takes more time to bounce from one surface to another than in a smaller room This parameter lets you control the spacing of the early reflections to simulate a sonically larger (L) or smaller (S) room

- The reverberation can be adjusted from REVB S 1 ~ REVB S 8 (short) to REVB L 1 ~ REVB L 8 (long) in 17 steps
- The midpoint REVB MID designates a standard room with no adjustment

### Screen depth

Initial setting : SCR MID

In a movie theater, sound seems to come from inside the image reflected on the movie screen This parameter allows you to create the same sensation in your listening room by shifting the sound of the front speakers "into" the screen

- The screen depth can be set to SCR OFF, SCR MID, or SCR DEEP
- SCR DEEP provides the greatest amount of screen depth

## Adjusting the level parameters

The LEVEL menu contains parameters that let you adjust the balance and speaker volumes of each speaker. The settings available in this menu are applied to all sound fields.

### 1 Start playing a program source encoded with multi channel surround sound

### 2 Press LEVEL

The button lights up and the first parameter is displayed.

### 3 Press the cursor buttons (< or >) to select the parameter you want to adjust

### 4 Turn the jog dial to select the setting you want

The setting is stored automatically.

#### \*Front balance (FRONT)

Initial setting : BALANCE

Lets you adjust the balance between the front left and right speakers

- The balance can be adjusted  $\pm 8$  steps
- These settings can also be adjusted using the supplied remote. See "Adjusting the speaker volume" (page 20)

#### \*Surround balance (SURR)

Initial setting : BALANCE

Lets you adjust the balance between the surround left and right speakers

- The balance can be adjusted  $\pm 8$  steps
- These settings can also be adjusted using the supplied remote. See "Adjusting the speaker volume" (page 20)

#### \*Center level

Initial setting : CTR 0 dB

Lets you adjust the level of the center speaker

- The level can be adjusted in 1 dB steps from -6 dB to +6 dB

#### \*Surround level

Initial setting : SURR 0 dB

Lets you adjust level of the surround (left and right) speakers

- The level can be adjusted in 1 dB steps from -6 dB to +6 dB

#### \*Sub woofer level

Initial setting : S W 0 dB

Lets you adjust the level of the sub woofer

- The level can be adjusted in 1 dB steps from -6 dB to +6 dB

\* The parameters can be adjusted separately for MULTI CH IN

#### Low Frequency Effect

Initial setting : L F E 0 dB

This parameter lets you attenuate the level of the LFE (Low Frequency Effect) channel output from the sub woofer without affecting the level of the bass frequencies sent to the sub woofer from the front, center or surround channels via the bass redirection circuitry

- The level can be adjusted in 1 dB steps from -20 dB to 0 dB (line level). 0 dB outputs the full LFE signal at the mix level determined by the recording engineer
- Selecting OFF mutes the sound of the LFE channel from the sub woofer. However, the low frequency sounds of the front, center, or surround speakers are output from the sub woofer according to the settings made for each speaker in the speaker setup (page 17)

### Dynamic range compressor (D, RANGE)

Initial setting : COMP OFF

Lets you compress the dynamic range of the sound track  
This may be useful when you want to watch movies at low volumes late at night

- COMP OFF reproduces the sound track with no compression
- COMP STD reproduces the sound track with the dynamic range intended by the recording engineer
- COMP 0 1 ~ 0 9 allow you to compress the dynamic range in small steps to achieve the sound you want
- COMP MAX provides a dramatic compression of the dynamic range

#### Note

Dynamic range compression does not work with DTS sources

#### About the Dynamic Range Compressor

This parameter allows you to compress the dynamic range of the soundtrack based on the dynamic range information included in the Dolby Digital signal "COMP. STD" is standard compression, but because many sources have only light compression, you may not notice much difference when using COMP 0 1~0 9

Therefore, we recommend using the "COMP. MAX" setting This greatly compresses the dynamic range and allows you to view movies late at night at low volumes Unlike analog limiters, the levels are predetermined and it provides a very natural compression

### Adjusting the equalizer

The EQ menu lets you adjust the equalization (low and high frequencies) of the front speakers The equalizer settings are stored individually for each sound field

**1 Start playing a program source encoded with multi channel surround sound**

**2 Press EQ**

The button lights up and the first parameter is displayed

**3 Press the cursor buttons (< or >) to select the parameter you want to adjust**

**4 Turn the jog dial to select the setting you want**

The setting is stored automatically

 You can turn off the equalization without erasing it

The equalizer settings are stored separately for each sound field Press the EQUALIZER button to turn the EQ indicator off

#### Front speaker bass adjustment (Level/Frequency)

① Use the cursor buttons (</>) to select the level (dB) or frequency (Hz)

② Use the jog dial to adjust

Repeat until you achieve the sound you desire

- The level can be adjusted  $\pm 6$  dB in 1 dB steps
- The frequency can be adjusted from 99 Hz to 1 0 kHz in 21 steps

#### Front speaker treble adjustment (Level/Frequency)

Adjust as described in "Front speaker bass adjustment"

- The level can be adjusted  $\pm 6$  dB in 1 dB steps
- The frequency can be adjusted from 1 0 kHz to 10 kHz in 23 steps

### Resetting customized sound fields to the factory settings

**1 If the power is on, press I/⏻ to turn off the power.**

**2 Hold down MODE and press I/⏻**

"SF CLR" appears in the display and all sound fields are reset at once

**Adjustable parameters for each sound field**

	EFFECT LEVEL	WALL TYPE	REVERB TIME	SCREEN DEPTH	FRONT BAL	SURR BAL	CENTER LEVEL	SURR LEVEL	SUB WOOFER LEVEL	LFE MIX
2CH					●					●
A FD					●	●	●	●	●	●
NORMAL SURROUND					●	●	●	●	●	●
CINEMA STUDIO EX A	●			●	●	●	●	●	●	●
CINEMA STUDIO EX B	●			●	●	●	●	●	●	●
CINEMA STUDIO EX C	●			●	●	●	●	●	●	●
SEMI CINEMA STUDIO EX A	●			●	●		●		●	●
SEMI CINEMA STUDIO EX B	●			●	●		●		●	●
SEMI CINEMA STUDIO EX C	●			●	●		●		●	●
V MULTI DIMENSION					●	●	●	●	●	●
V SEMI-M DIMENSION					●		●		●	●
SMALL HALL	●	●	●		●	●	●	●	●	●
LARGE HALL	●	●	●		●	●	●	●	●	●
JAZZ CLUB	●	●	●		●	●	●	●	●	●
LIVE HOUSE	●	●	●		●	●	●	●	●	●
GAME	●	●	●		●	●	●	●	●	●
MULTI CH IN					●	●	●	●	●	

	D RANGE COMP.	EQ
2CH	●	●
A FD	●	●
NORMAL SURROUND	●	●
CINEMA STUDIO EX A	●	●
CINEMA STUDIO EX B	●	●
CINEMA STUDIO EX C	●	●
SEMI CINEMA STUDIO EX A	●	●
SEMI CINEMA STUDIO EX B	●	●
SEMI CINEMA STUDIO EX C	●	●
V MULTI DIMENSION	●	●
V SEMI-M DIMENSION	●	●
SMALL HALL	●	●
LARGE HALL	●	●
JAZZ CLUB	●	●
LIVE HOUSE	●	●
GAME	●	●
MULTI CH IN		

# Receiving www.DataSheet4U.com Broadcasts

This chapter describes how to receive FM or AM broadcasts and how to preset selected stations.

You can tune in stations on this receiver in the following ways:

## Direct Tuning

You can enter a frequency of the station you want directly by using the numeric buttons on the remote (see page 40)

## Automatic Tuning

If you don't know the frequency of the station you want, you can let the receiver scan all available stations in your area (see page 40)

## Preset Tuning

After you have tuned in stations using Direct Tuning or Automatic Tuning, you can preset them to the receiver (see page 41) Then you can tune in any of the stations directly by entering its 2-character code (see page 41) Up to 30 FM or AM stations can be preset The receiver will also scan all the stations that you have preset (see page 41)

Before you begin, make sure you have:

- Connected an FM and AM antenna to the receiver (see page 5)

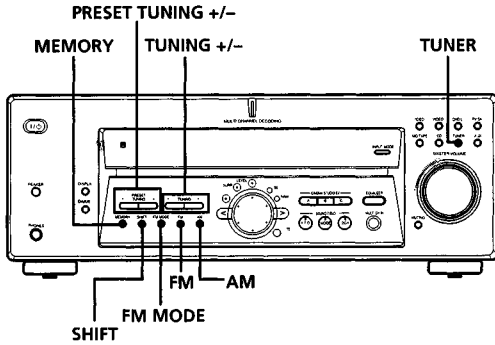

Models of area code U (STR-DE575 only)

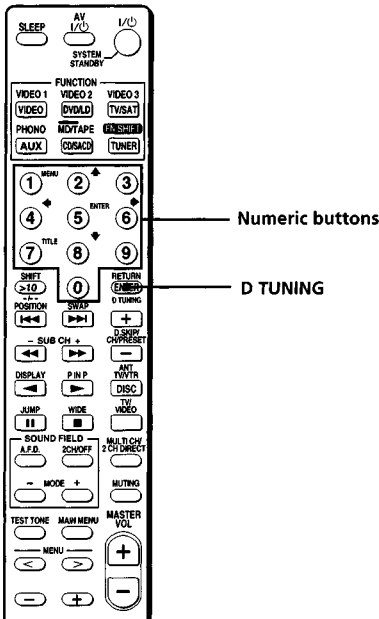

**Brief descriptions of buttons used to receive broadcasts**

**PRESET TUNING +/-:** Press to scan all preset radio stations

**TUNING +/-:** Press to scan all available radio stations

**FM MODE:** If "STEREO" flashes in the display and the FM stereo reception is poor, press this button to improve the sound. You will not be able to enjoy stereo effect but the sound will be less distorted

**Note**

If "STEREO" does not appear at all even when the FM broadcast is received normally, press this button to turn on the "STEREO" indication

**FM:** Press to select the FM band

**AM:** Press to select the AM band

**MEMORY:** Uses for memorizing preset stations

**SHIFT:** Press to select a memory page (A, B, or C) for presetting radio stations or tuning to preset stations

**TUNER:** Press to select the tuner

**On the remote:**

**D TUNING:** Press this button to enter a frequency directly using the numeric buttons

**Numeric buttons:** Press to enter a numeric value when inputting the frequency directly, presetting radio stations, or tuning to preset stations

# Direct Tuning

www.DataSheet4U.com

For details on the buttons used in this section, see "Brief descriptions of buttons used to receive broadcasts" on page 39

- 1 Press TUNER**  
The last received station is tuned in
- 2 Press FM or AM to select the FM or AM band**
- 3 Press D TUNING on the remote**
- 4 Press the numeric buttons on the remote to enter the frequency.**

Example 1: FM 102.50 MHz

① → ② → ⑤ → ① → ②

Example 2: AM 1350 kHz

(You don't have to enter the last "0" when the tuning interval is set to 10 kHz)

① → ③ → ⑤ → ①

## If you cannot tune in a station and the entered numbers flash

Make sure you've entered the right frequency. If not, repeat Steps 3 and 4.

If the entered numbers still flash, the frequency is not used in your area.

- 5 If you've tuned in an AM station, adjust the direction of the AM loop antenna for optimum reception**
- 6 Repeat Steps 2 to 5 to receive other stations**

 **If you try to enter a frequency not covered by the tuning interval**

The entered value is automatically rounded up or down.

Tuning intervals for direct tuning are:

**FM:** 50 kHz

**AM:** 10 kHz (to change to 9 kHz, see page 50)

# Automatic Tuning

For details on the buttons used in this section, see "Brief descriptions of buttons used to receive broadcasts" on page 39

- 1 Press TUNER**  
The last received station is tuned in
- 2 Press FM or AM to select the FM or AM band**
- 3 Press TUNING + or TUNING -**  
Press the + button to scan from low to high; press the - button to scan from high to low

## When the receiver reaches either end of the band

Scanning is repeated in the same direction

The receiver stops scanning whenever a station is received

- 4 To continue scanning, press TUNING + or TUNING - again**

www.DataSheet4U.com



# Preset Tuning

www.DataSheet4U.com

For details on the buttons used in this section, see "Brief descriptions of buttons used to receive broadcasts" on page 39

Before tuning to preset stations, be sure to preset them by performing steps on "Presetting radio stations" below

## Presetting radio stations

- 1 Press TUNER**  
The last received station is tuned in
- 2 Tune in the station that you want to preset using Direct Tuning or Automatic Tuning (page 40)**
- 3 Press MEMORY**  
"MEMORY" appears in the display for a few seconds  
Do Steps 4 to 6 before "MEMORY" goes out
- 4 Press SHIFT to select a memory page (A, B or C)**  
Each time you press SHIFT, the letter "A", "B" or "C" appears in the display
- 5 Select a preset number by pressing PRESET TUNING + or PRESET TUNING -**  
If "MEMORY" goes out before you press the preset number, start again from Step 3
- 6 Press MEMORY again to store the station**  
If "MEMORY" goes out before you can store the station, start again from Step 3
- 7 Repeat Steps 2 to 6 to preset another station**

### To change a preset number to another station

Do Steps 1 to 6 to preset the new station to the number

#### Note

If the AC power cord is disconnected for about one week, all the preset stations will be cleared from the receiver's memory, and you will have to preset the stations again

## Tuning to preset stations

You can tune the preset stations either of the following two ways

### Scanning the preset stations

#### 1 Press TUNER

The last received stations is tuned in

#### 2 Press PRESET TUNING + or PRESET TUNING - repeatedly to select the preset station you want

Each time you press the button, the receiver tunes in one preset station at a time, in the corresponding order and direction as follows:

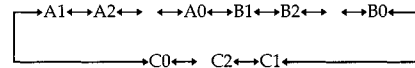

### Using the preset codes

#### 1 Press TUNER

The last received stations is turned in

#### 2 Press SHIFT to select a memory page (A, B or C), then press the preset number of the station you want using the numeric buttons on the supplied remote

www.DataSheet4U.com

# Other www.DataSheet4U.com Operations

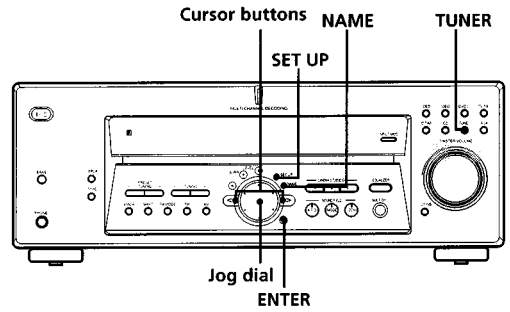

## Brief descriptions of buttons that appear in this chapter

**NAME button:** Press to name preset stations or program sources

**Jog dial:** Use to select characters when naming preset stations or program sources

**Cursor buttons (< / >):** Use to move the cursor when naming preset stations or program sources

**TUNER button:** Press to select the tuner

**SET UP button:** Press to enter the set up mode

**ENTER button:** Press to enter the completed name of the preset station or program source

# Naming Preset Stations and Program Sources

You can enter a name (index name) of up to 8 characters for preset stations and program sources. These names (for example, "VHS") appear in the receiver's display when a station or program source is selected.

Note that no more than one name can be entered for each preset station or program source.

This function is useful for distinguishing components of the same kind. For example, two VCRs can be specified as "VHS" and "8MM", respectively. It is also handy for identifying components connected to jacks meant for another type of component, for example, a second CD player connected to the MD/TAPE jacks.

## 1 To name a preset station

### Press TUNER

The last station you received is tuned in.

### To name a program source

Select the program source (component) to be named, then go to Step 3.

## 2 Tune in the preset station you want to create an index name for.

If you are not familiar with how to tune in preset stations, see "Tuning to preset stations" on page 41.

## 3 Press NAME

## 4 Create an index name by using the jog dial and cursor buttons:

Turn the jog dial to select a character, then press > to move the cursor to the next position.

### To insert a space

Turn the jog dial until a blank space appears in the display (you can find the space character between "J" and "A").

### If you've made a mistake

Press < or > repeatedly until the character to be changed flashes, then turn the jog dial to select the right character.

## 5 Press ENTER

### To assign index names to other stations

Repeat Steps 2 to 5.

# Recording

Your receiver makes it easy to record to and from the components connected to it. You don't have to connect the playback and recording components directly to each other: once you select a program source on the receiver, you can record and edit as you normally would using the controls on each component.

Before you begin, make sure you've connected all components properly.

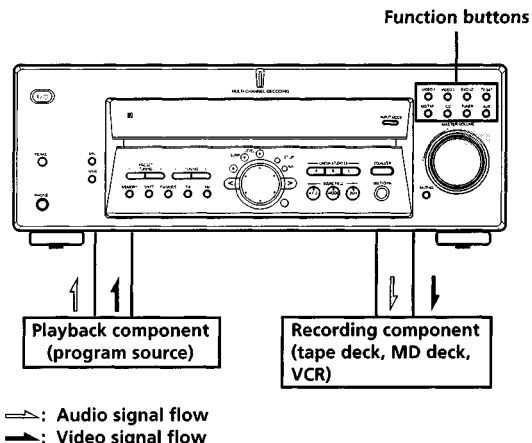

## Recording on an audio tape or MiniDisc

You can record on a cassette tape or MiniDisc using the receiver. Refer to the instruction manual of your cassette deck or MD deck if you need help.

## 1 Select the component to be recorded

**2 Prepare the component for playing**  
For example, insert a CD into the CD player.

**3 Insert a blank tape or MD into the recording deck and adjust the recording level, if necessary.**

**4 Start recording on the recording deck, then start playback on the playback component.**

## Recording

www.DataSheet4U.com

### Recording on a video tape

You can record from a TV, or an LD player using the receiver. You can also add audio from a variety of audio sources when editing a video tape. See your LD player's instruction manual if you need help.

#### 1 Select the program source to be recorded

#### 2 Prepare the component for playing

For example, insert the laser disc you want to record into the LD player.

#### 3 Insert a blank video tape into the VCR for recording

#### 4 Start recording on the recording VCR, then start playing the laser disc you want to record

#### 💡 You can record the sound from any audio source onto a video tape while recording from a laser disc

Locate the point where you want to start recording from another audio source, select the program source, then start playback. The audio from that source will be recorded onto the audio track of the video tape instead of the audio from the original medium.

To resume audio recording from the original medium, select the video source again.

#### Notes

- You cannot record a digital audio signal using a component connected to the analog MD/TAPE OUT or VIDEO OUT jacks.
- Sound adjustments do not affect the signal output from the MD/TAPE OUT or VIDEO OUT jacks.
- When MULTI CH IN is selected, audio signals are not output from MD/TAPE OUT or VIDEO OUT jacks.

## Using the Sleep Timer

You can set the receiver to turn off automatically at a specified time.

#### Press SLEEP on the remote while the power is on

Each time you press SLEEP, the time changes as shown below.

→ 2-00-00 → 1-30-00 → 1-00-00 → 0-30-00 → OFF

The display dims after you have specified the time.

#### 💡 You can freely specify the time

First, press SLEEP on the remote, then specify the time you want using the jog dial on the receiver. The sleep time changes in 1 minute intervals. You can specify up to 5 hours.

#### 💡 You can check the time remaining before the receiver turns off

Press SLEEP on the remote. The remaining time appears in the display.

# Adjustment Using the SET UP Button

The SET UP button allows you to make the following adjustments

## Selecting the MULTI CH IN video input

This parameter lets you specify the video input to be used with the audio signals from the MULTI CH IN jack. The MULTI CH IN video input is set to DVD/LD by default.

- 1 Press SET UP.
- 2 Press the cursor buttons (< or >) to select "MULTI CH IN: VISUAL"
- 3 Turn the jog dial to select the video input you want

## Set the display to turn off

This parameter lets you specify whether or not the display turns off when you press the DIMMER button several times. When "WIDE" is selected, you can set the display to turn off, but when "NARROW" is selected, you cannot set the display to turn off. The default setting is set to "NARROW"

- 1 Press SET UP.
- 2 Press the cursor buttons (< or >) to select "DIM RANGE"
- 3 Turn the jog dial to select "NARROW" or "WIDE"

# CONTROL A1II Control System (STR-DE675 only)

## Getting Started

This section explains the basic functions of the CONTROL A1II Control System. Certain components have special functions, like "CD Synchro Dubbing" on cassette decks, that require CONTROL A1II connections. For detailed information regarding specific operations, be sure to also refer to the Operating Instructions supplied with your component(s).

The CONTROL A1II Control System was designed to simplify the operation of audio systems composed of separate Sony components. CONTROL A1II connections provide a path for the transmission of control signals which enable automatic operation and control features usually associated with integrated systems. Currently, CONTROL A1II connections between a Sony CD player, amplifier (receiver), MD deck and cassette deck provide automatic function selection and synchronized recording. In the future the CONTROL A1II connection will work as a multifunction bus allowing you to control various functions for each component.

## Notes

- The CONTROL A1II Control System is designed to maintain upward compatibility as the Control System is upgraded to handle new functions. In this case, however, older components will not be compatible with the new functions.
- Do not operate a 2 way remote control unit when the CONTROL A1II jacks are connected via a PC interface kit to a personal computer running "MD Editor" or similar application. Also, do not operate the connected component in a manner contrary to the functions of the application, as this may cause the application to operate incorrectly.

## CONTROL A1II and CONTROL A1 compatibility

The CONTROL A1 control system has been updated to the CONTROL A1II which is the standard system in the SONY 300 disc CD changer and other recent Sony components. Components with CONTROL A1 jacks are compatible with components with CONTROL A1II, and can be connected to each other. Basically, the majority of the functions available with the CONTROL A1 control system will be available with the CONTROL A1II control system.

However, when making connections between components with CONTROL A1 jacks and components with CONTROL A1II jacks, the number of functions that can be controlled may be limited depending on the component. For detailed information, refer to the Operating Instructions supplied with the component(s).

**Connections**

Connect monaural (2P) mini-plug cords in series to the CONTROL A1II jacks on the back of each component. You can connect up to ten CONTROL A1II compatible components in any order. However, you can connect only one of each type of component (i.e., 1 CD player, 1 MD deck, 1 tape deck and 1 receiver).

(You may be able to connect more than one CD player or MD deck, depending on the model. Refer to the operating instructions supplied with the respective component for details.)

**Example**

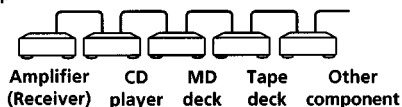

In the CONTROL A1II control system, the control signals flow both ways, so there is no distinction of IN and OUT jacks. If a component has more than one CONTROL A1II jack, you can use either one, or connect different components to each jack.

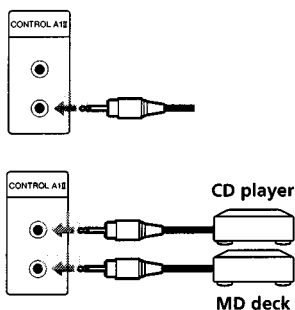

**On CONTROL A1 jacks and connections**

It is possible to make connections between CONTROL A1 and CONTROL A1II jacks. For details regarding particular connections or setup options, refer to the Operating Instructions supplied with the component(s).

**About the connecting cord**

Some CONTROL A1 compatible components are supplied with a connecting cord as an accessory. In this case, use the connecting cord for your connection.

When using a commercially available cord, use a monaural (2P) mini-plug cord less than 2 meters long, with no resistance (like the Sony RK-G69HG).

**Basic Functions**

The CONTROL A1II functions will operate as long as the component you want to operate is turned on, even if all of the other connected components are not turned on.

**Automatic function selection**

When you connect a CONTROL A1II compatible Sony amplifier (or receiver) to other Sony components using monaural mini-plug cords, the function selector on the amplifier (or receiver) automatically switches to the correct input when you press the play button on one of the connected components.

**Notes**

- You must connect a CONTROL A1 compatible amplifier (receiver) using a monaural mini-plug cord in order to take advantage of the automatic function selection feature.
- This function only works when the components are connected to the amplifier (or receiver) inputs according to the names on the function buttons. Certain receivers allow you to switch the names of the function buttons. In this case, refer to the Operating Instructions supplied with the receiver.
- When recording, do not play any components other than the recording source. It will cause the automatic function selection to operate.

**Synchronized recording**

This function lets you conduct synchronized recording between the selected source and recorder components.

- 1 Set the function selector on the amplifier (or receiver) to the source component**
- 2 Set the source component to pause mode (make sure both the ► and II indicators light together)**
- 3 Set the recorder component to the REC-PAUSE mode**
- 4 Press PAUSE on the recorder component**  
The source component is released from the pause mode, and recording begins shortly thereafter. When playback ends from the source component, recording stops.

**Notes**

- Do not set more than one component to the pause mode.
- Certain recorder components may be equipped with a special synchronized recording function that uses the CONTROL A1II Control System, like "CD Synchro Dubbing". In this case, refer to the Operating Instructions supplied with the recorder component.

## Troubleshooting

If you experience any of the following difficulties while using the receiver, use this troubleshooting guide to help you remedy the problem. Also, see “Checking the connections” on page 21 to verify that the connections are correct. Should any problem persist, consult your nearest Sony dealer.

### **There’s no sound or only a very low-level sound is heard**

- ➔ Check that the speakers and components are connected securely.
- ➔ Make sure that you’ve selected the correct component on the receiver.
- ➔ Check that the SPEAKERS button is not set to OFF.
- ➔ Press MUTING if MUTING appears on the display.
- ➔ The protective device on the receiver has been activated because of a short circuit. Turn off the receiver, eliminate the short-circuit problem and turn on the power again.

### **The left and right sounds are unbalanced or reversed**

- ➔ Check that the speakers and components are connected correctly and securely.
- ➔ Adjust front balance parameter in the LEVEL menu.

### **Severe hum or noise is heard**

- ➔ Check that the speakers and components are connected securely.
- ➔ Check that the connecting cords are away from a transformer or motor, and at least 10 feet (3 meters) away from a TV set or fluorescent light.
- ➔ Move your TV away from the audio components.
- ➔ The plugs and jacks are dirty. Wipe them with a cloth slightly moistened with alcohol.

### **No sound is heard from the center speaker**

- ➔ Make sure the sound field function is on (press SOUND FIELD MODE).
- ➔ Select the appropriate center mode (see pages 28 – 31).
- ➔ Adjust the speaker volume (see page 20).
- ➔ Make sure the center speaker size parameter is set to either SMALL or LARGE (see page 18).

### No sound or only a very low-level sound is heard from the surround speakers

- ➔ Make sure the sound field function is on (press SOUND FIELD MODE)
- ➔ Select the appropriate center mode (see pages 28 – 31)
- ➔ Adjust the speaker volume (see page 20)
- ➔ Make sure the surround speaker size parameter is set to either SMALL or LARGE (see page 18)

### No sound is heard from the sub woofer.

- ➔ Make sure the sub woofer is set to YES (see page 19)
- ➔ Check that 2CH mode has not been selected (see page 31)

### Recording cannot be done

- ➔ Check that the components are connected correctly
- ➔ Select the source component with a FUNCTION button
- ➔ When recording from a digital component, make sure the input mode is set to ANALOG (see page 25) before recording with a component connected to the analog MD/TAPE terminals

### Radio stations cannot be tuned in

- ➔ Check that the antennas are connected securely  
Adjust the antennas and connect an external antenna if necessary
- ➔ The signal strength of the stations is too weak (when tuning in with automatic tuning) Use direct tuning
- ➔ Make sure you set the tuning interval correctly (when tuning in AM stations with direct tuning) (see pages 40 and 50)
- ➔ No stations have been preset or the preset stations have been cleared (when tuning by scanning preset stations) Preset the stations (see page 41)
- ➔ Press DISPLAY so that the frequency appears in the display

### The surround effect cannot be obtained

- ➔ Make sure the sound field function is on (press SOUND FIELD MODE)

### “PCM-kHz” appears on the display

- ➔ The sampling frequency is more than 48 kHz  
Change the input player setting to 48 kHz

### Nothing appears on the display.

- ➔ When the display turns off immediately after the receiver is turned on, press DIMMER to change the display mode

### No picture or an unclear picture appears on the TV screen or monitor.

- ➔ Select the appropriate function on the receiver
- ➔ Set your TV to the appropriate input mode
- ➔ Move your TV away from the audio components

### The remote does not function

- ➔ Point the remote at the remote sensor  on the receiver
- ➔ Remove any obstacles in the path between the remote and the receiver
- ➔ Replace both batteries in the remote with new ones, if they are weak
- ➔ Make sure you select the correct function on the remote
- ➔ If the remote is set to operate the TV only, use the remote to select a source or component other than TV before operating the receiver or other component

### Reference sections for clearing the receiver's memory

To clear	See
All memorized settings	page 16
Customized sound fields	page 36



# Specifications

www.DataSheet4U.com

## AUDIO POWER SPECIFICATIONS

### POWER OUTPUT AND TOTAL HARMONIC DISTORTION:

With 8 ohm loads, both channels driven, from 20 - 20,000 Hz; rated 100 watts per channel minimum RMS power, with no more than 0.09% total harmonic distortion from 250 milliwatts to rated output (USA model only).

## Amplifier section

### Rated Power Output at Stereo mode

(8 ohms 20 Hz - 20 kHz,  
THD 0.09%)  
100 W + 100 W

### Reference Power Output

(8 ohms at 1 kHz, THD  
0.7%)  
Front<sup>1)</sup>: 100 W / ch  
Center<sup>1)</sup>: 100 W  
Surround<sup>1)</sup>: 100 W / ch

<sup>1)</sup> Depending on the sound field settings and sources, there may be no sound output

### Frequency response

MULTI CH IN, CD,  
MD / TAPE, DVD /  
LD, TV / SAT,  
VIDEO\*, VIDEO 1\*\*,  
VIDEO 2\*\*, AUX:  
10 Hz - 50 kHz +0.5/  
-2 dB (with sound  
field and equalizer  
bypassed)

### Inputs (Analog)

MULTI CH IN, CD,  
DVD / LD, MD /  
TAPE, TV / SAT,  
VIDEO\*, VIDEO 1\*\*,  
VIDEO 2\*\*, AUX:  
Sensitivity: 250 mV  
Impedance: 50  
kilohms  
S/N<sup>a)</sup>: 96 dB (A, 250  
mV<sup>b)</sup>)

*a) Input short*

*b) Weighted network, input level*

### Inputs (Digital)

DVD / LD (coaxial):  
Sensitivity: -  
Impedance: 75 ohms  
S/N: 100 dB (A, 20  
kHz LPF)  
DVD / LD, TV / SAT,  
MD / TAPE\*\*  
(Optical):  
Sensitivity: -  
Impedance: -  
S/N: 100 dB (A, 20  
kHz LPF)

### Outputs

MD / TAPE, (OUT);  
VIDEO\*, VIDEO 1\*\*,  
VIDEO 2\*\* (AUDIO  
OUT):  
Voltage: 250 mV,  
Impedance: 10  
kilohms  
SUB WOOFER:  
Voltage: 2 V  
Impedance: 1  
kilohms  
PHONES:  
Accepts low- and  
high-impedance  
headphones

### EQ

±6 dB

### Sampling Frequency

48 kHz (TV / SAT, MD /  
TAPE OPTICAL IN)  
96 kHz (DVD / LD  
OPTICAL IN,  
COAXIAL IN)

\* STR-DE575/K502 only

\*\* STR-DE675 only

www.DataSheet4U.com

## Specifications

www.DataSheet4U.com

### FM tuner section

**Tuning range** 87.5 - 108.0 MHz

**Antenna terminals**  
75 ohms, unbalanced

**Intermediate frequency**  
10.7 MHz

**Sensitivity** Mono: 18.3 dBf,  
2.2  $\mu$ V/75 ohms  
Stereo: 38.3 dBf  
22.5  $\mu$ V/75 ohms

**Usable sensitivity**  
11.2 dBf, 1  $\mu$ V/75 ohms

**S/N** Mono: 76 dB  
Stereo: 70 dB

**Harmonic distortion at 1 kHz**  
Mono: 0.3%  
Stereo: 0.5%

**Separation** 45 dB at 1 kHz

**Frequency response**  
30 Hz - 15 kHz +0.5/-2 dB

**Selectivity** 60 dB at 400 kHz

### AM tuner section

**Tuning range** With 10-kHz tuning scale:  
530 - 1710 kHz<sup>c)</sup>  
With 9-kHz tuning scale:  
531 - 1710 kHz<sup>c)</sup>

**Antenna** Loop antenna

**Intermediate frequency**  
450 kHz

**Usable sensitivity**  
50 dB/m (at 1,000 kHz  
or 999 kHz)

**S/N** 54 dB (at 50 mV/m)

**Harmonic distortion**  
0.5% (50 mV/m, 400 kHz)

**Selectivity** At 9 kHz: 35 dB  
At 10 kHz: 40 dB

*c) You can change the AM tuning interval to 9 kHz. After tuning in any AM station, turn off the receiver. Hold down the TUNING + button and press the V/C button. All preset stations will be erased when you change the tuning interval. To reset the scale to 10 kHz, repeat the procedure.*

### Video section

**Inputs** Video: 1 Vp-p 75 ohms  
S-video\*\*\*:  
Y: 1 Vp-p 75 ohms  
C: 0.286 Vp-p 75 ohms

**Outputs** Video: 1 Vp-p 75 ohms  
S-video\*\*\*:  
Y: 1 Vp-p 75 ohms  
C: 0.286 Vp-p 75 ohms

\*\*\* STR-DE675/DE575 only

### General

**System** Tuner section:  
PLL quartz-locked digital synthesizer system  
Preamplifier section:  
Low-noise NF type equalizer  
Power amplifier section:  
Pure-complementary SEPP

**Power requirements**  
120 V AC, 60 Hz

### Power consumption

Models of area code U:  
STR-DE675/DE575/  
K502: 220W  
In standby condition:  
1 W  
Models of area code CA:  
STR-DE675/DE575:  
315 VA  
In standby condition:  
1 W

### AC outlets (STR-DE675 only)

1 switched, total  
120 W/1A Max

**Dimensions** STR-DE675:  
430 × 308.5 × 157.5 mm  
(14.5 × 10.4 × 5.3 in.)  
STR-DE575/K502:  
430 × 296 × 157.5 mm  
(14.5 × 10 × 5.3 in.)  
including projecting parts and controls

### Mass (Approx.)

STR-DE675: 7.5 kg  
(16 lbs 9 oz.)  
STR-DE575/K502:  
7.4 kg  
(16 lbs 6 oz.)

### Supplied accessories

See page 4

For details on the area code of the component you are using, see page 3

Design and specifications are subject to change without notice

## Surround sound

Sound that consists of three elements: direct sound, early reflected sound (early reflections) and reverberative sound (reverberation). The acoustics of the surrounding space affect the way these three sound elements are heard. Surround sound combines these sound elements in such a way that you actually can sense the size of the venue, as well as its type.

### • Types of sound

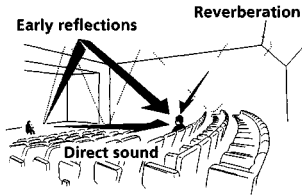

### • Transition of sound from surround speakers

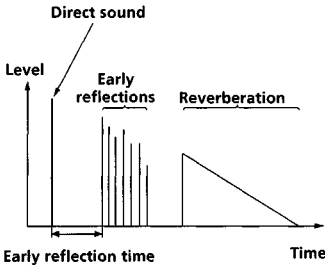

## Dolby Pro Logic Surround

As one method of decoding Dolby Surround, Dolby Pro Logic Surround produces four channels from two-channel sound. Compared with the former Dolby Surround system, Dolby Pro Logic Surround reproduces left-to-right panning more naturally and localizes sounds more precisely. To take full advantage of Dolby Pro Logic Surround, you should have one pair of surround speakers and a center speaker. The surround speakers output monaural sound.

## Dolby Digital (AC-3)

This sound format for movie theaters is more advanced than Dolby Pro Logic Surround. In this format, the surround speakers output stereo sound with an expanded frequency range and a sub woofer channel for deep bass is independently provided. This format is also called "5.1" because the sub woofer channel is counted as 0.1 channel (since it functions only when a deep bass effect is needed). All six channels in this format are recorded separately to realize superior channel separation. Furthermore, since all the signals are processed digitally, less signal degradation occurs. The name "AC-3" comes from the fact that it is the third audio coding method to be developed by the Dolby Laboratories Licensing Corporation.

## Digital Cinema Sound

This is the generic name of the surround sound produced by digital signal processing technology developed by Sony. Unlike previous surround sound fields mainly directed at the reproduction of music, Digital Cinema Sound is designed specifically for the enjoyment of movies.

# Settings Using SURR, LEVEL, EQ, and SET UP buttons

www.DataSheet4U.com

You can make various settings using the LEVEL, SURR, EQ, SET UP buttons, cursor buttons and jog dial. The table below shows each of the settings that these buttons can make.

Press and light	Press < or > to select	Turn jog dial to select	See page
SURR button	EFFECT LEVEL	depends on sound mode (in 16 steps)	34
	WALL TYPE	between -8 to +8 (in 1 increment steps)	
	REVERBERATION TIME	-8 to +8 (in 1 increment steps)	
	SCREEN DEPTH	SCR OFF, SCR MID or SCR DEEP	
LEVEL button	FRONT BALANCE	between -8 to +8 (in 1 increment steps)	35
	SURR BALANCE	between -8 to +8 (in 1 increment steps)	
	CENTER LEVEL	between -6 dB to +6 dB (in 1 dB steps)	
	SURR LEVEL	between -6 dB to +6 dB (in 1 dB steps)	
	SUB WOOFER LEVEL	between -6 dB to +6 dB (in 1 dB steps)	
	LFE MIX LEVEL	OFF, or -20 dB to 0 dB (in 1 dB steps)	
	DYNAMIC RANGE COMP	OFF, 0.1 to 0.9 (in 0.1 dB steps), STD, or MAX	
EQ button	FRONT BASS GAIN	between -6 dB to +6 dB (in 1 dB steps)	36
	FRONT BASS FREQUENCY	between 99 Hz and 10 kHz (in 21 steps)	
	FRONT TREBLE GAIN	between -6 dB to +6 dB (in 1 dB steps)	
	FRONT TREBLE FREQUENCY	between 10 kHz and 10 kHz (in 23 steps)	
*SET UP	[L] [R] (FRONT)	LARGE or SMALL	17
	[C] (CENTER)	LARGE, SMALL, or NO	
	[S] [SR] (SURR)	LARGE, SMALL, or NO	
	S W (SUB WOOFER)	S W YES or S W NO	
	[L] [R] (FRONT) XX X ft	between 3 feet (1.0 meters) and 40 feet (12.0 meters) (in 1 foot (0.1 meter) steps)	
	[C] (CENTER) XX X ft	between FRONT and 5 feet (1.5 meters) (in 1 foot (0.1 meter) steps)	
	[S] [SR] (SURR) XX X ft	between FRONT and 15 feet (4.5 meters) (in 1 foot (0.1 meter) steps)	
	[S] [SR] (SURR) PL XX X	PL SIDE, PL MID or PL BEHD	
	[S] [SR] (SURR) HGT XX X	HGT LOW or HGT HIGH	
	[MULTI CH IN] VISUAL XX X	V-VIDEO, V-DVD/LD, V-TV/SAT (STR-DE575/K502 only)	
	V-VIDEO 1, V-VIDEO 2, V-DVD/LD, V-TV/SAT (STR-DE675 only)		
	DIM RANGE	NARROW or WIDE	

\* When you press the SET UP button, you can select NORM SP (for normal speakers) or MICRO SP (for Micro Satellite speakers) (page 17)

# Remote Button Description

www.DataSheet4U.com

## Models of Area Code U (STR-DE575/K502 only)

You can use the remote RM-U305 to operate the components in your system. The tables below show the settings of each button.

Remote Button	Operations	Function
SLEEP	* Receiver	Activates the sleep function and the duration which the receiver turns off automatically
AV I/⏻	TV/VCR/ CD player/ DVD player/ MD deck/ VCD player/ LD player/ DAT deck	Turns the audio and video components on or off
I/⏻	Receiver	Turns the receiver on or off
VIDEO/ VIDEO 1	Receiver	To watch VCR (VTR mode 3)
VIDEO 2	Receiver	To watch VCR (VTR mode 1)
VIDEO 3	Receiver	To watch VCR (VTR mode 2)
DVD/LD	Receiver	To watch DVD or laser disc
TV/SAT	Receiver	To watch TV programs or satellite receiver
MD/TAPE	Receiver	To listen to Minidisc or audio tape
CD/SACD	Receiver	To listen to compact disc
TUNER	Receiver	To listen to radio programs
PHONO	Receiver	To listen to turn table
AUX	Receiver	To listen to an audio equipment
FN SHIFT*	Remote	Use simultaneously to select other function
0-9	Receiver	Use with "SHIFT" button to select tuner preset station numeric input during DIRECT TUNING or MEMORY mode
	CD player/ MD deck/ VCD player/ LD player/ DAT deck	Selects track numbers 0 selects track 10
	TV/VCR/SAT	Selects channel numbers
>10	CD player/ MD deck/ Tape deck/ LD player/ VCD player	Selects tracks numbers over 10

Remote Button	Operations	Function
ENTER	TV/VCR/SAT/ Tape deck/ LD player/ VCD player/ MD deck/ DAT deck	After selecting a channel, disc or track using the numeric buttons, press to enter the value
SHIFT	Receiver	Press repeatedly to select a memory page for presetting radio stations or tuning to preset stations
-/--	TV	Selects the channel entry mode, either one or two digit
D TUNING	Receiver	Tuner station direct key-in mode
◀▶	CD player/ MD deck/ DVD player/ LD player/ VCD player/ Tape deck/VCR/ DAT deck	Skips tracks
◀▶	CD player/ DVD player/ VCD player	Searches tracks (forward or backward)
	MD deck/ Tape deck/ VCR/ LD player/ DAT deck	Fastforwards or rewinds
◀	Tape deck	Starts play on the reverse side
▶	CD player/ MD deck/Tape deck/VCR/ DVD player/ VCD player/ LD player/ DAT deck	Starts play.

\* VIDEO 1, VIDEO 2, VIDEO 3, PHONO and MD/TAPE function is a 2-key operation. To select the above function, press FN SHIFT (function shift) and the function key you want simultaneously. For example, press FN SHIFT and CD/SACD to select MD/TAPE function.

### Note

When you press the function buttons (VIDEO, DVD/LD, TV/SAT), the input mode of the TV might not switch to the corresponding input mode that you want. In this case, press the TV/VIDEO button to switch the input mode of the TV.

## Remote Button Description

www.DataSheet4U.com

Remote Button	Operations	Function
⏸	CD player/ MD deck/Tape deck/VCR/ DVD player/ VCD player/ LD player/ DAT deck	Pauses play or record (Also starts recording with components in record standby.)
■	CD player/ MD deck/Tape deck/VCR/ DVD player/ VCD player/ LD player/ DAT deck	Stops play.
POSITION**	TV	Changes the position of the small picture
SWAP**	TV	Swaps the small and the large picture
DISC	CD player	Select discs (Mega storage CD player only)
SUB CH +/-**	TV	Selects preset channels for the small picture
D SKIP/CH/ PRESET +/-	Receiver	Scans and selects preset stations
	TV/VCR/SAT	Selects preset channels
	CD player	Skips discs (CD player with multi-disc changer only)
DISPLAY	TV/VCR/ LD player/ DVD player/ VCD player	Selects information displayed on the TV screen
P IN P**	TV	Activates the picture-in- picture function
JUMP	TV	Toggles between the previous and the current channels
WIDE	TV	Selects the wide picture mode
ANT TV/VTR	VCR	Selects output signal from the aerial terminal: TV signal or VCR program
TV/VIDEO	TV/VCR	Selects input signal: TV input or video input
A F D	Receiver	Auto Format Decoding
2CH/OFF	Receiver	Turns off sound field or selects 2CH mode
MODE +/-	Receiver	Selects sound field mode
MULTI CH/ 2 CH DIRECT	Receiver	Selects MULTI CH IN source
MUTING	Receiver	Mutes the sound from the receiver

Remote Button	Operations	Function
TEST TONE	Receiver	Press to output test tone
MAIN MENU	Receiver	Press this button repeatedly to select one of the two cursor modes: LEVEL and SURROUND
MASTER VOL +/-	Receiver	Adjusts the master volume of the receiver
MENU </>	Receiver	Selects a menu item
MENU +/-	Receiver	Makes adjustment or change the setting
MENU	DVD player	Displays DVD menu
⏪/⏩/⏴/⏵	DVD player	Selects a menu item
ENTER	DVD player	Enters the selection
RETURN	DVD player	Returns to the previous menu or exits the menu
TITLE	DVD player	Displays DVD title

\*\* Only for Sony TVs with the picture-in-picture function

### Notes

- Some functions explained in this section may not work depending on the model of the receiver
- The above explanation is intended to serve as an example only. Therefore, depending on the component the above operation may not be possible or may operate differently than described
- The VIDEO 1, VIDEO 2, VIDEO 3 and PHONO functions are not available for set operation

## Changing the factory setting of a function button

If the factory settings of the FUNCTION buttons don't match your system components, you can change them. For example, if you have an MD player and a tape deck and you don't have a CD player, you can assign the CD/SACD button to your tape deck.

Note that the settings of the TUNER and FN SHIFT functions (VIDEO 1, VIDEO 2, VIDEO 3, PHONO and MD/TAPE) button cannot be changed.

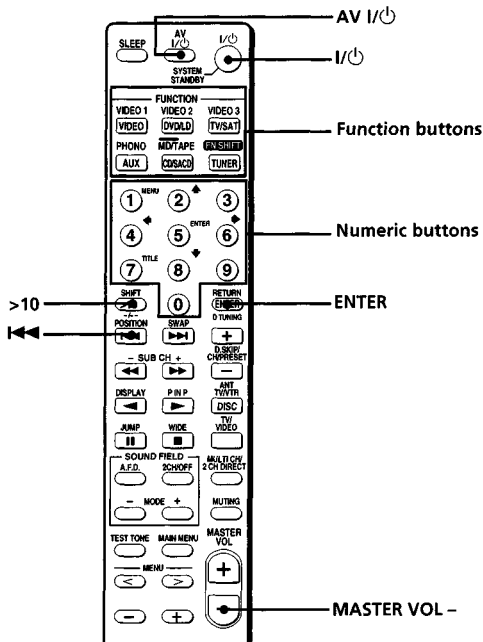

- 1 Hold down the Function button whose function you want to change (for example, CD/SACD)
- 2 Press the corresponding button of the component you want to assign to the Function button (for example, 4 - Tape deck)

The following buttons are assigned to select the functions:

To operate	Press
CD player	1
DAT deck	2
MD deck	3
Tape deck A	4
Tape deck B	5
LD player	6
VCR (remote control mode VTR 1*)	7
VCR (remote control mode VTR 2*)	8
VCR (remote control mode VTR 3*)	9
TV	0
DSS (Digital Satellite Receiver)	>10
DVD	ENTER
VCD player	◀◀

\* Sony VCRs are operated with a VTR 1, 2 or 3 setting. These correspond to Beta, 8mm and VHS respectively.

Now you can use the CD/SACD button to control the tape deck.

**To reset a button to its factory setting**  
Repeat the above procedure

**To reset all the function buttons to their factory setting**  
Press I/O, AV I/O and MASTER VOL - at the same time

## Remote Button Description

www.DataSheet4U.com

### Models of Area Code CA (STR-DE675 and STR-DE575 only) and Models of Area Code U (STR-DE675 only)

You can use the remote RM-PP505 to operate the components in your system. The tables below show the settings of each button.

Remote Button	Operations	Function
SLEEP	Receiver	Activates the sleep function and the duration which the receiver turns off automatically
AV 1/⏻	TV/VCR/ CD player/ DVD player/ MD deck/ VCD player/ LD player/ DAT deck	Turns the audio and video components on or off
I/⏻	Receiver	Turns the receiver on or off
VIDEO 1	Receiver	To watch VCR (VTR mode 3)
VIDEO 2	Receiver	To watch VCR (VTR mode 1) (STR-DE675 only)
DVD/LD	Receiver	To watch DVD or laser disc
TV/SAT	Receiver	To watch TV programs or satellite receiver
AUX	Receiver	To listen to an audio equipment
MD/TAPE	Receiver	To listen to Minidisc or audio tape
CD/SACD	Receiver	To listen to compact disc
TUNER	Receiver	To listen to radio programs
0-9	Receiver	Use with "SHIFT" button to select tuner preset station numeric input during DIRECT TUNING or MEMORY mode
	CD player/ MD deck/ VCD player/ LD player/ DAT deck	Selects track numbers 0 selects track 10
	TV/VCR/SAT	Selects channel numbers
>10	CD player/ MD deck/ Tape deck/ LD player/ VCD player	Selects tracks numbers over 10
/10, /11, /12	TV	Select channel 10, 11 or 12

Remote Button	Operations	Function
ENTER	TV/VCR/SAT/ Tape deck/ LD player/ VCD player/ MD deck/ DAT deck	After selectig a channel, disc or track using the numeric buttons, press to enter the value
SHIFT	Receiver	Press repeatedly to select a memory page for presetting radio stations or tuning to preset stations
D TUNING	Receiver	Tuner station direct key-in mode
⏮/⏭	CD player/ MD deck/ DVD player/ LD player/ VCD player/ Tape deck/VCR/ DAT deck	Skips tracks
⏪/⏩	CD player/ DVD player/ VCD player	Searches tracks (forward or backward)
	MD deck/ Tape deck/VCR/ LD player/ DAT deck	Fastforwards or rewinds
⏪	Tape deck	Starts play on the reverse side
⏩	CD player/ MD deck/Tape deck/VCR/ DVD player/ VCD player/ LD player/ DAT deck	Starts play
⏸	CD player/ MD deck/Tape deck/VCR/ DVD player/ VCD player/ LD player/ DAT deck	Pauses play or record (Also starts recording with components in record standby.)
■	CD player/ MD deck/Tape deck/VCR/ DVD player/ VCD player/ LD player/ DAT deck	Stops play
DISC	CD player	Select discs (Mega storage CD player only)

www.DataSheet4U.com



Remote Button	Operations	Function
D SKIP/CH/ PRESET +/-	Receiver	Scans and selects preset stations
	TV/VCR/SAT	Selects preset channels
	CD player	Skips discs (CD player with multi-disc changer only)
MONITOR	TV	Press to activate TV control buttons Press again to restore original category.
TV/VIDEO	TV/VCR	Selects input signal: TV input or video input
SEARCH MODE	DVD player	Selects searching mode
CLEAR	DVD player	Press if you made a mistake when you press the number button
RETURN (with ◀)	VCD player	Press to go back to the previous menu
WIDE	TV	Selects the wide picture mode
-/--	TV/VCR	Selects the channel entry mode, either one or two digit
ANT TV/VTR	VCR	Selects output signal from the aerial terminal: TV signal or VCR program
JUMP	TV	Toggles between the previous and the current channels
SUB CH +/-*	TV	Selects preset channels for the small picture
VOL +/-	TV	Adjust the volume of TV
POSITION*	TV	Changes the position of the small picture
MUTING (with PAUSE)	TV	Mutes the sound from TV
SWAP*	TV	Swaps the small and the large picture
P IN P*	TV	Activates the picture-in-picture function
INPUT MODE	Receiver	Selects input mode for your digital components
A F D	Receiver	Auto Format Decoding
MODE +/-	Receiver	Selects sound field mode
2CH	Receiver	Selects 2CH mode
PRESET	Receiver	Selects CINEMA STUDIO EX A, B or C

Remote Button	Operations	Function
TEST TONE	Receiver	Press to output test tone
EQ/TONE	Receiver	EQ ON/OFF
MULTI /2CH A DIRECT	Receiver	Selects MULTI CH IN source
MUTING	Receiver	Mutes the sound from the receiver
AV DISPLAY	TV/VCR/ LD player/ DVD player/ VCD player	Selects information displayed on the TV screen
TITLE/GUIDE	DVD player VCR/SAT	Displays DVD title
AV MENU	DVD player VCR/SAT	Displays DVD menu
MAIN MENU	Receiver	Press this button repeatedly to select one of the three cursor modes: LEVEL, SURROUND or EQ
^/v/</>	DVD player VCR/SAT	Selects a menu item
^/v	Receiver	Selects a menu item
</>	Receiver	Makes adjustment or change the setting
ENTER / EXEC	DVD player/ VCR/SAT	Enters the selection
EXIT/RETURN	DVD player VCR/SAT	Returns to the previous menu or exits the menu
MASTER VOL +/-	Receiver	Adjusts the master volume of the receiver

\* Only for Sony TVs with the picture-in-picture function

#### Notes

- Some functions explained in this section may not work depending on the model of the receiver
- The above explanation is intended to serve as an example only. Therefore, depending on the component the above operation may not be possible or may operate differently than described
- The VIDEO 3, PHONO, AV1, AV2, 3RD, NIGHT MODE, ON SCREEN, 2ND ROOM and AUDIO SPLIT functions are not available for set operation

### Programming the remote

You can program the remote to control non-Sony components by changing the code. Once the control signals have been memorized, you can use those components as part of your system. Furthermore, you can also program the remote for Sony components that the remote is unable to control. Note that the remote can only control components that accept infrared wireless control signals.

**Note**

When you assign a component to the MONITOR button, you can operate the programmed component without changing the function of the receiver.

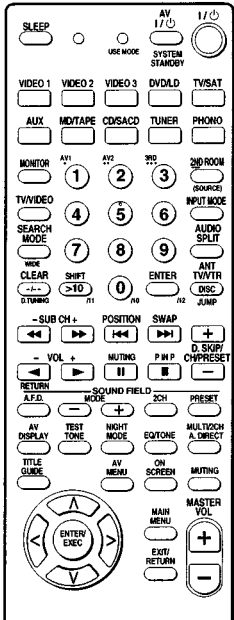

- 3 Press the numeric buttons to enter the numeric code (or one of the codes if more than one code exists) corresponding to the component and the maker of the component you want to control**  
See the tables on pages 59 and 60 for information on the numeric code(s) corresponding to the component and the maker of the component (the first digit and the last two digits of the numeric code correspond to the category and the maker's code respectively)
- 4 Press ENTER**  
Once the numeric code has been verified, the indicator slowly flashes twice and the remote automatically exits the programming mode
- 5 Repeat steps 1 to 4 to control other components**

**To cancel programming**

Press USE MODE during any step. The remote automatically exits the programming mode.

**To activate the function after programming**  
Press the programmed button to activate the function you want.

**If programming is unsuccessful, check the following:**

- If the indicator does not light up in step 1, the batteries are weak. Replace both batteries.
- If the indicator flashes 4 times in quick succession while entering the numeric code, an error has occurred. Start again from step 1.

**Notes**

- The indicator turns off while a valid button is pressed.
- In step 2, if several function buttons are pressed, only the last pressed button is valid.
- In step 3, if a function button is pressed, the new function is selected and the programming procedure returns to the beginning of step 3.
- For the numeric codes, only the first three numbers entered are valid.

- 1 Press AV I/O while pressing down USE MODE**  
The indicator lights
- 2 Press the function button (including MONITOR) for the component you want to control**  
For example, if you are going to control a CD player, press CD

Additional Information

**To clear the memory of the remote**

To clear all programmed and learned signals, do the following to reset the remote to factory settings

**Press I/⏪, AV I/⏪ and MASTER VOL – at the same time**

The indicator flashes 3 times, then goes off

**The numeric codes corresponding to the component and the maker of the component**

Use the numeric codes in the tables below to control non-Sony components and also Sony components that the remote is normally unable to control. Since the remote signal that a component accepts differs depending on the model and year of the component, more than one numeric code may be assigned to a component. If you fail to program your remote using one of the codes, try using other codes.

**Notes**

- The numeric codes are based on the latest information available for each brand. There is a chance, however, that your component will not respond to some or all of the codes.
- All of the functions on this remote may not be available when used with your particular component.

**To control a CD player**

Maker	Code(s)
SONY	101, 102, 103
DENON	104, 123
JVC	105, 106, 107
KENWOOD	108, 109, 110
MAGNAVOX	111, 116
MARANTZ	116
ONKYO	112, 113, 114
PANASONIC	115
PHILIPS	116
PIONEER	117
TECHNICS	115, 118, 119
YAMAHA	120, 121, 122

**To control a DAT deck**

Maker	Code(s)
SONY	203
PIONEER	219

**To control an MD deck**

Maker	Code(s)
SONY	301
DENON	302
JVC	303
KENWOOD	304

**To control a tape deck**

Maker	Code(s)
SONY	201, 202
DENON	204, 205
KENWOOD	206, 207, 208, 209
NAKAMICHI	210
PANASONIC	216
PHILIPS	211, 212
PIONEER	213, 214
TECHNICS	215, 216
YAMAHA	217, 218

**To control an LD player**

Maker	Code(s)
SONY	601, 602, 603
PIONEER	606

**To control a video CD player**

Maker	Code(s)
SONY	605

## Remote Button Description

www.DataSheet4U.com

### To control a VCR

Maker	Code(s)
SONY	701, 702, 703, 704, 705, 706
AIWA	710, 750, 757, 758
AKAI	707, 708, 709, 759
BLAUPUNKT	740
EMERSON	711, 712, 713, 714, 715, 716, 750
FISHER	717, 718, 719, 720
GENERAL ELECTRIC	721, 722, 730
GOLDSTAR	723, 753
GRUNDIG	724
HITACHI	722, 725, 729, 741
ITT/NOKIA	717
JVC	726, 727, 728, 736
MAGNAVOX	730, 731, 738
MINISUBISHI/MGA	732, 733, 734, 735
NEC	736
PANASONIC	729, 730, 737, 738, 739, 740
PHILIPS	729, 730, 731
PIONEER	729
RCA/PROSCAN	722, 729, 730, 731, 741, 747
SAMSUNG	742, 743, 744, 745
SANYO	717, 720, 746
SHARP	748, 749
TELEFUNKEN	751, 752
TOSHIBA	747, 755, 756
ZENITH	754

### To control a DVD player

Maker	Code(s)
SONY	401
PANASONIC	402, 406
PHILIPS	407
PIONEER	403
TOSHIBA	404
DENON	405

### To control a TV

Maker	Code(s)
SONY	501
DAEWOO	504, 505, 506, 507, 515, 544
FISHER	508
GOLDSTAR	503, 511, 512, 515, 534, 544
GRUNDIG	517, 534
HITACHI	513, 514, 515, 544
ITT/NOKIA	521, 522
JVC	516
MAGNAVOX	503, 518, 544
MINISUBISHI/MGA	503, 519, 544
NEC	503, 520, 544
PANASONIC	509, 524
PHILIPS	515, 518
PIONEER	509, 525, 526, 540
RCA/PROSCAN	510, 527, 528, 529, 544
SAMSUNG	503, 515, 531, 532, 533, 534, 544
SANYO	508, 545
SHARP	535
TELEFUNKEN	523, 536, 537, 538
THOMSON	530, 537, 539
TOSHIBA	535, 540, 541
ZENITH	542, 543

### To control a satellite tuner or cable box

Maker	Code(s)
SONY	801, 802, 803
JERROLD/G I	806, 807, 808, 809, 810, 811, 812, 813, 814
PANASONIC	818
RCA	804, 805
S ATLANTA	815, 816, 817

**A**

- AC-3 *See Dolby Digital (AC-3)*
- Adjusting
  - brightness of the display 23
  - speaker volumes 20
  - surround parameters 34
- Automatic tuning 40

**B**

- Basic receiver operations 23–26
- Batteries 4

**C**

- Changing
  - display 23
  - effect level 34
- Checking the connections 21
- Clearing receiver's memory 16
- Connecting *See Hookups*
- CONTROL A1 II 11, 45
- Customizing sound fields 36

**D**

- Demonstration mode 16
- Digital Cinema Sound 51
- Direct tuning 40
- Dolby Digital (AC-3) 51
- Dolby Pro Logic Surround 51
- Dubbing *See Recording*

**E, F, G**

- Editing *See Recording*
- Effect level 34

**H**

- Hookups
  - MULTI CH IN Input 10
  - AC power cord 11
  - antennas 5
  - audio components 6
  - digital components 8
  - CONTROL A1 II 11
  - speaker system 14
  - video components 7

**I, J, K**

- Indexing *See Naming*

**L, M**

- Labeling *See Naming*

**N, O**

- Naming
  - preset stations 43
  - program sources 43

**P, Q**

- Parameter 34, 36
- Preset stations
  - how to preset 41
  - how to tune 40
- Preset tuning 41

**R**

- Receiving broadcasts
  - automatically 40
  - directly 40
  - preset stations 41
- Recording
  - on an audio tape or MD 43
  - on a video tape 44

**S**

- Scanning
  - preset stations *See Preset tuning*
  - radio stations *See Automatic tuning*
- Selecting
  - component 25
  - sound field 28
- Sleep timer 44
- Sound field
  - adjustable parameters 34
  - customizing 34
  - pre-programmed 28–31
  - resetting 36
  - selecting 28

**Speakers**

- adjusting speaker volume 20
- connection 14
- placement 17
- Supplied accessories 4
- Surround sound 27–37,

**T**

- Test tone 20
- Troubleshooting 47
- Tuning
  - automatically 40
  - directly 40
  - preset stations 41

**U, V, W, X, Y, Z**

- Unpacking 4



**SONY®**General Stereo/Hifi Components/Tape Decks  
CD Players/Mini Disc Players/Audio Systems

# LIMITED WARRANTY

Hifi Audio

Sony Electronics Inc. ("Sony") warrants this Product (including any accessories) against defects in material or workmanship as follows:

1 **LABOR:** For a period of two (2) year from the date of purchase, if this Product is determined to be defective, Sony will repair or replace the Product, at its option, at no charge, or pay the labor charges to any Sony authorized service facility. After the Warranty Period, you must pay for all labor charges.

2 **PARTS:** In addition, Sony will supply, at no charge, new or rebuilt replacements in exchange for defective parts for a period of two (2) year. After the warranty period, you must pay for all parts costs.

3 **ACCESSORIES:** Parts and labor for all accessories are for one (1) year.

To obtain warranty service, you must take the Product, or deliver the Product freight prepaid, in either its original packaging or packaging affording an equal degree of protection, to any authorized Sony service facility.

This warranty does not cover customer instruction, installation, set up adjustments or signal reception problems.

This warranty does not cover cosmetic damage or damage due to acts of God, accident, misuse, abuse, negligence, commercial use, or modification of, or to any part of the Product, including the antenna. This warranty does not cover damage due to improper operation or maintenance, connection to improper voltage supply, or attempted repair by anyone other than a facility authorized by Sony to service the Product. This warranty does not cover Products sold AS IS or WITH ALL FAULTS, or consumables (such as fuses or batteries). This warranty is valid only in the United States.

Proof of purchase in the form of a bill of sale or receipted invoice which is evidence that the unit is within the Warranty period must be presented to obtain warranty service.

This warranty is invalid if the factory applied serial number has been altered or removed from the Product.

**REPAIR OR REPLACEMENT AS PROVIDED UNDER THIS WARRANTY IS THE EXCLUSIVE REMEDY OF THE CONSUMER. SONY SHALL NOT BE LIABLE FOR ANY INCIDENTAL OR CONSEQUENTIAL DAMAGES FOR BREACH OF ANY EXPRESS OR IMPLIED WARRANTY ON THIS PRODUCT EXCEPT TO THE EXTENT PROHIBITED BY APPLICABLE LAW, ANY IMPLIED WARRANTY OF MERCHANTABILITY OR FITNESS FOR A PARTICULAR PURPOSE ON THIS PRODUCT IS LIMITED IN DURATION TO THE DURATION OF THIS WARRANTY.**

Some states do not allow the exclusion or limitation of incidental or consequential damages, or allow limitations on how long an implied warranty lasts, so the above limitations or exclusions may not apply to you. In addition, if you enter into a service contract with the Sony Partnership within 90 days of the date of sale, the limitation on how long an implied warranty lasts does not apply to you. This warranty gives you specific legal rights, and you may have other rights which vary from state to state.

For your convenience, Sony Electronics Inc. has established telephone numbers for frequently asked questions:

To locate the servicer or dealer nearest you, or for service assistance or resolution of a service problem, or for product information or operation, call:

**Sony Direct Response Center**

1-(800)-222-7669

or write to:

Sony Direct Response Center

12451 Gateway Blvd

Fort Myers, FL 33913

For an accessory or part not available from your authorized dealer, call:

1-(800)-488-SONY (7669)

[www.DataSheet4U.com](http://www.DataSheet4U.com)

## Correct/Correct/Correcto/Correcto/ Corretto/Richtig/Juist/Rätt

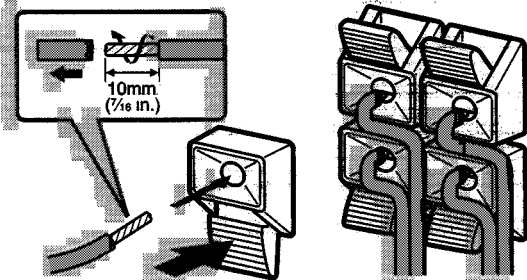

Remove about 10 mm ( $\frac{3}{16}$  in.) of insulation at the end of the cord, then twist the exposed wires. Connect the stripped ends of the cords to the terminals, taking care to avoid mutual contact between the cords.



## Incorrect/Incorrect/ Incorrecto/Incorrecto/Errato/ Falsch/Onjuist/Fel

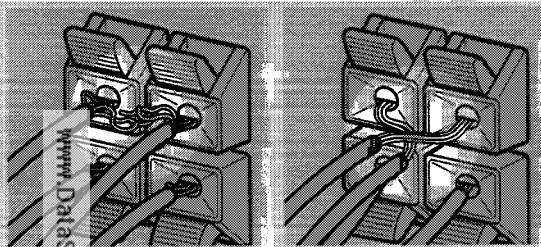

Stripped speaker cord touching another speaker terminal.

Stripped ends of speakers cords in contact with other due to excessive removal of insulation.

Make sure the cords are firmly connected to the speaker and receiver (or amplifier) terminals.

## To avoid short-circuiting the speaker cords

A short-circuit in the speaker cords will mute the speakers, and may even damage the receiver (or amplifier). To prevent this, refer to the left illustration and connect the cords correctly. When connecting the stripped ends of the speaker cords, make sure the ends do not touch each other or neighboring terminals.

## Pour éviter un court-circuit des cordons d'enceintes

Un court-circuit des cordons d'enceintes aura pour effet de couper le son des enceintes et peut endommager l'ampli-tuner (ou l'amplificateur). Pour éviter de ce problème, consultez l'illustration de gauche et raccordez correctement les cordons. Lorsque vous insérez les extrémités dénudées des cordons d'enceintes, assurez-vous qu'elles ne se touchent pas et qu'elles ne sont pas en contact avec les bornes voisines.

## Para evitar el cortocircuito de los altavoces

Un cortocircuito de los cables de altavoces puede apagar el sonido de los altavoces y puede incluso dañar el sintonizador (o amplificador). Para evitarlo, consulte la figura de la izquierda y conecte correctamente los cables. Cuando conecte las puntas despeladas de los cables de altavoz, asegúrese de que las puntas no se tocan entre sí u otros terminales vecinos.

## Para evitar que os cabos de altifalante entrem em curto-circuito

Um curto-circuito dos cabos de altifalante emudecerá os altifalantes e ainda poderia causar danos ao receptor (ou amplificador). Para evitar isso, observe a ilustração à esquerda e efetue a ligação dos cabos correctamente. Ao conectar a extremidade descascada dos cabos de altifalante, certifique-se de que cada uma delas não toque na outra nem nos terminais próximos.

## Per evitare di cortocircuitare i cavi diffusori

Un cortocircuito nei cavi diffusori silenzia l'emissione del suono dai diffusori, e potrebbe persino danneggiare il ricevitore (o l'amplificatore). Per evitare ciò, fare riferimento all'illustrazione a sinistra e collegare i cavi correttamente. Quando si collegano i capi denudati dei cavi diffusori, accertarsi che le estremità non si tocchino l'una con l'altra e che non tocchino i terminali vicini.

## Um ein Kurzschließen der Lautsprecher zu vermeiden

Ein Kurzschließen der Lautsprecherkabel kann die Lautsprecher stummschalten und sogar den Receiver (oder Verstärker) beschädigen. Um dies zu vermeiden, beachten Sie bitte beim Anschließen der Lautsprecher die Abbildung links. Sicherstellen, daß die abisolierten Enden der Lautsprecherkabel nicht mit den abisolierten Enden anderer Lautsprecherkabel oder der falschen Lautsprecherklemme in Berührung kommen.

## Om kortsluiting in de luidspreker aansluitingen te voorkomen

Kortsluiting in de luidspreker aansluitingen kan resulteren in wegvallend geluid en eventueel zelfs schade aan de tuner/versterker (of versterker) toebrengen. Om dit te voorkomen, volgt u de links getoonde aanwijzingen voor het aansluiten van de luidsprekersnoeren. Let op dat de gestripte uiteinden van de luidsprekerdraden elkaar niet raken; laat ze niet zover uitsteken dat ze kortsluiting met andere aansluitpunten kunnen maken.

## För att undvika att högtalarkablarna kortslots

Om högtalarkablarna kortslots försvinner ljudet ur högtalarna och det finns risk att receptorn (eller förstärkaren) skadas. Var noga med att ansluta högtalarkablarna på rätt sätt enligt figuren till vänster för att förhindra detta. Kontrollera när du sätter i de avskalade ändarna av högtalarkablarna att ändarna inte kommer i kontakt med varandra eller med något annat högtalaruttag.



**SONY®**

# **IMPORTANT SAFEGUARDS**

**For your protection, please read these safety instructions completely before operating the appliance, and keep this manual for future reference.**

**Carefully observe all warnings, precautions and instructions on the appliance and in the operating instructions, and adhere to them.**

www.DataSheet4U.com

www.DataSheet4U.com