



Description

The STR8042 is a bi-directional, single-pole, single-throw, normally open multipurpose relay. The device consists of an IR LED optically coupled to a random phase switching AC output structure. It has a high blocking voltage (400V) and can handle continuous load currents of up to 0.8A_{RMS}. The STR8042 assures no false triggering under adverse conditions.

The STR8042 comes standard in a compact 8 pin DIP package. The package construction makes it ideal for high-density board applications.

Applications

- Valve Control
- Meter Reading Systems
- Heating Elements
- Home Appliances
- Solenoid / Motor Control
- Dimmer Control

Schematic Diagram

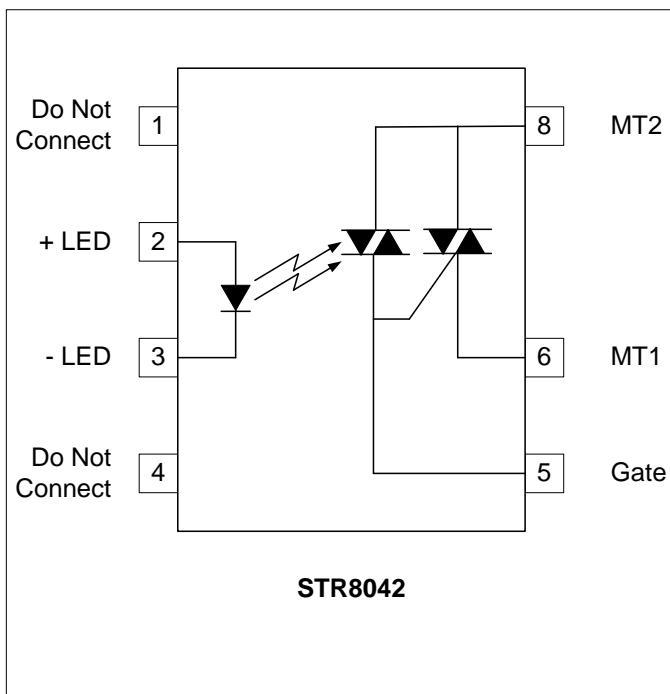

Features

- High Blocking Voltage (400V)
- 0.8A_{RMS} Continuous Load Current
- Random Phase Switching
- Low Control Current (<10mA)
- High Isolation Voltage (up to 5kV_{RMS})
- Long Life / High Reliability
- RoHS / Pb-Free / REACH Compliant

Agency Approvals

- UL
- C-UL

Absolute Maximum Ratings

The values indicated are absolute stress ratings. Functional operation of the device is not implied at these or any conditions in excess of those defined in electrical characteristics section of this document. Exposure to absolute Maximum Ratings may cause permanent damage to the device and may adversely affect reliability.

Storage Temperature	-55 to +125°C
Operating Temperature	-40 to +85°C
Continuous Input Current	50mA
Transient Input Current	500mA
Reverse Input Control Voltage	5V
Input Power Dissipation	40mW
Output Power Dissipation	800mW
Solder Temperature – Wave (10sec).....	260°C
Solder Temperature – IR Reflow (10sec).....	260°C

Ordering Information

Part Number	Description
STR8042	8 pin DIP, (50/Tube)
STR8042-H	5kV _{RMS} Viso, 8 pin DIP, (50/Tube)
STR8042-S	8 pin SMD, (50/Tube)
STR8042-HS	5kV _{RMS} , 8 pin SMD, (50/Tube)
STR8042-STR	8 pin SMD, Tape and Reel (1000/Reel)
STR8042-HSTR	5kV _{RMS} , 8 pin SMD, Tape and Reel (1000/Reel)

NOTE: Suffixes listed above are not included in marking on device for part number identification

Electrical Characteristics, $T_A = 25^\circ\text{C}$ (unless otherwise specified)

Parameter	Symbol	Min.	Typ.	Max.	Units	Test Conditions
Input Specifications						
LED Forward Voltage	V_F	-	1.4	1.8	V	$I_F = 10\text{mA}$
LED Reverse Voltage	BV_R	5	-	-	V	$I_R = 10\mu\text{A}$
Trigger Current ¹	I_{FT}	-	-	10	mA	Resistive Load
Output Specifications						
Peak Off-State Voltage	V_{DRM}	400	-	-	V	$I_{DRM}=10\mu\text{A}$
Continuous Load Current	$I_{T(RMS)}$	-	-	0.8	A	$I_{FT}=10\text{mA}$
Peak On-State Voltage	V_{TM}	-	1.3	2.5	V	$I_{FT}=10\text{mA}$, $I_T=800\text{mA}$
Leakage Current	I_{DRM}	-	10	100	μA	$I_{FT}=0\text{mA}$, $V_{DRM}=400\text{V}$
Holding Current	I_H	-	5	25	mA	$I_{FT}=10\text{mA}$
Critical Rate of Rise (dV//dt)	dV_D/dt	-	-	400	V/ μS	$V_{DM}=67\%$ 400V
Isolation Specifications						
Isolation Voltage (-H Option)	V_{ISO}	3750	-	-	V_{RMS}	RH \leq 50%, t=1min
		5000	-	-		
Input-Output Resistance	R_{I-O}	-	10^{12}	-	Ω	$V_{I-O} = 500V_{DC}$

Notes:

- 1) $I_{FT} = 20\text{mA}$ recommended for inductive loads

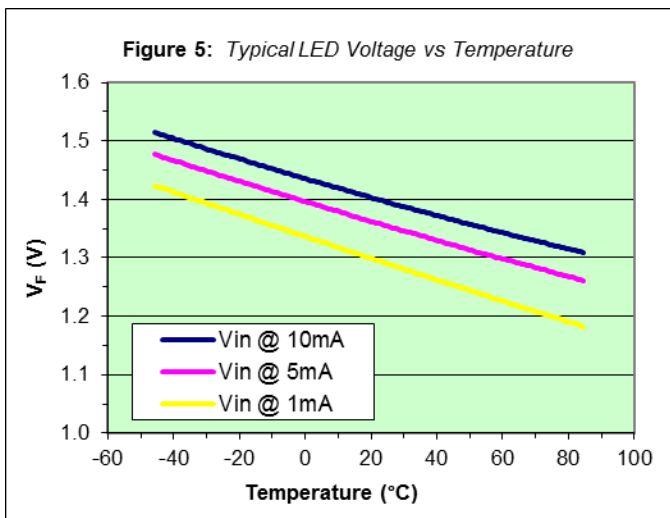
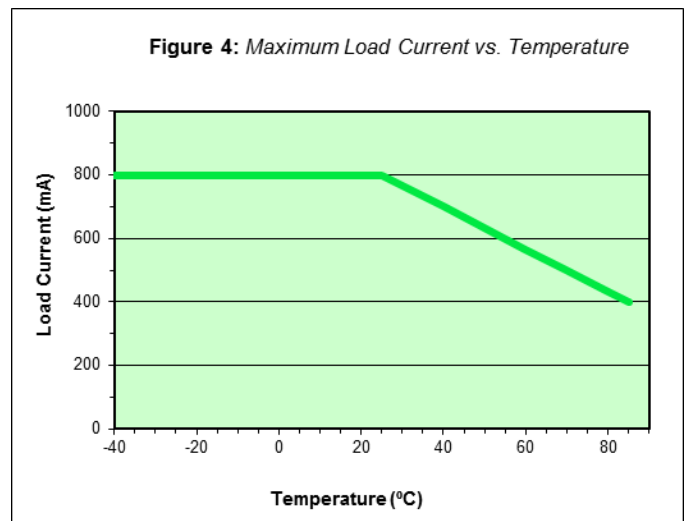
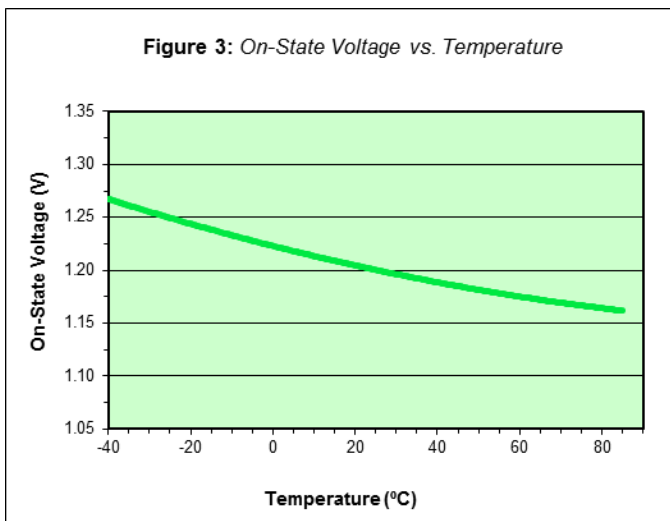
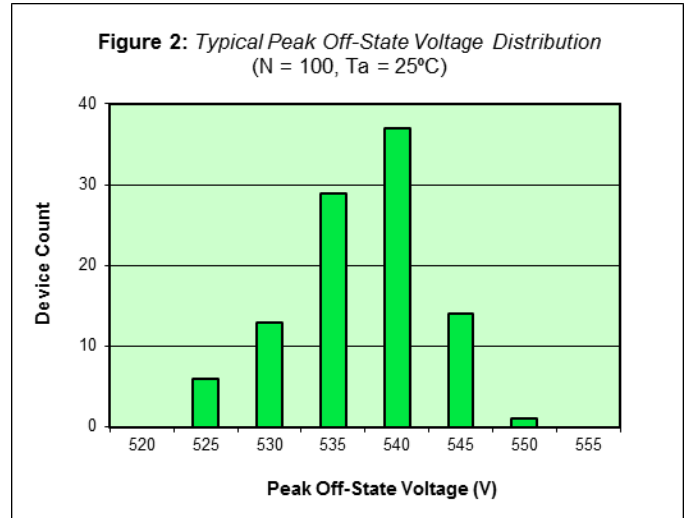
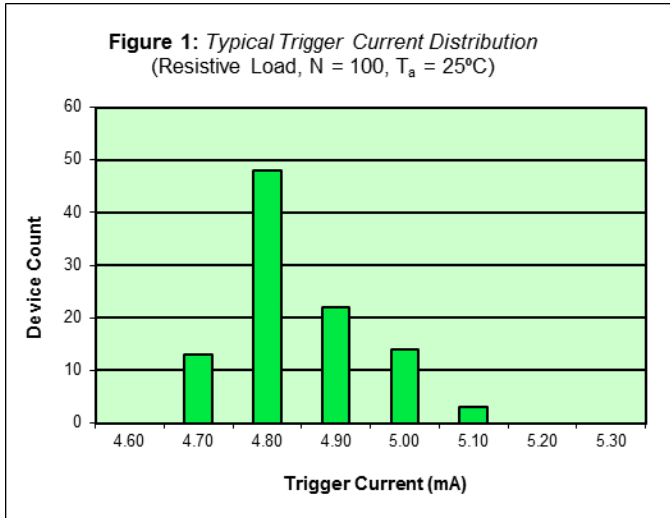
STR8042 Performance & Characteristics Plots, $T_A = 25^\circ\text{C}$ (unless otherwise specified)

STR8042 Solder Temperature Profile Recommendations
(1) Infrared Reflow:

Refer to the following figure as an example of an optimal temperature profile for single occurrence infrared reflow. Soldering process should not exceed temperature or time limits expressed herein. Surface temperature of device package should not exceed 250°C:

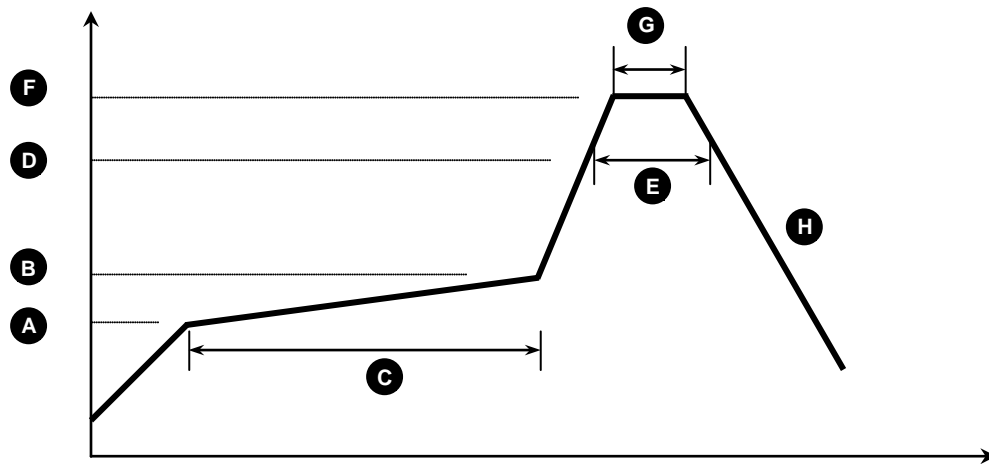

Figure 1

Process Step	Description	Parameter
A	Preheat Start Temperature (°C)	150°C
B	Preheat Finish Temperature (°C)	180°C
C	Preheat Time (s)	90 - 120s
D	Melting Temperature (°C)	230°C
E	Time above Melting Temperature (s)	30s
F	Peak Temperature, at Terminal (°C)	260°C
G	Dwell Time at Peak Temperature (s)	10s
H	Cool-down (°C/s)	<6°C/s

(2) Wave Solder:

Maximum Temperature: 260°C (at terminal)
 Maximum Time: 10s
 Pre-heating: 100 - 150°C (30 - 90s)
 Single Occurrence

(3) Hand Solder:

Maximum Temperature: 350°C (at tip of soldering iron)
 Maximum Time: 3s
 Single Occurrence

STR8042 Package Dimensions

8 PIN DIP Package

Note: All dimensions in inches ["] with millimeters in parenthesis ()

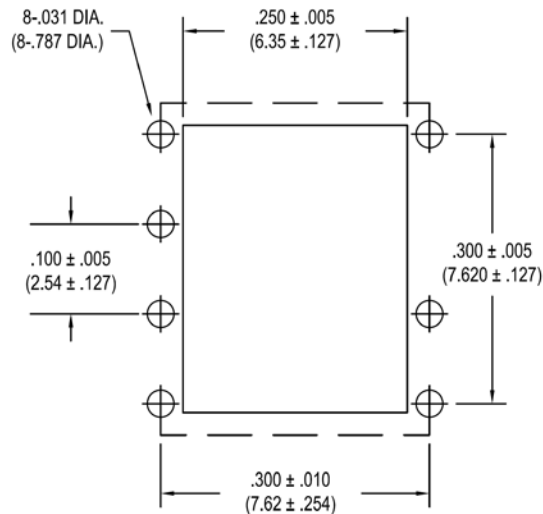
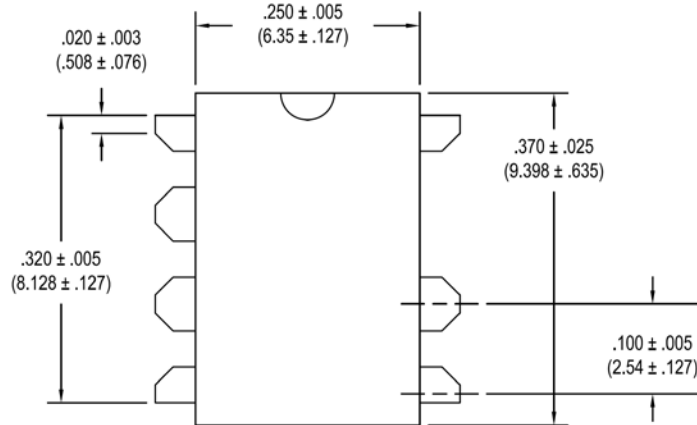
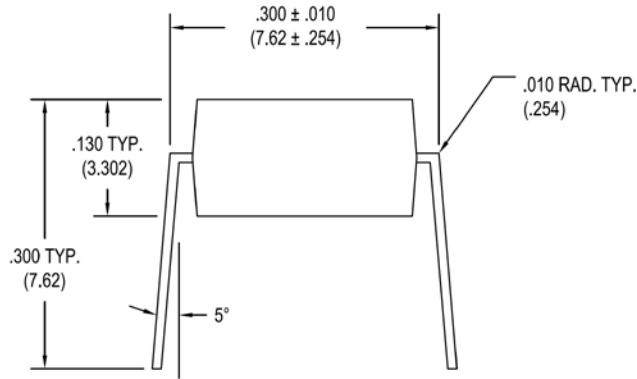

STR8042 Package Dimensions

8 PIN SMD Surface Mount Package (-S)

Note: All dimensions in inches ["] with millimeters in parenthesis ()

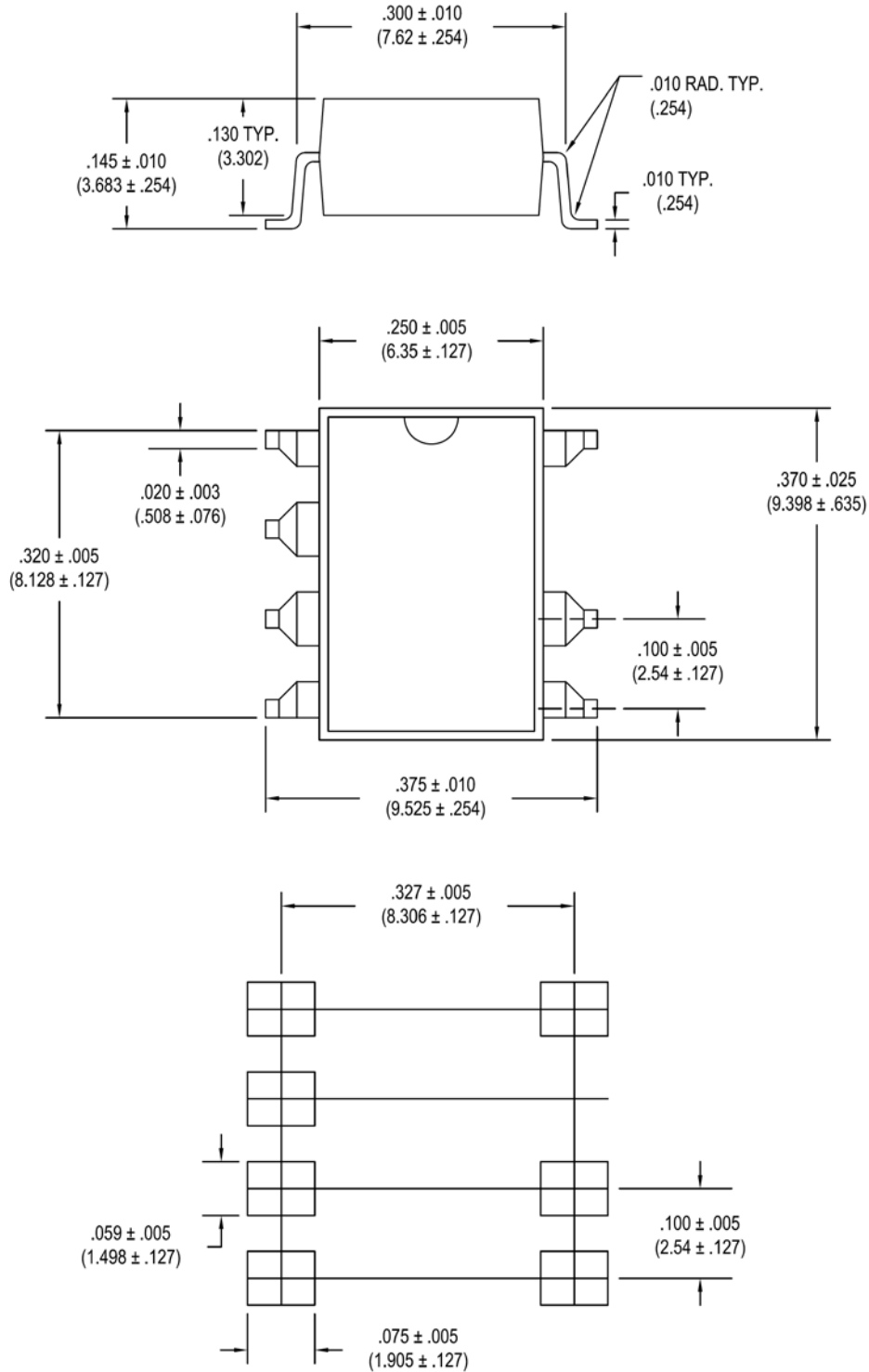

STR8042 Package Dimensions

8 PIN SMD Tape & Reel (-STR)

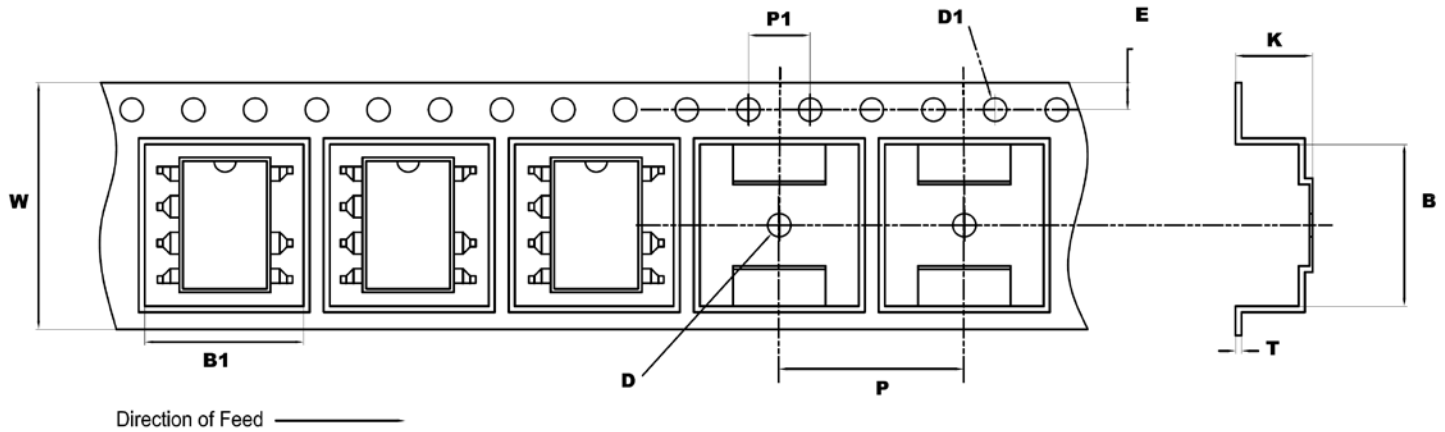
Note: All dimensions in millimeters
Outline and Dimension (Tape)

W	B	B1	P	P1	K	E	T	D	D1
16.00 ±0.1	10.50 ±0.1	10.30 ±0.1	12.00 ±0.1	4.00 ±0.1	5.00 ±0.1	1.75 ±0.1	0.40 ±0.1	1.50 ±0.1	1.50 ±0.1

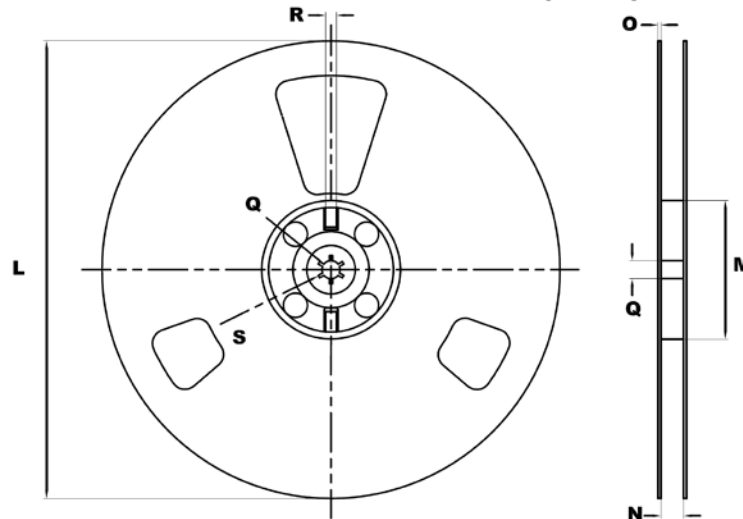
Outline and Dimensions (Reel)

Packaging: 1,000 pcs / reel

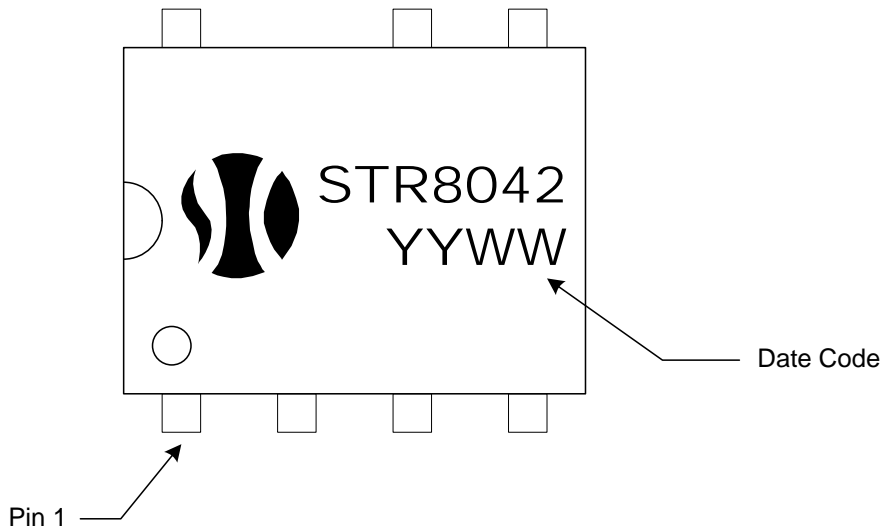
L	M	N	O	Q	R	S
330.00	100.00	16.40 +0.2	2.00 ±0.1	13.00 ±0.2	2.00	10.00

STR8042 Package Marking

STR8042 Package Weights

Device	Single Unit	Full Tube (50pcs)	Full Pouch (10 tubes)	Full Reel (1000pcs)
STR8042-(H)	0.54	42	420	-
STR8042-(H)S	0.53	44	440	-
STR8042-(H)STR	0.53	-	-	950

Note: All weights above are in GRAMS, and include packaging materials where applicable

DISCLAIMER

Solid State Optronics (SSO) makes no warranties or representations with regards to the completeness and accuracy of this document. SSO reserves the right to make changes to product description, specifications at any time without further notices. SSO shall not assume any liability arising out of the application or use of any product or circuit described herein. Neither circuit patent licenses nor indemnity are expressed or implied. Except as specified in SSO's Standard Terms & Conditions, SSO disclaims liability for consequential or other damage, and we make no other warranty, expressed or implied, including merchantability and fitness for particular use.

LIFE SUPPORT POLICY

SSO does not authorize use of its devices in life support applications wherein failure or malfunction of a device may lead to personal injury or death. Users of SSO devices in life support applications assume all risks of such use and agree to indemnify SSO against any and all damages resulting from such use. Life support devices are defined as devices or systems which, (a) are intended for surgical implant into the body, or (b) support or sustain life, and (c) whose failure to perform when used properly in accordance with instructions for use can be reasonably expected to result in significant injury to the user, or (d) a critical component of a life support device or system whose failure can be reasonably expected to cause failure of the life support device or system, or to affect its safety or effectiveness.