



STU16NC50

N-CHANNEL 500V - 0.22Ω - 16A Max220

PowerMesh™II MOSFET

TYPE	V _{DSS}	R _{DS(on)}	I _D
STU16NC50	500V	< 0.27Ω	16 A

- TYPICAL R_{DS(on)} = 0.22Ω
- EXTREMELY HIGH dv/dt CAPABILITY
- 100% AVALANCHE TESTED
- NEW HIGH VOLTAGE BENCHMARK
- GATE CHARGE MINIMIZED

DESCRIPTION

The PowerMESH™II is the evolution of the first generation of MESH OVERLAY™. The layout refinements introduced greatly improve the Ron*area figure of merit while keeping the device at the leading edge for what concerns switching speed, gate charge and ruggedness.

APPLICATIONS

- HIGH CURRENT, HIGH SPEED SWITCHING
- UNINTERRUPTIBLE POWER SUPPLIES (UPS)
- DC-AC CONVERTERS FOR TELECOM, INDUSTRIAL, AND LIGHTING EQUIPMENT

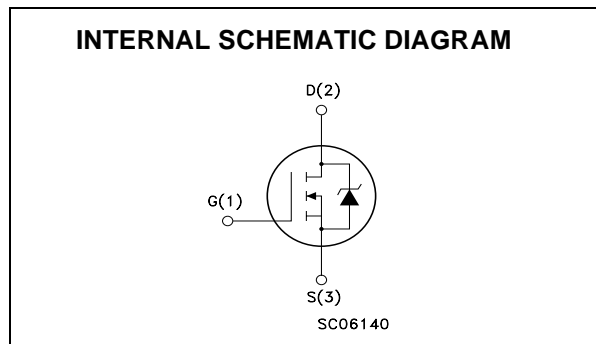
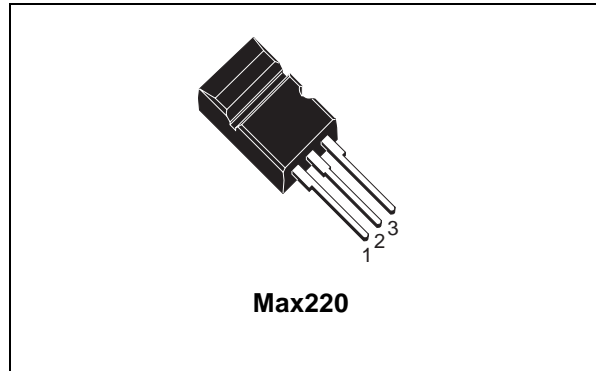

ABSOLUTE MAXIMUM RATINGS

Symbol	Parameter	Value	Unit
V _{DS}	Drain-source Voltage (V _{GS} = 0)	500	V
V _{DGR}	Drain-gate Voltage (R _{GS} = 20 kΩ)	500	V
V _{GS}	Gate- source Voltage	±30	V
I _D	Drain Current (continuous) at T _C = 25°C	16	A
I _D	Drain Current (continuous) at T _C = 100°C	10	A
I _{DM} (●)	Drain Current (pulsed)	64	A
P _{TOT}	Total Dissipation at T _C = 25°C	160	W
	Derating Factor	1.28	W/°C
dv/dt(1)	Peak Diode Recovery voltage slope	3	V/ns
T _{stg}	Storage Temperature	-65 to 150	°C
T _j	Max. Operating Junction Temperature	150	°C

(●)Pulse width limited by safe operating area

(1)I_{SD} ≤ 16A, di/dt ≤ 100A/μs, V_{DD} ≤ V_{(BR)DSS}, T_j ≤ T_{JMAX}.

STU16NC50

THERMAL DATA

Rthj-case	Thermal Resistance Junction-case Max	0.78	°C/W
Rthj-amb	Thermal Resistance Junction-ambient Max	62.5	°C/W
T _l	Maximum Lead Temperature For Soldering Purpose	300	°C

AVALANCHE CHARACTERISTICS

Symbol	Parameter	Max Value	Unit
I _{AR}	Avalanche Current, Repetitive or Not-Repetitive (pulse width limited by T _j max)	16	A
E _{AS}	Single Pulse Avalanche Energy (starting T _j = 25 °C, I _D = I _{AR} , V _{DD} = 50 V)	1000	mJ

ELECTRICAL CHARACTERISTICS (TCASE = 25 °C UNLESS OTHERWISE SPECIFIED)

OFF

Symbol	Parameter	Test Conditions	Min.	Typ.	Max.	Unit
V _{(BR)DSS}	Drain-source Breakdown Voltage	I _D = 250 μA, V _{GS} = 0	500			V
I _{DSS}	Zero Gate Voltage Drain Current (V _{GS} = 0)	V _{DS} = Max Rating V _{DS} = Max Rating, T _C = 125 °C			1 50	μA μA
I _{GSS}	Gate-body Leakage Current (V _{DS} = 0)	V _{GS} = ±30V			±100	nA

ON (1)

Symbol	Parameter	Test Conditions	Min.	Typ.	Max.	Unit
V _{GS(th)}	Gate Threshold Voltage	V _{DS} = V _{GS} , I _D = 250 μA	2	3	4	V
R _{DS(on)}	Static Drain-source On Resistance	V _{GS} = 10V, I _D = 9A		0.22	0.27	Ω

DYNAMIC

Symbol	Parameter	Test Conditions	Min.	Typ.	Max.	Unit
g _{fs}	Forward Transconductance	V _{DS} > I _{D(on)} × R _{DS(on)max} , I _D = 9A		18		S
C _{iss}	Input Capacitance	V _{DS} = 25V, f = 1 MHz, V _{GS} = 0		2980		pF
C _{oss}	Output Capacitance			410		pF
C _{rss}	Reverse Transfer Capacitance			58		pF

ELECTRICAL CHARACTERISTICS (CONTINUED)

SWITCHING ON

Symbol	Parameter	Test Conditions	Min.	Typ.	Max.	Unit
$t_{d(on)}$	Turn-on Delay Time	$V_{DD} = 250V, I_D = 10 A$ $R_G = 4.7\Omega, V_{GS} = 10V$ (see test circuit, Figure 3)		29		ns
t_r	Rise Time			21		ns
Q_g	Total Gate Charge	$V_{DD} = 400V, I_D = 20 A,$ $V_{GS} = 10V$		95	128	nC
Q_{gs}	Gate-Source Charge			14.7		nC
Q_{gd}	Gate-Drain Charge			41.7		nC

SWITCHING OFF

Symbol	Parameter	Test Conditions	Min.	Typ.	Max.	Unit
$t_{r(Voff)}$	Off-voltage Rise Time	$V_{DD} = 400V, I_D = 20 A,$ $R_G = 4.7\Omega, V_{GS} = 10V$ (see test circuit, Figure 5)		14		ns
t_f	Fall Time			30		ns
t_c	Cross-over Time			58		ns

SOURCE DRAIN DIODE

Symbol	Parameter	Test Conditions	Min.	Typ.	Max.	Unit
I_{SD}	Source-drain Current				16	A
$I_{SDM}^{(2)}$	Source-drain Current (pulsed)				64	A
$V_{SD}^{(1)}$	Forward On Voltage	$I_{SD} = 18.4 A, V_{GS} = 0$			1.6	V
t_{rr}	Reverse Recovery Time	$I_{SD} = 20 A, di/dt = 100A/\mu s,$ $V_{DD} = 100V, T_j = 150^\circ C$ (see test circuit, Figure 5)		480		ns
Q_{rr}	Reverse Recovery Charge			5		μC
I_{RRM}	Reverse Recovery Current			21		A

Note: 1. Pulsed: Pulse duration = 300 μs , duty cycle 1.5 %.
2. Pulse width limited by safe operating area.

Safe Operating Area

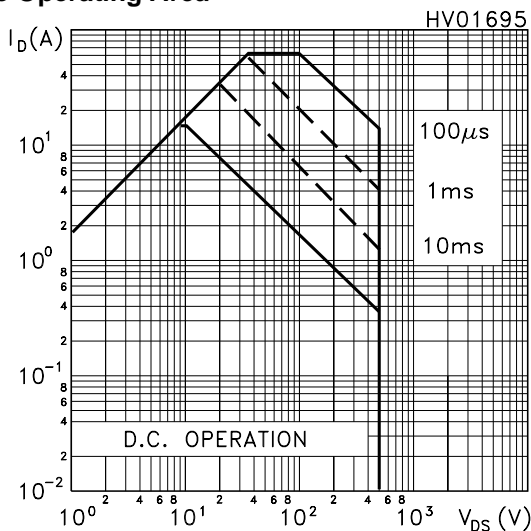

Thermal Impedance

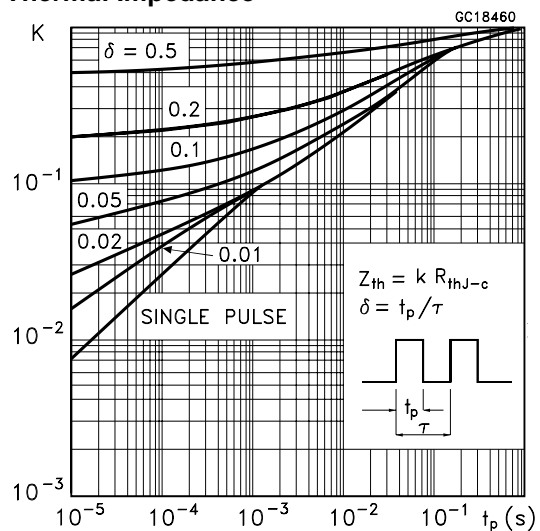

Output Characteristics

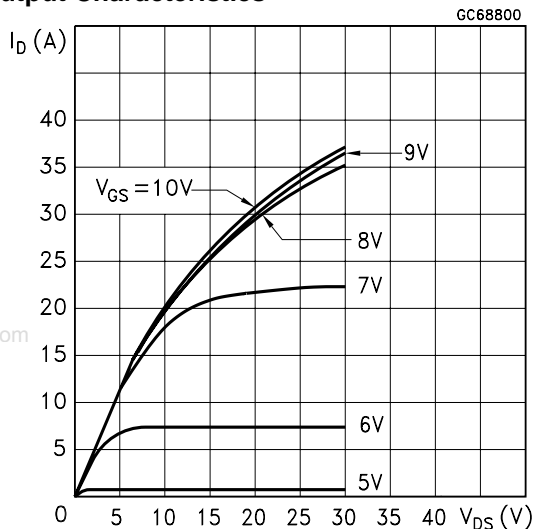

Transfer Characteristics

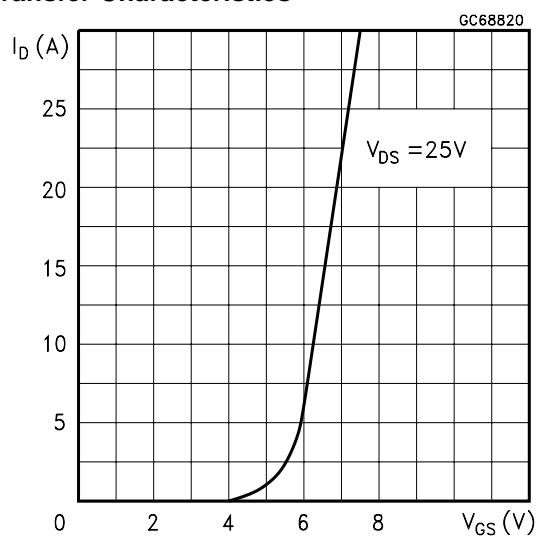

Transconductance

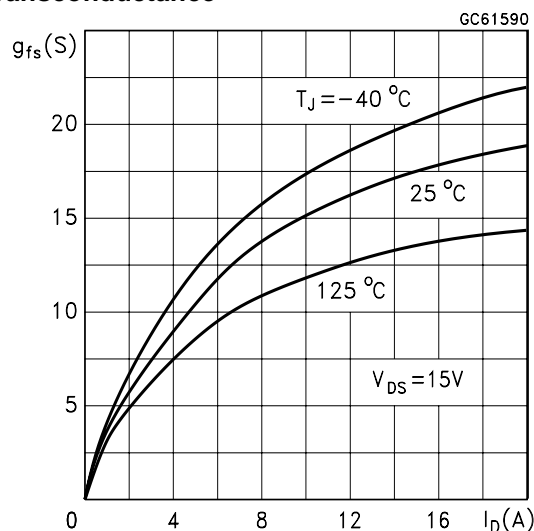

Static Drain-source On Resistance

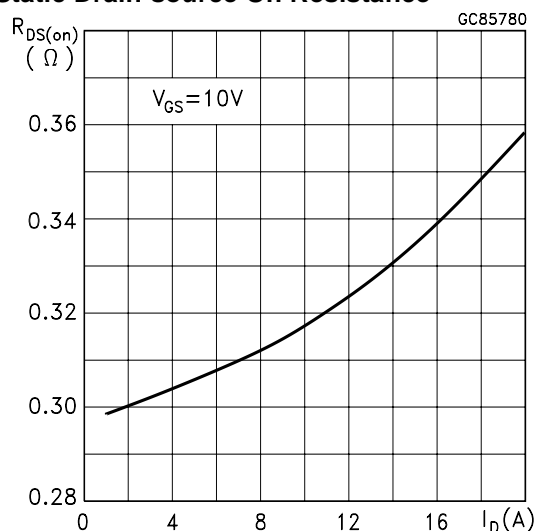

Gate Charge vs Gate-source Voltage

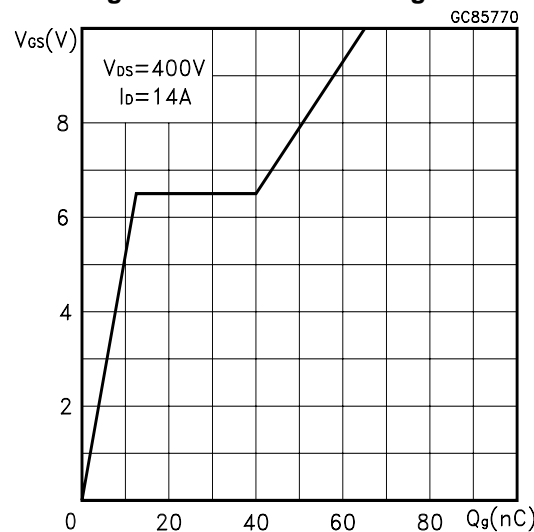

Capacitance Variations

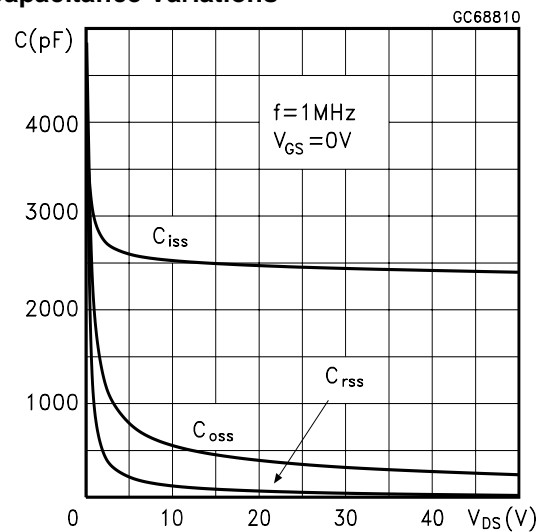

Normalized Gate Threshold Voltage vs Temp.

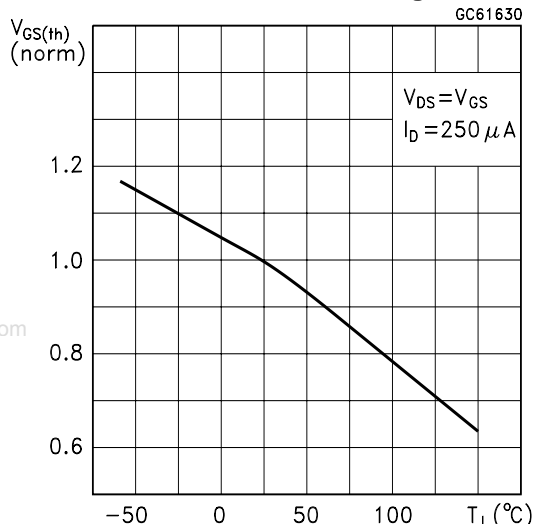

Normalized On Resistance vs Temperature

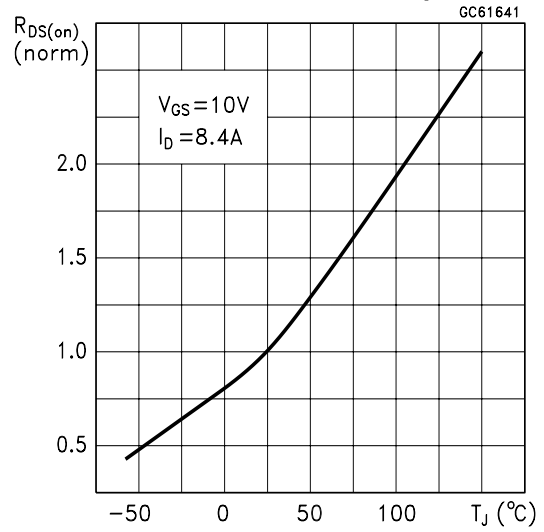

Source-drain Diode Forward Characteristics

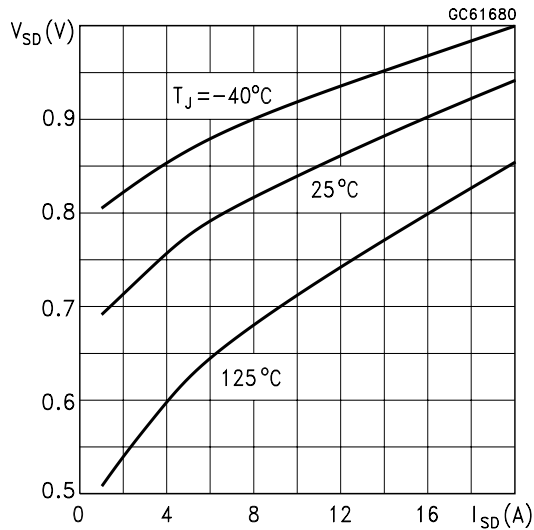

Fig. 1: Unclamped Inductive Load Test Circuit

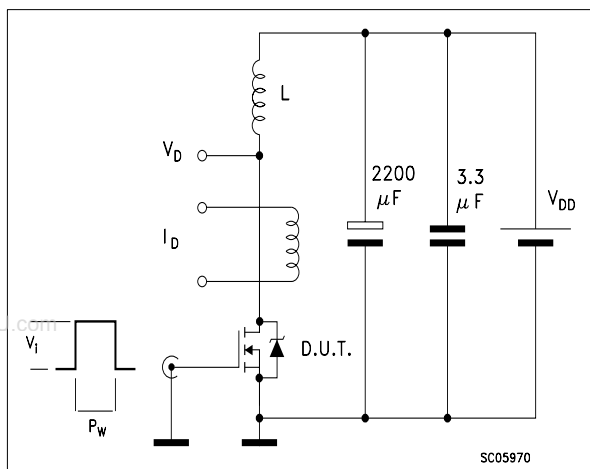

Fig. 2: Unclamped Inductive Waveform



Fig. 3: Switching Times Test Circuit For Resistive Load



Fig. 4: Gate Charge test Circuit



Fig. 5: Test Circuit For Inductive Load Switching And Diode Recovery Times



Max220 MECHANICAL DATA

DIM.	mm			inch		
	MIN.	TYP.	MAX.	MIN.	TYP.	MAX.
A	4.3		4.6	0.169		0.181
A1	2.2		2.4	0.087		0.094
A2	2.9		3.1	0.114		0.122
b	0.7		0.93	0.027		0.036
b1	1.25		1.4	0.049		0.055
b2	1.2		1.38	0.047		0.054
c	0.45		0.6		0.18	0.023
D	15.9		16.3		0.626	0.641
D1	9		9.35	0.354		0.368
D2	0.8		1.2	0.031		0.047
D3	2.8		3.2	0.110		0.126
e	2.44		2.64	0.096		0.104
E	10.05		10.35	0.396		0.407
L	13.2		13.6	0.520		0.535
L1	3		3.4	0.118		0.133

www.DataSheet4U.com

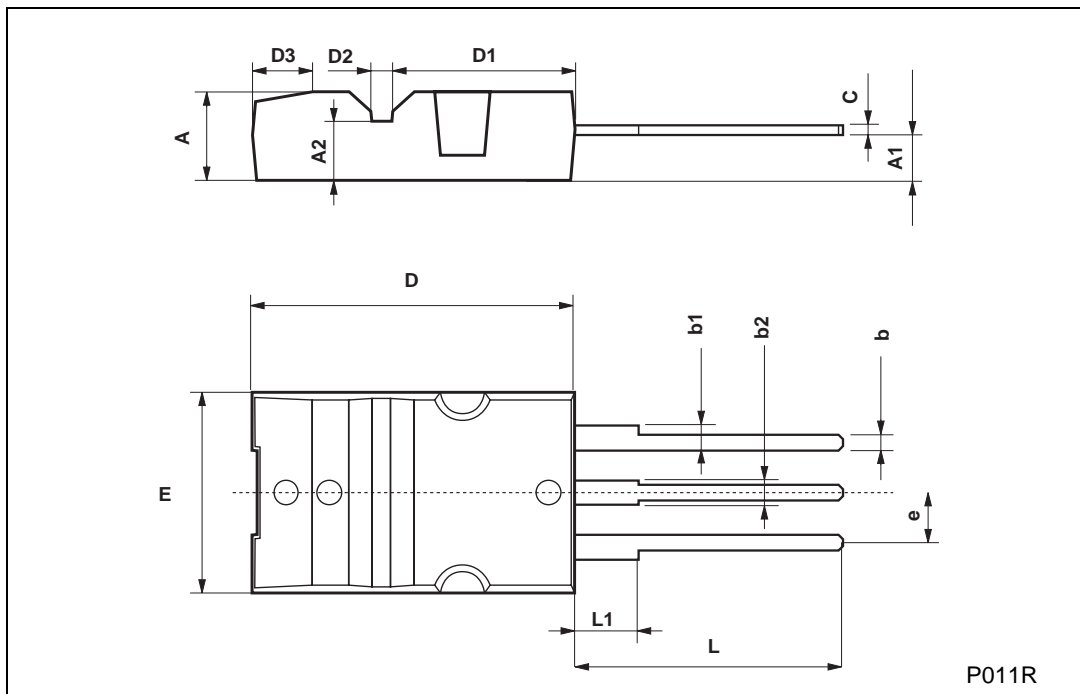

P011R

Information furnished is believed to be accurate and reliable. However, STMicroelectronics assumes no responsibility for the consequences of use of such information nor for any infringement of patents or other rights of third parties which may result from its use. No license is granted by implication or otherwise under any patent or patent rights of STMicroelectronics. Specifications mentioned in this publication are subject to change without notice. This publication supersedes and replaces all information previously supplied. STMicroelectronics products are not authorized for use as critical components in life support devices or systems without express written approval of STMicroelectronics.

The ST logo is registered trademark of STMicroelectronics
© 2000 STMicroelectronics - All Rights Reserved

All other names are the property of their respective owners.

STMicroelectronics GROUP OF COMPANIES
Australia - Brazil - China - Finland - France - Germany - Hong Kong - India - Italy - Japan - Malaysia - Malta - Morocco -
Singapore - Spain - Sweden - Switzerland - United Kingdom - U.S.A.

<http://www.st.com>