



STU312D

SamHop Microelectronics Corp.

Oct 08 2008

Dual Enhancement Mode Field Effect Transistor (N and P Channel)

PRODUCT SUMMARY (N-Channel)		
V _{DSS}	I _D	R _{DS(ON)} (mΩ) Max
30V	18A	24 @ V _{GS} = 10V
		36 @ V _{GS} = 4.5V

PRODUCT SUMMARY (P-Channel)		
V _{DSS}	I _D	R _{DS(ON)} (mΩ) Max
-30V	-14A	34 @ V _{GS} = -10V
		54 @ V _{GS} = -4.5V

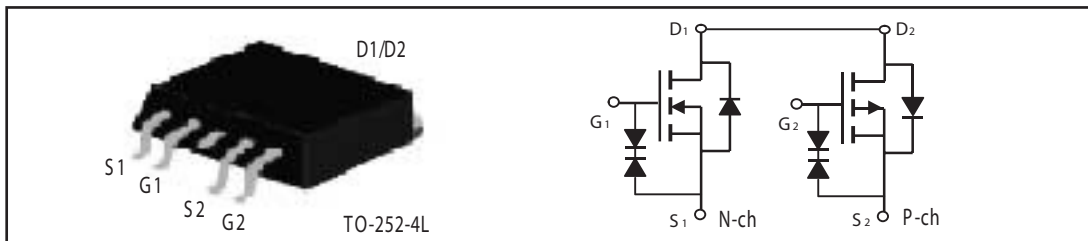

ABSOLUTE MAXIMUM RATINGS (T_A=25°C unless otherwise noted)

Parameter	Symbol	N-Channel	P-Channel	Unit
Drain-Source Voltage	V _{DS}	30	-30	V
Gate-Source Voltage	V _{GS}	±24	±24	V
Drain Current-Continuous @ T _c	I _D	18	-14	A
		15	-12	A
-Pulsed ^a	I _{DM}	50	-50	A
Drain-Source Diode Forward Current	I _S	10	-6	A
Maximum Power Dissipation	P _D	11		W
		7.7		
Operating Junction and Storage Temperature Range	T _J , T _{STG}	-55 to 175		°C

THERMAL CHARACTERISTICS

Thermal Resistance, Junction-to-Case	R _{θJC}	13.6	°C/W
Thermal Resistance, Junction-to-Ambient	R _{θJA}	120	°C/W

STU312D

N-Channel ELECTRICAL CHARACTERISTICS ($T_A = 25^\circ\text{C}$ unless otherwise noted)

Parameter	Symbol	Condition	Min	Typ ^c	Max	Unit
OFF CHARACTERISTICS						
Drain-Source Breakdown Voltage	BV_{DSS}	$V_{GS}=0V, I_D=250\mu A$	30			V
Zero Gate Voltage Drain Current	I_{DSS}	$V_{DS}=24V, V_{GS}=0V$			1	μA
Gate-Body Leakage	I_{GSS}	$V_{GS}=\pm 24V, V_{DS}=0V$			± 100	μA
ON CHARACTERISTICS^a						
Gate Threshold Voltage	$V_{GS(th)}$	$V_{DS}=V_{GS}, I_D=250\mu A$	1	1.8	3	V
Drain-Source On-State Resistance	$R_{DS(ON)}$	$V_{GS}=10V, I_D=10A$		18	24	m ohm
		$V_{GS}=4.5V, I_D=8A$		24	36	m ohm
On-State Drain Current	$I_{D(ON)}$	$V_{DS}=5V, V_{GS}=4.5V$	20			A
Forward Transconductance	g_{FS}	$V_{DS}=10V, I_D=10A$		15		S
DYNAMIC CHARACTERISTICS^b						
Input Capacitance	C_{ISS}	$V_{DS}=15V, V_{GS}=0V$ $f=1.0MHz$		640		pF
Output Capacitance	C_{OSS}			180		pF
Reverse Transfer Capacitance	C_{RSS}			110		pF
Gate resistance	R_g	$V_{GS}=0V, V_{DS}=0V, f=1.0MHz$		0.5		ohm
SWITCHING CHARACTERISTICS^b						
Turn-On Delay Time	$t_{D(ON)}$	$V_{DD}=15V$ $I_D=1A$ $V_{GS}=10V$ $R_{GEN}=6\text{ ohm}$		13		ns
Rise Time	t_r			12		ns
Turn-Off Delay Time	$t_{D(OFF)}$			40		ns
Fall Time	t_f			7		ns
Total Gate Charge	Q_g	$V_{DS}=15V, I_D=20A, V_{GS}=10V$		13		nC
		$V_{DS}=15V, I_D=20A, V_{GS}=4.5V$		6.8		nC
Gate-Source Charge	Q_{gs}	$V_{DS}=15V, I_D=20A$		1.5		nC
Gate-Drain Charge	Q_{gd}	$V_{GS}=10V$		3.5		nC

STU312D

P-Channel ELECTRICAL CHARACTERISTICS (TA = 25 °C unless otherwise noted)

Parameter	Symbol	Condition	Min	Typ ^c	Max	Unit
OFF CHARACTERISTICS						
Drain-Source Breakdown Voltage	BV _{DSS}	V _{GS} = 0V, I _D = -250uA	-30			V
Zero Gate Voltage Drain Current	I _{DSS}	V _{DS} = -24V, V _{GS} = 0V			-1	uA
Gate-Body Leakage	I _{GSS}	V _{GS} = ±24V, V _{DS} = 0V			±100	uA
ON CHARACTERISTICS^a						
Gate Threshold Voltage	V _{GS(th)}	V _{DS} = V _{GS} , I _D = -250uA	-1	-1.7	-3	V
Drain-Source On-State Resistance	R _{DS(ON)}	V _{GS} = -10V, I _D = -6A		27	34	m ohm
		V _{GS} = -4.5V, I _D = -4A		39	54	m ohm
On-State Drain Current	I _{D(ON)}	V _{DS} = -5V, V _{GS} = -10V	-20			A
Forward Transconductance	g _{FS}	V _{DS} = -10V, I _D = -6A		10		S
DYNAMIC CHARACTERISTICS^b						
Input Capacitance	C _{ISS}	V _{DS} = -15V, V _{GS} = 0V f = 1.0MHz		800		pF
Output Capacitance	C _{OSS}			215		pF
Reverse Transfer Capacitance	C _{RSS}			120		pF
Gate resistance	R _g	V _{GS} = 0V, V _{DS} = 0V, f = 1.0MHz		4		ohm
SWITCHING CHARACTERISTICS^b						
Turn-On Delay Time	t _{D(ON)}	V _{DD} = -15V I _D = -1A V _{GS} = -10V R _{GEN} = 6 ohm		12		ns
Rise Time	t _r			18		ns
Turn-Off Delay Time	t _{D(OFF)}			68		ns
Fall Time	t _f			38		ns
Total Gate Charge	Q _g	V _{DS} = -15V, I _D = -20A, V _{GS} = -10V		15		nC
		V _{DS} = -15V, I _D = -20A, V _{GS} = -4.5V		7		nC
Gate-Source Charge	Q _{gs}	V _{DS} = -15V, I _D = -20 A		1.3		nC
Gate-Drain Charge	Q _{gd}	V _{GS} = -10V		5		nC

STU312D

ELECTRICAL CHARACTERISTICS ($T_A=25^\circ\text{C}$ unless otherwise noted)

Parameter	Symbol	Condition	Min	Typ ^c	Max	Unit
DRAIN-SOURCE DIODE CHARACTERISTICS^b						
Diode Forward Voltage	V_{SD}	$V_{GS} = 0V, I_s = 10A$	N-Ch	0.9	1.3	V
		$V_{GS} = 0V, I_s = -6A$	P-Ch	-0.9	-1.3	

Notes

a. Pulse Test: Pulse Width $\leq 300 \mu s$, Duty Cycle $\leq 2\%$.

b. Guaranteed by design, not subject to production testing.

N-Channel

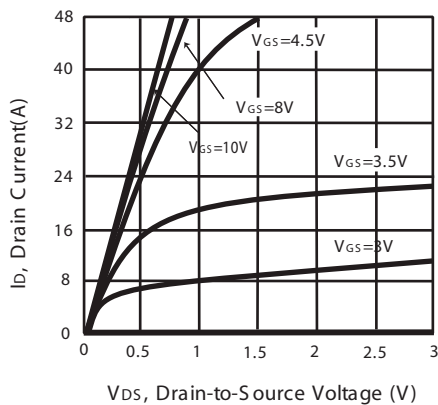

Figure 1. Output Characteristics

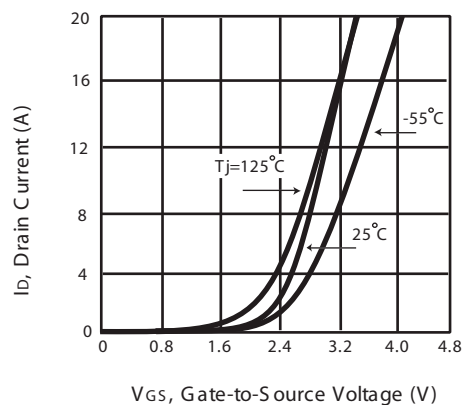

Figure 2. Transfer Characteristics

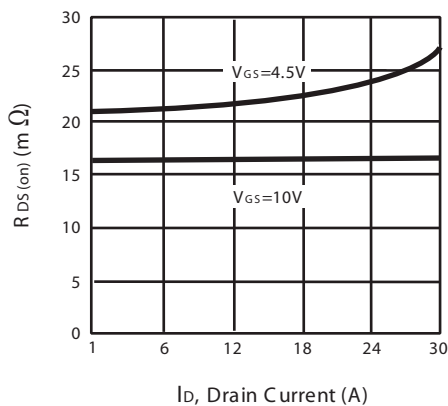

Figure 3. On-Resistance vs. Drain Current and Gate Voltage

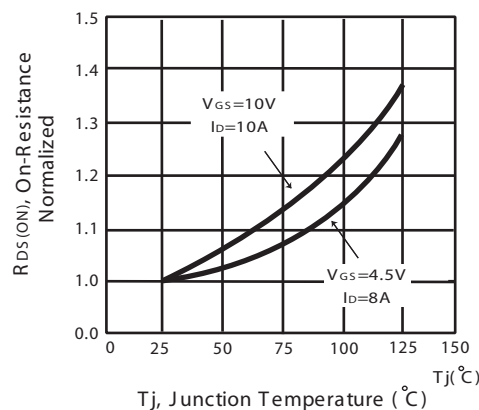

Figure 4. On-Resistance Variation with Drain Current and Temperature

STU312D

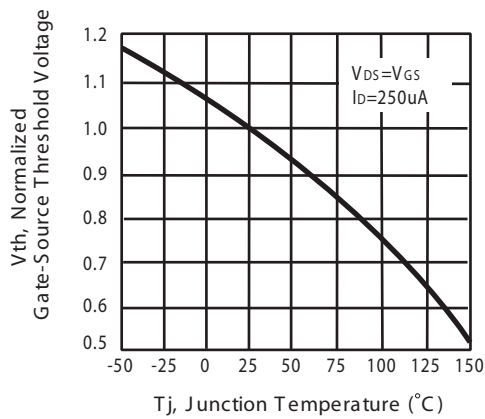

Figure 5. Gate Threshold Variation with Temperature

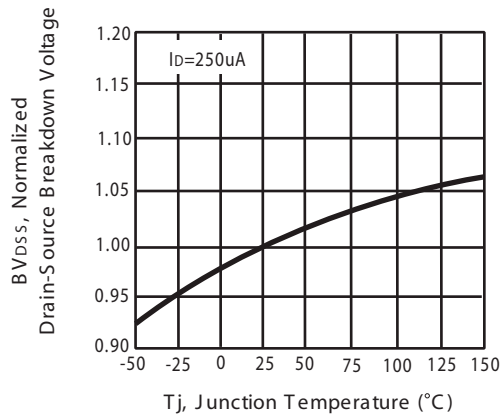

Figure 6. Breakdown Voltage Variation with Temperature

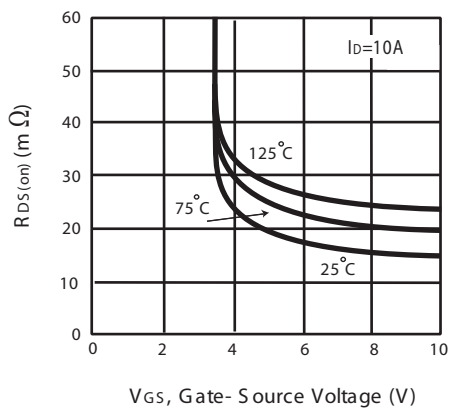

Figure 7. On-Resistance vs. Gate-Source Voltage

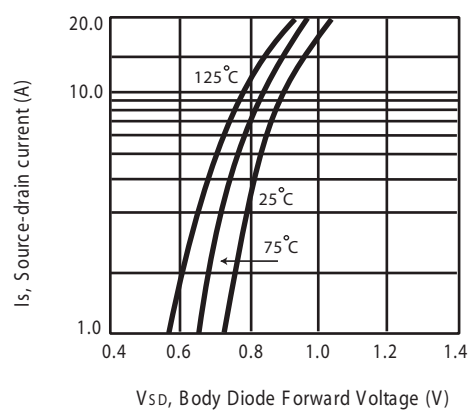
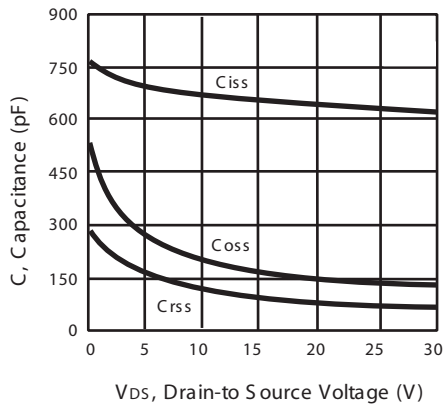

Figure 8. Body Diode Forward Voltage Variation with Source Current

STU312D



V_{DS} , Drain-to Source Voltage (V)

Figure 10. Capacitance

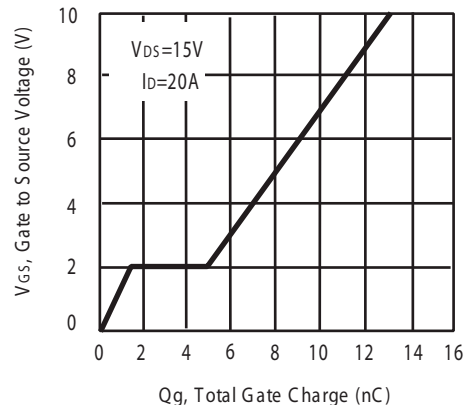

Q_g , Total Gate Charge (nC)

Figure 11. Gate Charge

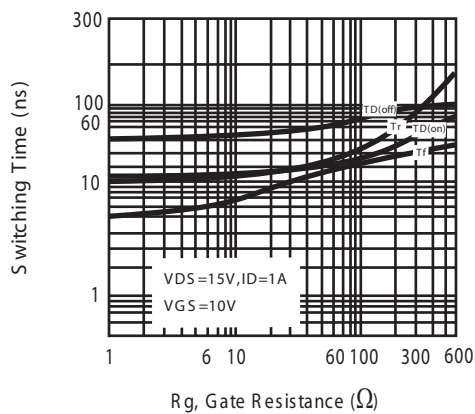

Figure 12. switching characteristics

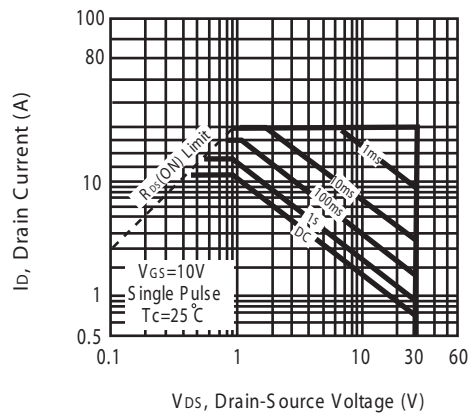

Figure 13. Maximum Safe Operating Area

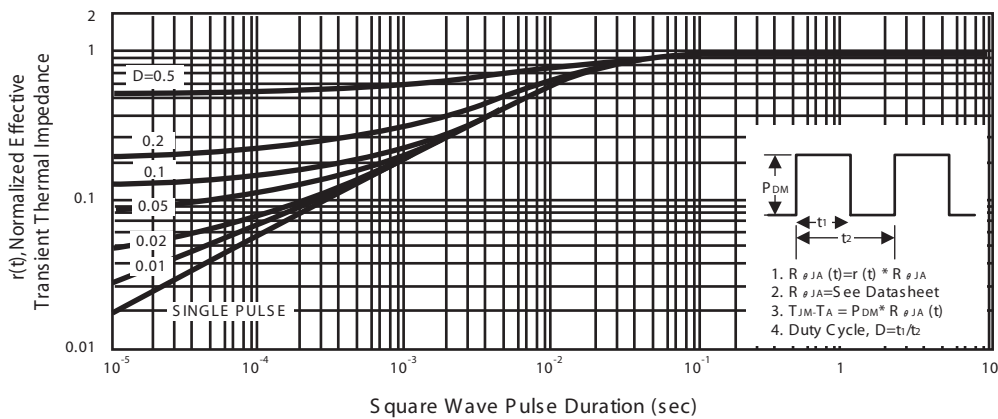

Figure 14. Normalized Thermal Transient Impedance Curve

STU312D

P-Channel

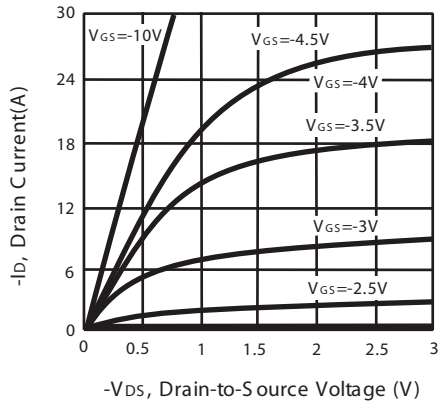

Figure 1. Output Characteristics

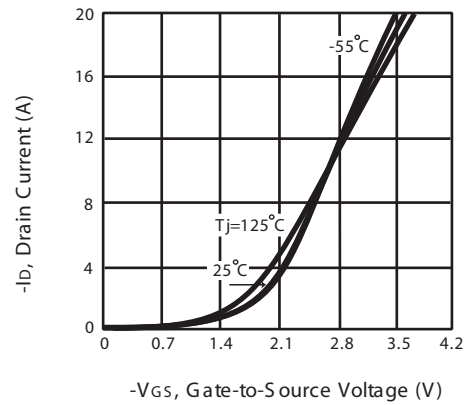

Figure 2. Transfer Characteristics

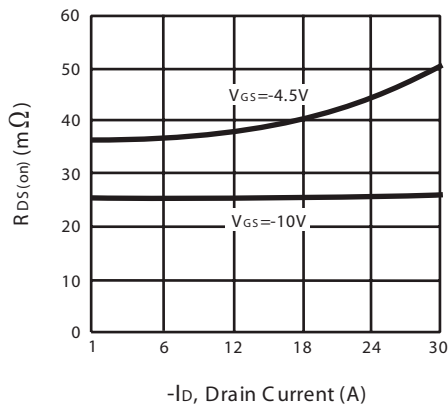

Figure 3. On-Resistance vs. Drain Current and Gate Voltage

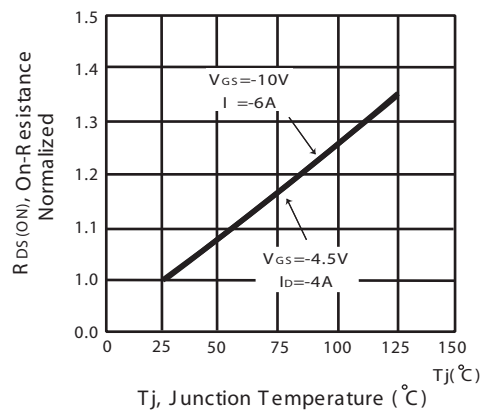

Figure 4. On-Resistance Variation with Drain Current and Temperature

STU312D

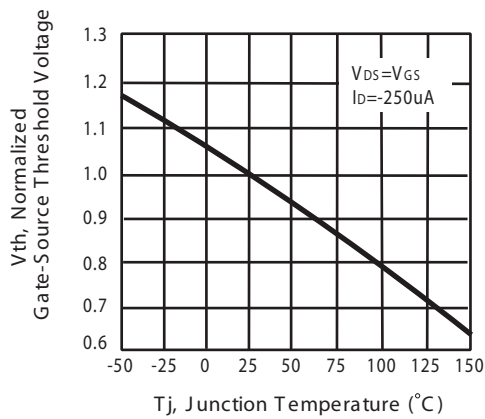

Figure 5. Gate Threshold Variation with Temperature

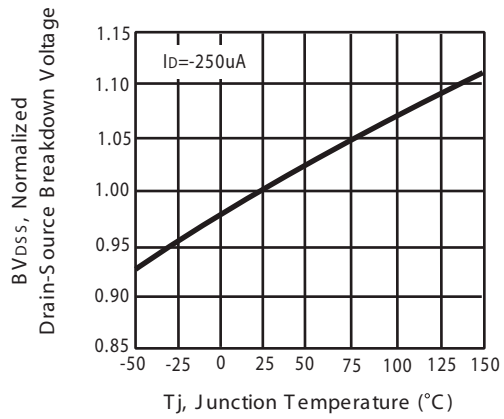

Figure 6. Breakdown Voltage Variation with Temperature

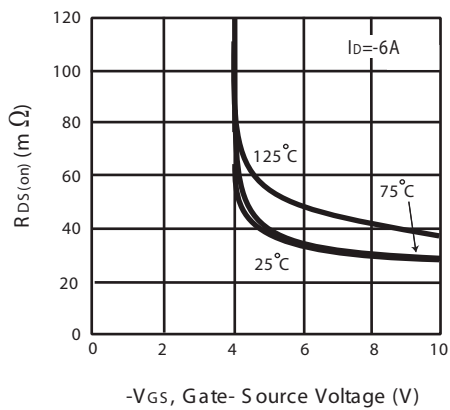

Figure 7. On-Resistance vs. Gate-Source Voltage

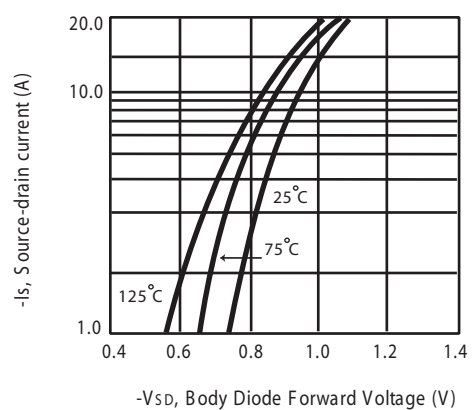

Figure 8. Body Diode Forward Voltage Variation with Source Current

STU312D

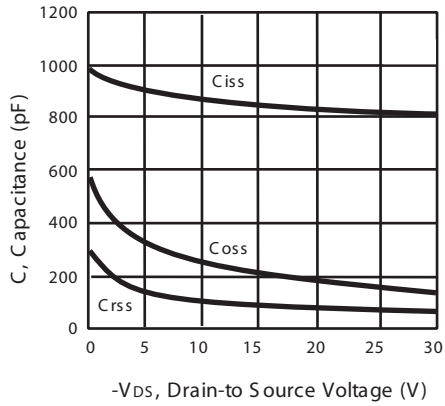

Figure 10. Capacitance

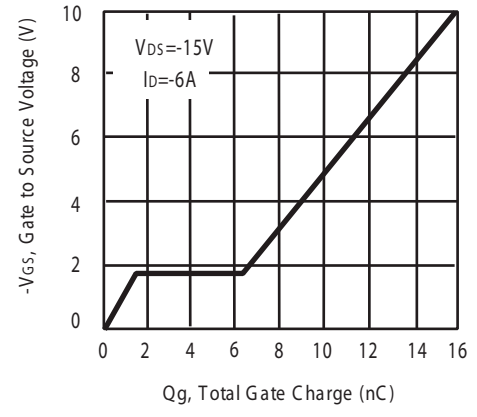

Figure 11. Gate Charge

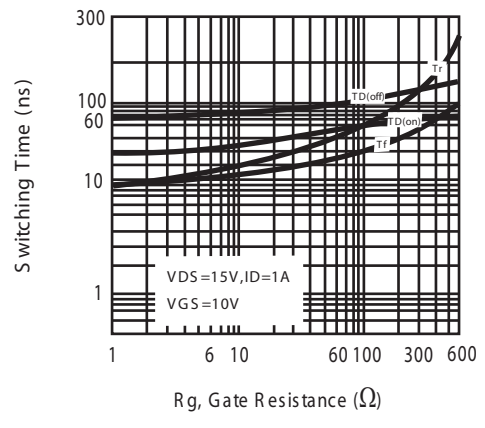

Figure 12. switching characteristics

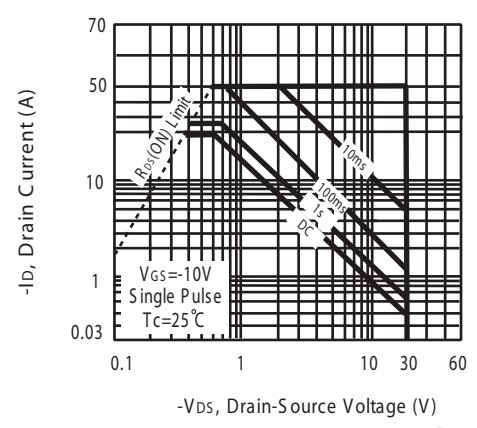

Figure 13. Maximum Safe Operating Area

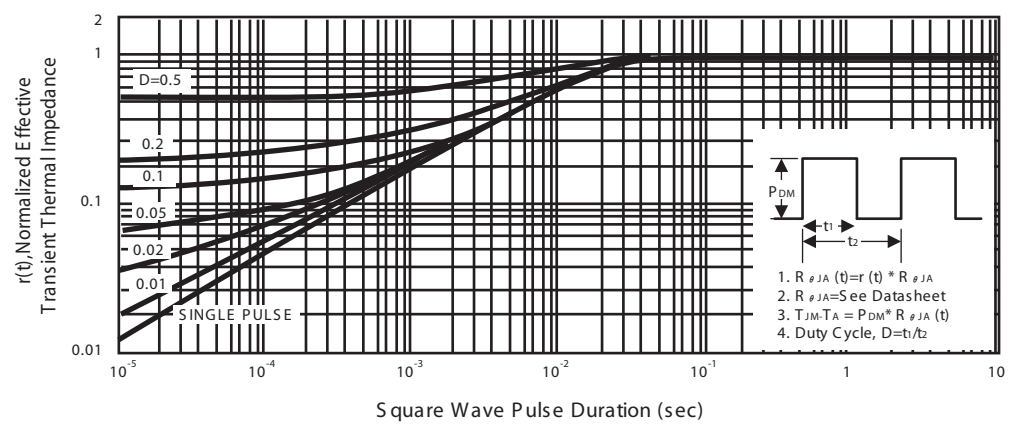
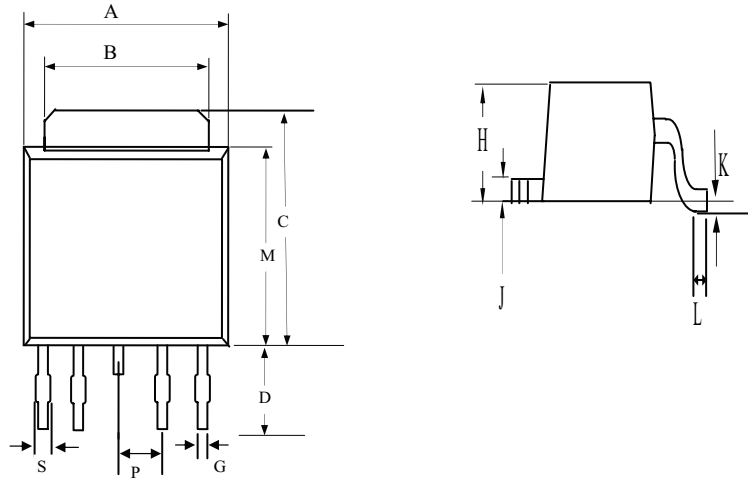

Figure 14. Normalized Thermal Transient Impedance Curve

STU312D

PACKAGE OUTLINE DIMENSIONS

TO-252-4L



REF .	Millimeters	
	MIN	MAX
A	6.40	6.80
B	5.2	5.50
C	6.80	10.20
D	2.20	3.00
P	1.27 REF.	
S	0.50	0.80
G	0.40	0.60
H	2.20	2.40
J	0.45	0.60
K	0	0.15
L	0.90	1.50
M	5.40	5.80

STU312D

TO-252-4L Tape and Reel Data

TO-252-4L Carrier Tape

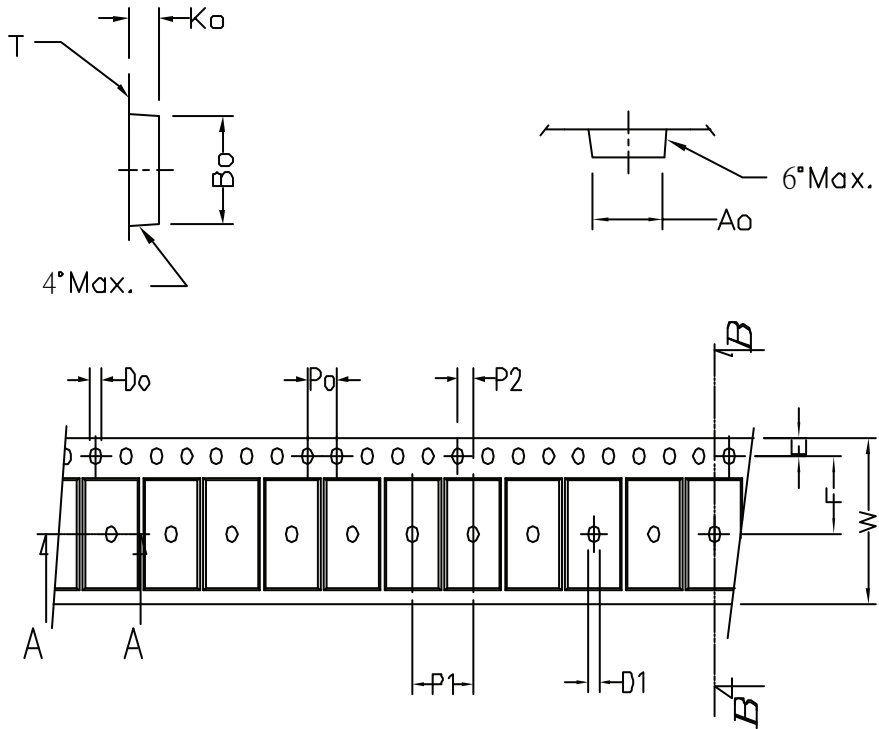

symbol	Ao	Bo	Ko	Po	P1	P2	T
Spec	6.96±0.1	10.49±0.1	2.79±0.1	4.0±0.1	8.0±0.10	2.0±0.05	0.33±0.013
symbol	E	F	Do	D1	W	10Po	
Spec	1.75±0.1	7.5±0.05	1.55±0.05	1.5±0.25	16.0 ^{+0.3} _{-0.1}	40.0±0.2	

TO-252-4L Reel

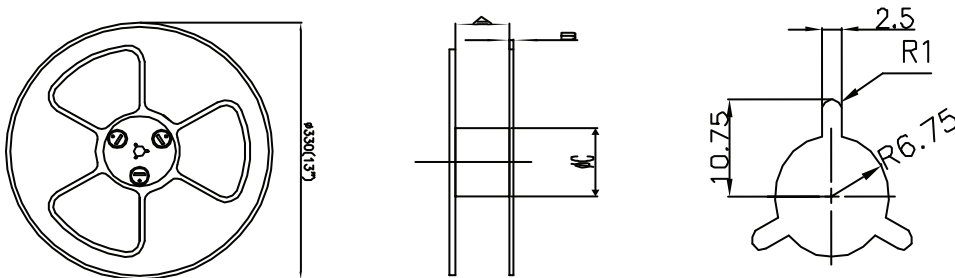

UNIT:mm

Width of carrier tape	8	12	16	24	32	44	56
A±0.1	9.4	13.4	17.4	25.4	33.4	45.4	57.4
B	2.3	2.3	2.3	2.3	2.3	2.3	2.3
øC	100	100	100	100	100	100	100