



Dual N-Channel Enhancement Mode Field Effect Transistor

PRODUCT SUMMARY		
V _{DS}	I _D	R _{DS(ON)} (mΩ) Max
40V	16A	30 @ V _{GS} = 10V
		40 @ V _{GS} = 4.5V

FEATURES

- Super high dense cell design for low R_{DS(ON)}.
- Rugged and reliable.
- TO252-4L package.
- ESD Protected.

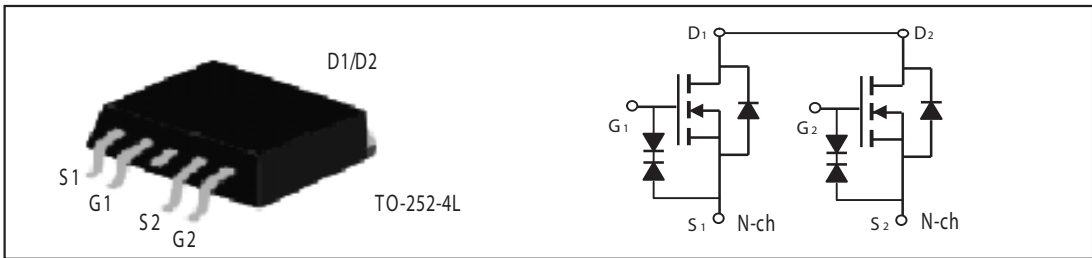

ABSOLUTE MAXIMUM RATINGS (T_A=25°C unless otherwise noted)

Parameter	Symbol	Limit	Unit	
Drain-Source Voltage	V _{DS}	40	V	
Gate-Source Voltage	V _{GS}	±20	V	
Drain Current-Continuous @ T _a	I _D	25°C	16	A
		70°C	13.8	A
-Pulsed ^a	I _{DM}	50	A	
Drain-Source Diode Forward Current	I _S	8	A	
Maximum Power Dissipation	P _D	T _a = 25°C	11	W
		T _a =70°C	7.7	
Operating Junction and Storage Temperature Range	T _J , T _{STG}	-55 to 175	°C	

THERMAL CHARACTERISTICS

Thermal Resistance, Junction-to-Case	R _{θJC}	13.6	°C/W
Thermal Resistance, Junction-to-Ambient	R _{θJA}	120	°C/W

STU408D

ELECTRICAL CHARACTERISTICS (T_A =25°C unless otherwise noted)

Parameter	Symbol	Condition	Min	Typ ^c	Max	Unit
OFF CHARACTERISTICS						
Drain-Source Breakdown Voltage	BV _{DSS}	V _{GS} = 0V, I _D = 250uA	40			V
Zero Gate Voltage Drain Current	I _{DSS}	V _{DS} = 32V, V _{GS} = 0V			1	uA
Gate-Body Leakage	I _{GSS}	V _{GS} = ± 20V, V _{DS} = 0V			±10	uA
ON CHARACTERISTICS^b						
Gate Threshold Voltage	V _{GS(th)}	V _{DS} = V _{GS} , I _D = 250uA	1	1.8	3.0	V
Drain-Source On-State Resistance	R _{DS(ON)}	V _{GS} = 10V, I _D = 8A		22	30	m-ohm
		V _{GS} = 4.5V, I _D = 6A		30	40	m-ohm
On-State Drain Current	I _{D(ON)}	V _{DS} = 5V, V _{GS} = 4.5V	10			A
Forward Transconductance	g _{FS}	V _{DS} = 5V, I _D = 8A		15		S
DYNAMIC CHARACTERISTICS^c						
Input Capacitance	C _{ISS}	V _{DS} = 20V, V _{GS} = 0V f = 1.0MHz		735		pF
Output Capacitance	C _{OSS}			120		pF
Reverse Transfer Capacitance	C _{RSS}			70		pF
SWITCHING CHARACTERISTICS^c						
Turn-On Delay Time	t _{D(ON)}	V _{DD} = 20V, I _D = 3A, V _{GS} = 10V, R _{GEN} = 3 ohm		13		ns
Rise Time	t _r			15		ns
Turn-Off Delay Time	t _{D(OFF)}			26		ns
Fall Time	t _f			10		ns
Total Gate Charge (10V)	Q _g	V _{DS} = 20V, I _D = 8A, V _{GS} = 10V		15		nC
Total Gate Charge (4.5V)	Q _g			7.2		nC
Gate-Source Charge	Q _{gs}			2.0		nC
Gate-Drain Charge	Q _{gd}			3.8		nC

STU408D

ELECTRICAL CHARACTERISTICS (T_c=25°C unless otherwise noted)

Parameter	Symbol	Condition	Min	Typ	Max	Unit
DRAIN-SOURCE DIODE CHARACTERISTICS^a						
Diode Forward Voltage	V _{SD}	V _{GS} = 0V, I _s = 8A		0.94	1.3	V

Notes

- a. Pulse Test: Pulse Width ≤ 300us, Duty Cycle ≤ 2%.
- b. Guaranteed by design, not subject to production testing.

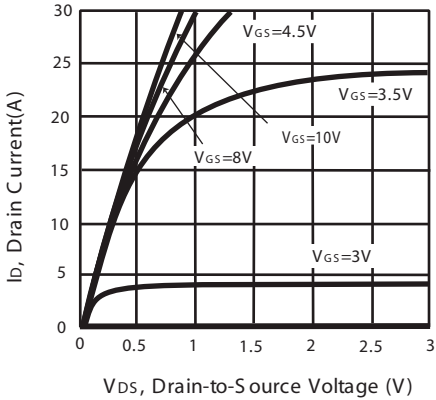

Figure 1. Output Characteristics

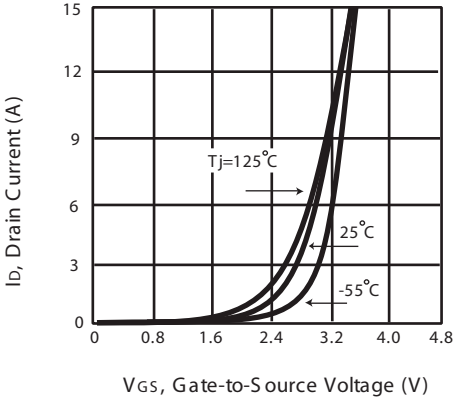

Figure 2. Transfer Characteristics

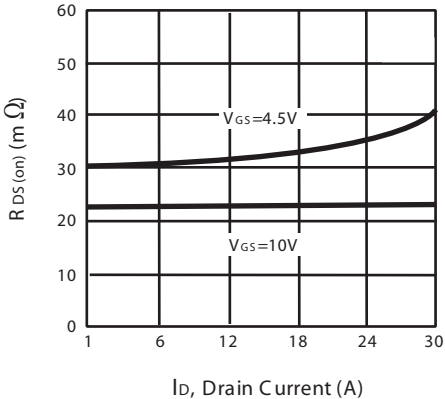

Figure 3. On-Resistance vs. Drain Current and Gate Voltage

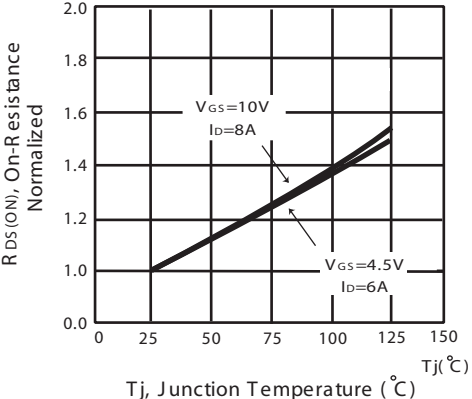

Figure 4. On-Resistance Variation with Drain Current and Temperature

STU408D

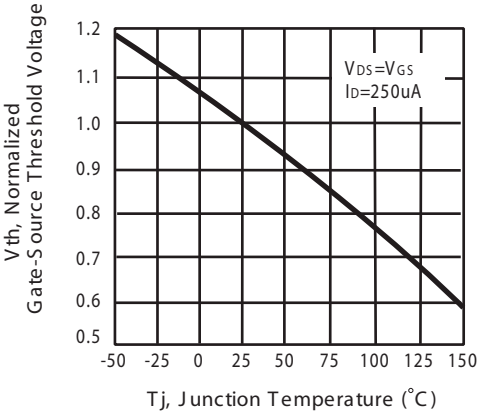

Figure 5. Gate Threshold Variation with Temperature

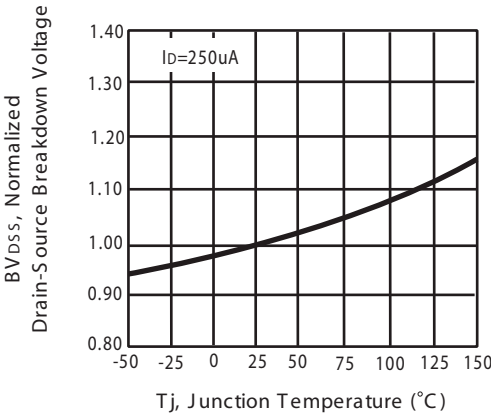

Figure 6. Breakdown Voltage Variation with Temperature

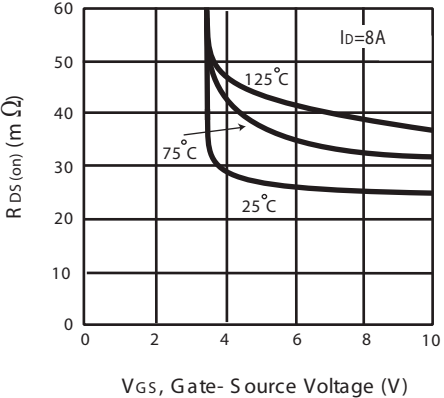

Figure 7. On-Resistance vs. Gate-Source Voltage

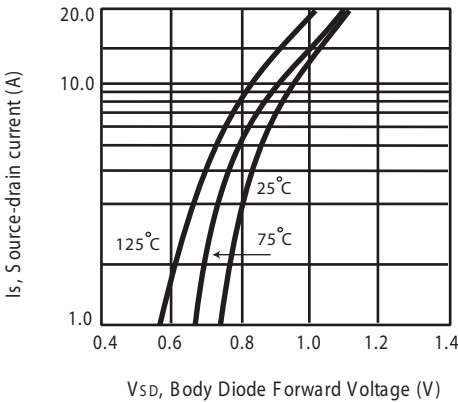
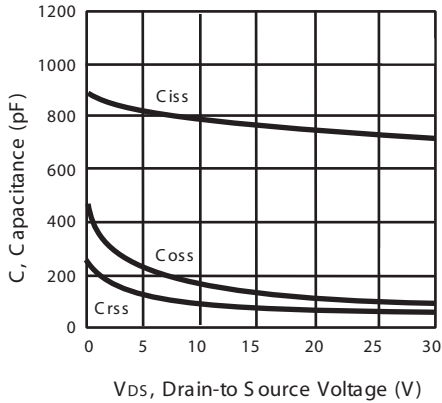

Figure 8. Body Diode Forward Voltage Variation with Source Current

STU408D



V_{DS}, Drain-to Source Voltage (V)

Figure 9. Capacitance

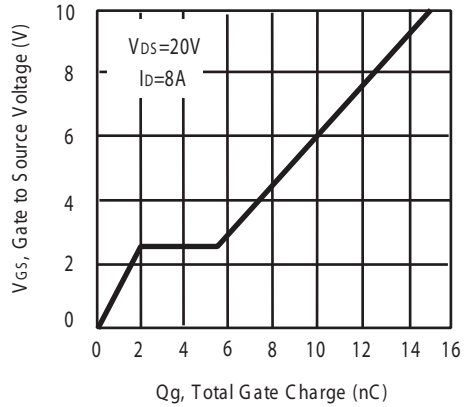

Q_g, Total Gate Charge (nC)

Figure 10. Gate Charge

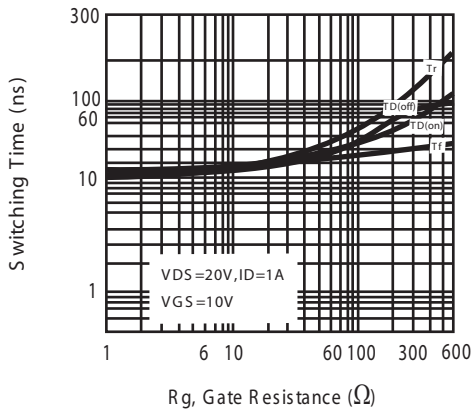

Figure 11. switching characteristics

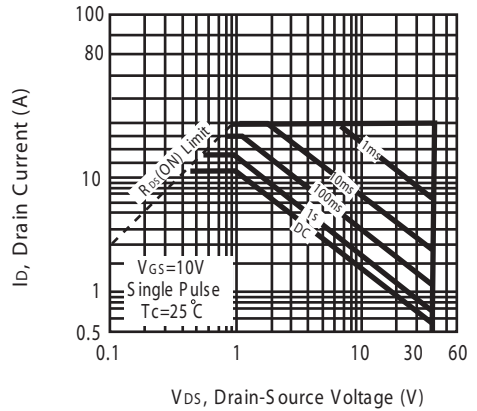
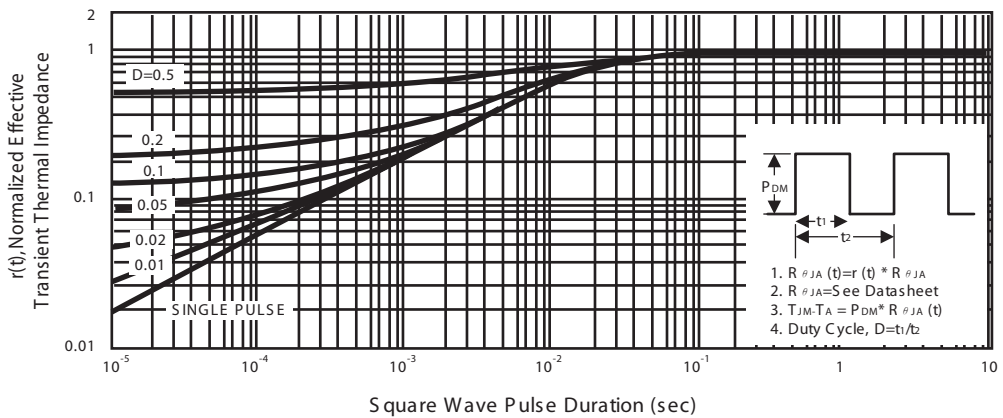

Figure 12. Maximum Safe Operating Area



1. $R_{\theta JA}(t) = r(t) * R_{\theta JA}$
2. $R_{\theta JA}$ = See Datasheet
3. $T_{JM-TA} = P_{DM} * R_{\theta JA}(t)$
4. Duty Cycle, $D = t_1/t_2$

www.DataSheet4U.com Figure 13. Normalized Thermal Transient Impedance Curve

STU408D

PACKAGE OUTLINE DIMENSIONS

TO-252-4L

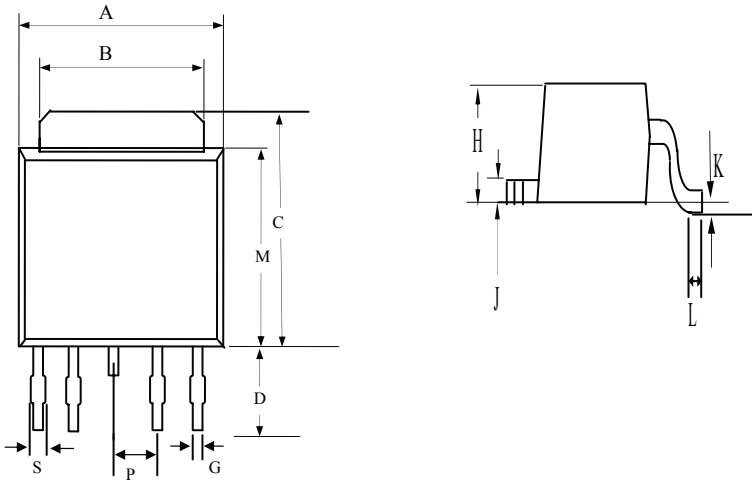

REF .	Millimeters	
	MIN	MAX
A	6.40	6.80
B	5.2	5.50
C	6.80	10.20
D	2.20	3.00
P	1.27 REF.	
S	0.50	0.80
G	0.40	0.60
H	2.20	2.40
J	0.45	0.60
K	0	0.15
L	0.90	1.50
M	5.40	5.80

STU408D

TO-252-4L Tape and Reel Data

TO-252-4L Carrier Tape

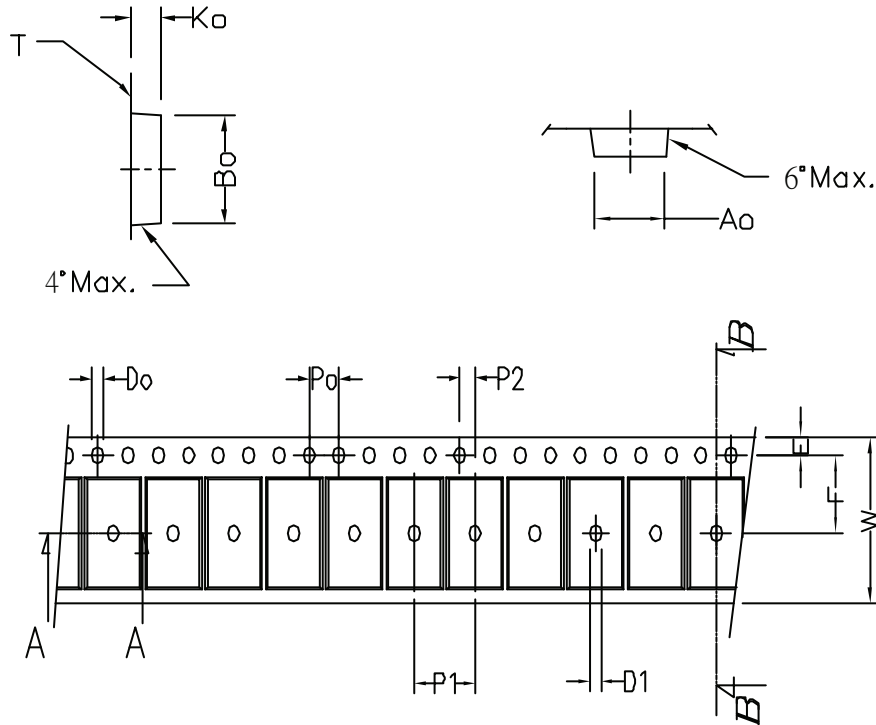

symbol	A_0	B_0	K_0	P_0	P_1	P_2	T
Spec	6.96 ± 0.1	10.49 ± 0.1	2.79 ± 0.1	4.0 ± 0.1	8.0 ± 0.10	2.0 ± 0.05	0.33 ± 0.013
symbol	E	F	D_0	D_1	W	$10P_0$	
Spec	1.75 ± 0.1	7.5 ± 0.05	1.55 ± 0.05	1.5 ± 0.25	16.0 ± 0.3	40.0 ± 0.2	

TO-252-4L Reel

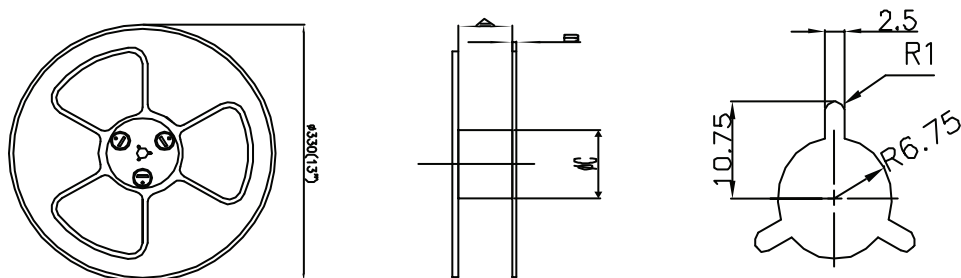

UNIT:mm

Width of carrier tape	8	12	16	24	32	44	56
$A \pm 0.1$	9.4	13.4	17.4	25.4	33.4	45.4	57.4
B	2.3	2.3	2.3	2.3	2.3	2.3	2.3
ϕC	100	100	100	100	100	100	100