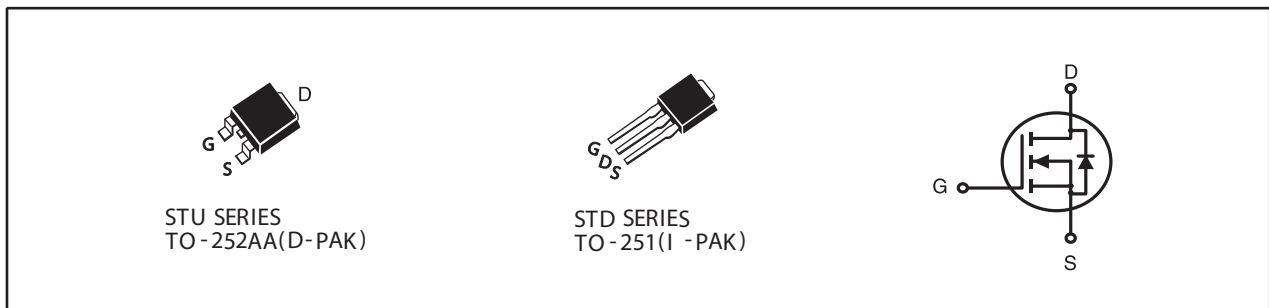

**N-Channel Logic Enhancement Mode Field Effect Transistor****PRODUCT SUMMARY**

V _{DSS}	I _D	R _{DS(ON)} (mΩ) Max
40V	42A	10 @ V _{GS} =10V
		15 @ V _{GS} =4.5V

FEATURES

- Super high dense cell design for low R_{DS(ON)}.
- Rugged and reliable.
- TO-252 and TO251 Package.

**ABSOLUTE MAXIMUM RATINGS (T_C=25°C unless otherwise noted)**

Symbol	Parameter	Limit	Units
V _{DS}	Drain-Source Voltage	40	V
V _{GS}	Gate-Source Voltage	±20	V
I _D	Drain Current-Continuous ^a	T _C =25°C	42
		T _C =70°C	34
I _{DM}	-Pulsed ^b	123	A
E _{AS}	Single Pulse Avalanche Energy ^d	121	mJ
P _D	Maximum Power Dissipation ^a	T _C =25°C	42
		T _C =70°C	27
T _J , T _{STG}	Operating Junction and Storage Temperature Range	-55 to 150	°C

THERMAL CHARACTERISTICS

R _{θJC}	Thermal Resistance, Junction-to-Case ^a	3	°C/W
R _{θJA}	Thermal Resistance, Junction-to-Ambient ^a	50	°C/W

STU/D432L

Ver 1.0

ELECTRICAL CHARACTERISTICS (T_C=25°C unless otherwise noted)

Symbol	Parameter	Conditions	Min	Typ	Max	Units
OFF CHARACTERISTICS						
B _V DSS	Drain-Source Breakdown Voltage	V _{GS} =0V , I _D =250uA	40			V
I _D SS	Zero Gate Voltage Drain Current	V _{DS} =32V , V _{GS} =0V			1	uA
I _G SS	Gate-Body Leakage Current	V _{GS} = ±20V , V _{DS} =0V			±100	nA
ON CHARACTERISTICS						
V _{GS} (th)	Gate Threshold Voltage	V _{DS} =V _{GS} , I _D =250uA	1	1.5	3	V
R _{DS} (ON)	Drain-Source On-State Resistance	V _{GS} =10V , I _D =21A		8	10	m ohm
		V _{GS} =4.5V , I _D =17A		11	15	m ohm
g _{FS}	Forward Transconductance	V _{DS} =10V , I _D =21A		39		S
DYNAMIC CHARACTERISTICS ^c						
C _{ISS}	Input Capacitance	V _{DS} =20V, V _{GS} =0V f=1.0MHz		1290		pF
C _{OSS}	Output Capacitance			175		pF
C _{RSS}	Reverse Transfer Capacitance			152		pF
SWITCHING CHARACTERISTICS ^c						
t _D (ON)	Turn-On Delay Time	V _{DD} =20V I _D =1A		19		ns
t _r	Rise Time			28		ns
t _D (OFF)	Turn-Off Delay Time	V _{GS} =10V R _{GEN} =6 ohm		70		ns
t _f	Fall Time			30		ns
Q _g	Total Gate Charge	V _{DS} =20V, I _D =21A, V _{GS} =10V		25		nC
		V _{DS} =20V, I _D =21A, V _{GS} =4.5V		12.2		nC
Q _{gs}	Gate-Source Charge	V _{DS} =20V, I _D =21A, V _{GS} =10V		2.1		nC
Q _{gd}	Gate-Drain Charge			8		nC
DRAIN-SOURCE DIODE CHARACTERISTICS						
V _{SD}	Diode Forward Voltage	V _{GS} =0V, I _S =2A		0.76	1.3	V

Notes

- Surface Mounted on FR4 Board, t < 10sec.
- Pulse Test: Pulse Width ≤ 300us, Duty Cycle ≤ 2%.
- Guaranteed by design, not subject to production testing.
- Starting T_J=25°C, L=0.5mH, V_{DD} = 20V. (See Figure13)

Oct,12,2011

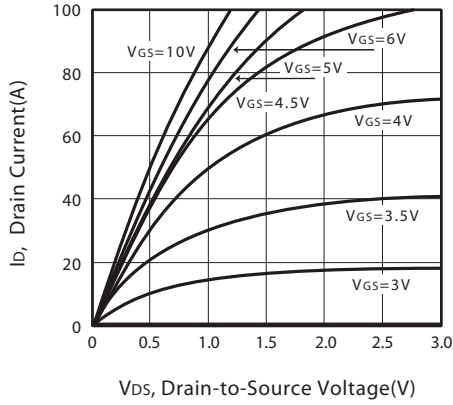

Figure 1. Output Characteristics

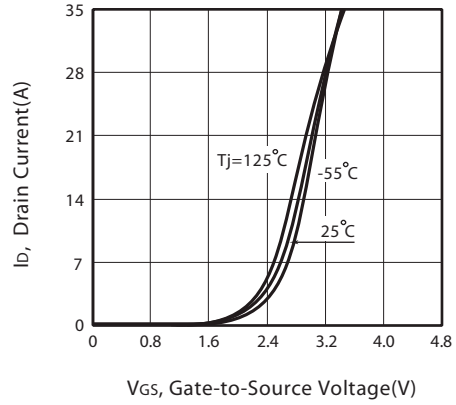

Figure 2. Transfer Characteristics

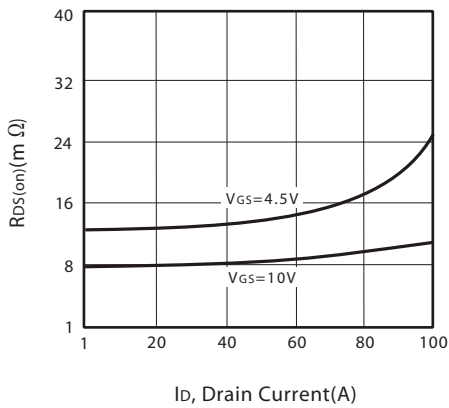

Figure 3. On-Resistance vs. Drain Current and Gate Voltage

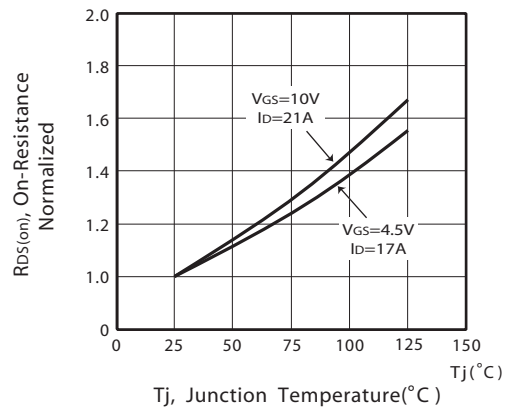

Figure 4. On-Resistance Variation with Drain Current and Temperature

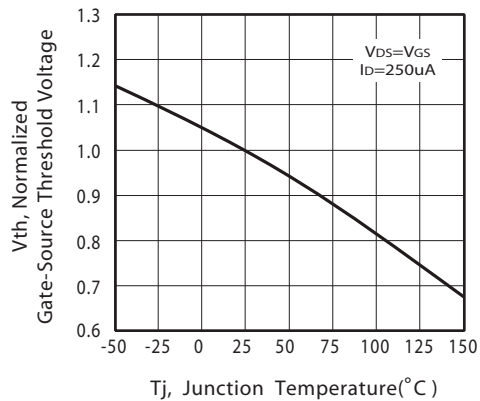

Figure 5. Gate Threshold Variation with Temperature

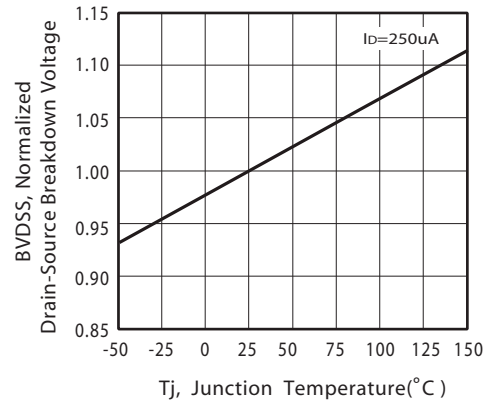

Figure 6. Breakdown Voltage Variation with Temperature

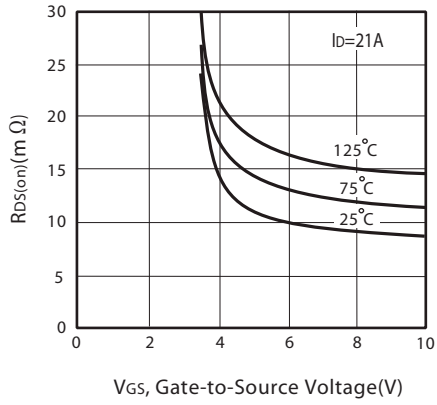

Figure 7. On-Resistance vs. Gate-Source Voltage

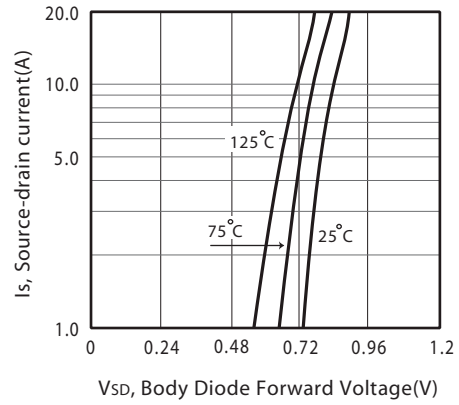

Figure 8. Body Diode Forward Voltage Variation with Source Current

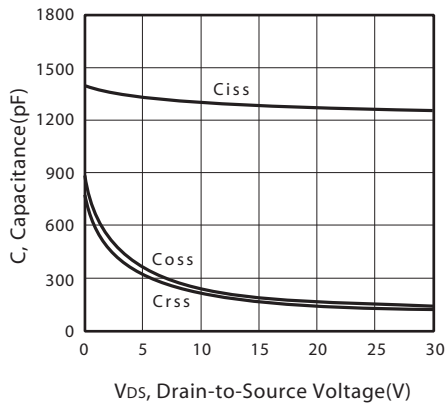

Figure 9. Capacitance

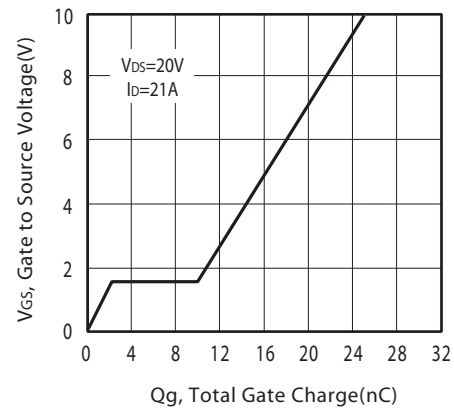

Figure 10. Gate Charge

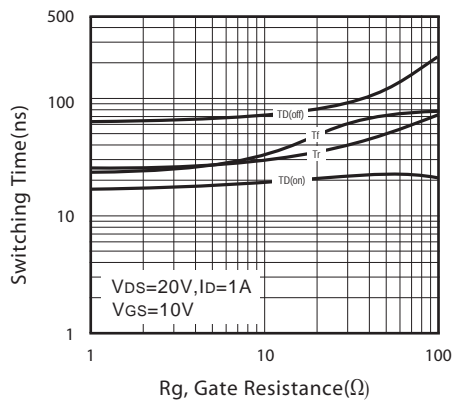

Figure 11. switching characteristics

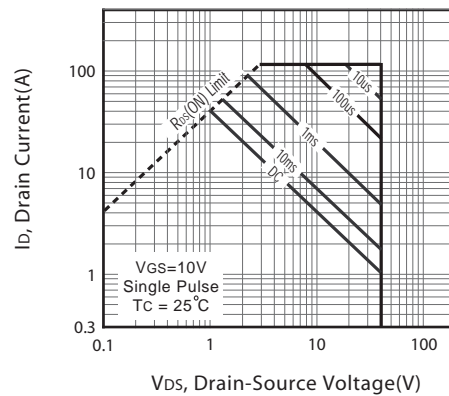
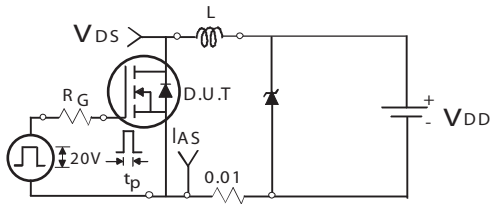
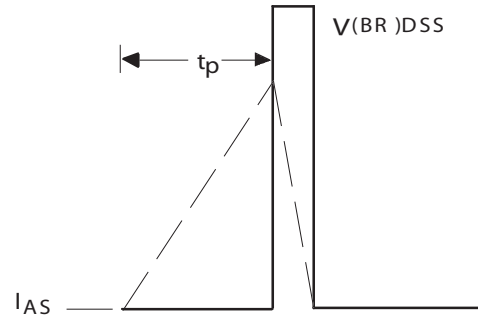

Figure 12. Maximum Safe Operating Area



Unclamped Inductive Test Circuit

Figure 13a.



Unclamped Inductive Waveforms

Figure 13b.

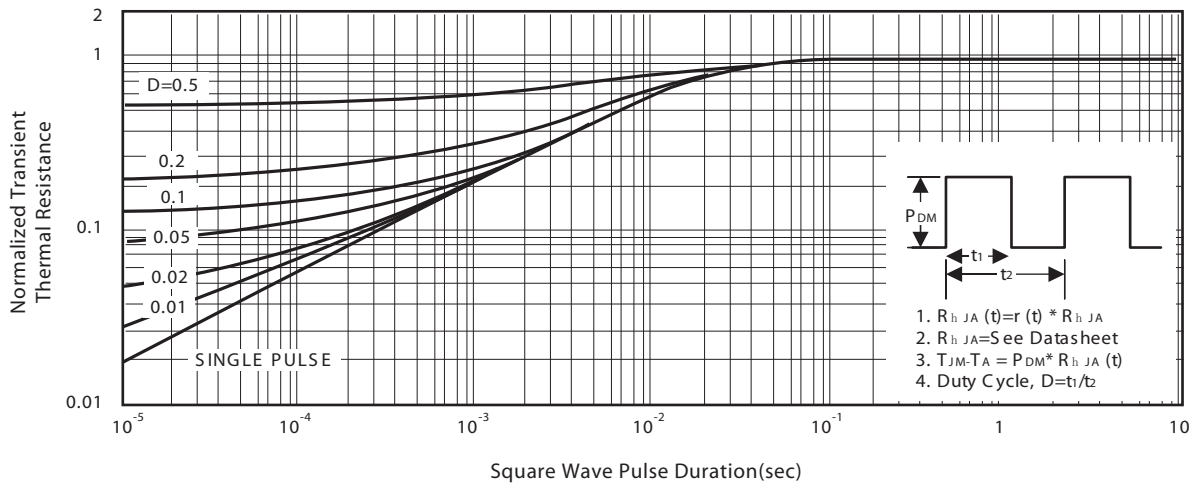
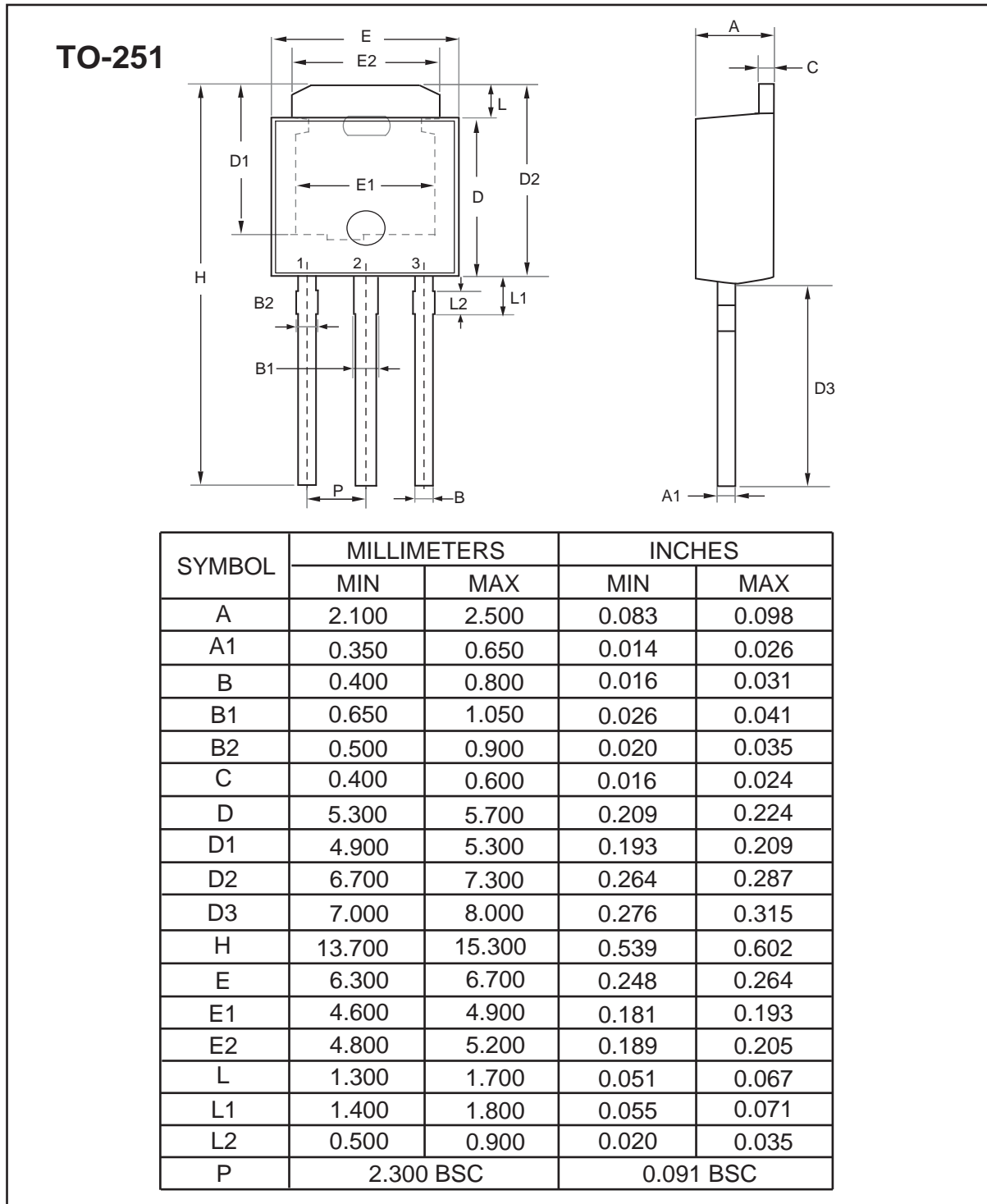
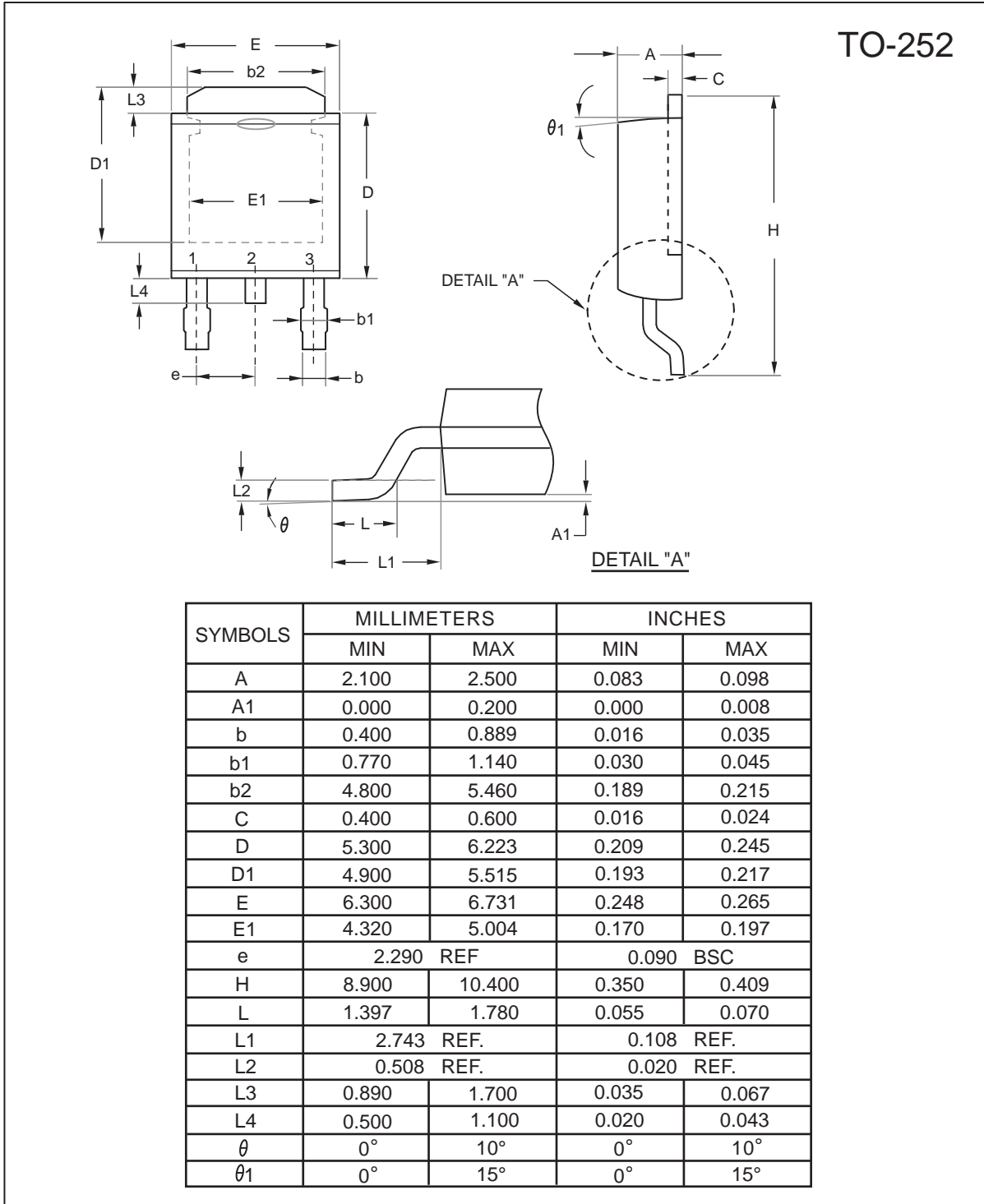

Figure 14. Normalized Thermal Transient Impedance Curve

PACKAGE OUTLINE DIMENSIONS





TO-251 Tube/TO-252 Tape and Reel Data

TO-251 Tube

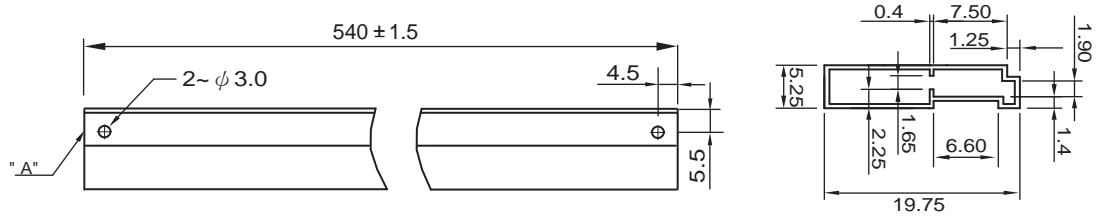

TO-252 Carrier Tape

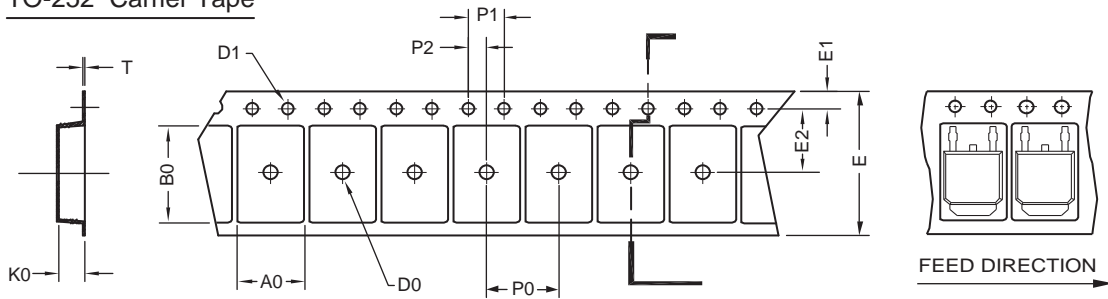

UNIT:mm

PACKAGE	A0	B0	K0	D0	D1	E	E1	E2	P0	P1	P2	T
TO-252 (16 mm)	6.96 ±0.1	10.49 ±0.1	2.79 ±0.1	φ 2	φ 1.5 +0.1 - 0	16.0 ±0.3	1.75 ±0.1	7.5 ±0.15	8.0 ±0.1	4.0 ±0.1	2.0 ±0.15	0.3 ±0.05

TO-252 Reel

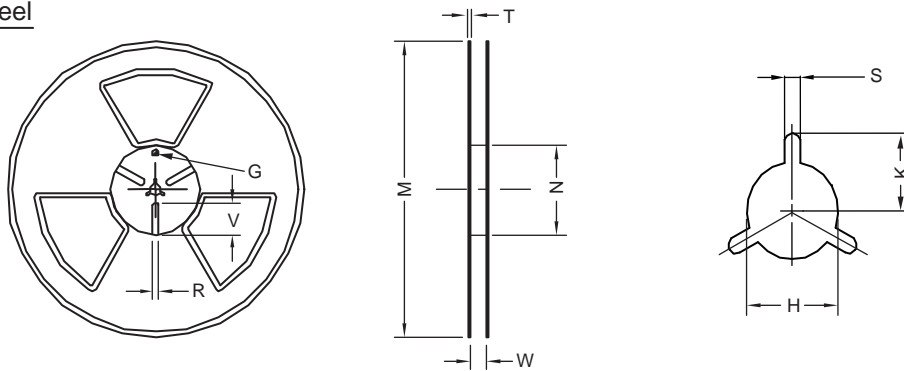

UNIT:mm

TAPE SIZE	REEL SIZE	M	N	W	T	H	K	S	G	R	V
16 mm	φ 330	φ 330 ± 0.5	φ 97 ± 1.0	17.0 + 1.5 - 0	2.2	φ 13.0 + 0.5 - 0.2	10.6	2.0 ±0.5	---	---	---