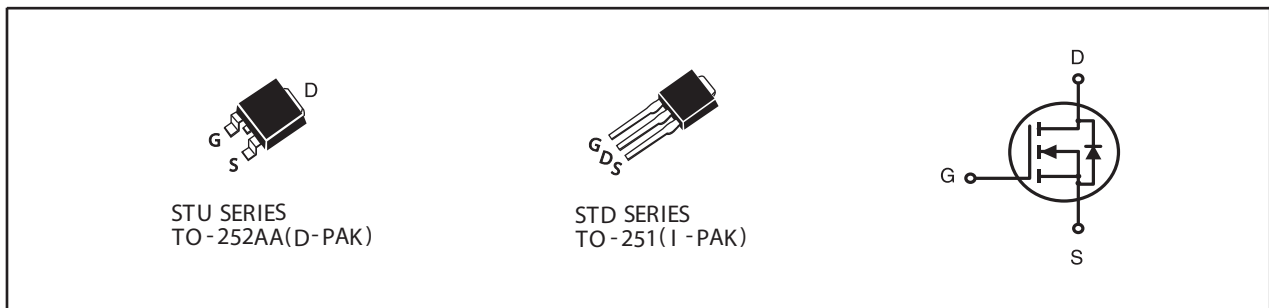

**N-Channel Logic Level Enhancement Mode Field Effect Transistor****PRODUCT SUMMARY**

V _{DSS}	I _D	R _{DS(ON)} (mΩ) Max
40V	30A	24 @ V _{GS} =10V
		36 @ V _{GS} =4.5V

FEATURES

- Super high dense cell design for low R_{DS(ON)}.
- Rugged and reliable.
- TO-252 and TO-251 Package.

**ABSOLUTE MAXIMUM RATINGS (T_A=25°C unless otherwise noted)**

Symbol	Parameter	Limit	Units
V _{DS}	Drain-Source Voltage	40	V
V _{GS}	Gate-Source Voltage	±20	V
I _D	Drain Current-Continuous ^a	T _C =25°C	30
		T _C =70°C	24
I _{DM}	-Pulsed ^b	88	A
E _{AS}	Single Pulse Avalanche Energy ^d	30	mJ
P _D	Maximum Power Dissipation ^a	T _C =25°C	42
		T _C =70°C	27
T _J , T _{STG}	Operating Junction and Storage Temperature Range	-55 to 150	°C

THERMAL CHARACTERISTICS

R _{θJC}	Thermal Resistance, Junction-to-Case ^a	3	°C/W
R _{θJA}	Thermal Resistance, Junction-to-Ambient ^a	50	°C/W

STU/D456S

Ver 1.0

ELECTRICAL CHARACTERISTICS (T_A=25°C unless otherwise noted)

Symbol	Parameter	Conditions	Min	Typ	Max	Units
OFF CHARACTERISTICS						
BV _{DSS}	Drain-Source Breakdown Voltage	V _{GS} =0V , I _D =250uA	40			V
I _{DSS}	Zero Gate Voltage Drain Current	V _{DS} =32V , V _{GS} =0V			1	uA
I _{GSS}	Gate-Body Leakage Current	V _{GS} = ±20V , V _{DS} =0V			±100	nA
ON CHARACTERISTICS						
V _{GS(th)}	Gate Threshold Voltage	V _{DS} =V _{GS} , I _D =250uA	1	1.7	3	V
R _{DS(ON)}	Drain-Source On-State Resistance	V _{GS} =10V , I _D =15A		19	24	m ohm
		V _{GS} =4.5V , I _D =12A		27	36	m ohm
g _{FS}	Forward Transconductance	V _{DS} =10V , I _D =15A		34		S
DYNAMIC CHARACTERISTICS ^c						
C _{ISS}	Input Capacitance	V _{DS} =20V, V _{GS} =0V f=1.0MHz		705		pF
C _{OSS}	Output Capacitance			79		pF
C _{RSS}	Reverse Transfer Capacitance			61		pF
SWITCHING CHARACTERISTICS ^c						
t _{D(ON)}	Turn-On Delay Time	V _{DD} =20V I _D =1A V _{GS} =10V R _{GEN} = 6 ohm		13.3		ns
t _r	Rise Time			11.5		ns
t _{D(OFF)}	Turn-Off Delay Time			18		ns
t _f	Fall Time			22		ns
Q _g	Total Gate Charge	V _{DS} =20V, I _D =15A, V _{GS} =10V		11.5		nC
		V _{DS} =20V, I _D =15A, V _{GS} =4.5V		5.5		nC
Q _{gs}	Gate-Source Charge	V _{DS} =20V, I _D =15A, V _{GS} =10V		1.5		nC
Q _{gd}	Gate-Drain Charge			3.2		nC
DRAIN-SOURCE DIODE CHARACTERISTICS AND MAXIMUM RATINGS						
V _{SD}	Diode Forward Voltage ^b	V _{GS} =0V, I _S =1A		0.76	1.3	V
Notes						
a.Surface Mounted on FR4 Board, t ≤ 10sec.						
b.Pulse Test:Pulse Width ≤ 300us, Duty Cycle ≤ 2%.						
c.Guaranteed by design, not subject to production testing.						
d.Starting T _J =25°C, L=0.5mH, V _{DD} = 20V.(See Figure13)						

Mar,23,2010

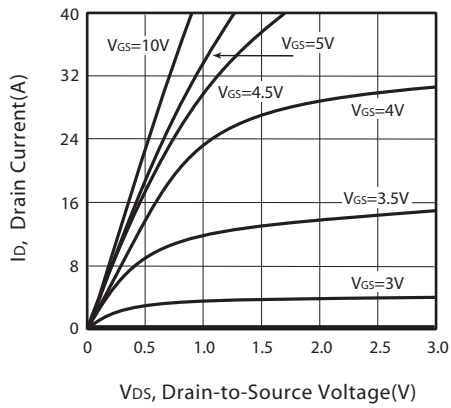

Figure 1. Output Characteristics

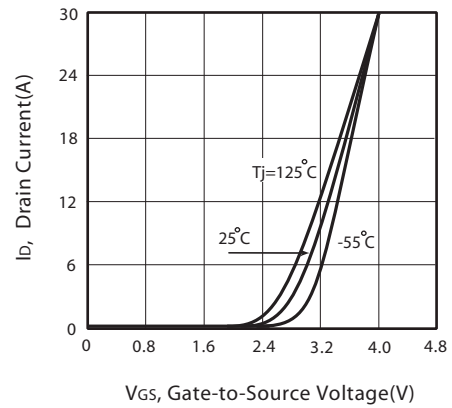

Figure 2. Transfer Characteristics

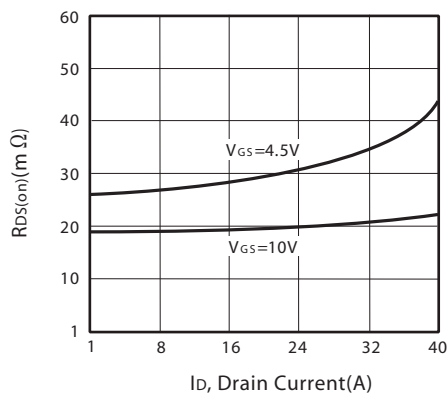

Figure 3. On-Resistance vs. Drain Current and Gate Voltage

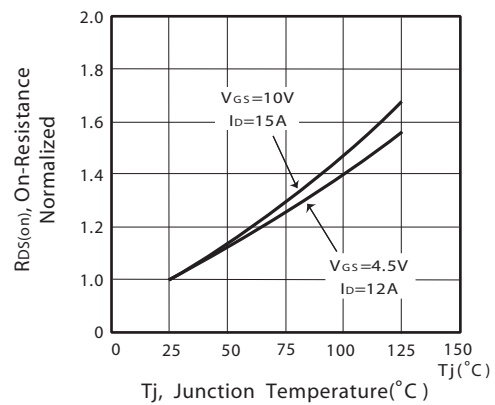

Figure 4. On-Resistance Variation with Drain Current and Temperature

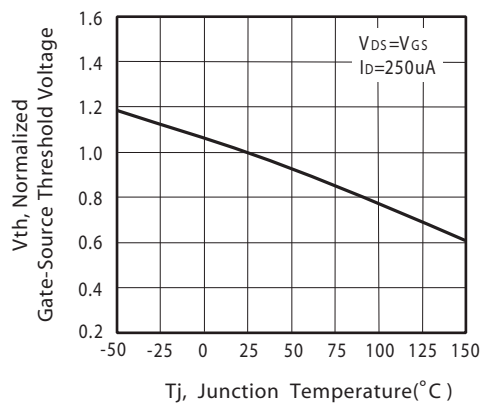

Figure 5. Gate Threshold Variation with Temperature

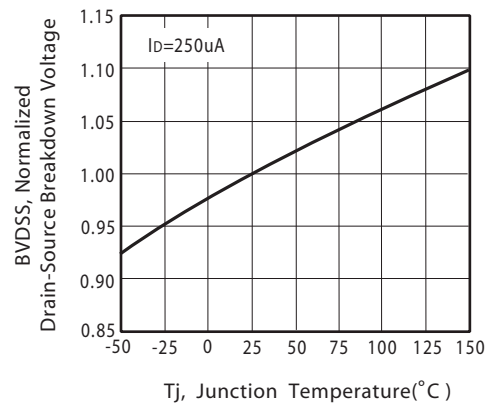

Figure 6. Breakdown Voltage Variation with Temperature

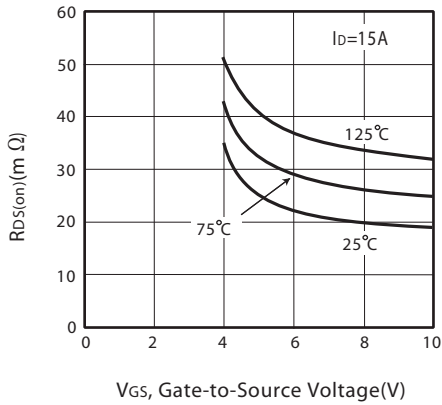

Figure 7. On-Resistance vs. Gate-Source Voltage

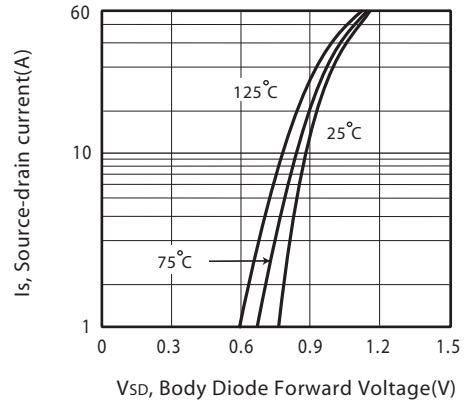

Figure 8. Body Diode Forward Voltage Variation with Source Current

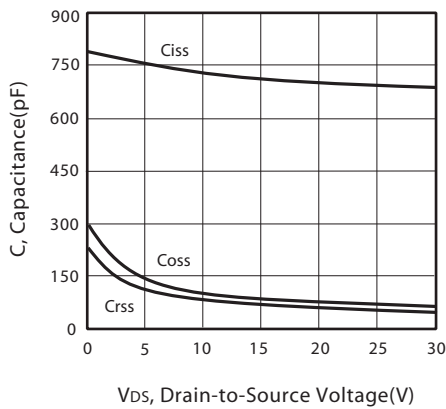

Figure 9. Capacitance

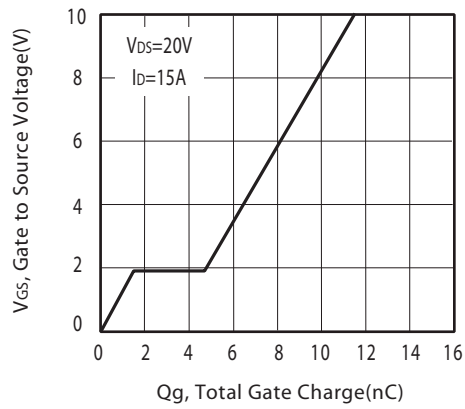

Figure 10. Gate Charge

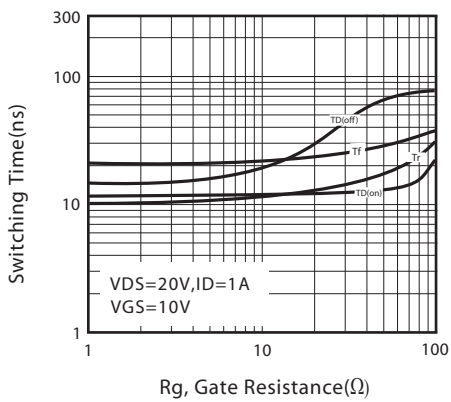

Figure 11. switching characteristics

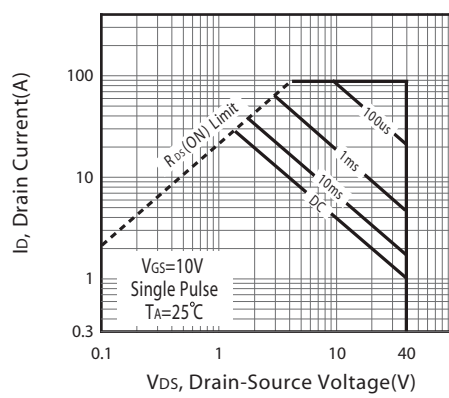
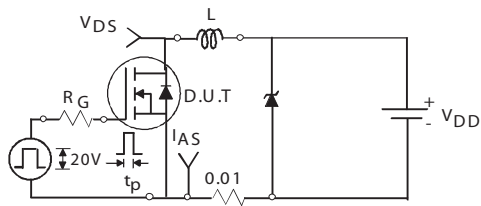
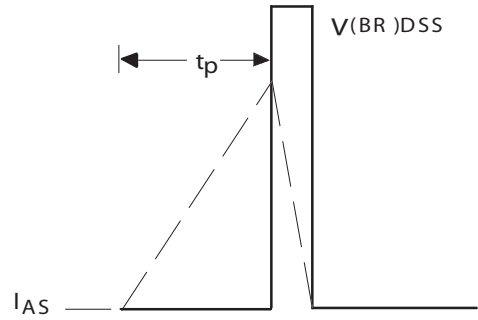

Figure 12. Maximum Safe Operating Area



Unclamped Inductive Test Circuit

Figure 13a.



Unclamped Inductive Waveforms

Figure 13b.

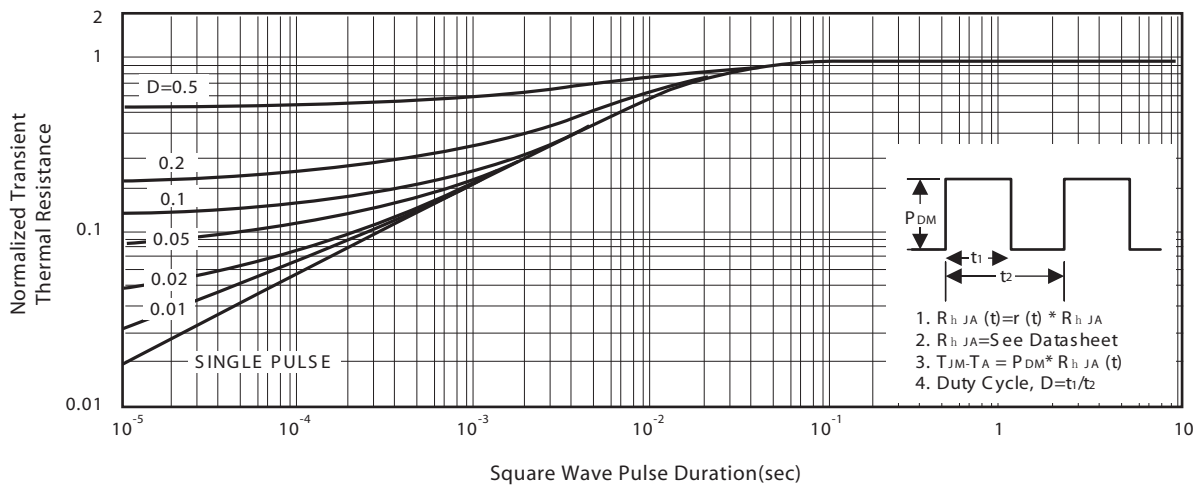
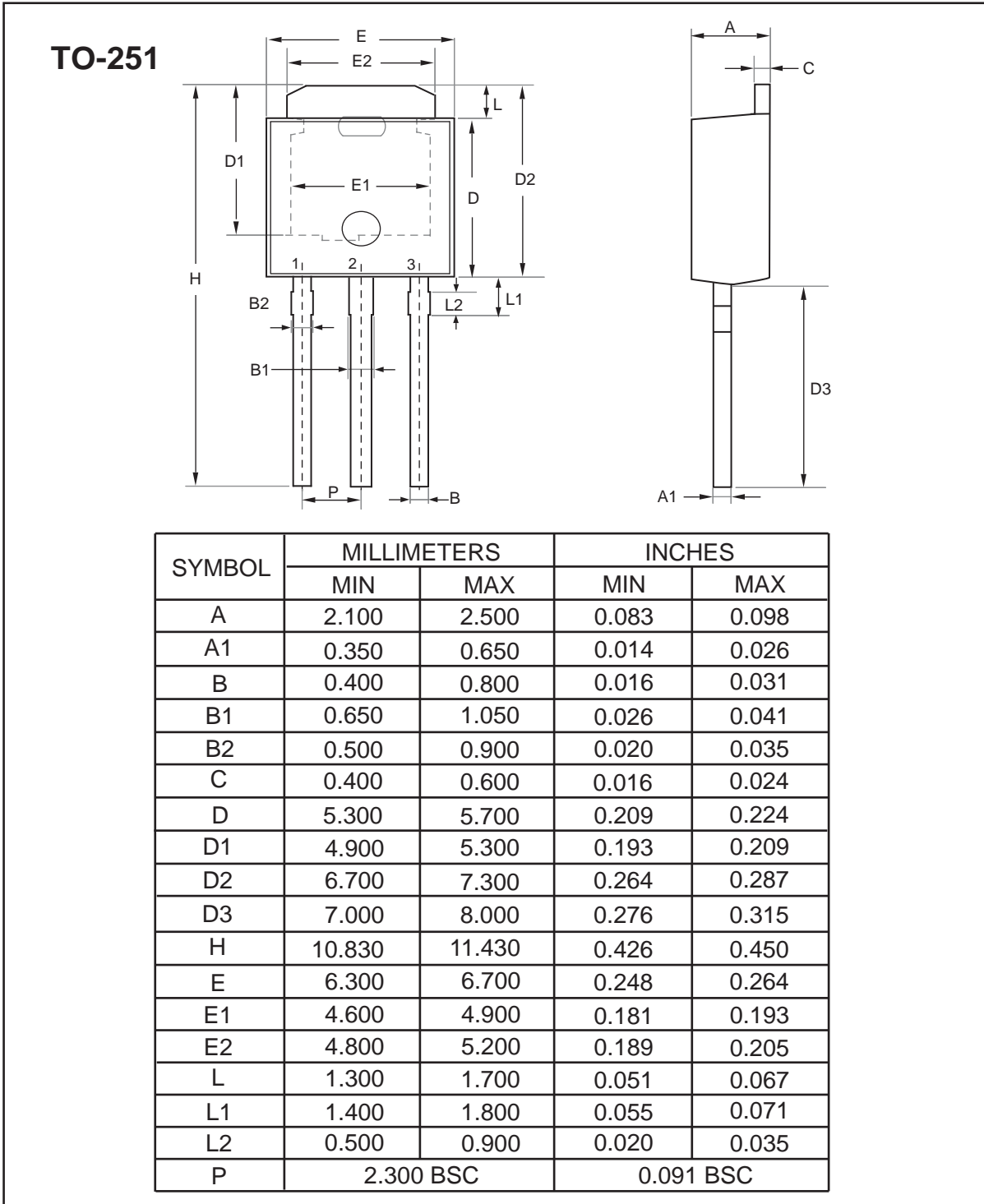

Figure 14. Normalized Thermal Transient Impedance Curve

STU/D456S

Ver 1.0

PACKAGE OUTLINE DIMENSIONS



Mar,23,2010

STU/D456S

Ver 1.0

TO-252

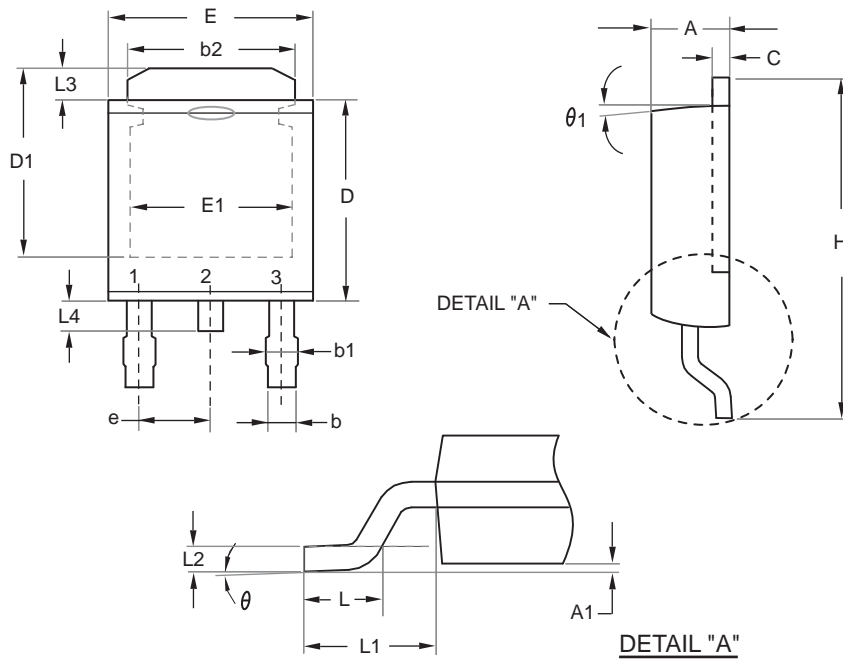

SYMBOLS	MILLIMETERS		INCHES	
	MIN	MAX	MIN	MAX
A	2.100	2.500	0.083	0.098
A1	0.000	0.200	0.000	0.008
b	0.400	0.889	0.016	0.035
b1	0.770	1.140	0.030	0.045
b2	4.800	5.460	0.189	0.215
C	0.400	0.600	0.016	0.024
D	5.300	6.223	0.209	0.245
D1	4.900	5.515	0.193	0.217
E	6.300	6.731	0.248	0.265
E1	4.400	5.004	0.173	0.197
e	2.290 REF		0.090 BSC	
H	8.900	10.400	0.350	0.409
L	1.397	1.770	0.055	0.070
L1	2.743 REF.		0.108 REF.	
L2	0.508 REF.		0.020 REF.	
L3	0.890	1.700	0.035	0.067
L4	0.500	1.100	0.020	0.043
theta	0°	10°	0°	10°
theta1	7° REF.		7° REF.	

Mar,23,2010

TO-251 Tube/TO-252 Tape and Reel Data

TO-251 Tube

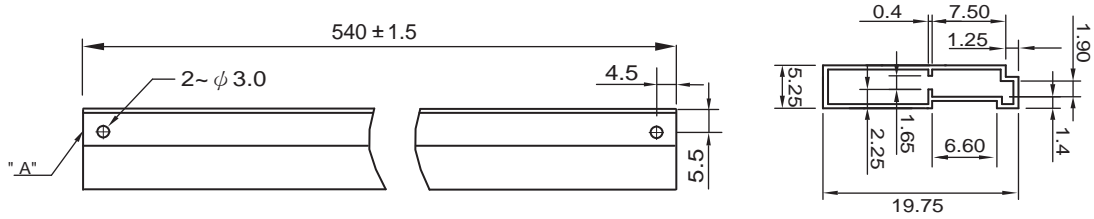

TO-252 Carrier Tape

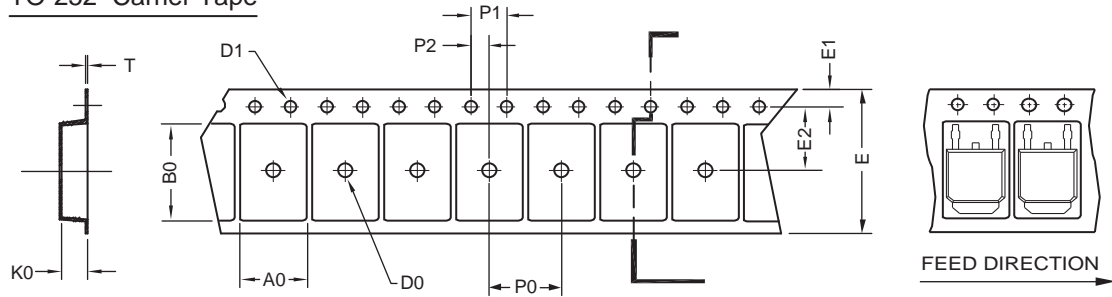

UNIT:mm

PACKAGE	A0	B0	K0	D0	D1	E	E1	E2	P0	P1	P2	T
TO-252 (16 mm)	6.96 ±0.1	10.49 ±0.1	2.79 ±0.1	φ 2	φ 1.5 + 0.1 - 0	16.0 ±0.3	1.75 ±0.1	7.5 ±0.15	8.0 ±0.1	4.0 ±0.1	2.0 ±0.15	0.3 ±0.05

TO-252 Reel

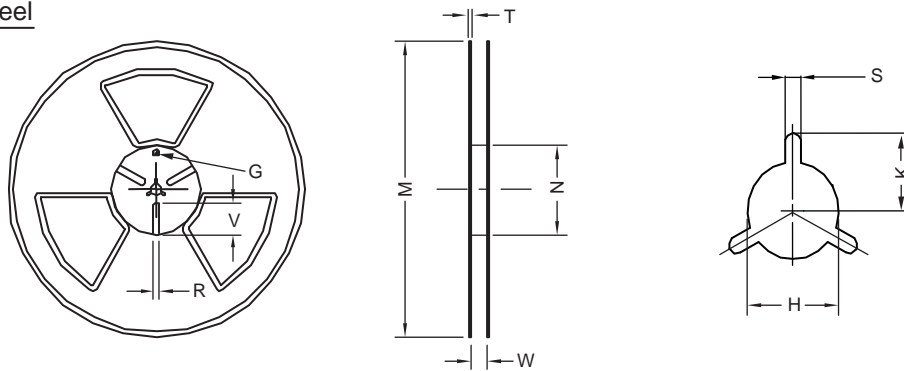

UNIT:mm

TAPE SIZE	REEL SIZE	M	N	W	T	H	K	S	G	R	V
16 mm	φ 330	φ 330 ± 0.5	φ 97 ± 1.0	17.0 + 1.5 - 0	2.2	φ 13.0 + 0.5 - 0.2	10.6	2.0 ±0.5	---	---	---