



## DEFLECTION PROCESSOR FOR MULTISYNC MONITOR

### HORIZONTAL

- DUAL PLL CONCEPT
- SELF-ADAPTIVE (30 TO 70kHz)
- X-RAY PROTECTION INPUT
- DC ADJUSTABLE DUTY-CYCLE
- INTERNAL 1st PLL LOCK/UNLOCK IDENTIFICATION
- WIDE RANGE DC CONTROLLED H-POSITION
- ON/OFF SWITCH (FOR PWR MANAGEMENT)
- TWO H-DRIVE POLARITIES

### VERTICAL

- VERTICAL RAMP GENERATOR
- 45 TO 120Hz AGC LOOP
- DC CONTROLLED V-AMP, V-POS, S-AMP AND S-CENTERING
- ON/OFF SWITCH

### B+ REGULATOR

- INTERNAL PWM GENERATOR FOR B+ CURRENT MODE STEP-UP CONVERTER
- DC ADJUSTABLE B+ VOLTAGE
- OUTPUT PULSES SYNCHRONISED ON HORIZONTAL FREQUENCY
- INTERNAL MAX CURRENT LIMITATION

### EWPC

- VERTICAL PARABOLA GENERATOR WITH DC CONTROLLED KEYSTONE AND AMPLITUDE

### GENERAL

- COMPARED WITH THE STV7778, THE STV7778S HAS AN INTERNAL METAL SHIELD PROTECTION AGAINST OVERVOLTAGE.
- POS/NEG H AND V SYNC POL
- SEPARATED H AND V TTL INPUT
- SAFETY BLANKING OUTPUT

### DESCRIPTION

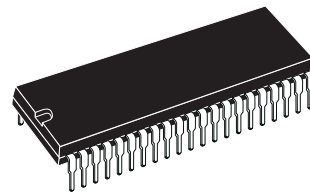
The STV7778S is a monolithic integrated circuit assembled in a 42 pins shrunk dual in line plastic package.

The goal of this IC is to control all the functions related to the horizontal and vertical deflection in a multimodes or multisync monitor.

As can be seen in the block diagram, the STV7778S includes the following functions :

- Positive or Negative sync polarities,
- Auto-sync horizontal processing,
- H-PLL lock/unlock identification,
- Auto-sync Vertical processing,
- East/West signal processing block,
- B+ controller,
- Safety blanking output.

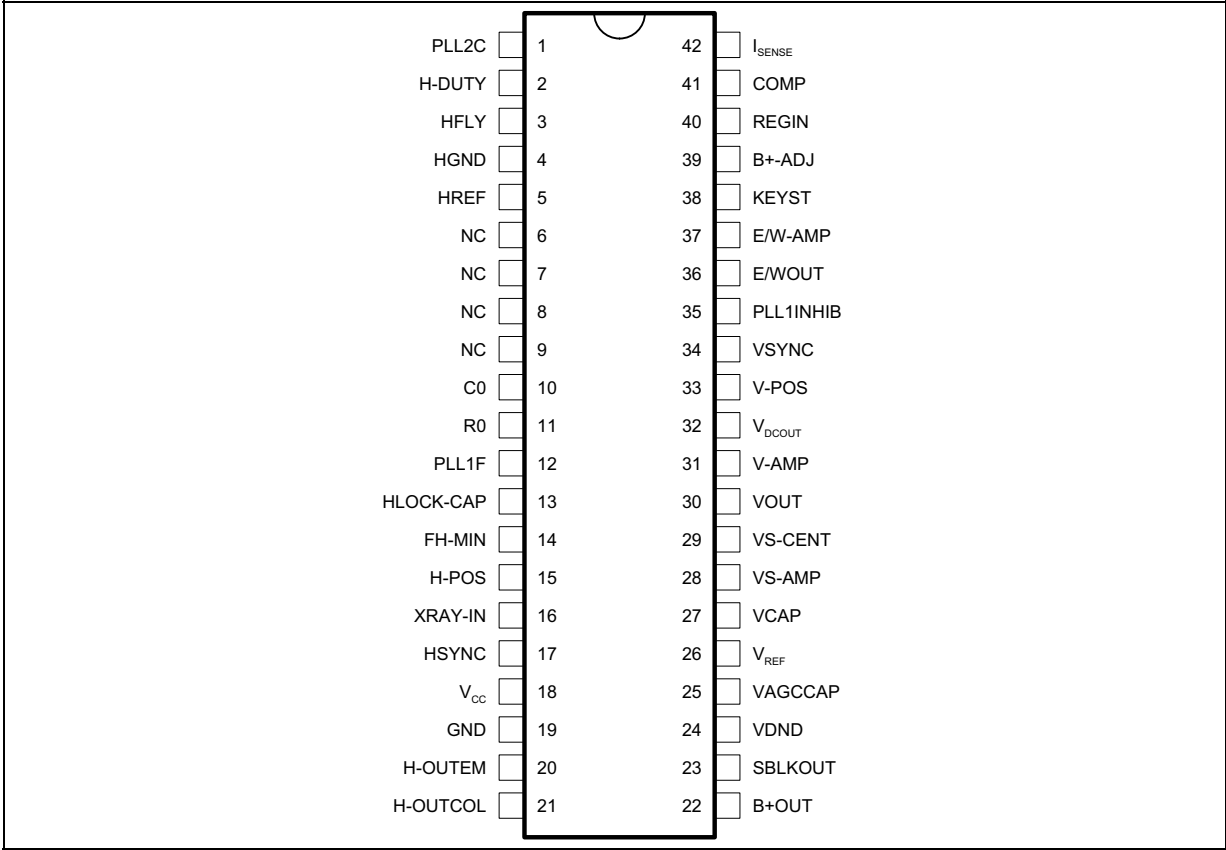
An internal metal shield give to the STV7778S more immunity against electromagnetic and electrostatic fields, and therefore, additional safety for critical applications (for example, in case of CRTs with small coated area).



**SHRINK42**  
(Plastic Package)

**ORDER CODE : STV7778S**

PIN CONNECTIONS



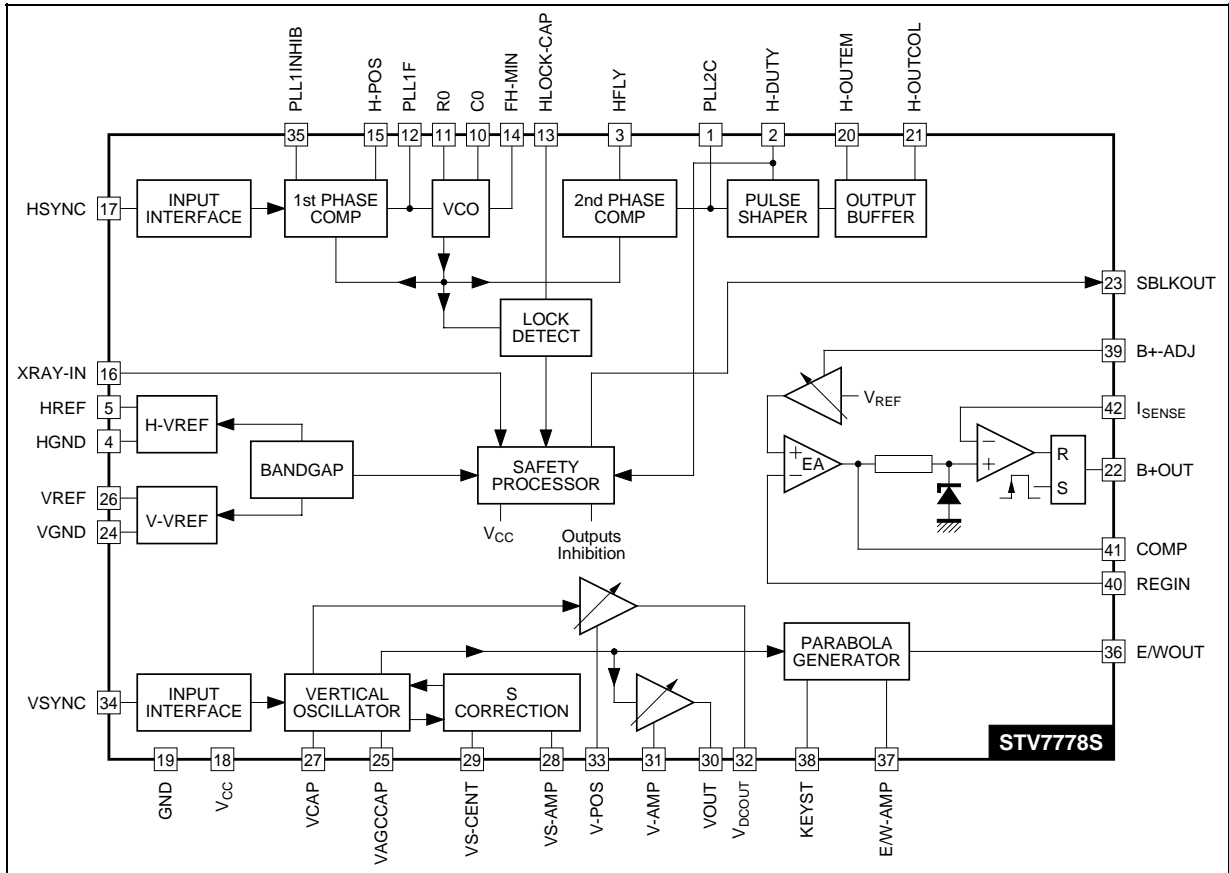
7778S-01.EPS

## PIN-OUT DESCRIPTION

Pin N°	Name	Function
1	PLL2C	Second PLL Loop Filter
2	H-DUTY	DC Control of Horizontal Drive Output Pulse Duty-cycle. If this pin is grounded, the horizontal and vertical outputs are inhibited. By connecting a capacitor on this pin a soft-start function may be realized on h-drive output.
3	H-FLY	Horizontal Flyback Input (Positive Polarity)
4	H-GND	Horizontal Section Ground. Must be connected only to components related to H blocks.
5	H-REF	Horizontal Section Reference Voltage. Must be filtered by capacitor to Pin 4
6	NC	
7	NC	
8	NC	
9	NC	
10	C0	Horizontal Oscillator Capacitor. To be connected to Pin 4.
11	R0	Horizontal Oscillator Resistor. To be connected to Pin 4.
12	PLL1F	First PLL Loop Filter. To be connected to Pin 4.
13	HLOCK-CAP	First PLL Lock/Unlock Time Constant Capacitor. Capacitor filtering the frequency change detected on Pin13. When frequency is changing, a blanking pulse is generated on Pin 23, the duration of this pulse is proportionnal to the capacitor on Pin 13. To be connected to Pin 4.
14	FH-MIN	DC Control for Free Running Frequency Setting. Comming from DAC output or DC voltage generated by a resistor bridge connected between Pin 5 and 4.
15	H-POS	DC Control for Horizontal Centering
16	XRAY-IN	X-RAY Protection Input (with internal latch function)
17	H-SYNC	TTL Horizontal Sync Input
18	V <sub>CC</sub>	Supply Voltage (12V Typical)
19	GND	Ground
20	H-OUTEM	Horizontal Drive Output (emiter of internal transistor)
21	H-OUTCOL	Horizontal Drive Output (open collector of internal transistor)
22	B+ OUT	B+ PWM Regulator Output
23	SBLK OUT	Safety Blanking Output. Activated during frequency changes, when X-RAY input is triggered or when VS is too low.
24	VGND	Vertical Section Signal Ground
25	VAGCCAP	Memory Capacitor for Automatic Gain Control Loop in Vertical Ramp Generator
26	V <sub>REF</sub>	Vertical Section Reference Voltage
27	VCAP	Vertical Sawtooth Generator Capacitor
28	VS-AMP	DC Control of Vertical S Shape Amplitude
29	VS-CENT	DC Control of Vertical S Centering
30	VOUT	Vertical Ramp Output (with frequency independant amplitude and S-correction)
31	V-AMP	DC Control of Vertical Amplitude Adjustment
32	V <sub>DCOUT</sub>	Vertical Position Reference Voltage Output Temperature Matched with V-AMP Output
33	V-POS	DC Control of Vertical Position Adjustment
34	VSYNC	Vertical TTL Sync Input
35	PLL1INHIB	TTL Input for PLL1 Output Current Inhibition (To be used in case of comp sync input signal)
36	E/WOUT	East/West Pincushion Correction Parabola Output
37	E/W-AMP	DC Control of East/West Pincushion Correction Amplitude
38	KEYST	DC Control of Keystone Correction
39	B+ ADJ	DC Control of B+ Adjustment
40	REGIN	Regulation Input of B+ Control Loop
41	COMP	B+ Error Amplifier Output for Frequency Compensation and Gain Setting
42	I <sub>SENSE</sub>	Sensing of External B+ Switching Transistor Emitter Current

7778S-01.TBL

BLOCK DIAGRAM



7778S-02.EPS

**ABSOLUTE MAX RATING**

Symbol	Parameter	Value	Unit
V <sub>CC</sub>	Supply Voltage (Pin 18)	13.5	V
V <sub>IN</sub>	Max Voltage on Pins 2, 14, 15, 28, 29, 31, 33, 37, 38, 39 Pin 3 Pins 17, 34 Pin 40 Pin 42 Pin 16	8 1.8 6 8 8 6	V
VESD	ESD Susceptibility Human Body Model, 100pF Discharge through 1.5kΩ EIAJ Norm, 200pF Discharge through 0Ω	2 300	kV V
T <sub>stg</sub>	Storage Temperature	-40, +150	°C
T <sub>j</sub>	Max Operating Junction Temperature	150	°C
T <sub>oper</sub>	Operating Temperature	0, +70	°C

7778S-02.TBL

**THERMAL DATA**

Symbol	Parameter	Value	Unit
R <sub>th(j-a)</sub>	Junction-Ambient Thermal Resistance	Max. 65	°C/W

7778S-03.TBL

**HORIZONTAL SECTION****Operating conditions**

Symbol	Parameter	Test conditions	Min.	Typ.	Max.	Unit
VCO						
R0min	Oscillator Resistor Min Value	Pin 11	6			kΩ
C0min	Oscillator Capacitor Min Value	Pin 10	390			pF
Fmax	Maximum Oscillator Frequency				70	kHz
HsVR	Horizontal Sync Input Voltage	Pin 17	0		5.5	V

**INPUT SECTION**

MinD	Minimum Input Pulses Duration	Pin 17	1			μS
Mduty	Maximum Input Signal Duty Cycle	Pin 17			25	%

**OUTPUT SECTION**

I3m	Maximum Input Peak Current on Pin 3				2	mA
HOI1	Horizontal Drive Output Max Current	Pin 20, sourced current			20	mA
HOI2	Horizontal Drive Output Max Current	Pin 21, sunk current			20	mA

**DC CONTROL VOLTAGES**

DCadj	DC Voltage Range on DC Controls	V <sub>REF-H</sub> = 8V, Pins 2-14-15	2		6	V
-------	---------------------------------	---------------------------------------	---	--	---	---

7778S-04.TBL

**HORIZONTAL SECTION** (continued)**Electrical Characteristics** ( $V_{CC} = 12V$ ,  $T_{amb} = 25^{\circ}C$ )

Symbol	Parameter	Test conditions	Min.	Typ.	Max.	Unit
--------	-----------	-----------------	------	------	------	------

## SUPPLY AND REFERENCE VOLTAGES

$V_{CC}$	Supply Voltage	Pin 18	10.8	12	13.2	V
$I_{CC}$	Supply Current	Pin 18, See Figure 1		40	60	mA
$V_{REF-H}$	Reference Voltage for Horizontal Section	Pin 5	7.4	8	8.6	V
$I_{REF-H}$	Max Sourced Current on $V_{REF-H}$	Pin 5			2	mA
$V_{REF-V}$	Reference Voltage for Vertical Section	Pin 26	7.4	8	8.6	V
$I_{REF-V}$	Max Sourced Current on $V_{REF-V}$	Pin 26			2	mA

## INPUT SECTION/PLL1

$V_{INTH}$	Hor Input Threshold Voltage Pin 17	Low level voltage High level voltage	2		0.8	V V
$V_{VCO}$	VCO Control Voltage	$V_{REF-H} = 8V$ , Pin 12	1.6		6.2	V
VCOG	VCO Gain, dF/dV Pin 12	$R_0 = 6.49k\Omega$ , $C_0 = 680pF$		15		kHz/V
Hph	Horizontal Phase Adjustment (Pin 15)	% of Hor period		$\pm 10$		%
FFadj	Free Running Frequency Adjustment (Pin 14)	Without H-sync Signal		$\pm 20$		%
CR	PLL1 Capture Range ( $F_0 = 27kHz$ ) Fh Min Fh Max	See conditions on Figure 1	70		28	kHz kHz
PLLinh	PLL 1 Inhibition (Pin 35) PLL ON PLL OFF	$V_{35}$ $V_{35}$	2		0.8	V

## SECOND PLL AND HORIZONTAL OUTPUT SECTION

FBth	Flyback Input Threshold Voltage	Pin 3	0.65	0.75		V
Hjit	Horizontal Jitter				150	ppm
HDmin	Minimum Hor Drive Output Duty-cycle	Pin 20 or 21, $V_2 = 2V$	45	30	35	%
HDmin	Maximum Hor Drive Output Duty-cycle	Pin 20 or 21, $V_2 = 6V$		50		%
HDvd	Horizontal Drive Low Level Output Voltage	$V_{21-V20}$ , $I_{out} = 20mA$ , Pin 20 to GND		1.1	1.7	V
HDem	Horizontal Drive High Level Output Voltage (output on Pin 20)	Pin 21 to $V_{CC}$ , $I_{OUT} = 20mA$	9.5	10		V
XRAYth	X-RAY Protection Input Threshold Voltage	Pin 16		1.6	1.8	V
ISblkO	Maximum Output Current on Safety Blanking Output	$I_{23}$			10	mA
VSblkO	Low-Level Voltage on Safety Blanking Output	$V_{23}$ with $I_{23} = 10mA$		0.25	0.5	V
Vphi2	Internal Clamping Voltage on 2nd PLL Loop Filter Output (Pin 1)	$V_{min}$ $V_{max}$		1.6 3.2		V V
$V_{OFF}$	Pin 2 Threshold Voltage to Stop H-out, V-out B+out and to Activate S-BLK.OFF Mode when $V_2 < V_{OFF}$	$V_2$		1		V

7778S-06.TBL

**B+ SECTION****Operating Conditions**

Symbol	Parameter	Test conditions	Min.	Typ.	Max.	Unit
EAOI	Maximum Error Amplifier Output Current	Sourced by Pin 41 Sunk by Pin 41			0.5 2	mA mA
FeedRes	Minimum Feedback Resistor	Resistor between Pins 40 and 41	5			kΩ

7778S-06.TBL

**Electrical Characteristics** ( $V_{CC} = 12V$ ,  $T_{amb} = 25^{\circ}C$ )

Symbol	Parameter	Test conditions	Min.	Typ.	Max.	Unit
OLG	Error Amplifier Open Loop Gain	At low frequency (see Note 1)		85		dB
UGBW	Unity Gain Bandwidth	(see Note 1)		6		MHz
IRI	Regulation Input Bias Current	Current sourced by Pin 40 (PNP base)		0.2		μA
EAOI	Maximum Guaranteed Error Amplifier Output Current	Current sourced by Pin 41 Current sink by Pin 41	0.5 2			mA mA
CSG	Current Sense Input Voltage Gain	Pin 42		3		
MCEth	Max Current Sense Input Threshold Voltage	Pin 42		1.2		V
ISI	Current Sense Input Bias Current	Current sunk by Pin 42 (NPN base)		1		μA
Tonmax	Maximum External Power Transistor on Time	% of H-period, @ $f_0 = 27kHz$		75		%
B+OSV	B+ Output Low Level Saturation Voltage	$V_{22}$ with $I_{22} = 10mA$		0.25		V
IVref	Internal Reference Voltage	On error amp (+) input for $V_{39} = 4V$		4.9		V
VREFADJ	Internal Reference Voltage Adjustment	$2V < V_{39} < 6V$		±14		%

7778S-07.TBL

**EAST WEST PARABOLA GENERATOR****Electrical Characteristics** ( $V_{CC} = 12V$ ,  $T_{amb} = 25^{\circ}C$ )

Symbol	Parameter	Test conditions	Min.	Typ.	Max.	Unit
Vsym	Parabola Symetry Adjustment Capability (for Keystone Adjustment ; with Pin 38)	See Figure 2 ; Internal voltage $V_{38} = 2V$ $V_{38} = 4V$ $V_{38} = 6V$		3.2 3.5 3.8		V
Kadj	Keystone Adjustment Capability B/A ratio A/B ratio	See Figure 2 ; $V_{37} = 4V$ $V_{38} = 2V$ $V_{38} = 6V$		2.3 2.0		
Paramp	Parabola Amplitude Adjustment Capability Maximum Amplitude on Pin 36 Maximum Ratio between Max and Min	$V_{38} = 4.3V$ , $V_{28} = 2V$ $V_{37} = 2V$ $2V < V_{37} < 6V$	3.3 2.4	3.8 3	4.3	V

7778S-08.TBL

**VERTICAL SECTION**  
**Operating Conditions**

Symbol	Parameter	Test conditions	Min.	Typ.	Max.	Unit
VSVR	Vertical Sync Input Voltage	On Pin 34	0		5.5	V

7778S-09.TBL

**Electrical Characteristics** ( $V_{CC} = 12V$ ,  $T_{amb} = 25^{\circ}C$ )

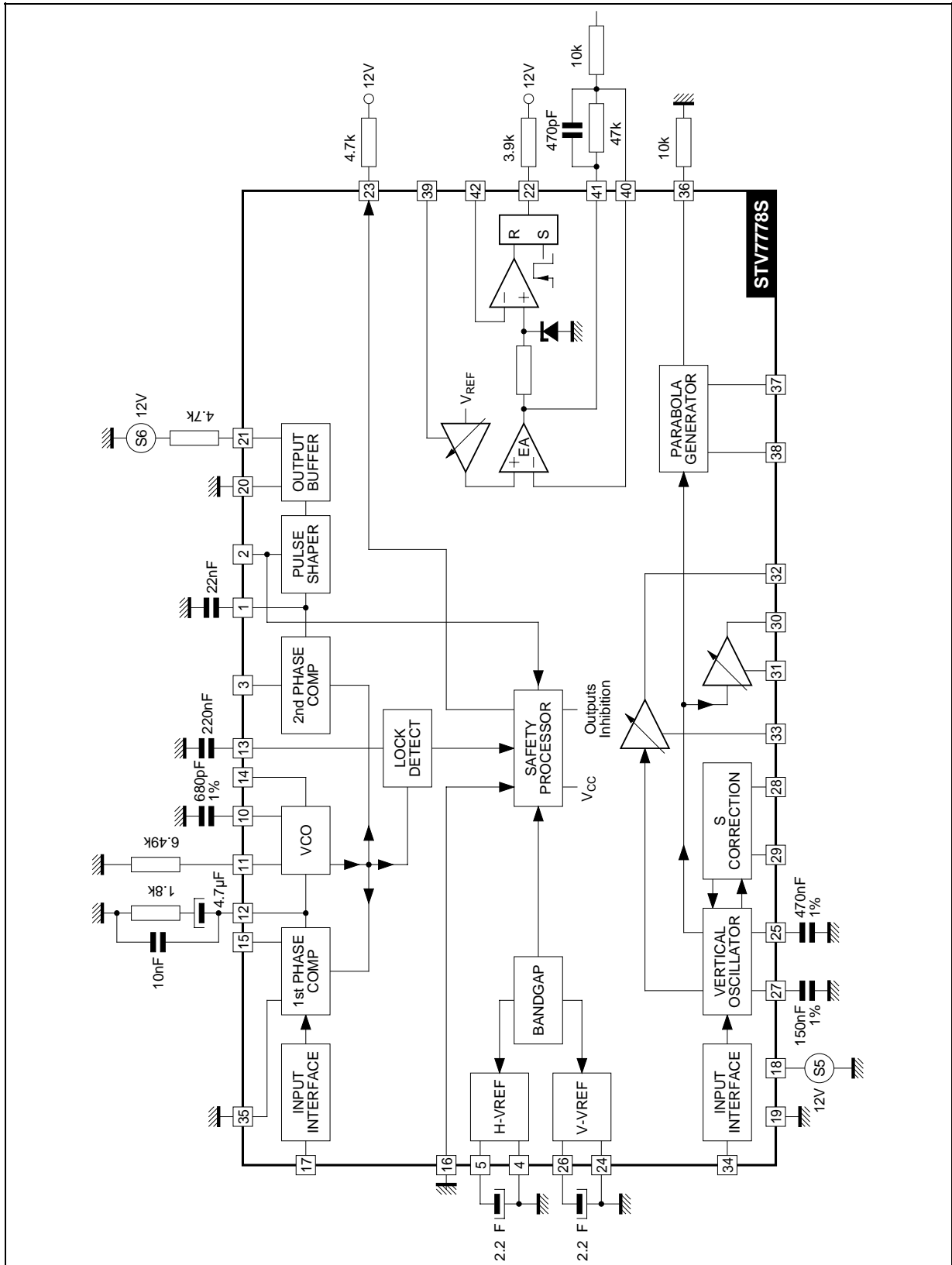
Symbol	Parameter	Test conditions	Min.	Typ.	Max.	Unit
I <sub>BIASP</sub>	Pin 23-28-29 Bias Current (Current sourced by PNP base)	For $V_{23-28-29} = 2V$		2		$\mu A$
I <sub>BIASN</sub>	Pin 31 Bias Current (Current sunk by NPN base)	For $V_{31} = 6V$		0.5		$\mu A$
V <sub>StH</sub>	Vertical Sync Input Threshold Voltage	Pin 34; High-level Low-level	2		0.8	V V
V <sub>SBI</sub>	Vertical Sync Input Bias Current (Current Sourced by PNP Base)	$V_{34} = 0.8V$		1		$\mu A$
V <sub>RB</sub>	Voltage at Ramp Bottom Point	On Pin 27		2/8		$V_{REF-V}$
V <sub>RT</sub>	Voltage at Ramp Top Point (with Sync)	On Pin 27		5/8		$V_{REF-V}$
V <sub>RTF</sub>	Voltage at Ramp Top Point (without Sync)	On Pin 27		VRT-0.1		V
I <sub>R27</sub>	Output Current Range on Pin 27 during Ramp Charging Time. Current to Charge Capacitor between Pin 27 and Ground	$V_{28} = 2V$ (Note 2), $2V < V_{27} < 5V$ Min current Max current	100	15 135	20	$\mu A$ $\mu A$
V <sub>SW</sub>	Minimum Vertical Sync Pulse Width	Pin 34	5			$\mu S$
V <sub>SmDut</sub>	Vertical Sync Input Maximum Duty-cycle	Pin 34			15	%
V <sub>STD</sub>	Vertical Sawtooth Discharge Time Duration	On Pin 27, with 150nF cap		85		$\mu S$
V <sub>FRF</sub>	Vertical Free Running Frequency ( $V_{28} = 2V$ )	Measured on Pin 27, Cosc (Pin27) = 150nF		100		Hz
A <sub>FR</sub>	AUTO-SYNC Frequency (see Note 3)	With $C_{27} = 150nF \pm 5\%$	50		120	Hz
R <sub>ATD</sub>	Ramp Amplitude Thermal Drift	On Pin 30 (see Note 1), ( $0^{\circ}C < T_{amb} < 70^{\circ}C$ )		100		ppm/ $^{\circ}C$
R <sub>AFD</sub>	Ramp Amplitude Drift Versus Frequency	$V_{31} = 6V$ , $C_{27} = 150nF$ , $50Hz < F < 120Hz$		200		ppm/Hz
R <sub>lin</sub>	Ramp Linearity on Pin 27 $\Delta I_{27}/I_{27}$	$V_{28} = 2V$ , $V_{25} = X = 4.3V$ , $2.5V < V_{27} < 4.5V$		0.5		%
R <sub>load</sub>	Minimum Load on Pin 25 for less than 1% Vertical Amplitude Drift		50			M $\Omega$
V <sub>pos</sub>	Vertical Position Adjustment Voltage on Pin 32	$V_{33} = 2V$ $V_{33} = 4V$ $V_{33} = 6V$	3.65	3.2 3.5 3.8	3.3	V V V
I <sub>VPOS</sub>	Max Current on Vertical Position Control Output (Pin 32)			$\pm 2$		mA
V <sub>or</sub>	Vertical Output Voltage (on Pin 30) (Peak to Peak Voltage on Pin 30)	$V_{31} = 2V$ $V_{31} = 4V$ $V_{31} = 6V$	3.75	2 3 4	2.2	V V V
V <sub>OUTDC</sub>	DC Voltage on Vertical Output (Pin30)	See Note 4		7/16		$V_{REF-V}$
V <sub>OI</sub>	Vertical Output Maximum Output Current	On Pin 30		$\pm 5$		mA
d <sub>VS</sub>	Max Vertical S-Correction Amplitude ( $V_{28} = 2V$ Inhibits S-CORR; $V_{28} = 6V$ gives Maximum S-CORR) (see Figure 3)	$\Delta V/V_{30pp}$ at T/4 $\Delta V/V_{30pp}$ at 3T/4		-4 +4		% %
C <sub>corr</sub>	C-Correction Adjustment Range Voltage on Pin 27 for Maximum Slope on the Ramp (with S-Correction) (see Figure 4)	$V_{29} = 2V$ $V_{29} = 4V$ $V_{29} = 6V$		3 3.5 4		V V V

7778S-10.TBL

- Notes :**
1. These parameters are not tested on each unit. They are measured during our internal qualification procedure which includes characterization on batches coming from corners of our processes and also temperature characterization.
  2. When 2V are applied on Pin 28 (Vertical S-Correction control), then the S-Correction is inhibited, consequently the sawtooth have a linear shape.
  3. It is the frequency range for which the VERTICAL OSCILLATOR will automatically synchronize, using a single capacitor value on Pin 27 and with a constant ramp amplitude.
  4. Typically 3.5V for Vertical reference voltage typical value (8V).

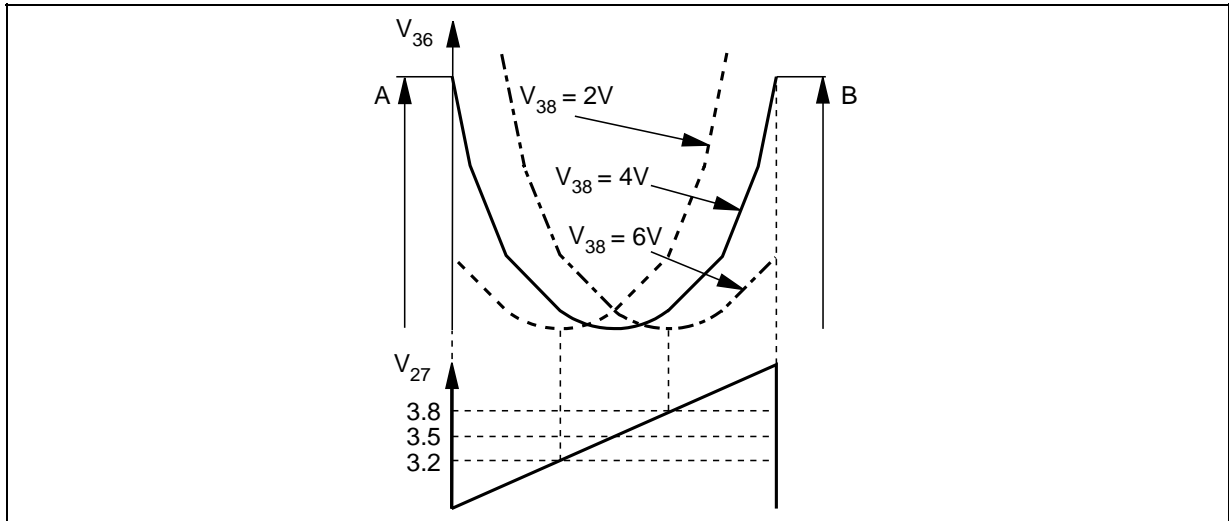


Figure 1 : Testing Circuit



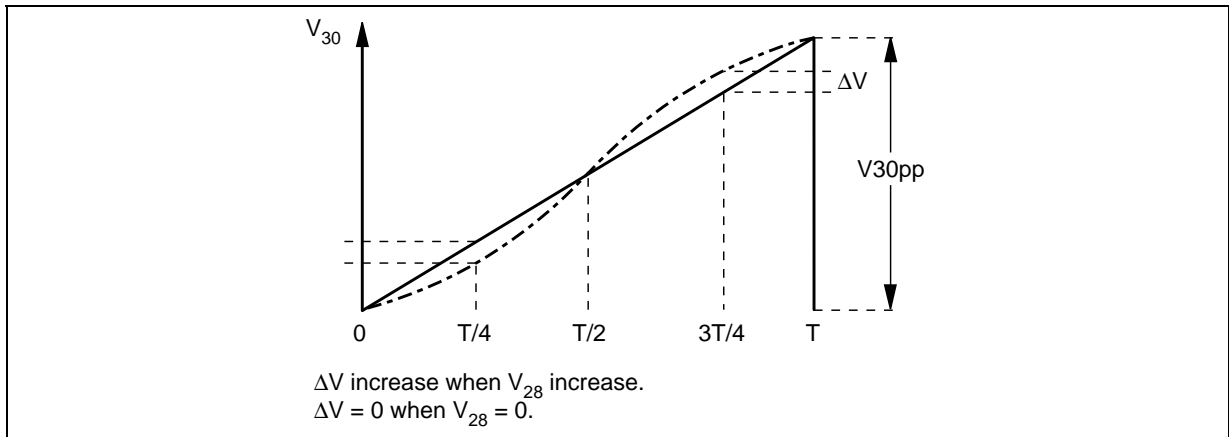
7778S-06.EPS

Figure 2 : Keystone Adjustment



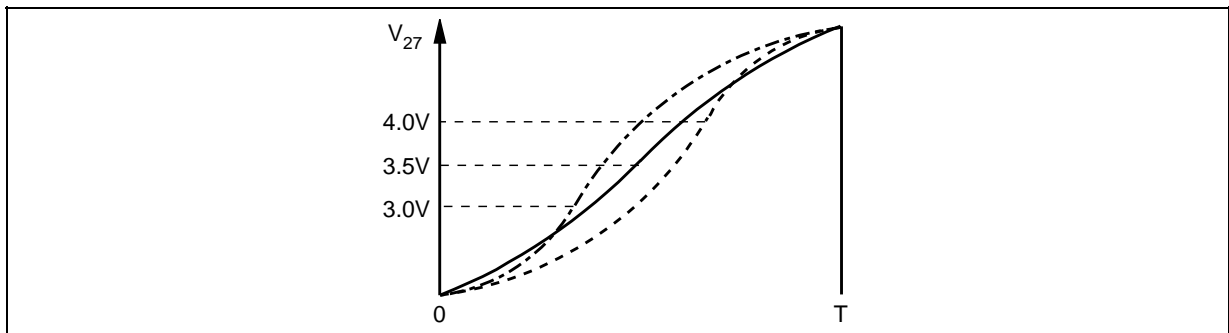
7778S-03.AI

Figure 3 : S Amplitude Adjustment

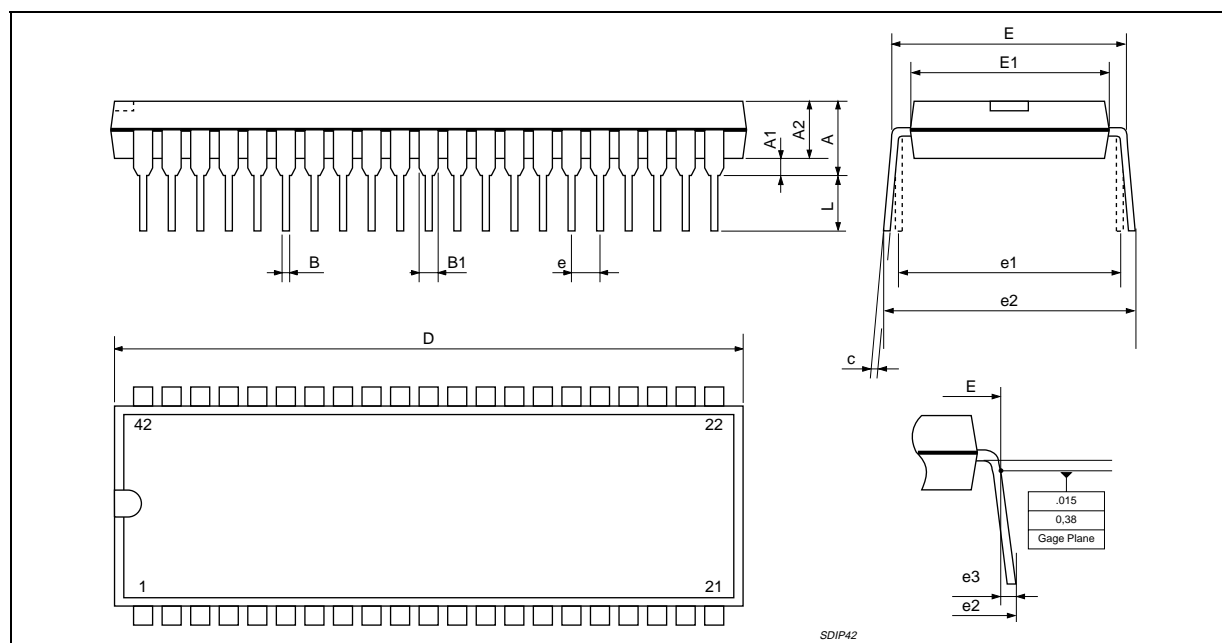


7778S-04.AI

Figure 4 : C Correction Adjustment



7778S-05.AI

**PACKAGE MECHANICAL DATA**  
 42 PINS - PLASTIC PACKAGE


PMSDIP42.EPS

Dimensions	Millimeters			Inches		
	Min.	Typ.	Max.	Min.	Typ.	Max.
A			5.08			0.200
A1	0.51			0.020		
A2	3.05	3.81	4.57	0.120	0.150	0.180
B	0.36	0.46	0.56	0.0142	0.0181	0.0220
B1	0.76	1.02	1.14	0.030	0.040	0.045
c	0.23	0.25	0.38	0.0090	0.0098	0.0150
D	37.85	38.10	38.35	1.490	1.5	1.510
E	15.24		16.00	0.60		0.629
E1	12.70	13.72	14.48	0.50	0.540	0.570
e		1.778			0.070	
e1		15.24			0.60	
e2			18.54			0.730
e3			1.52			0.060
L	2.54	3.30	3.56	0.10	0.130	0.140

SDIP42.TBL

Information furnished is believed to be accurate and reliable. However, STMicroelectronics assumes no responsibility for the consequences of use of such information nor for any infringement of patents or other rights of third parties which may result from its use. No licence is granted by implication or otherwise under any patent or patent rights of STMicroelectronics. Specifications mentioned in this publication are subject to change without notice. This publication supersedes and replaces all information previously supplied. STMicroelectronics products are not authorized for use as critical components in life support devices or systems without express written approval of STMicroelectronics.

The ST logo is a registered trademark of STMicroelectronics

© 1998 STMicroelectronics - All Rights Reserved

Purchase of I<sup>2</sup>C Components of STMicroelectronics, conveys a license under the Philips I<sup>2</sup>C Patent. Rights to use these components in a I<sup>2</sup>C system, is granted provided that the system conforms to the I<sup>2</sup>C Standard Specifications as defined by Philips.

STMicroelectronics GROUP OF COMPANIES

Australia - Brazil - Canada - China - France - Germany - Italy - Japan - Korea - Malaysia - Malta - Mexico - Morocco - The Netherlands  
 Singapore - Spain - Sweden - Switzerland - Taiwan - Thailand - United Kingdom - U.S.A.

<http://www.st.com>

