

N-channel 600 V, 0.14 Ω typ., 20 A MDmesh™ M2 Power MOSFETs in TO-220 and TO-247 packages

Datasheet - production data

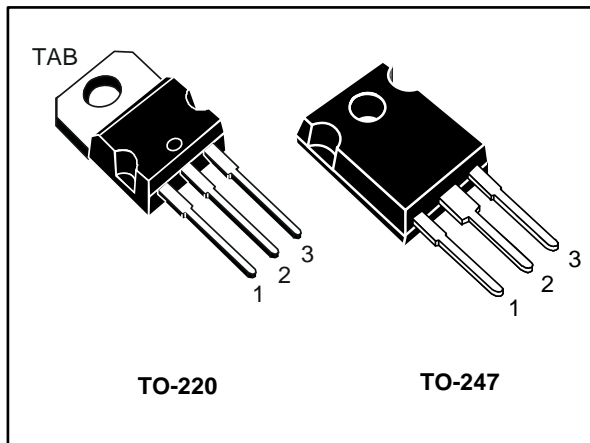

Figure 1: Internal schematic diagram

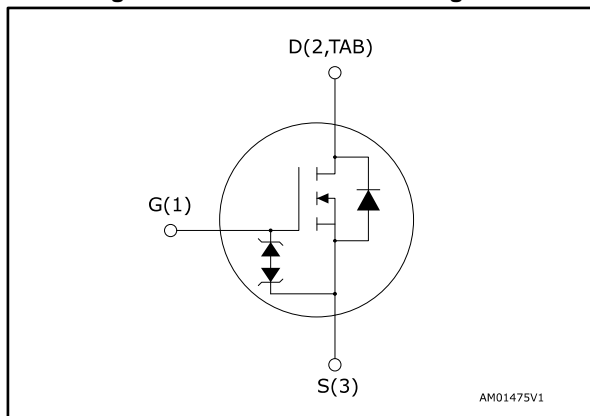

Table 1: Device summary

Order code	Marking	Package	Packing
STP26N60M2	26N60M2	TO-220	Tube
STW26N60M2		TO-247	

Features

Order code	V _{DS} @ T _{Jmax}	R _{DS(on)} max.	I _D	P _{TOT}
STP26N60M2	650 V	0.165 Ω	20 A	169 W
STW26N60M2				

- Extremely low gate charge
- Excellent output capacitance (C_{oss}) profile
- 100% avalanche tested
- Zener-protected

Applications

- Switching applications

Description

These devices are N-channel Power MOSFETs developed using MDmesh™ M2 technology. Thanks to their strip layout and improved vertical structure, these devices exhibit low on-resistance and optimized switching characteristics, rendering them suitable for the most demanding high efficiency converters.

Contents

1	Electrical ratings	3
2	Electrical characteristics	4
	2.1 Electrical characteristics (curves).....	6
3	Test circuits	9
4	Package information	10
	4.1 TO-220 type A package information.....	11
	4.2 TO-247 package information.....	13
5	Revision history	15

1 Electrical ratings

Table 2: Absolute maximum ratings

Symbol	Parameter	Value	Unit
V_{GS}	Gate-source voltage	± 25	V
I_D	Drain current (continuous) at $T_{case} = 25\text{ }^\circ\text{C}$	20	A
	Drain current (continuous) at $T_{case} = 100\text{ }^\circ\text{C}$	13	
$I_{DM}^{(1)}$	Drain current (pulsed)	80	A
P_{TOT}	Total dissipation at $T_{case} = 25\text{ }^\circ\text{C}$	169	W
$dv/dt^{(2)}$	Peak diode recovery voltage slope	15	V/ns
$dv/dt^{(3)}$	MOSFET dv/dt ruggedness	50	
T_{stg}	Storage temperature range	-55 to 150	$^\circ\text{C}$
T_j	Operating junction temperature range		

Notes:

- (1) Pulse width is limited by safe operating area.
 (2) $I_{SD} \leq 20\text{ A}$, $di/dt=400\text{ A}/\mu\text{s}$; $V_{DS(peak)} < V_{(BR)DSS}$, $V_{DD} = 80\% V_{(BR)DSS}$.
 (3) $V_{DS} \leq 480\text{ V}$.

Table 3: Thermal data

Symbol	Parameter	Value		Unit
		TO-220	TO-247	
$R_{thj-case}$	Thermal resistance junction-case	0.74		$^\circ\text{C}/\text{W}$
$R_{thj-amb}$	Thermal resistance junction-ambient	62.5	50	

Table 4: Avalanche characteristics

Symbol	Parameter	Value	Unit
$I_{AR}^{(1)}$	Avalanche current, repetitive or not repetitive	3.8	A
$E_{AS}^{(2)}$	Single pulse avalanche energy	250	mJ

Notes:

- (1) Pulse width limited by T_{jmax} .
 (2) starting $T_j = 25\text{ }^\circ\text{C}$, $I_D = I_{AR}$, $V_{DD} = 50\text{ V}$.

2 Electrical characteristics

($T_{\text{case}} = 25\text{ °C}$ unless otherwise specified)

Table 5: Static

Symbol	Parameter	Test conditions	Min.	Typ.	Max.	Unit
$V_{(\text{BR})\text{DSS}}$	Drain-source breakdown voltage	$V_{\text{GS}} = 0\text{ V}$, $I_{\text{D}} = 1\text{ mA}$	600			V
I_{DSS}	Zero gate voltage drain current	$V_{\text{GS}} = 0\text{ V}$, $V_{\text{DS}} = 600\text{ V}$			1	μA
		$V_{\text{GS}} = 0\text{ V}$, $V_{\text{DS}} = 600\text{ V}$, $T_{\text{case}} = 125\text{ °C}^{(1)}$			100	
I_{GSS}	Gate-body leakage current	$V_{\text{DS}} = 0\text{ V}$, $V_{\text{GS}} = \pm 25\text{ V}$			± 10	μA
$V_{\text{GS(th)}}$	Gate threshold voltage	$V_{\text{DS}} = V_{\text{GS}}$, $I_{\text{D}} = 250\text{ }\mu\text{A}$	2	3	4	V
$R_{\text{DS(on)}}$	Static drain-source on-resistance	$V_{\text{GS}} = 10\text{ V}$, $I_{\text{D}} = 10\text{ A}$		0.14	0.165	Ω

Notes:

⁽¹⁾ Defined by design, not subject to production test.

Table 6: Dynamic

Symbol	Parameter	Test conditions	Min.	Typ.	Max.	Unit
C_{ISS}	Input capacitance	$V_{\text{DS}} = 100\text{ V}$, $f = 1\text{ MHz}$, $V_{\text{GS}} = 0\text{ V}$	-	1360	-	pF
C_{OSS}	Output capacitance		-	88	-	
C_{RSS}	Reverse transfer capacitance		-	2	-	
$C_{\text{OSS eq.}}^{(1)}$	Equivalent output capacitance	$V_{\text{DS}} = 0\text{ to }480\text{ V}$, $V_{\text{GS}} = 0\text{ V}$	-	124	-	pF
R_{G}	Intrinsic gate resistance	$f = 1\text{ MHz}$, $I_{\text{D}} = 0\text{ A}$	-	4	-	Ω
Q_{g}	Total gate charge	$V_{\text{DD}} = 480\text{ V}$, $I_{\text{D}} = 20\text{ A}$, $V_{\text{GS}} = 10\text{ V}$ (see Figure 17: "Test circuit for gate charge behavior")	-	34	-	nC
Q_{gs}	Gate-source charge		-	5.6	-	
Q_{gd}	Gate-drain charge		-	16.3	-	

Notes:

⁽¹⁾ $C_{\text{OSS eq.}}$ is defined as a constant equivalent capacitance giving the same charging time as C_{OSS} when V_{DS} increases from 0 to 80% V_{DSS} .

Table 7: Switching times

Symbol	Parameter	Test conditions	Min.	Typ.	Max.	Unit
$t_{\text{d(on)}}$	Turn-on delay time	$V_{\text{DD}} = 300\text{ V}$, $I_{\text{D}} = 10\text{ A}$, $R_{\text{G}} = 4.7\text{ }\Omega$, $V_{\text{GS}} = 10\text{ V}$ (see Figure 16: "Test circuit for resistive load switching times" and Figure 21: "Switching time waveform")	-	20.2	-	ns
t_{r}	Rise time		-	8	-	
$t_{\text{d(off)}}$	Turn-off delay time		-	66	-	
t_{f}	Fall time		-	10	-	

Table 8: Source-drain diode

Symbol	Parameter	Test conditions	Min.	Typ.	Max.	Unit
I_{SD}	Source-drain current		-		20	A
$I_{SDM}^{(1)}$	Source-drain current (pulsed)		-		80	A
$V_{SD}^{(2)}$	Forward on voltage	$V_{GS} = 0 \text{ V}$, $I_{SD} = 20 \text{ A}$	-		1.6	V
t_{rr}	Reverse recovery time	$I_{SD} = 20 \text{ A}$, $di/dt = 100 \text{ A}/\mu\text{s}$, $V_{DD} = 60 \text{ V}$ (see Figure 18 : "Test circuit for inductive load switching and diode recovery times")	-	360		ns
Q_{rr}	Reverse recovery charge		-	5		μC
I_{RRM}	Reverse recovery current		-	27		A
t_{rr}	Reverse recovery time	$I_{SD} = 20 \text{ A}$, $di/dt = 100 \text{ A}/\mu\text{s}$, $V_{DD} = 60 \text{ V}$, $T_j = 150 \text{ }^\circ\text{C}$ (see Figure 18 : "Test circuit for inductive load switching and diode recovery times")	-	556		ns
Q_{rr}	Reverse recovery charge		-	8		μC
I_{RRM}	Reverse recovery current		-	29		A

Notes:

- (1) Pulse width is limited by safe operating area.
(2) Pulse test: pulse duration = 300 μs , duty cycle 1.5%.

2.1 Electrical characteristics (curves)

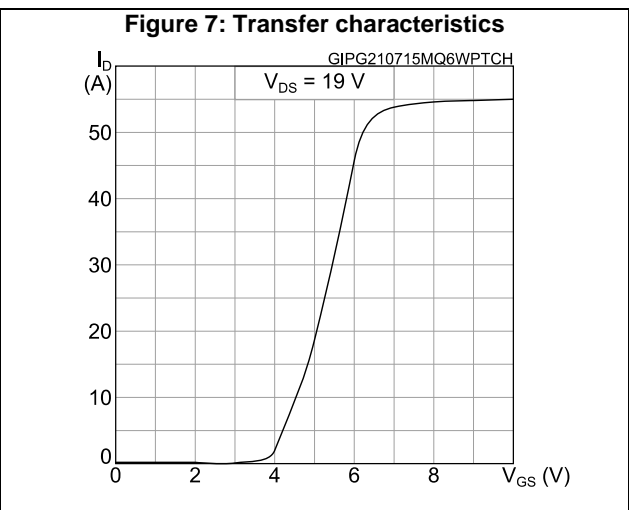
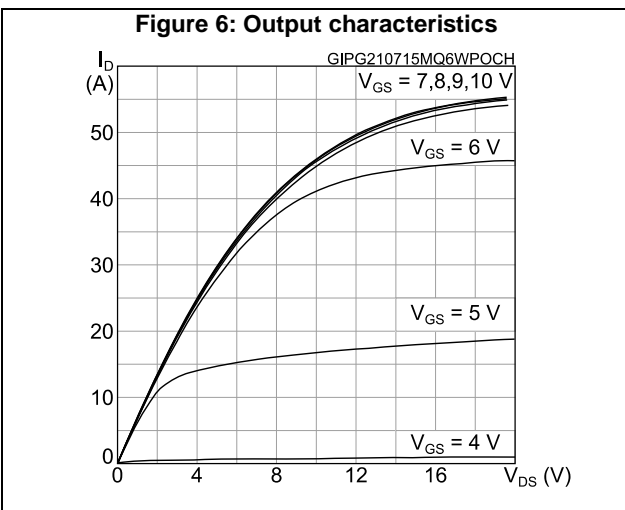
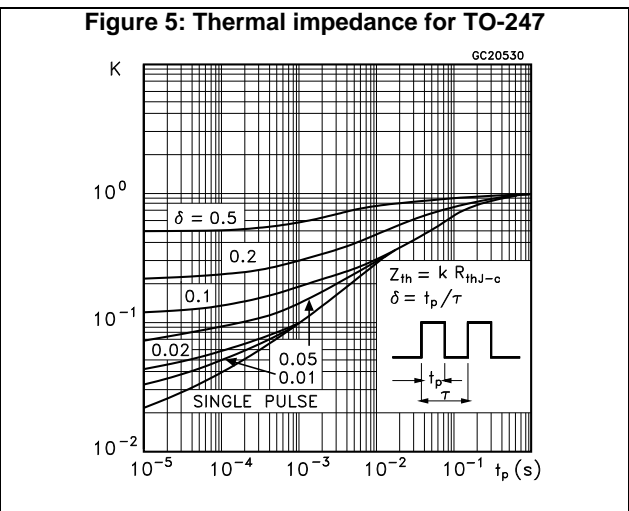
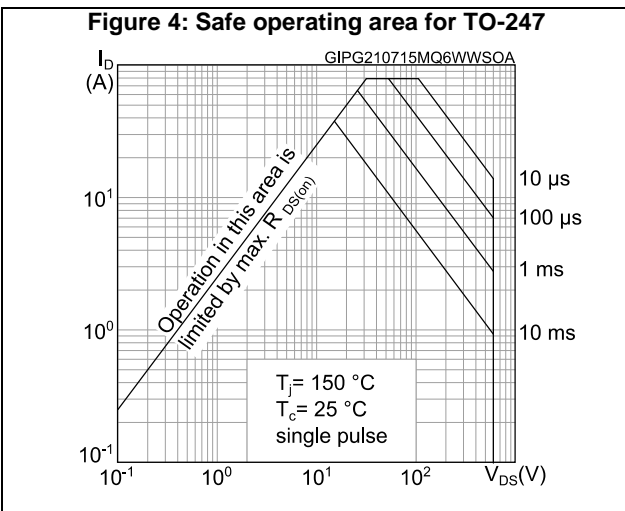
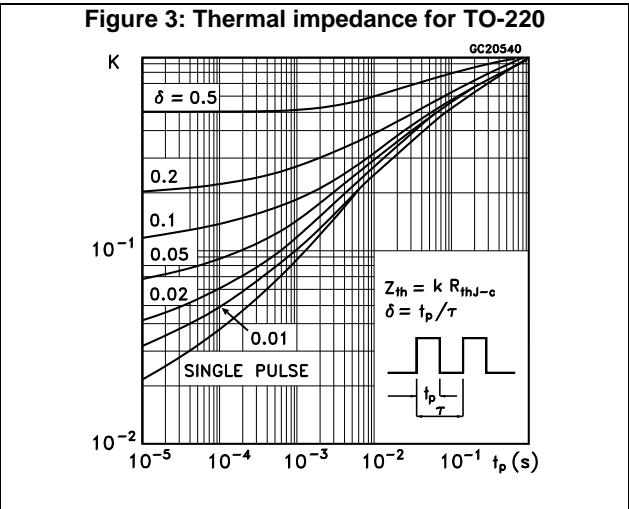
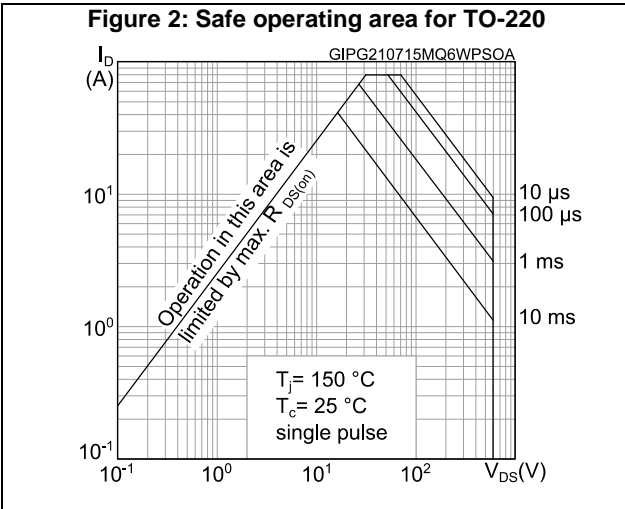

Figure 8: Gate charge vs gate-source voltage

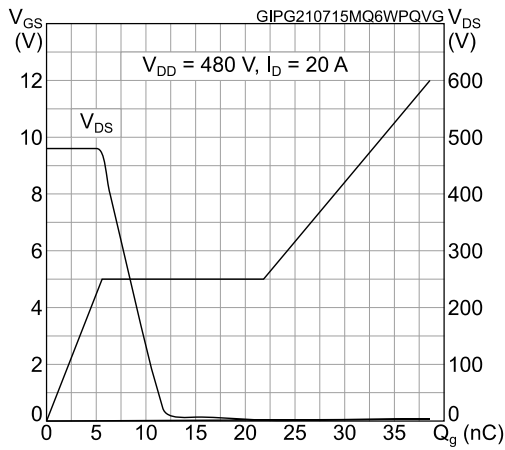

Figure 9: Static drain-source on-resistance

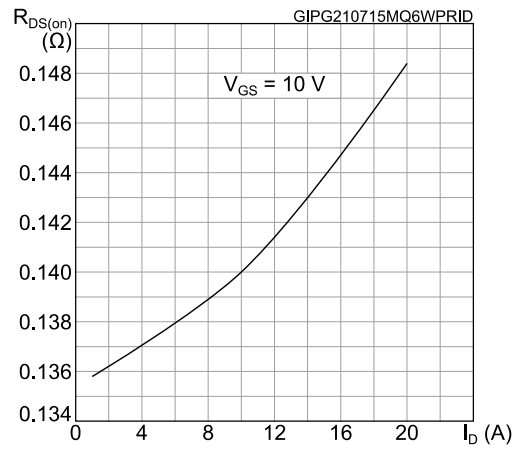

Figure 10: Capacitance variations

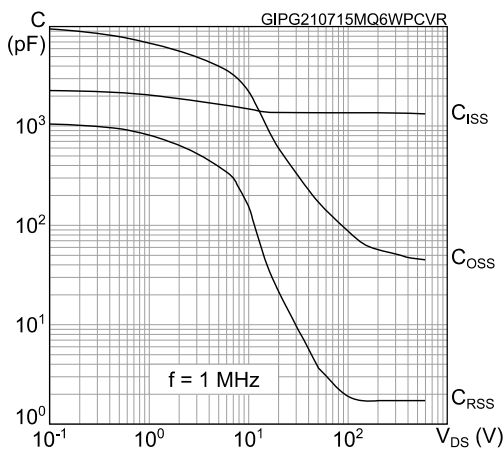

Figure 11: Normalized gate threshold voltage vs temperature

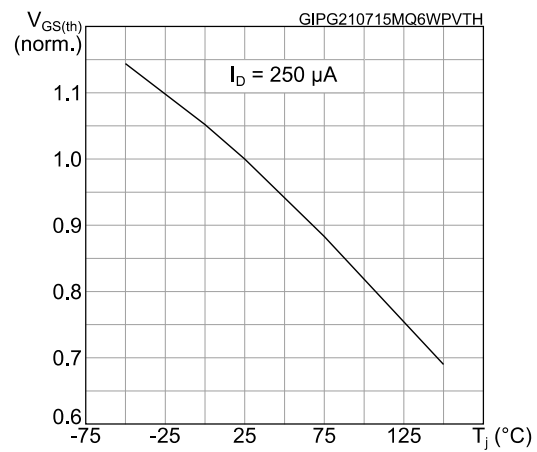

Figure 12: Normalized on-resistance vs temperature

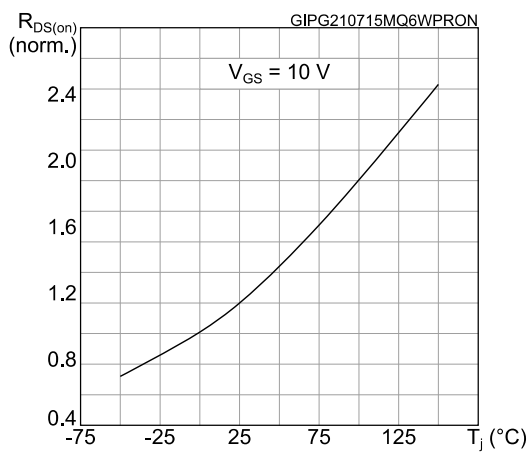

Figure 13: Normalized V(BR)DSS vs temperature

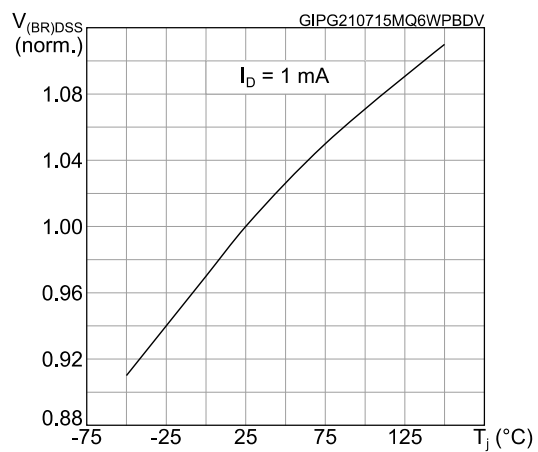

Figure 14: Output capacitance stored energy

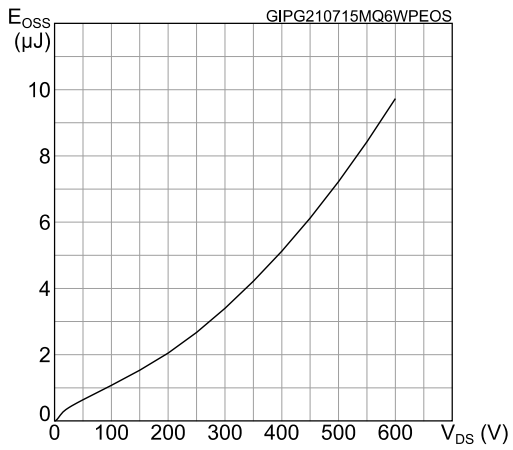
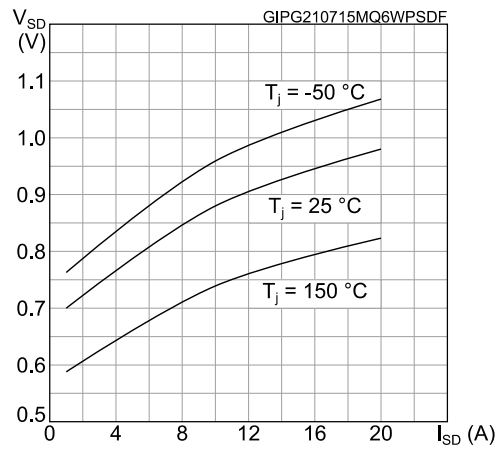

Figure 15: Source-drain diode forward characteristics



3 Test circuits

Figure 16: Test circuit for resistive load switching times



AM01468v1

Figure 17: Test circuit for gate charge behavior



AM01469v1

Figure 18: Test circuit for inductive load switching and diode recovery times

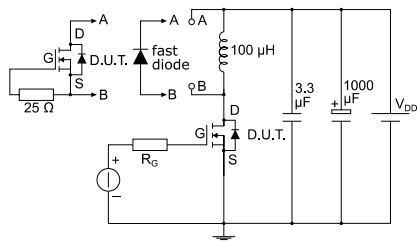

AM01470v1

Figure 19: Unclamped inductive load test circuit

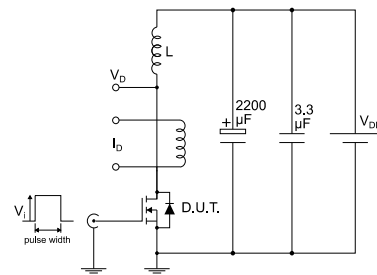

AM01471v1

Figure 20: Unclamped inductive waveform

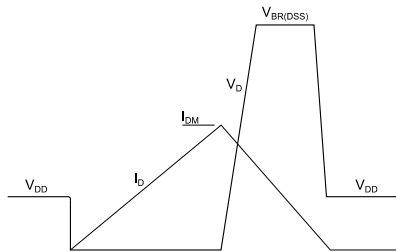

AM01472v1

Figure 21: Switching time waveform

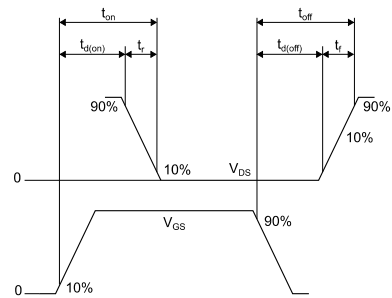

AM01473v1

4 Package information

In order to meet environmental requirements, ST offers these devices in different grades of ECOPACK® packages, depending on their level of environmental compliance. ECOPACK® specifications, grade definitions and product status are available at: www.st.com. ECOPACK® is an ST trademark.

4.1 TO-220 type A package information

Figure 22: TO-220 type A package outline

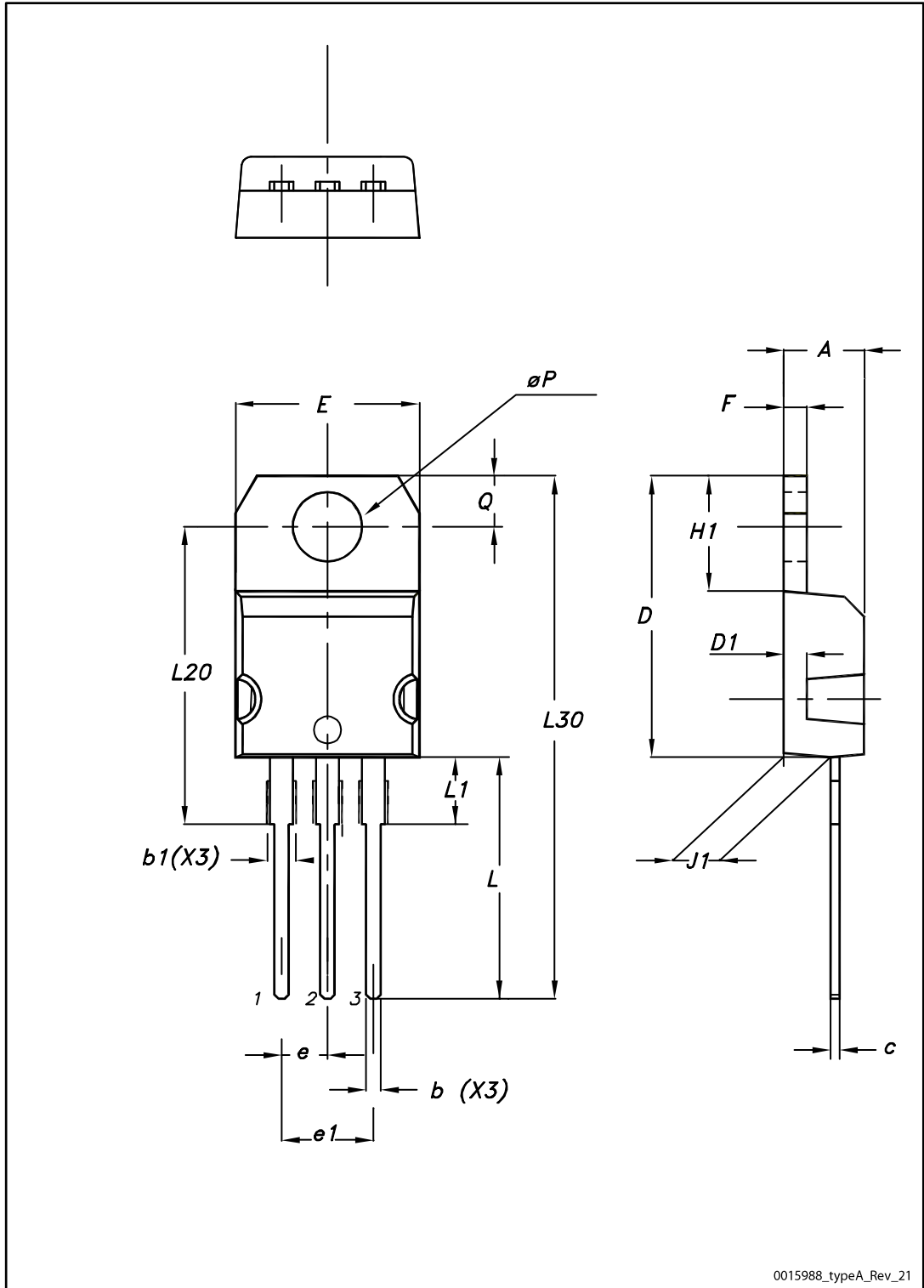

0015988_typeA_Rev_21

Table 9: TO-220 type A mechanical data

Dim.	mm		
	Min.	Typ.	Max.
A	4.40		4.60
b	0.61		0.88
b1	1.14		1.55
c	0.48		0.70
D	15.25		15.75
D1		1.27	
E	10.00		10.40
e	2.40		2.70
e1	4.95		5.15
F	1.23		1.32
H1	6.20		6.60
J1	2.40		2.72
L	13.00		14.00
L1	3.50		3.93
L20		16.40	
L30		28.90	
øP	3.75		3.85
Q	2.65		2.95

4.2 TO-247 package information

Figure 23: TO-247 package outline

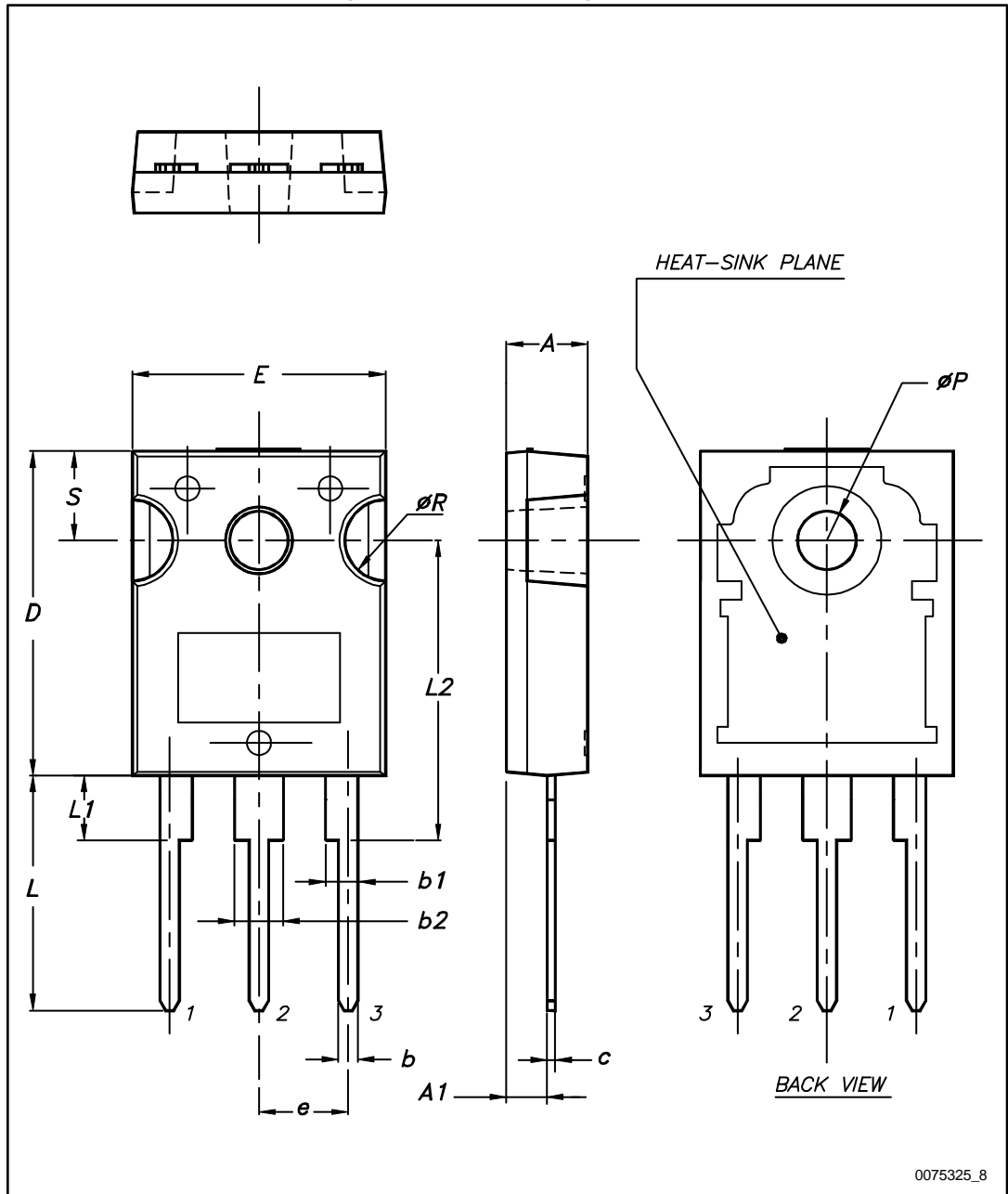

Table 10: TO-247 package mechanical data

Dim.	mm		
	Min.	Typ.	Max.
A	4.85		5.15
A1	2.20		2.60
b	1.0		1.40
b1	2.0		2.40
b2	3.0		3.40
c	0.40		0.80
D	19.85		20.15
E	15.45		15.75
e	5.30	5.45	5.60
L	14.20		14.80
L1	3.70		4.30
L2		18.50	
ØP	3.55		3.65
ØR	4.50		5.50
S	5.30	5.50	5.70

5 Revision history

Table 11: Document revision history

Date	Revision	Changes
03-Aug-2015	1	First release.
08-Mar-2017	2	Updated <i>Table 2: "Absolute maximum ratings"</i> , <i>Table 3: "Thermal data"</i> and <i>Figure 10: "Capacitance variations"</i> . Minor text changes.

IMPORTANT NOTICE – PLEASE READ CAREFULLY

STMicroelectronics NV and its subsidiaries ("ST") reserve the right to make changes, corrections, enhancements, modifications, and improvements to ST products and/or to this document at any time without notice. Purchasers should obtain the latest relevant information on ST products before placing orders. ST products are sold pursuant to ST's terms and conditions of sale in place at the time of order acknowledgement.

Purchasers are solely responsible for the choice, selection, and use of ST products and ST assumes no liability for application assistance or the design of Purchasers' products.

No license, express or implied, to any intellectual property right is granted by ST herein.

Resale of ST products with provisions different from the information set forth herein shall void any warranty granted by ST for such product.

ST and the ST logo are trademarks of ST. All other product or service names are the property of their respective owners.

Information in this document supersedes and replaces information previously supplied in any prior versions of this document.

© 2017 STMicroelectronics – All rights reserved