

## Automotive-grade N-channel 600 V, 0.037 $\Omega$ typ., 66 A MDmesh™ DM2 Power MOSFET in a TO-247 package

Datasheet - production data

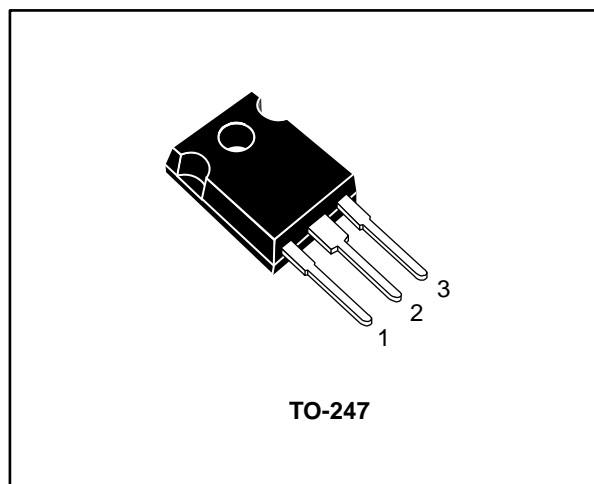
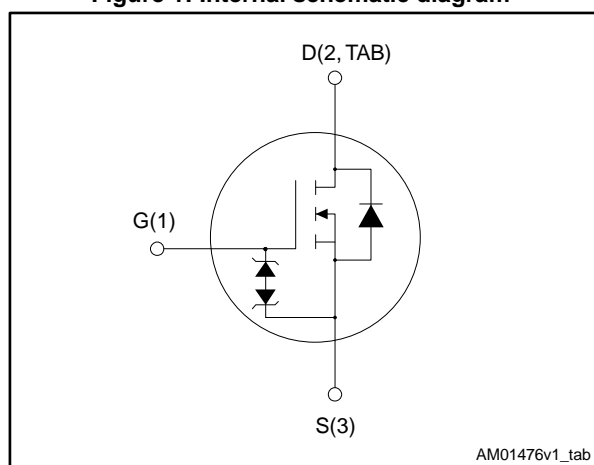

Figure 1: Internal schematic diagram



### Features

Order code	V <sub>DS</sub>	R <sub>DS(on)</sub> max.	I <sub>D</sub>	P <sub>TOT</sub>
STW72N60DM2AG	600 V	0.042 $\Omega$	66 A	446 W



- AEC-Q101 qualified
- Fast-recovery body diode
- Extremely low gate charge and input capacitance
- Low on-resistance
- 100% avalanche tested
- Extremely high dv/dt ruggedness
- Zener-protected

### Applications

- Switching applications

### Description

This high voltage N-channel Power MOSFET is part of the MDmesh™ DM2 fast recovery diode series. It offers very low recovery charge ( $Q_{rr}$ ) and time ( $t_{rr}$ ) combined with low  $R_{DS(on)}$ , rendering it suitable for the most demanding high efficiency converters and ideal for bridge topologies and ZVS phase-shift converters.

Table 1: Device summary

Order code	Marking	Package	Packing
STW72N60DM2AG	72N60DM2	TO-247	Tube

---

**Contents**

<b>1</b>	<b>Electrical ratings .....</b>	<b>3</b>
<b>2</b>	<b>Electrical characteristics .....</b>	<b>4</b>
	2.1 Electrical characteristics (curves).....	6
<b>3</b>	<b>Test circuits .....</b>	<b>8</b>
<b>4</b>	<b>Package information .....</b>	<b>9</b>
	4.1 TO-247 package information.....	9
<b>5</b>	<b>Revision history .....</b>	<b>11</b>

# 1 Electrical ratings

**Table 2: Absolute maximum ratings**

Symbol	Parameter	Value	Unit
$V_{GS}$	Gate-source voltage	$\pm 25$	V
$I_D$	Drain current (continuous) at $T_{case} = 25\text{ }^\circ\text{C}$	66	A
	Drain current (continuous) at $T_{case} = 100\text{ }^\circ\text{C}$	42	
$I_{DM}^{(1)}$	Drain current (pulsed)	264	A
$P_{TOT}$	Total dissipation at $T_{case} = 25\text{ }^\circ\text{C}$	446	W
$dv/dt^{(2)}$	Peak diode recovery voltage slope	50	V/ns
$dv/dt^{(3)}$	MOSFET $dv/dt$ ruggedness	50	
$T_{stg}$	Storage temperature range	-55 to 150	$^\circ\text{C}$
$T_j$	Junction temperature range		

**Notes:**

(1) Pulse width is limited by safe operating area.

(2)  $I_{SD} \leq 66\text{ A}$ ,  $di/dt=800\text{ A}/\mu\text{s}$ ;  $V_{DS\text{ peak}} < V_{(BR)DSS}$ ,  $V_{DD} = 80\% V_{(BR)DSS}$ .

(3)  $V_{DS} \leq 480\text{ V}$ .

**Table 3: Thermal data**

Symbol	Parameter	Value	Unit
$R_{thj-case}$	Thermal resistance junction-case	0.28	$^\circ\text{C}/\text{W}$
$R_{thj-amb}$	Thermal resistance junction-ambient	50	

**Table 4: Avalanche characteristics**

Symbol	Parameter	Value	Unit
$I_{AR}$	Avalanche current, repetitive or not repetitive (pulse width limited by $T_{jmax}$ )	10	A
$E_{AS}$	Single pulse avalanche energy (starting $T_j = 25\text{ }^\circ\text{C}$ , $I_D = I_{AR}$ , $V_{DD} = 50\text{ V}$ )	1500	mJ

## 2 Electrical characteristics

( $T_{\text{case}} = 25\text{ °C}$  unless otherwise specified)

**Table 5: Static**

Symbol	Parameter	Test conditions	Min.	Typ.	Max.	Unit
$V_{(\text{BR})\text{DSS}}$	Drain-source breakdown voltage	$V_{\text{GS}} = 0\text{ V}$ , $I_{\text{D}} = 1\text{ mA}$	600			V
$I_{\text{DSS}}$	Zero gate voltage drain current	$V_{\text{GS}} = 0\text{ V}$ , $V_{\text{DS}} = 600\text{ V}$			10	$\mu\text{A}$
		$V_{\text{GS}} = 0\text{ V}$ , $V_{\text{DS}} = 600\text{ V}$ , $T_{\text{case}} = 125\text{ °C}^{(1)}$			100	
$I_{\text{GSS}}$	Gate-body leakage current	$V_{\text{DS}} = 0\text{ V}$ , $V_{\text{GS}} = \pm 25\text{ V}$			$\pm 5$	$\mu\text{A}$
$V_{\text{GS(th)}}$	Gate threshold voltage	$V_{\text{DS}} = V_{\text{GS}}$ , $I_{\text{D}} = 250\text{ }\mu\text{A}$	3	4	5	V
$R_{\text{DS(on)}}$	Static drain-source on-resistance	$V_{\text{GS}} = 10\text{ V}$ , $I_{\text{D}} = 33\text{ A}$		0.037	0.042	$\Omega$

**Notes:**

<sup>(1)</sup> Defined by design, not subject to production test.

**Table 6: Dynamic**

Symbol	Parameter	Test conditions	Min.	Typ.	Max.	Unit
$C_{\text{iss}}$	Input capacitance	$V_{\text{DS}} = 100\text{ V}$ , $f = 1\text{ MHz}$ , $V_{\text{GS}} = 0\text{ V}$	-	5508	-	$\text{pF}$
$C_{\text{oss}}$	Output capacitance		-	241	-	
$C_{\text{rss}}$	Reverse transfer capacitance		-	2.8	-	
$C_{\text{oss eq.}}^{(1)}$	Equivalent output capacitance	$V_{\text{DS}} = 0\text{ to }480\text{ V}$ , $V_{\text{GS}} = 0\text{ V}$	-	470	-	$\text{pF}$
$R_{\text{G}}$	Intrinsic gate resistance	$f = 1\text{ MHz}$ open drain	-	2	-	$\Omega$
$Q_{\text{g}}$	Total gate charge	$V_{\text{DD}} = 480\text{ V}$ , $I_{\text{D}} = 66\text{ A}$ , $V_{\text{GS}} = 10\text{ V}$ (see <a href="#">Figure 15: "Test circuit for gate charge behavior"</a> )	-	121	-	$\text{nC}$
$Q_{\text{gs}}$	Gate-source charge		-	26	-	
$Q_{\text{gd}}$	Gate-drain charge		-	61	-	

**Notes:**

<sup>(1)</sup>  $C_{\text{oss eq.}}$  is defined as a constant equivalent capacitance giving the same charging time as  $C_{\text{oss}}$  when  $V_{\text{DS}}$  increases from 0 to 80%  $V_{\text{DSS}}$ .

**Table 7: Switching times**

Symbol	Parameter	Test conditions	Min.	Typ.	Max.	Unit
$t_{\text{d(on)}}$	Turn-on delay time	$V_{\text{DD}} = 300\text{ V}$ , $I_{\text{D}} = 33\text{ A}$ $R_{\text{G}} = 4.7\text{ }\Omega$ , $V_{\text{GS}} = 10\text{ V}$ (see <a href="#">Figure 14: "Test circuit for resistive load switching times"</a> and <a href="#">Figure 19: "Switching time waveform"</a> )	-	32	-	$\text{ns}$
$t_{\text{r}}$	Rise time		-	67	-	
$t_{\text{d(off)}}$	Turn-off delay time		-	112	-	
$t_{\text{f}}$	Fall time		-	10.4	-	

Table 8: Source-drain diode

Symbol	Parameter	Test conditions	Min.	Typ.	Max.	Unit
$I_{SD}$	Source-drain current		-		66	A
$I_{SDM}^{(1)}$	Source-drain current (pulsed)		-		264	A
$V_{SD}^{(2)}$	Forward on voltage	$V_{GS} = 0\text{ V}$ , $I_{SD} = 66\text{ A}$	-		1.6	V
$t_{rr}$	Reverse recovery time	$I_{SD} = 66\text{ A}$ , $di/dt = 100\text{ A}/\mu\text{s}$ , $V_{DD} = 480\text{ V}$ (see <a href="#">Figure 16</a> : "Test circuit for inductive load switching and diode recovery times")	-	150		ns
$Q_{rr}$	Reverse recovery charge		-	0.75		$\mu\text{C}$
$I_{RRM}$	Reverse recovery current		-	10.5		A
$t_{rr}$	Reverse recovery time	$I_{SD} = 66\text{ A}$ , $di/dt = 100\text{ A}/\mu\text{s}$ , $V_{DD} = 480\text{ V}$ , $T_j = 150\text{ }^\circ\text{C}$ (see <a href="#">Figure 16</a> : "Test circuit for inductive load switching and diode recovery times")	-	250		ns
$Q_{rr}$	Reverse recovery charge		-	2.5		$\mu\text{C}$
$I_{RRM}$	Reverse recovery current		-	20.7		A

**Notes:**

- (1) Pulse width is limited by safe operating area.  
(2) Pulse test: pulse duration = 300  $\mu\text{s}$ , duty cycle 1.5%.

## 2.1 Electrical characteristics (curves)

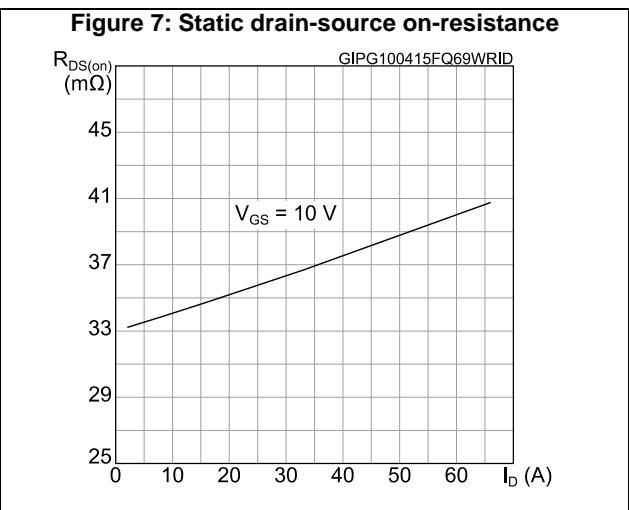
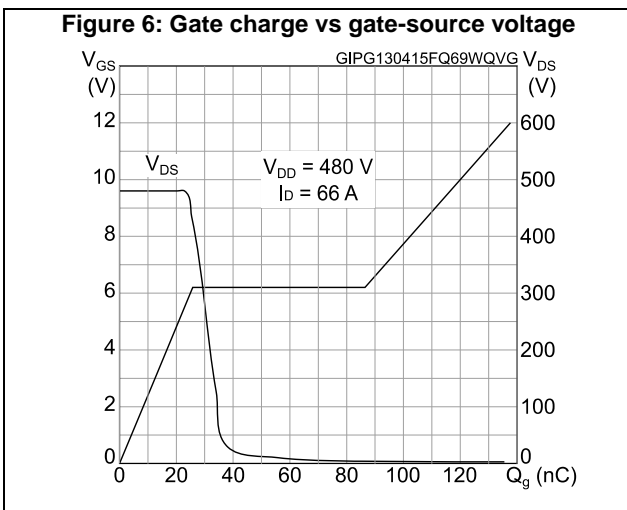
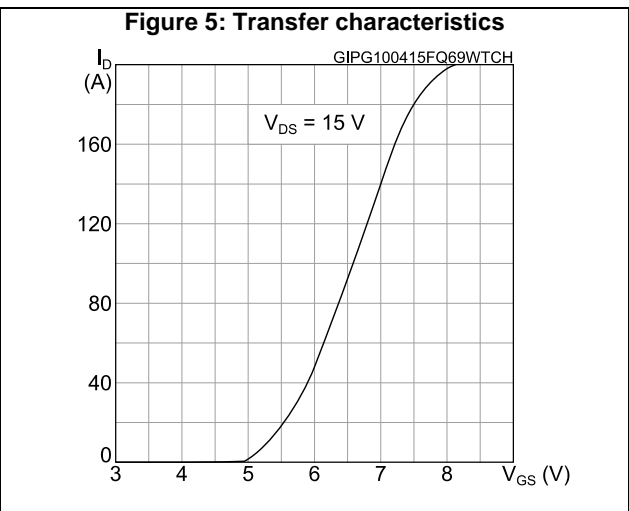
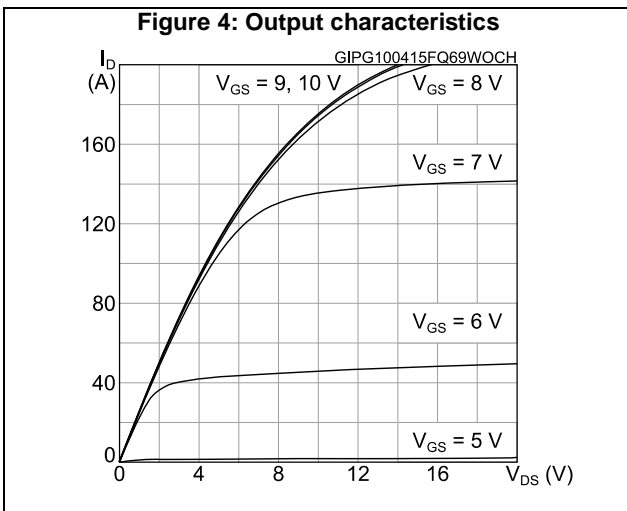
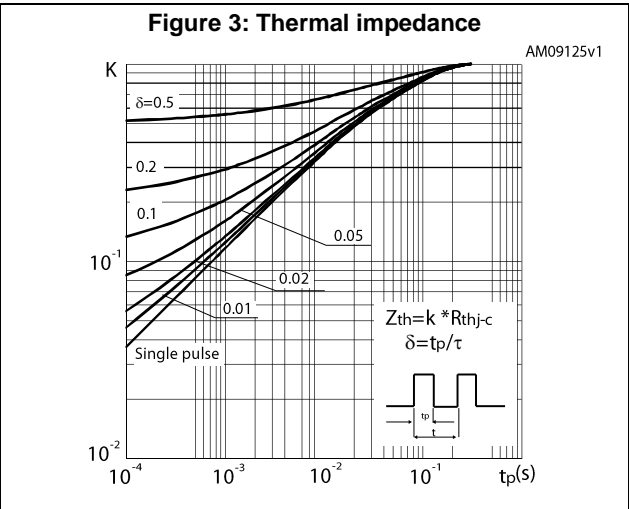
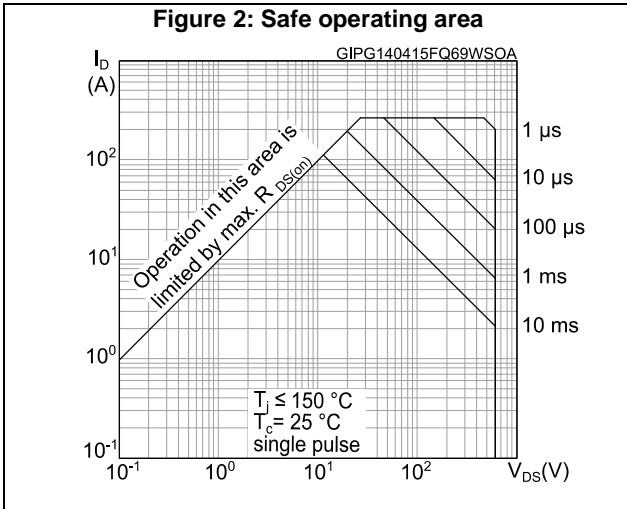

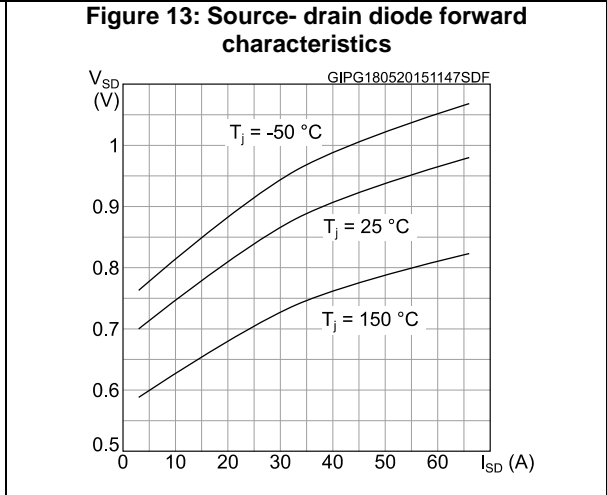
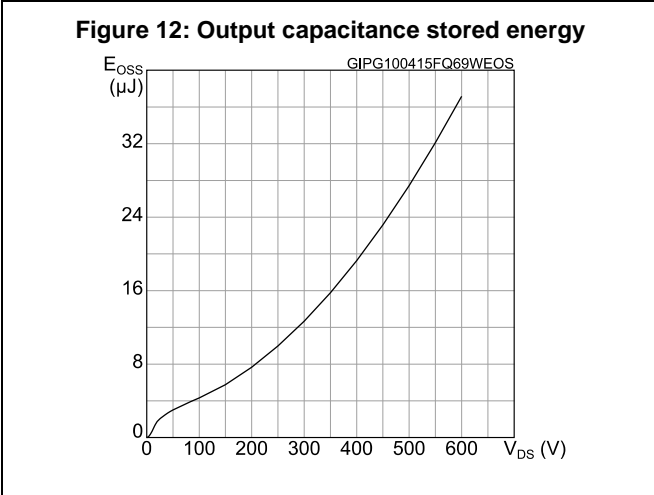
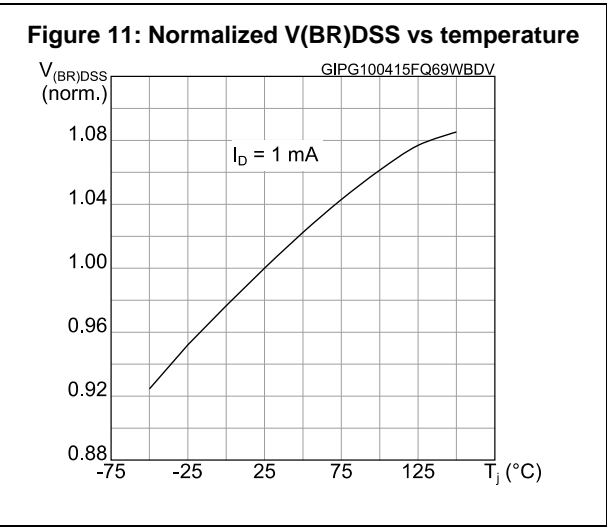
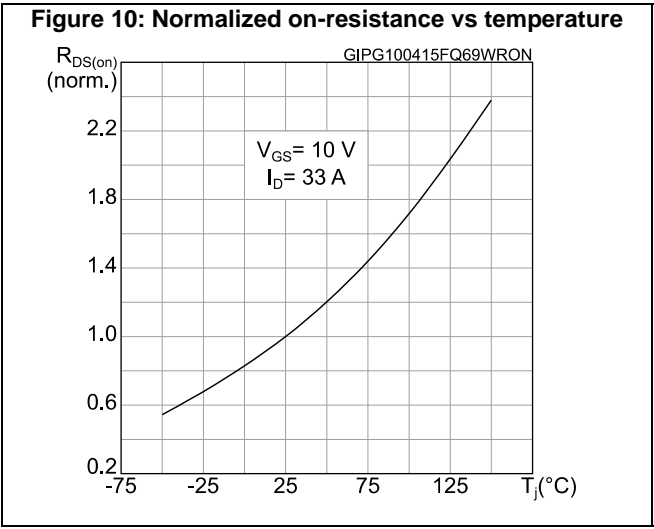
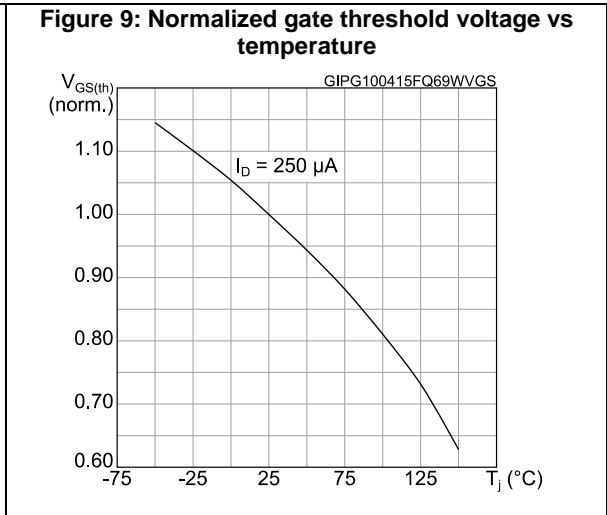
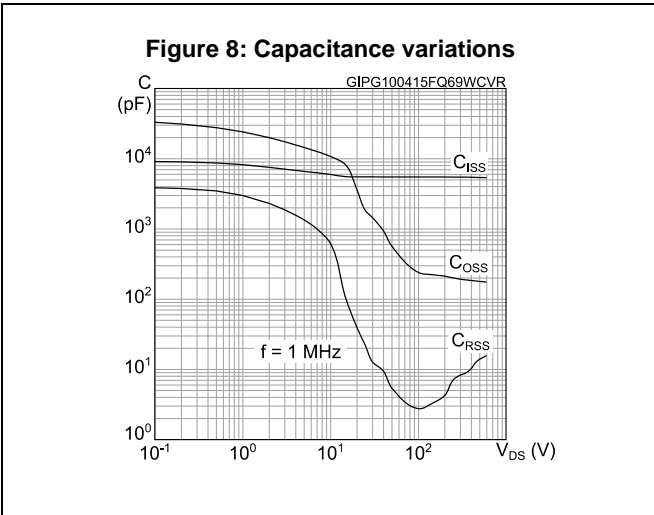

### 3 Test circuits

**Figure 14: Test circuit for resistive load switching times**



AM01468v1

**Figure 15: Test circuit for gate charge behavior**



AM01469v1

**Figure 16: Test circuit for inductive load switching and diode recovery times**



AM01470v1

**Figure 17: Unclamped inductive load test circuit**

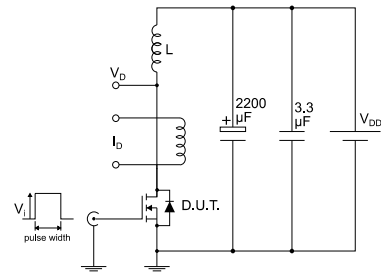

AM01471v1

**Figure 18: Unclamped inductive waveform**

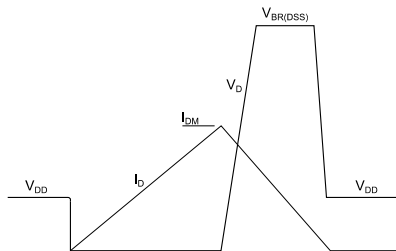

AM01472v1

**Figure 19: Switching time waveform**

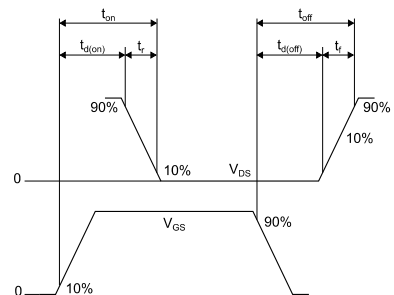

AM01473v1



## 4 Package information

In order to meet environmental requirements, ST offers these devices in different grades of ECOPACK® packages, depending on their level of environmental compliance. ECOPACK® specifications, grade definitions and product status are available at: [www.st.com](http://www.st.com). ECOPACK® is an ST trademark.

### 4.1 TO-247 package information

Figure 20: TO-247 package outline

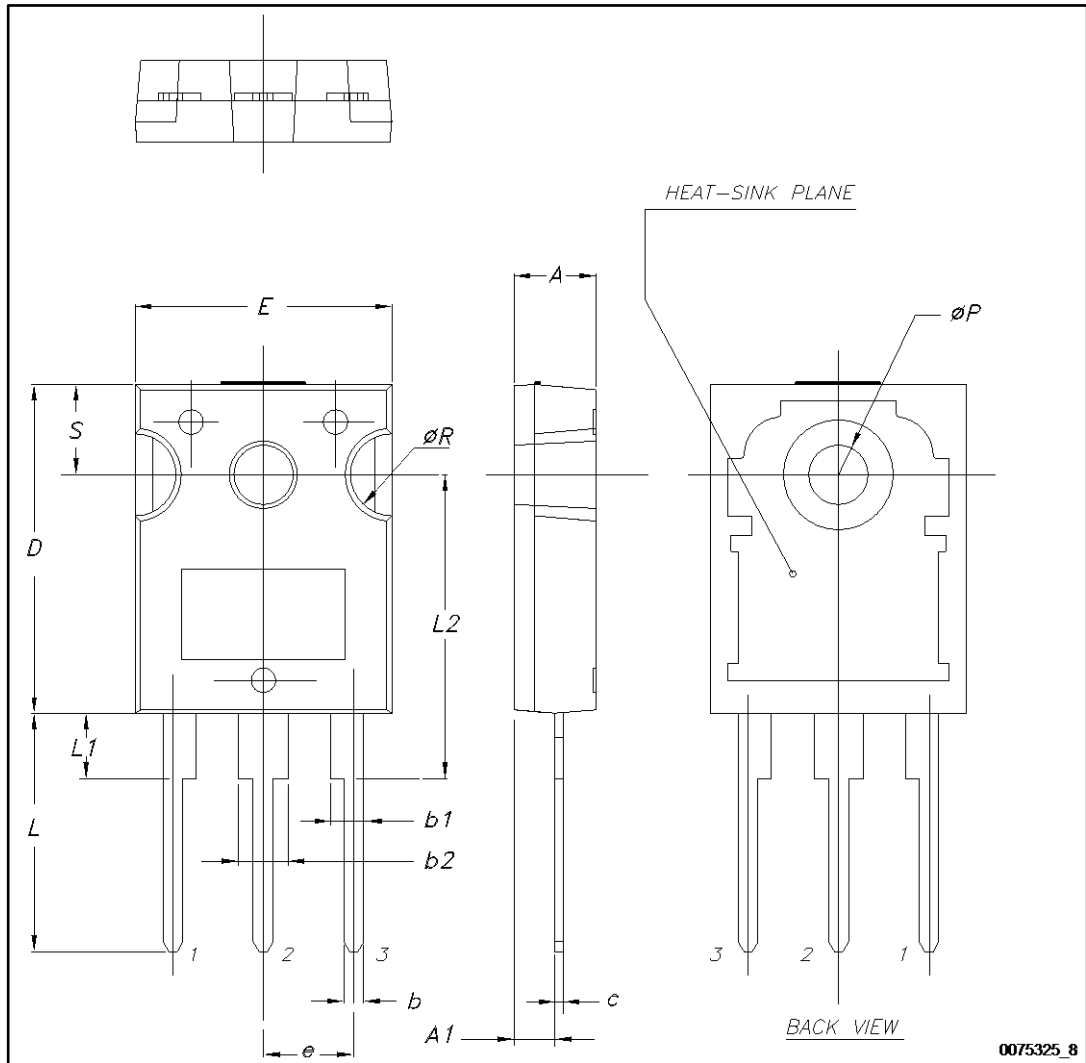

Table 9: TO-247 package mechanical data

Dim.	mm		
	Min.	Typ.	Max.
A	4.85		5.15
A1	2.20		2.60
b	1.0		1.40
b1	2.0		2.40
b2	3.0		3.40
c	0.40		0.80
D	19.85		20.15
E	15.45		15.75
e	5.30	5.45	5.60
L	14.20		14.80
L1	3.70		4.30
L2		18.50	
ØP	3.55		3.65
ØR	4.50		5.50
S	5.30	5.50	5.70

## 5 Revision history

**Table 10: Document revision history**

Date	Revision	Changes
27-Jan-2015	1	First release.
14-Apr-2015	2	Text edits and formatting changes throughout document Removed TO-247 long leads package data Added Section 2.1 Electrical characteristics (curves)
01-Jul-2015	3	Text edits and formatting changes throughout document On cover page: - updated title and features In Section Electrical ratings: - updated Table Absolute maximum ratings In Section Electrical characteristics: - updated Tables Static, Dynamic, Switching times and Source-drain diode Updated Section Electrical characteristics (curves)
09-Dec-2015	4	Updated Table 4: "Avalanche characteristics".
24-Oct-2016	5	Updated title and features in cover page. Minor text changes.

**IMPORTANT NOTICE – PLEASE READ CAREFULLY**

STMicroelectronics NV and its subsidiaries ("ST") reserve the right to make changes, corrections, enhancements, modifications, and improvements to ST products and/or to this document at any time without notice. Purchasers should obtain the latest relevant information on ST products before placing orders. ST products are sold pursuant to ST's terms and conditions of sale in place at the time of order acknowledgement.

Purchasers are solely responsible for the choice, selection, and use of ST products and ST assumes no liability for application assistance or the design of Purchasers' products.

No license, express or implied, to any intellectual property right is granted by ST herein.

Resale of ST products with provisions different from the information set forth herein shall void any warranty granted by ST for such product.

ST and the ST logo are trademarks of ST. All other product or service names are the property of their respective owners.

Information in this document supersedes and replaces information previously supplied in any prior versions of this document.

© 2016 STMicroelectronics – All rights reserved