

261-166

**N - CHANNEL ENHANCEMENT MODE
POWER MOS TRANSISTORS**

TYPE	V _{DSS}	R _{DS(on)}	I _D
STH8N80	800 V	< 1.2 Ω	8.2 A
STH8N80FI	800 V	< 1.2 Ω	5.1 A
STW8N80	800 V	< 1.2 Ω	8.2 A

- TYPICAL R_{DS(on)} = 0.98 Ω
- AVALANCHE RUGGED TECHNOLOGY
- 100% AVALANCHE TESTED
- REPETITIVE AVALANCHE DATA AT 100°C
- LOW INPUT CAPACITANCE
- LOW GATE CHARGE
- APPLICATION ORIENTED CHARACTERIZATION

APPLICATIONS

- HIGH CURRENT, HIGH SPEED SWITCHING
- SWITCH MODE POWER SUPPLIES (SMPS)
- CONSUMER AND INDUSTRIAL LIGHTING
- DC-AC INVERTERS FOR WELDING EQUIPMENT AND UNINTERRUPTIBLE POWER SUPPLY (UPS)

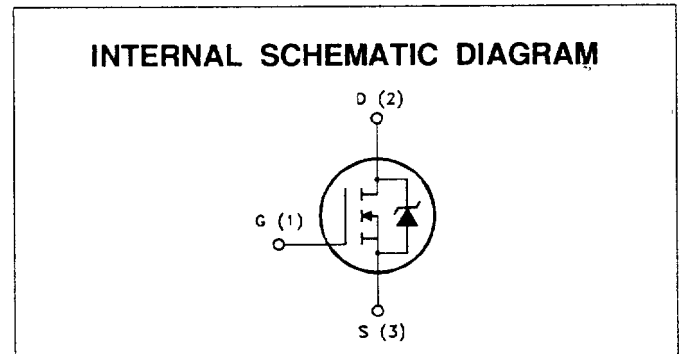
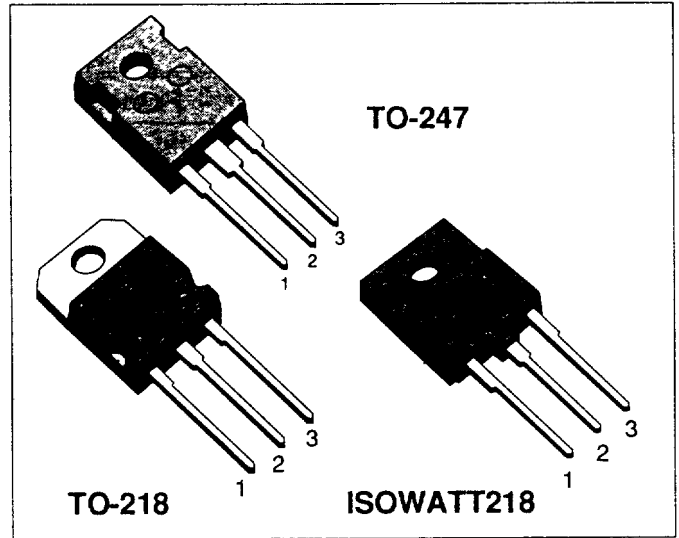

ABSOLUTE MAXIMUM RATINGS

Symbol	Parameter	Value		Unit
		STH/STW8N80	STH8N80FI	
V _{DS}	Drain-source Voltage (V _{GS} = 0)	800		V
V _{DGR}	Drain- gate Voltage (R _{GS} = 20 kΩ)	800		V
V _{GS}	Gate-source Voltage	± 20		V
I _D	Drain Current (continuous) at T _c = 25 °C	8.2	5.1	A
I _D	Drain Current (continuous) at T _c = 100 °C	5.1	3.2	A
I _{DM} (*)	Drain Current (pulsed)	35	35	A
P _{tot}	Total Dissipation at T _c = 25 °C	180	70	W
	Derating Factor	1.44	0.56	W/°C
V _{ISO}	Insulation Withstand Voltage (DC)	—	4000	V
T _{stg}	Storage Temperature	-65 to 150		°C
T _J	Max. Operating Junction Temperature	150		°C

(*) Pulse width limited by safe operating area

THERMAL DATA

			TO-218/TO-247	ISOWATT218	
R _{thj-case}	Thermal Resistance Junction-case	Max	0.69	1.78	°C/W
R _{thj-amb}	Thermal Resistance Junction-ambient	Max	30		°C/W
R _{thc-sink}	Thermal Resistance Case-sink	Typ	0.1		°C/W
T _l	Maximum Lead Temperature For Soldering Purpose		300		°C

AVALANCHE CHARACTERISTICS

Symbol	Parameter	Max Value	Unit
I _{AR}	Avalanche Current, Repetitive or Not-Repetitive (pulse width limited by T _j max, δ < 1%)	8.2	A
E _{AS}	Single Pulse Avalanche Energy (starting T _j = 25 °C, I _D = I _{AR} , V _{DD} = 50 V)	800	mJ
E _{AR}	Repetitive Avalanche Energy (pulse width limited by T _j max, δ < 1%)	18	mJ
I _{AR}	Avalanche Current, Repetitive or Not-Repetitive (T _c = 100 °C, pulse width limited by T _j max, δ < 1%)	4.5	A

ELECTRICAL CHARACTERISTICS (T_{case} = 25 °C unless otherwise specified)

OFF

Symbol	Parameter	Test Conditions	Min.	Typ.	Max.	Unit
V _{(BR)DSS}	Drain-source Breakdown Voltage	I _D = 250 μA V _{GS} = 0	800			V
I _{DSS}	Zero Gate Voltage Drain Current (V _{GS} = 0)	V _{DS} = Max Rating V _{DS} = Max Rating x 0.8 T _c = 125 °C			250 1000	μA μA
I _{GSS}	Gate-body Leakage Current (V _{DS} = 0)	V _{GS} = ± 20 V			± 100	nA

ON (*)

Symbol	Parameter	Test Conditions	Min.	Typ.	Max.	Unit
V _{GS(th)}	Gate Threshold Voltage	V _{DS} = V _{GS} I _D = 250 μA	2	3	4	V
R _{DS(on)}	Static Drain-source On Resistance	V _{GS} = 10V I _D = 4 A V _{GS} = 10V I _D = 4 A T _c = 100°C		0.98	1.2 2.4	Ω Ω
I _{D(on)}	On State Drain Current	V _{DS} > I _{D(on)} x R _{DS(on)max} V _{GS} = 10 V	8.2			A

DYNAMIC

Symbol	Parameter	Test Conditions	Min.	Typ.	Max.	Unit
g _{fs} (*)	Forward Transconductance	V _{DS} > I _{D(on)} x R _{DS(on)max} I _D = 4 A	4	7		S
C _{iss}	Input Capacitance	V _{DS} = 25 V f = 1 MHz V _{GS} = 0		2100	2700	pF
C _{oss}	Output Capacitance			270	350	pF
C _{rss}	Reverse Transfer Capacitance			115	150	pF

ELECTRICAL CHARACTERISTICS (continued)

SWITCHING ON

Symbol	Parameter	Test Conditions	Min.	Typ.	Max.	Unit
$t_{d(on)}$ t_r	Turn-on Time Rise Time	$V_{DD} = 400\text{ V}$ $I_D = 4\text{ A}$ $R_G = 50\ \Omega$ $V_{GS} = 10\text{ V}$ (see test circuit, figure 3)		90 280	120 350	ns ns
$(di/dt)_{on}$	Turn-on Current Slope	$V_{DD} = 640\text{ V}$ $I_D = 8\text{ A}$ $R_G = 50\ \Omega$ $V_{GS} = 10\text{ V}$ (see test circuit, figure 5)		145		A/ μ s
Q_g Q_{gs} Q_{gd}	Total Gate Charge Gate-Source Charge Gate-Drain Charge	$V_{DD} = 400\text{ V}$ $I_D = 8\text{ A}$ $V_{GS} = 10\text{ V}$		125 12 65	170	nC nC nC

SWITCHING OFF

Symbol	Parameter	Test Conditions	Min.	Typ.	Max.	Unit
$t_{r(voff)}$ t_f t_c	Off-voltage Rise Time Fall Time Cross-over Time	$V_{DD} = 640\text{ V}$ $I_D = 8\text{ A}$ $R_G = 50\ \Omega$ $V_{GS} = 10\text{ V}$ (see test circuit, figure 5)		160 50 235	200 65 300	ns ns ns

SOURCE DRAIN DIODE

Symbol	Parameter	Test Conditions	Min.	Typ.	Max.	Unit
I_{SD} $I_{SDM}(\bullet)$	Source-drain Current Source-drain Current (pulsed)				8.2 35	A A
$V_{SD} (*)$	Forward On Voltage	$I_{SD} = 8.2\text{ A}$ $V_{GS} = 0$			2.5	V
t_{rr} Q_{rr} I_{RRM}	Reverse Recovery Time Reverse Recovery Charge Reverse Recovery Current	$I_{SD} = 8.2\text{ A}$ $di/dt = 100\text{ A}/\mu\text{s}$ $V_R = 100\text{ V}$ $T_J = 150\text{ }^\circ\text{C}$ (see test circuit, figure 5)		900 24.8 55		ns μ C A

(*) Pulsed: Pulse duration = 300 μ s, duty cycle 1 5 %
 (•) Pulse width limited by safe operating area

Safe Operating Areas For TO-218 and TO-247

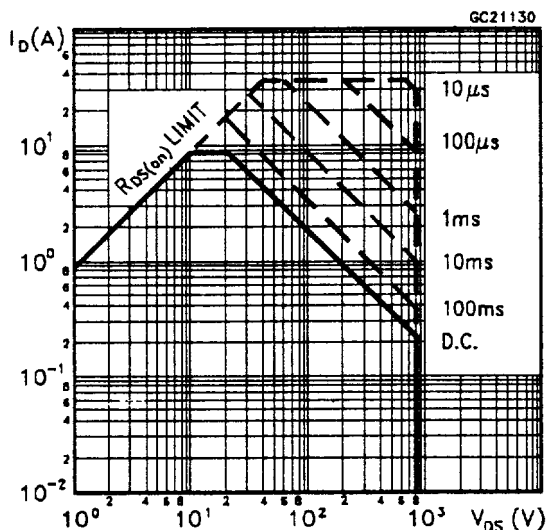

Safe Operating Areas For ISOWATT218

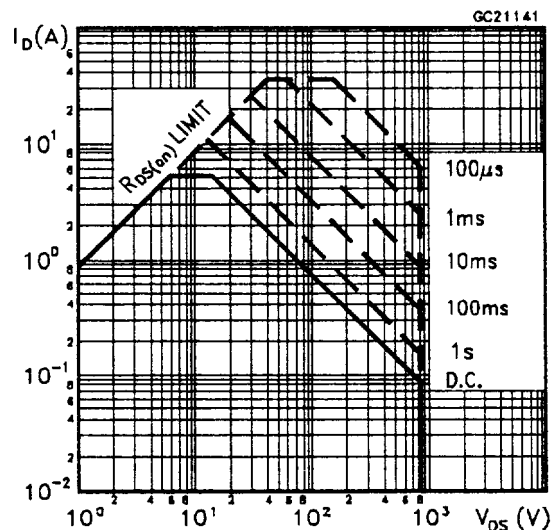

Thermal Impedance For TO-218 and TO-247

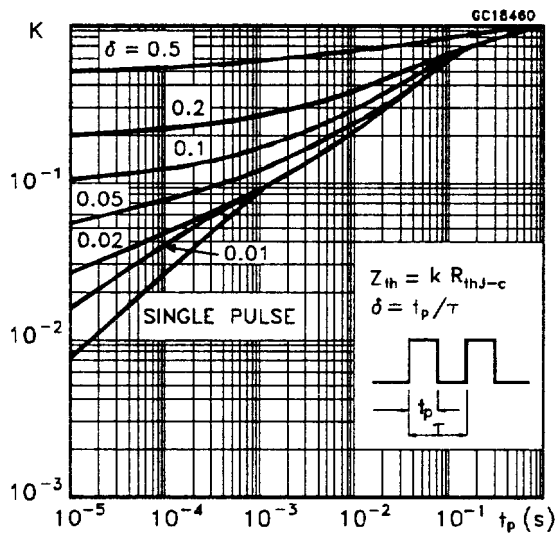

Thermal Impedance For ISOWATT218

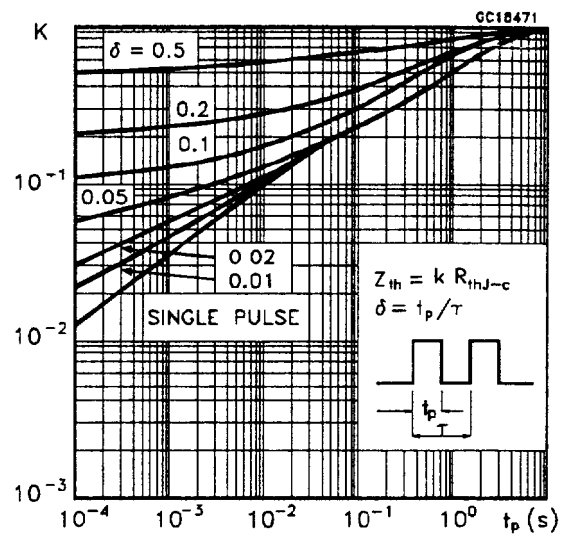

Derating Curve For TO-218 and TO-247

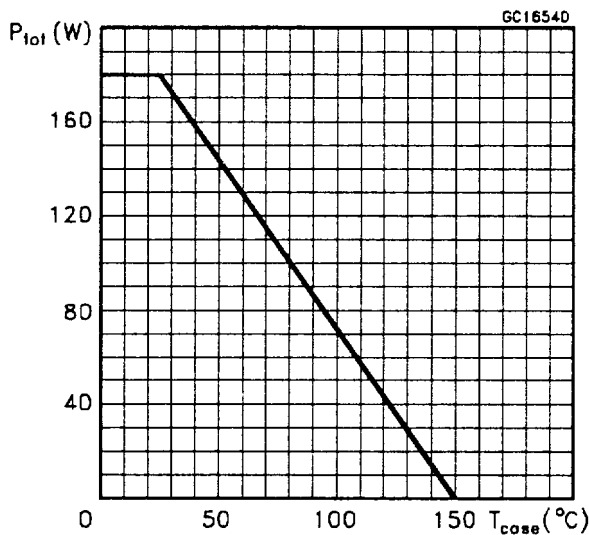

Derating Curve For ISOWATT218

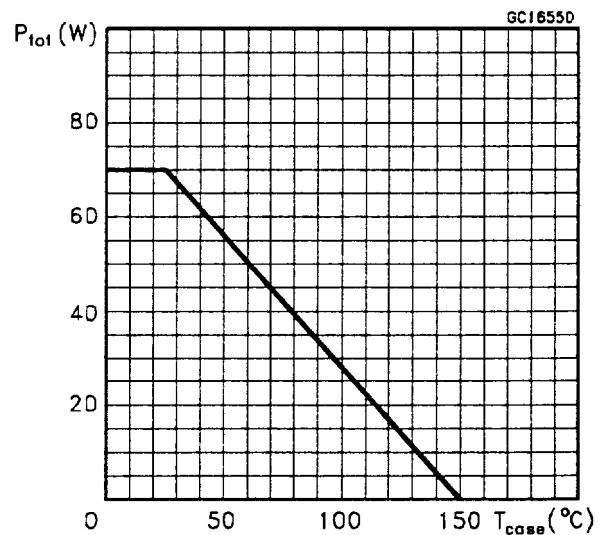

Output Characteristics

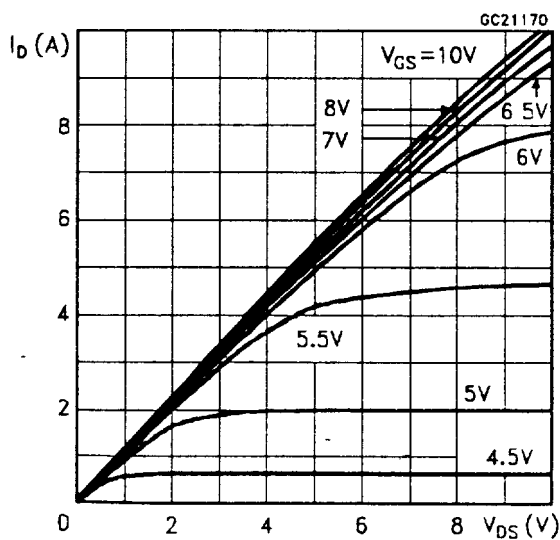

Transfer Characteristics

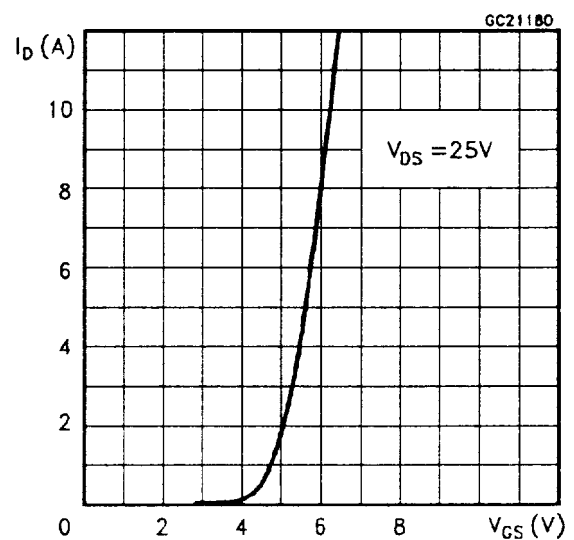

Transconductance

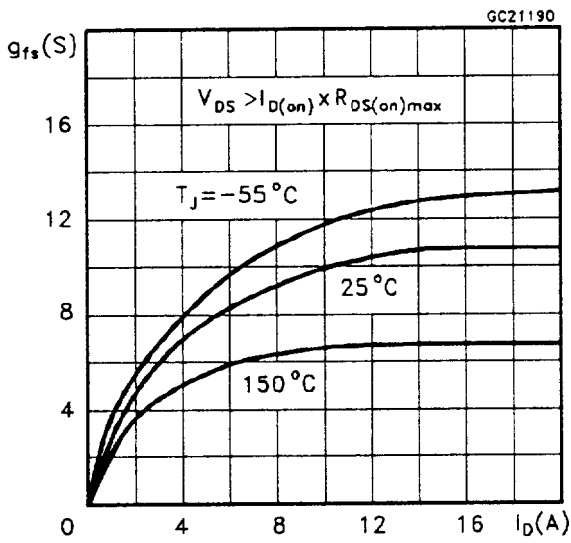

Static Drain-source On Resistance

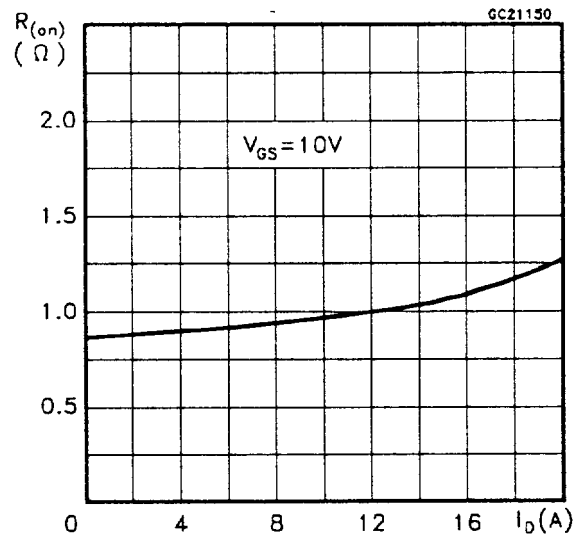

Gate Charge vs Gate-source Voltage

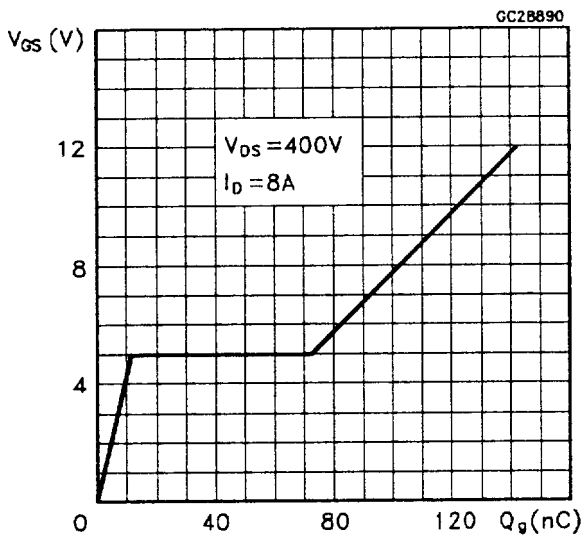

Capacitance Variations

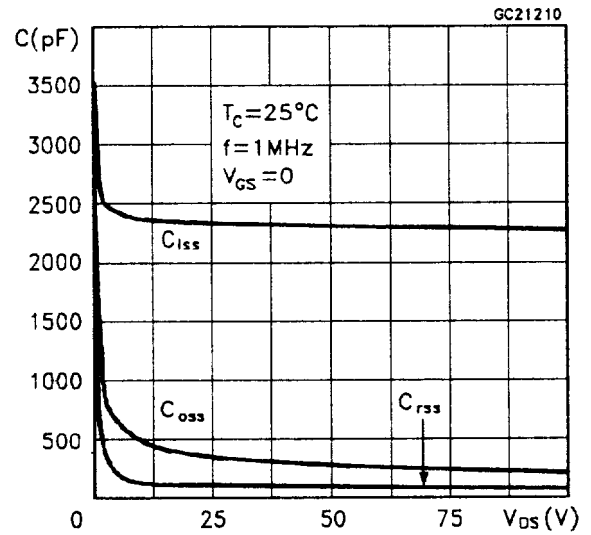

Normalized Gate Threshold Voltage vs Temperature

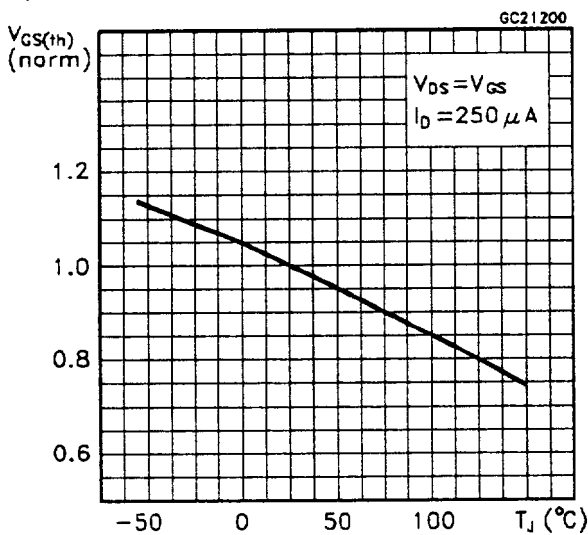

Normalized On Resistance vs Temperature

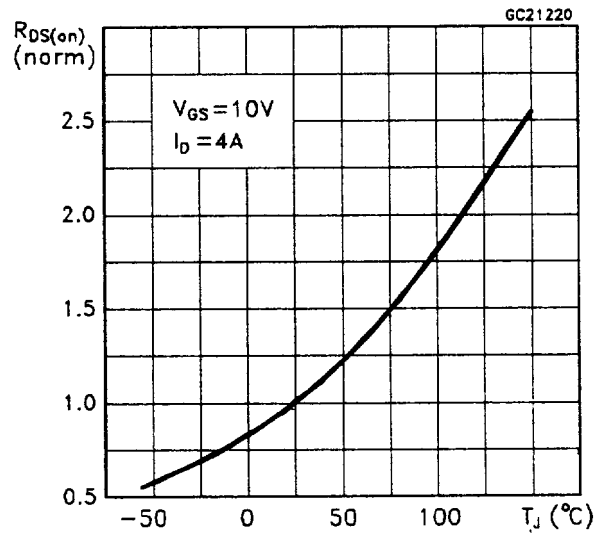

Turn-on Current Slope

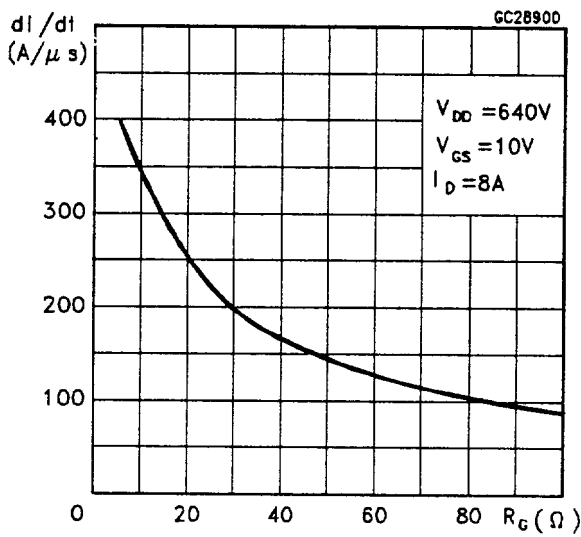

Turn-off Drain-source Voltage Slope

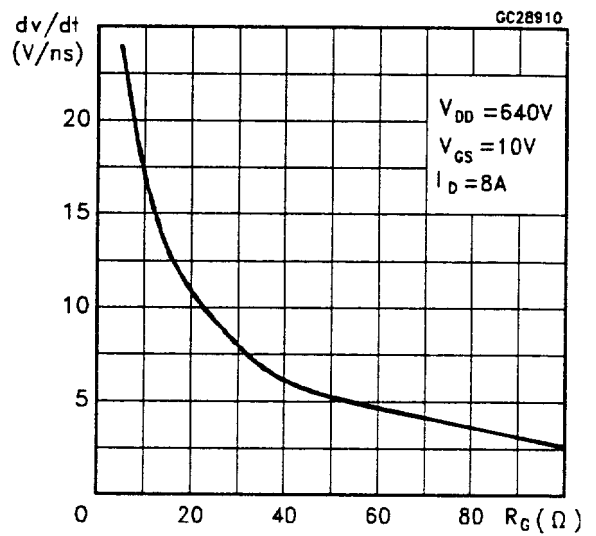

Cross-over Time

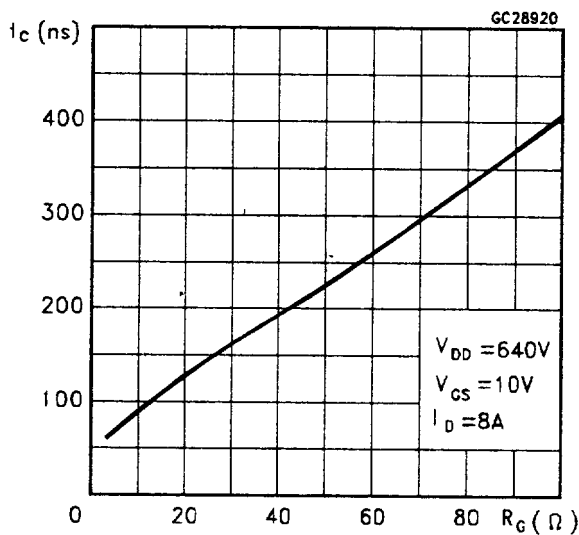

Switching Safe Operating Area

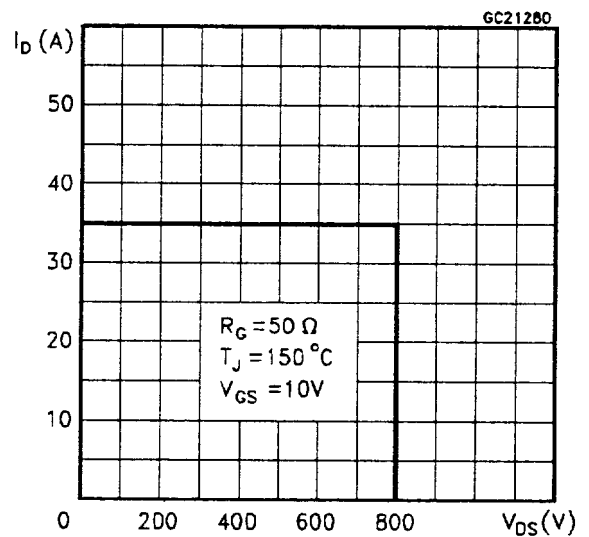

Accidental Overload Area

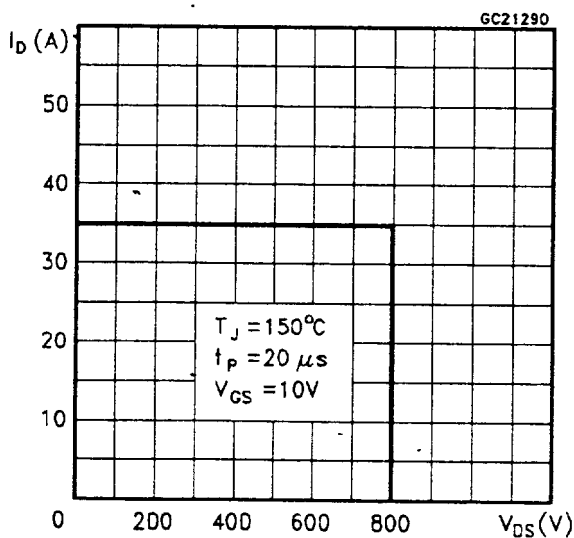

Source-drain Diode Forward Characteristics

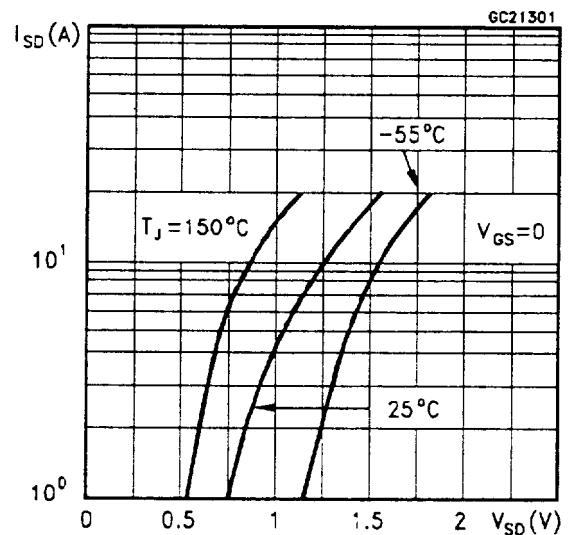

Fig. 1: Unclamped Inductive Load Test Circuits

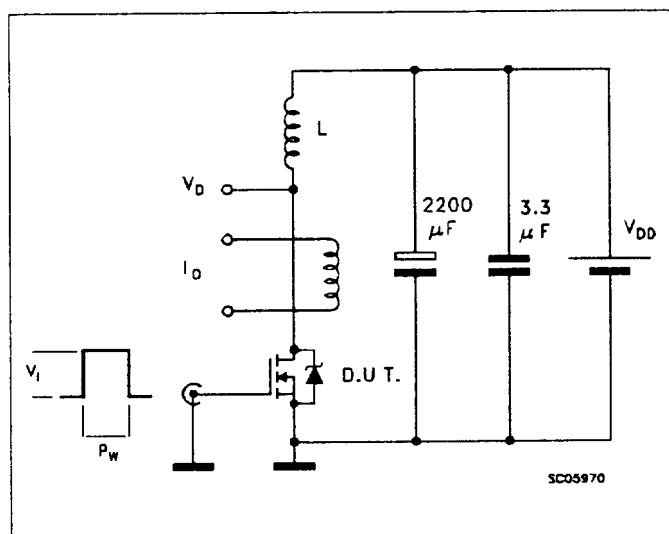

Fig. 2: Unclamped Inductive Waveforms

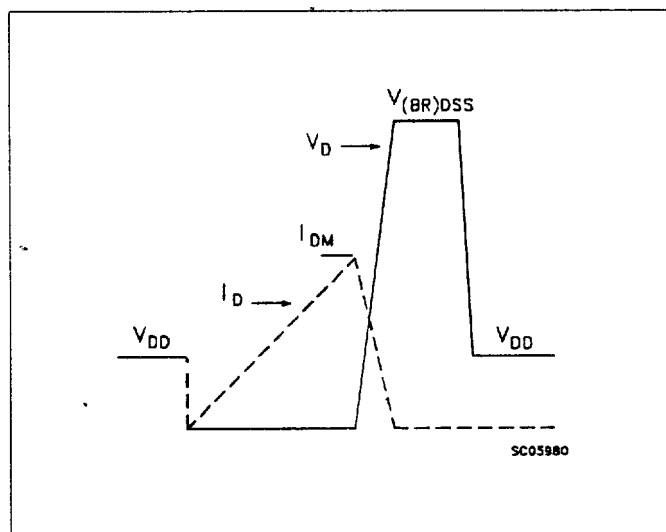

Fig. 3: Switching Times Test Circuits For Resistive Load

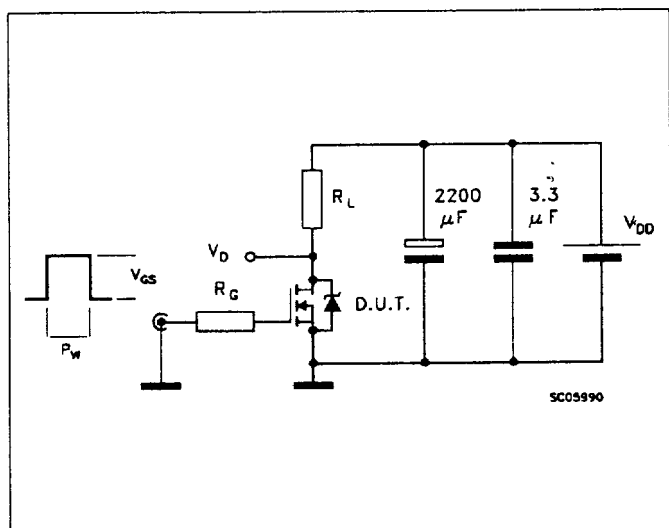

Fig. 4: Gate Charge Test Circuit

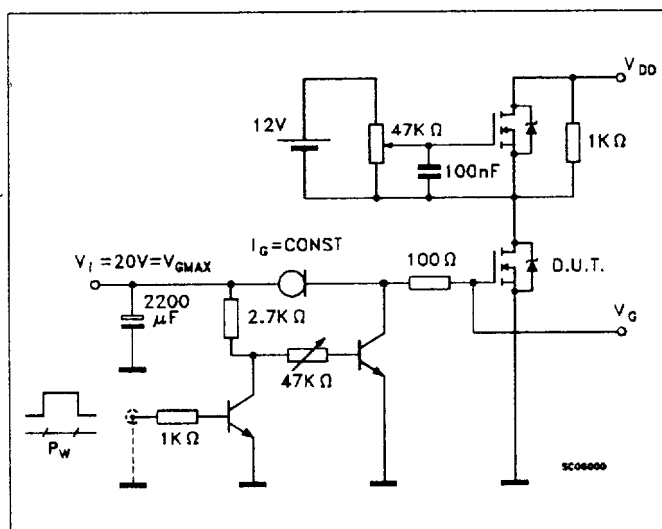

Fig. 5: Test Circuit For Inductive Load Switching And Diode Reverse Recovery Time

