

## N-channel 600 V, 0.06 $\Omega$ typ., 42 A MDmesh™ M2 Power MOSFET in a TO-247 long leads package

Datasheet - production data

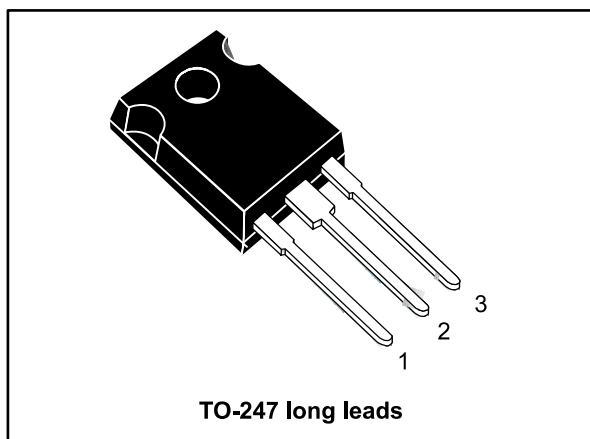
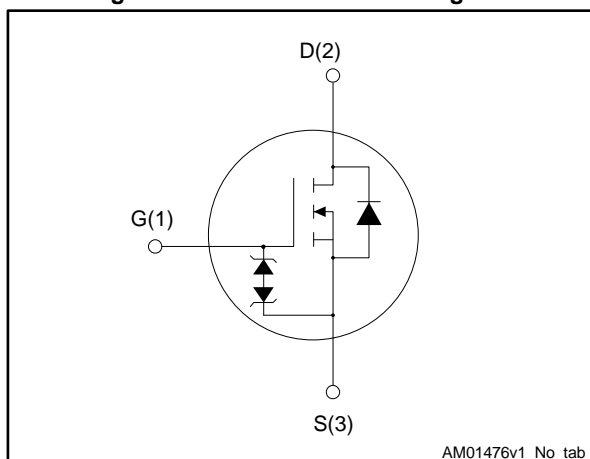

Figure 1: Internal schematic diagram



### Features

Order code	$V_{DS} @ T_{Jmax}$	$R_{DS(on)}$ max.	$I_D$
STWA48N60M2	650 V	0.07 $\Omega$	42 A

- Extremely low gate charge
- Excellent output capacitance ( $C_{OSS}$ ) profile
- 100% avalanche tested
- Zener-protected

### Applications

- Switching applications

### Description

This device is an N-channel Power MOSFET developed using MDmesh™ M2 technology. Thanks to its strip layout and an improved vertical structure, the device exhibits low on-resistance and optimized switching characteristics, rendering it suitable for the most demanding high efficiency converters.

Table 1: Device summary

Order code	Marking	Package	Packing
STWA48N60M2	48N60M2	TO-247 long leads	Tube

---

## Contents

<b>1</b>	<b>Electrical ratings .....</b>	<b>3</b>
<b>2</b>	<b>Electrical characteristics .....</b>	<b>4</b>
	2.2 Electrical characteristics (curves) .....	6
<b>3</b>	<b>Test circuits .....</b>	<b>8</b>
<b>4</b>	<b>Package mechanical data .....</b>	<b>9</b>
	4.1 TO-247 long leads package information .....	9
<b>5</b>	<b>Revision history .....</b>	<b>11</b>

# 1 Electrical ratings

**Table 2: Absolute maximum ratings**

Symbol	Parameter	Value	Unit
$V_{GS}$	Gate-source voltage	$\pm 25$	V
$I_D$	Drain current (continuous) at $T_C = 25\text{ }^\circ\text{C}$	42	A
$I_D$	Drain current (continuous) at $T_C = 100\text{ }^\circ\text{C}$	26	A
$I_{DM}^{(1)}$	Drain current (pulsed)	168	A
$P_{TOT}$	Total dissipation at $T_C = 25\text{ }^\circ\text{C}$	300	W
$dv/dt^{(2)}$	Peak diode recovery voltage slope	15	V/ns
$dv/dt^{(3)}$	MOSFET $dv/dt$ ruggedness	50	V/ns
$T_{stg}$	Storage temperature range	- 55 to 150	$^\circ\text{C}$
$T_j$	Operating junction temperature range		

**Notes:**

(1)Pulse width limited by safe operating area.

(2) $I_{SD} \leq 42\text{ A}$ ,  $di/dt \leq 400\text{ A}/\mu\text{s}$ ;  $V_{DS(\text{peak})} < V_{(BR)DSS}$ ,  $V_{DD} = 400\text{ V}$

(3) $V_{DS} \leq 480\text{ V}$

**Table 3: Thermal data**

Symbol	Parameter	Value	Unit
$R_{thj\text{-case}}$	Thermal resistance junction-case max.	0.42	$^\circ\text{C}/\text{W}$
$R_{thj\text{-amb}}$	Thermal resistance junction-ambient max.	50	$^\circ\text{C}/\text{W}$

**Table 4: Avalanche characteristics**

Symbol	Parameter	Value	Unit
$I_{AR}$	Avalanche current, repetitive or not repetitive (pulse width limited by $T_{j\text{max}}$ .)	7	A
$E_{AS}$	Single pulse avalanche energy (starting $T_j = 25\text{ }^\circ\text{C}$ , $I_D = I_{AR}$ ; $V_{DD} = 50\text{ V}$ )	1	J

## 2 Electrical characteristics

( $T_C = 25\text{ °C}$  unless otherwise specified)

**Table 5: On /off-states**

Symbol	Parameter	Test conditions	Min.	Typ.	Max.	Unit
$V_{(BR)DSS}$	Drain-source breakdown voltage	$V_{GS} = 0, I_D = 1\text{ mA}$	600			V
$I_{DSS}$	Zero-gate voltage drain current	$V_{GS} = 0, V_{DS} = 600\text{ V}$			1	$\mu\text{A}$
		$V_{GS} = 0, V_{DS} = 600\text{ V}, T_C = 125\text{ °C}^{(1)}$			100	$\mu\text{A}$
$I_{GSS}$	Gate-body leakage current	$V_{DS} = 0, V_{GS} = \pm 25\text{ V}$			$\pm 10$	$\mu\text{A}$
$V_{GS(th)}$	Gate threshold voltage	$V_{DS} = V_{GS}, I_D = 250\text{ }\mu\text{A}$	2	3	4	V
$R_{DS(on)}$	Static drain-source on-resistance	$V_{GS} = 10\text{ V}, I_D = 21\text{ A}$		0.06	0.07	$\Omega$

**Notes:**

<sup>(1)</sup>Defined by design, not subject to production test.

**Table 6: Dynamic**

Symbol	Parameter	Test conditions	Min.	Typ.	Max.	Unit
$C_{iss}$	Input capacitance	$V_{GS} = 0, V_{DS} = 100\text{ V}, f = 1\text{ MHz}$	-	3060	-	pF
$C_{oss}$	Output capacitance		-	143	-	pF
$C_{riss}$	Reverse transfer capacitance		-	4.3	-	pF
$C_{oss\text{ eq.}}^{(1)}$	Equivalent output capacitance	$V_{GS} = 0, V_{DS} = 0\text{ to }480\text{ V}$	-	630	-	pF
$R_G$	Intrinsic gate resistance	$f = 1\text{ MHz}, I_D = 0$	-	4.6	-	$\Omega$
$Q_g$	Total gate charge	$V_{DD} = 480\text{ V}, I_D = 42\text{ A}, V_{GS} = 10\text{ V}$ (see <a href="#">Figure 15: "Test circuit for gate charge behavior"</a> )	-	70	-	nC
$Q_{gs}$	Gate-source charge		-	10.5	-	nC
$Q_{gd}$	Gate-drain charge		-	31	-	nC

**Notes:**

<sup>(1)</sup> $C_{oss\text{ eq.}}$  is defined as a constant equivalent capacitance giving the same charging time as  $C_{oss}$  when  $V_{DS}$  increases from 0 to 80%  $V_{DSS}$ .

Table 7: Switching times

Symbol	Parameter	Test conditions	Min.	Typ.	Max.	Unit
$t_{d(on)}$	Turn-on delay time	$V_{DD} = 300\text{ V}$ , $I_D = 21\text{ A}$ , $R_G = 4.7\ \Omega$ , $V_{GS} = 10\text{ V}$ (see <a href="#">Figure 14: "Test circuit for resistive load switching times"</a> and <a href="#">Figure 19: "Switching time waveform"</a> )	-	18.5	-	ns
$t_r$	Rise time		-	17	-	ns
$t_{d(off)}$	Turn-off-delay time		-	13	-	ns
$t_f$	Fall time		-	119	-	ns

Table 8: Source-drain diode

Symbol	Parameter	Test conditions	Min.	Typ.	Max.	Unit
$I_{SD}$	Source-drain current		-		42	A
$I_{SDM}^{(1)}$	Source-drain current (pulsed)		-		168	A
$V_{SD}^{(2)}$	Forward on voltage	$V_{GS} = 0$ , $I_{SD} = 21\text{ A}$	-		1.6	V
$t_{rr}$	Reverse recovery time	$I_{SD} = 42\text{ A}$ , $di/dt = 100\text{ A}/\mu\text{s}$ $V_{DD} = 60\text{ V}$ (see <a href="#">Figure 17: "Unclamped inductive load test circuit"</a> )	-	487		ns
$Q_{rr}$	Reverse recovery charge		-	9.1		$\mu\text{C}$
$I_{RRM}$	Reverse recovery current		-	37.5		A
$t_{rr}$	Reverse recovery time	$I_{SD} = 42\text{ A}$ , $di/dt = 100\text{ A}/\mu\text{s}$ $V_{DD} = 60\text{ V}$ , $T_j = 150\text{ }^\circ\text{C}$ (see <a href="#">Figure 17: "Unclamped inductive load test circuit"</a> )	-	605		ns
$Q_{rr}$	Reverse recovery charge		-	12.5		$\mu\text{C}$
$I_{RRM}$	Reverse recovery current		-	41.5		A

**Notes:**

(1)Pulse width limited by safe operating area.

(2)Pulsed: pulse duration = 300  $\mu\text{s}$ , duty cycle 1.5%.

## 2.2 Electrical characteristics (curves)

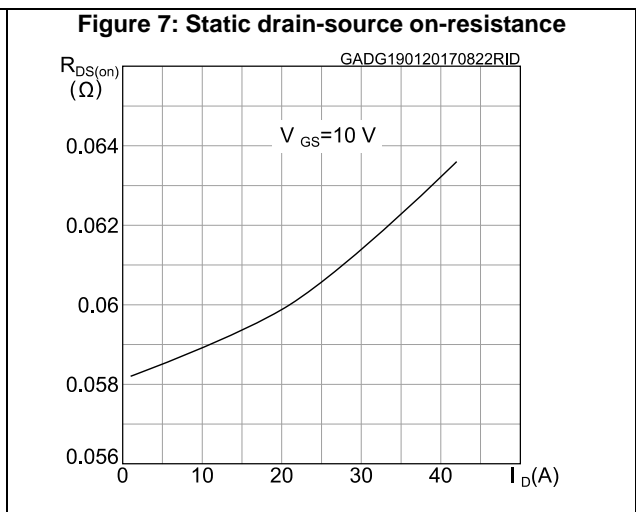
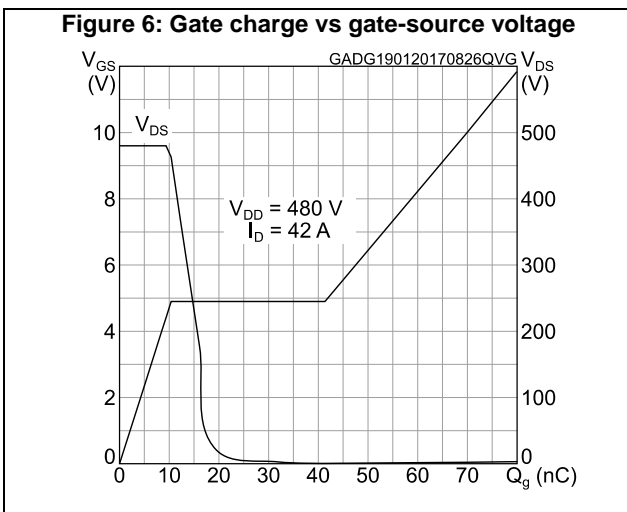
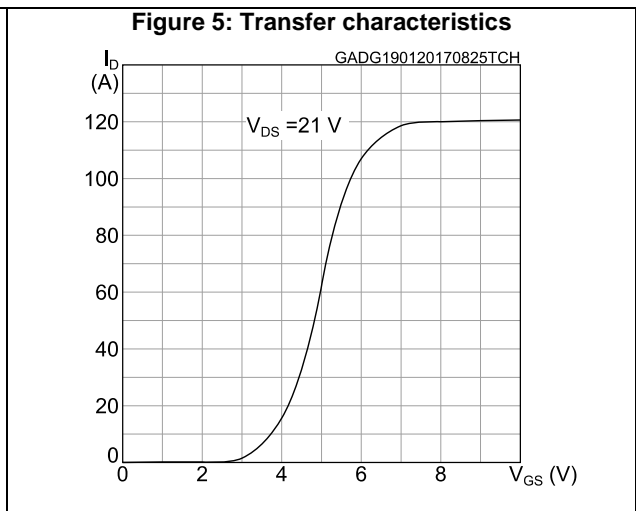
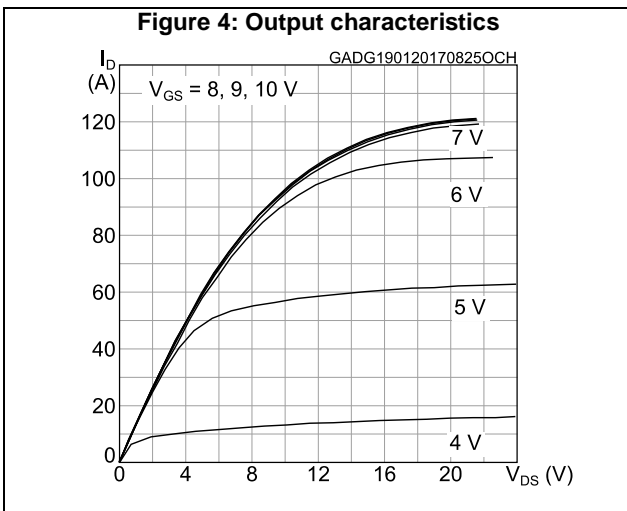
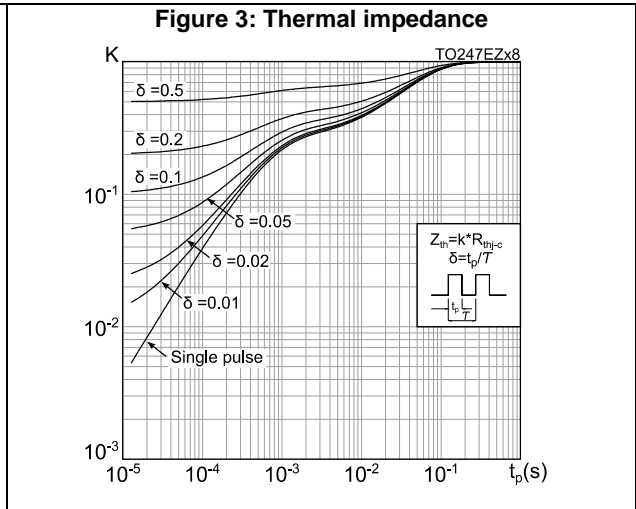
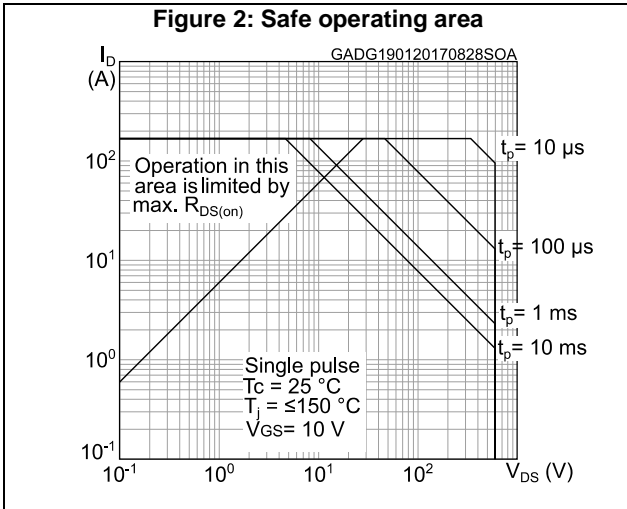

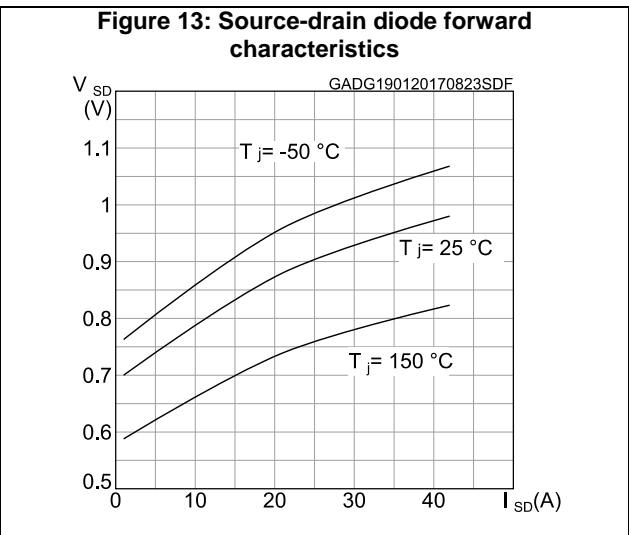
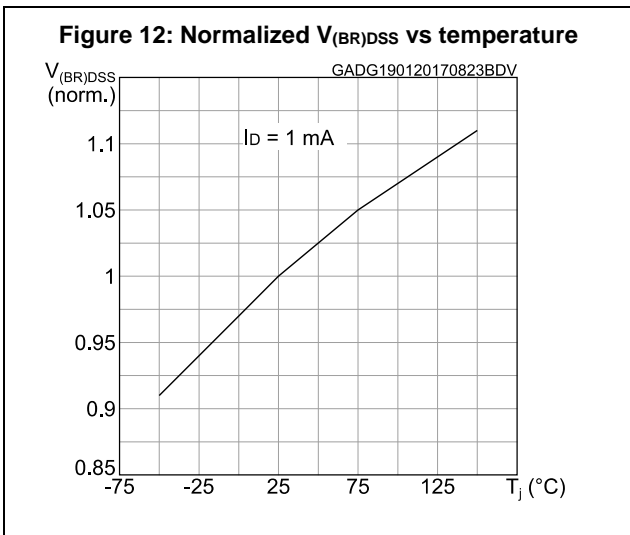
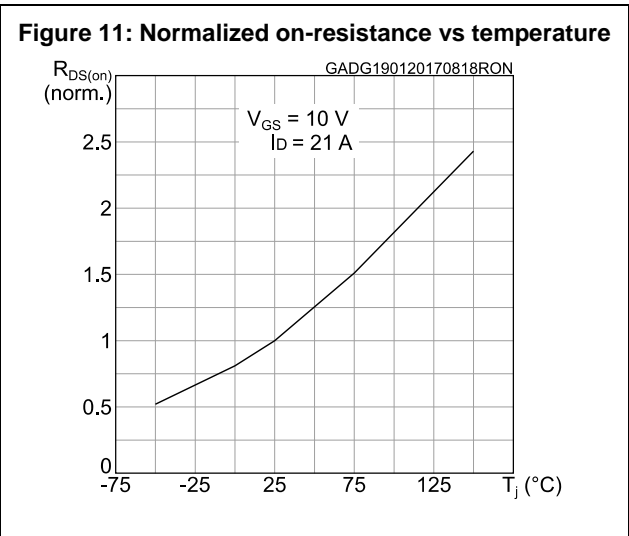
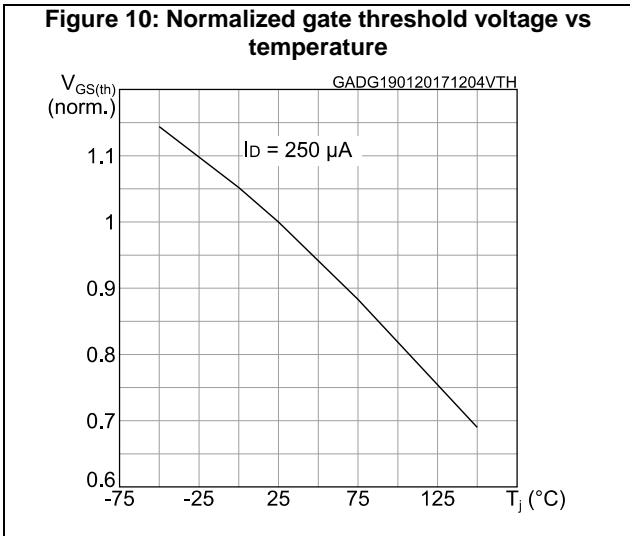
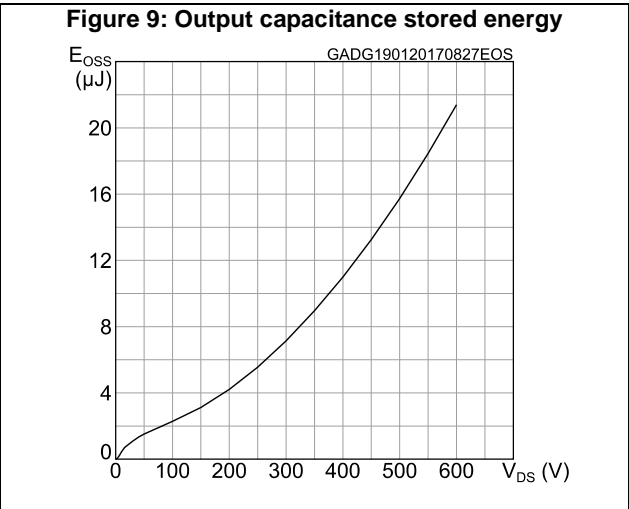
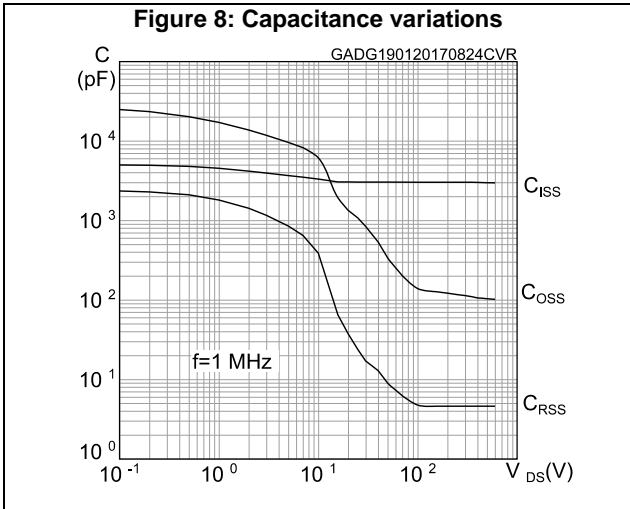

### 3 Test circuits

**Figure 14: Test circuit for resistive load switching times**



AM01468v1

**Figure 15: Test circuit for gate charge behavior**



AM01469v1

**Figure 16: Test circuit for inductive load switching and diode recovery times**

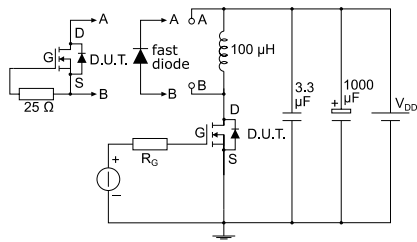

AM01470v1

**Figure 17: Unclamped inductive load test circuit**

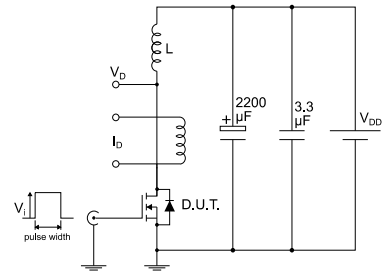

AM01471v1

**Figure 18: Unclamped inductive waveform**

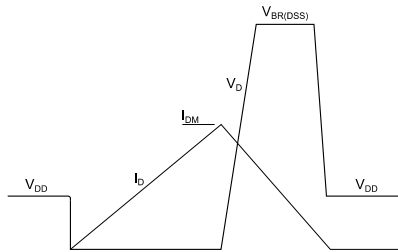

AM01472v1

**Figure 19: Switching time waveform**

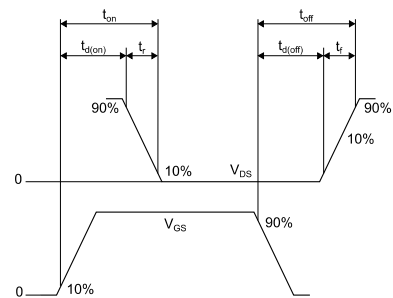

AM01473v1



## 4 Package mechanical data

In order to meet environmental requirements, ST offers these devices in different grades of ECOPACK® packages, depending on their level of environmental compliance. ECOPACK® specifications, grade definitions and product status are available at: [www.st.com](http://www.st.com). ECOPACK is an ST trademark.

### 4.1 TO-247 long leads package information

Figure 20: TO-247 long leads package outline

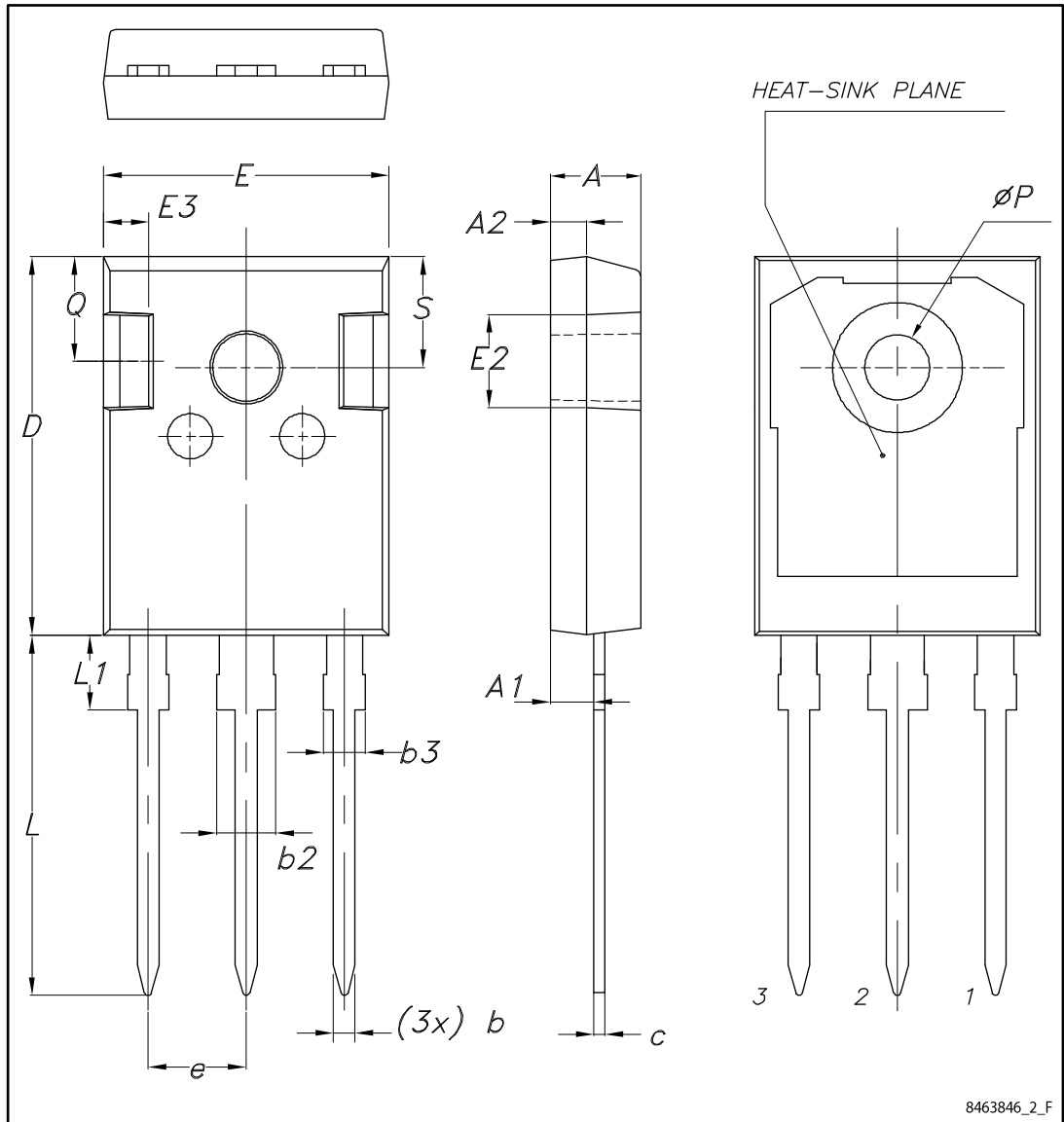

Table 9: TO-247 long leads package mechanical data

Dim.	mm		
	Min.	Typ.	Max.
A	4.90	5.00	5.10
A1	2.31	2.41	2.51
A2	1.90	2.00	2.10
b	1.16		1.26
b2			3.25
b3			2.25
c	0.59		0.66
D	20.90	21.00	21.10
E	15.70	15.80	15.90
E2	4.90	5.00	5.10
E3	2.40	2.50	2.60
e	5.34	5.44	5.54
L	19.80	19.92	20.10
L1			4.30
P	3.50	3.60	3.70
Q	5.60		6.00
S	6.05	6.15	6.25

## 5 Revision history

Table 10: Document revision history

Date	Revision	Changes
01-Dec-2015	1	First release.
20-Jan-2017	2	Updated <a href="#">Table 2: "Absolute maximum ratings"</a> , <a href="#">Table 4: "Avalanche characteristics"</a> , <a href="#">Table 5: "On /off-states"</a> , <a href="#">Table 6: "Dynamic"</a> and <a href="#">Table 7: "Switching times"</a> . Updated <a href="#">Section 2.2: "Electrical characteristics (curves)"</a> .

**IMPORTANT NOTICE – PLEASE READ CAREFULLY**

STMicroelectronics NV and its subsidiaries ("ST") reserve the right to make changes, corrections, enhancements, modifications, and improvements to ST products and/or to this document at any time without notice. Purchasers should obtain the latest relevant information on ST products before placing orders. ST products are sold pursuant to ST's terms and conditions of sale in place at the time of order acknowledgement.

Purchasers are solely responsible for the choice, selection, and use of ST products and ST assumes no liability for application assistance or the design of Purchasers' products.

No license, express or implied, to any intellectual property right is granted by ST herein.

Resale of ST products with provisions different from the information set forth herein shall void any warranty granted by ST for such product.

ST and the ST logo are trademarks of ST. All other product or service names are the property of their respective owners.

Information in this document supersedes and replaces information previously supplied in any prior versions of this document.

© 2017 STMicroelectronics – All rights reserved