

Integrated Power MOSFET with PNP Low $V_{CE(sat)}$ Switching Transistor

This integrated device represents a new level of safety and board-space reduction by combining the 20V P-Channel FET with a PNP Silicon Low $V_{CE(sat)}$ switching transistor. This newly integrated product provides higher efficiency and accuracy for battery powered portable electronics.

Features

- Low $R_{DS(on)}$ (MOSFET) and Low $V_{CE(sat)}$ (Transistor)
- Higher Efficiency Extending Battery Life
- Logic Level Gate Drive (MOSFET)
- Performance DFN Package
- This is a Halogen-Free Device

Applications

- Power Management in Portable and Battery-Powered Products; i.e., Cellular and Cordless Telephones and PCMCIA Cards

Ordering Information

Device	Marking	Package
SUM201MN	SUM201	DFN8

Simple Schematic

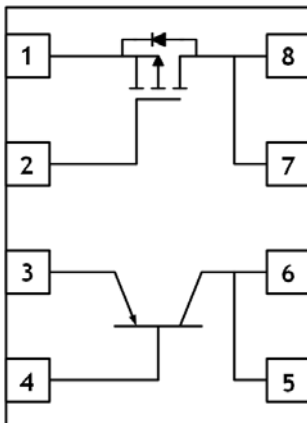

DFN-8

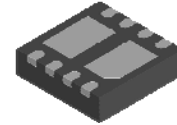

MOSFET

BV_{DSS}	$R_{DS(ON)}$ Typ.	I_D Max
-20V	48m Ω @ $V_{GS}=-4.5V$	-5.3A
	65m Ω @ $V_{GS}=-2.5V$	

PNP BJT

BV_{CEO}	BV_{EBO}	I_C Max
-20V	-5V	-5A

Marking Diagram

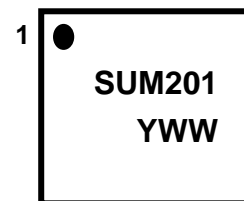

Column 1 : Device Code
Column 2 : Date Code (year, week)

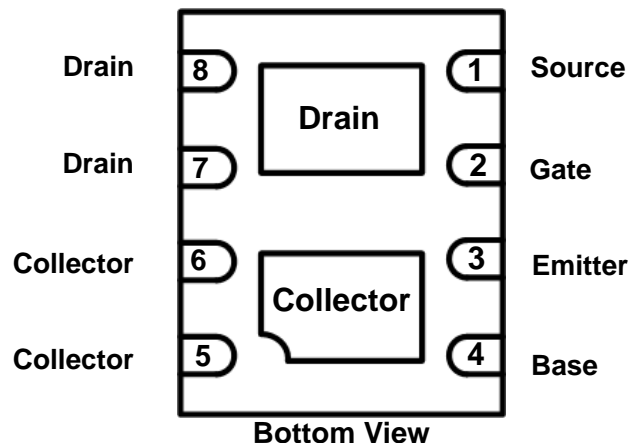

Absolute maximum ratings for P-Ch MOSFET

(Ta=25°C)

Characteristic	Symbol	Rating		Unit	
		5sec	Steady State		
Drain-source voltage	V_{DSS}	-20		V	
Gate-source voltage	V_{GSS}	±12		V	
Drain current (DC) ^(Note.1)	I_D	$T_A=25^\circ\text{C}$	-5.3	-3.9	A
		$T_A=85^\circ\text{C}$	-3.8	-2.8	A
Drain current (Pulsed)	I_{DP}	±20		A	
Continuous Source current	I_S	-5.3	-3.9	A	
Total Power dissipation ^(Note.1)	P_D	$T_A=25^\circ\text{C}$	2.5	1.3	W
		$T_A=85^\circ\text{C}$	1.3	0.7	W
Operating Junction and Storage Temperature Range	T_J, T_{stg}	-55 ~ 150		°C	

Absolute maximum ratings for PNP Transistor

(Ta=25°C)

Characteristic	Symbol	Rating	Unit
Collector-Base voltage	V_{CBO}	-35	V
Collector-Emitter voltage	V_{CEO}	-20	V
Emitter-Base voltage	V_{EBO}	-5	V
Collector current – continuous	I_C	-5	A
Peak Collector current	I_{CM}	-10	A

Thermal Characteristics for P-Ch MOSFET

Characteristic	Symbol	Condition	Typ.	Max.	Unit
Junction to Ambient ^(Note.5)	$R_{TH(J-A)}$	$t \leq 5$ sec	40	50	°C/W
		Steady State	80	95	
Junction to Foot (Drain)	$R_{TH(J-F)}$	Steady State	15	20	°C/W

Thermal Characteristics for PNP Transistor

Characteristic	Symbol	Max.	Unit
Total Device Dissipation	P_D ^(Note.2)	635	mW
Thermal Resistance, Junction to Ambient	$R_{TH(J-A)}$ ^(Note.2)	200	°C/W
Total Device Dissipation	P_D ^(Note.3)	1.35	W
Thermal Resistance, Junction to Ambient	$R_{TH(J-A)}$ ^(Note.3)	90	°C/W
Thermal Resistance, Junction to Lead #1	$R_{TH(J-L)}$	15	°C/W
Total Device Dissipation (Single Pulse < 10 sec)	$P_{Dsingle}$ ^(Note.3&4)	2.75	W
Junction and Storage Temperature Range	T_J, T_{stg}	-55 ~ 150	°C

1. Surface Mounted on FR4 Board using 1in square pad size (Cu area =1.27 in square [1 oz] including traces)

2. FR-4 @ 100 mm², 1 oz copper traces.

3. FR-4 @ 500 mm², 1 oz copper traces.

4. Thermal response.

Electrical Characteristics for P-Ch MOSFET

(Ta=25°C)

Characteristic	Symbol	Test Condition	Min.	Typ.	Max.	Unit
Static						
Drain-source breakdown voltage	BV_{DSS}	$I_D = -250\mu A, V_{GS} = 0$	-20	-	-	V
Gate threshold voltage	$V_{GS(th)}$	$I_D = -250\mu A, V_{DS} = V_{GS}$	-0.6		-1.2	V
Drain-source cut-off current	I_{DSS}	$V_{DS} = -20V, V_{GS} = 0V$	-	-	-1	μA
Gate leakage current	I_{GSS}	$V_{DS} = 0V, V_{GS} = \pm 12V$	-	-	± 100	nA
On-State Drain Current ^(Note.6)	$I_{D(ON)}$	$V_{DS} \leq -5.0V, V_{GS} = -4.5V$	-20	-	-	A
Drain-source on-resistance ^(Note.6)	$R_{DS(ON)}$	$V_{GS} = -3.6V, I_D = -1.0A$	-	50	60	m Ω
		$V_{GS} = -2.5V, I_D = -1.0A$	-	70	83	
Forward transfer conductance ^(Note.6)	g_{fs}	$V_{DS} = -10V, I_D = -3.9A$	-	12	-	S
Diode Forward Voltage ^(Note.6)	V_{SD}	$I_S = -2.1A, V_{GS} = 0V$	-	-0.8	-1.2	V
Dynamic ^(Note.7)						
Input capacitance	C_{iss}	$V_{GS} = 0V, V_{DS} = -5V, f = 1MHz$	-	710	-	pF
Output capacitance	C_{oss}		-	400	-	
Reverse transfer capacitance	C_{rss}		-	140	-	
Turn-on delay time	$t_{d(on)}$	$V_{DD} = -10V, I_D = -1.0A, R_G = 6\Omega, R_D = 10\Omega, V_{GS} = -4.5V$	-	14	30	ns
Rise time	t_r		-	22	55	
Turn-off delay time	$t_{d(off)}$		-	42	100	
Fall time	t_f		-	35	70	
Total gate charge	Q_g	$V_{DD} = -10V, V_{GS} = -4.5V, I_D = -3.9A$	-	9.7	22	nC
Gate-source charge	Q_{gs}		-	1.2	-	
Gate-drain charge	Q_{gd}		-	3.6	-	

5. Surface Mounted on FR4 Board using 1 inch square pad size (Cu area =1.27 inch square [1 oz] including traces).

6. Pulse Test : Pulse Width $\leq 300\mu s$, Duty Cycle $\leq 2\%$.

7. Guaranteed by design, not subject to production testing.

Electrical Characteristics for PNP Transistor

(Ta=25°C)

Characteristic	Symbol	Test Condition	Min.	Typ.	Max.	Unit
Off Characteristics						
Collector-Base breakdown voltage	BV_{CBO}	$I_C = -50\mu A, I_E = 0$	-35	-	-	V
Collector-Emitter breakdown voltage	BV_{CEO}	$I_C = -1mA, I_B = 0$	-20	-	-	V
Emitter-Base breakdown voltage	BV_{EBO}	$I_E = -50\mu A, I_C = 0$	-5	-	-	V
Collector cut-off current	I_{CBO}	$V_{CB} = -35V, I_E = 0$	-	-	-1	μA
Emitter cut-off current	I_{EBO}	$V_{EB} = -5V, I_C = 0$	-	-	-1	μA
On Characteristics						
DC current gain (Note.8)	h_{FE}^*	$V_{CE} = -2V, I_C = -500mA$	200	-	400	-
Collector-Emitter saturation voltage (Note.8)	$V_{CE(sat)}$	$I_C = -3A, I_B = -150mA$	-	-	-0.5	V
Transition frequency	f_T	$V_{CB} = -5V, I_C = -50mA$	-	180	-	MHz
Collector output capacitance	C_{ob}	$V_{CB} = -10V, I_E = 0, f = 1MHz$	-	42	-	pF

8. Pulse Test : Pulse Width $\leq 300\mu s$, Duty Cycle $\leq 2\%$.

Typical Characteristic Curves (P-Channel MOSFET)

Fig. 1 $I_D - V_{DS}$

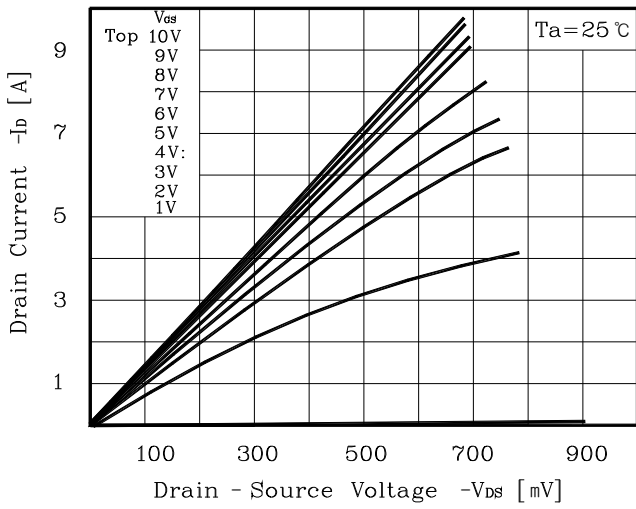

Fig. 2 $I_D - V_{GS}$

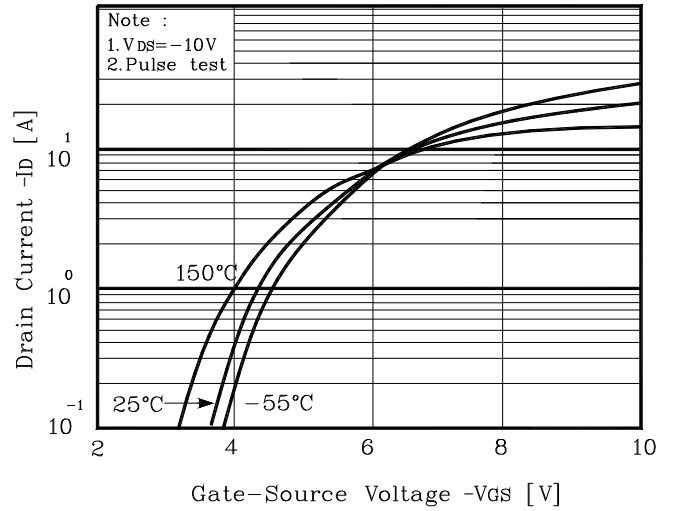

Fig. 3 $R_{DS(on)} - I_D$

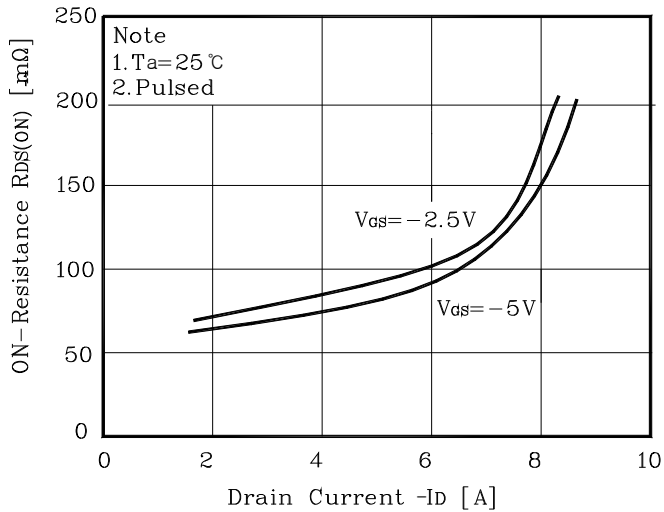

Fig. 4 $I_S - V_{SD}$

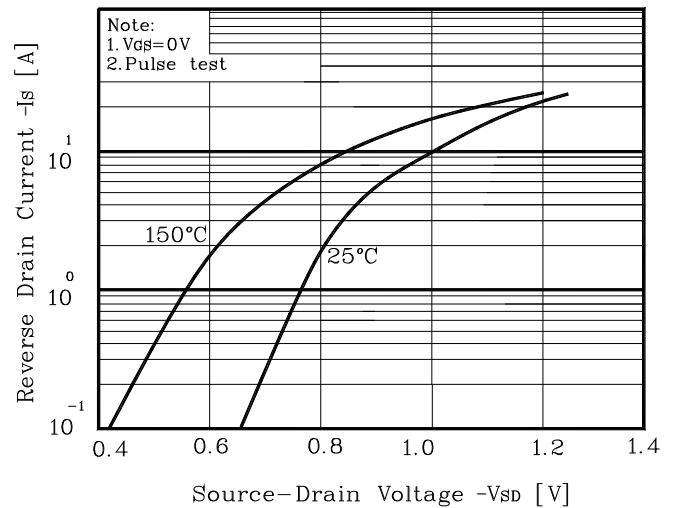

Fig. 5 Capacitance - V_{DS}

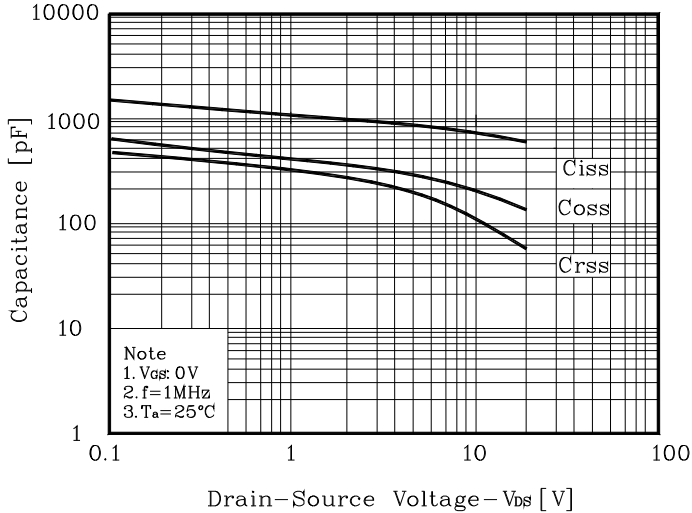
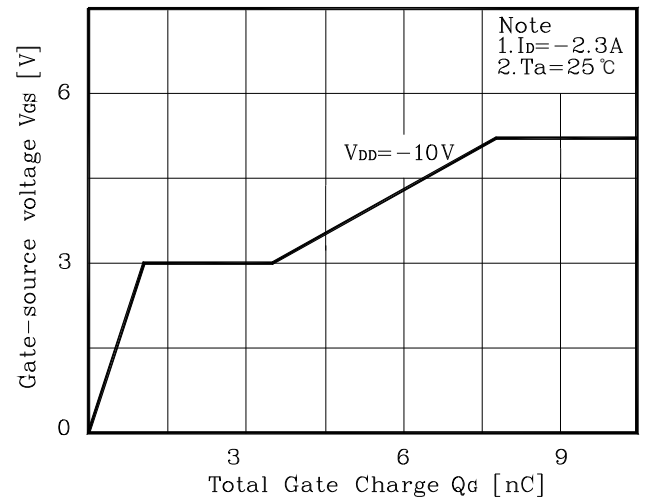

Fig. 6 $V_{GS} - Q_G$



Typical Characteristics (P-Channel MOSFET)

Fig. 7 $V_{DSS} - T_J$

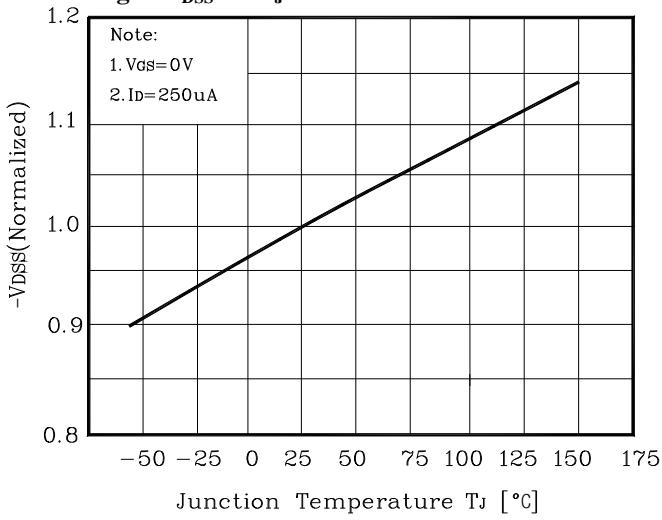

Fig. 8 $R_{DS(on)} - T_J$

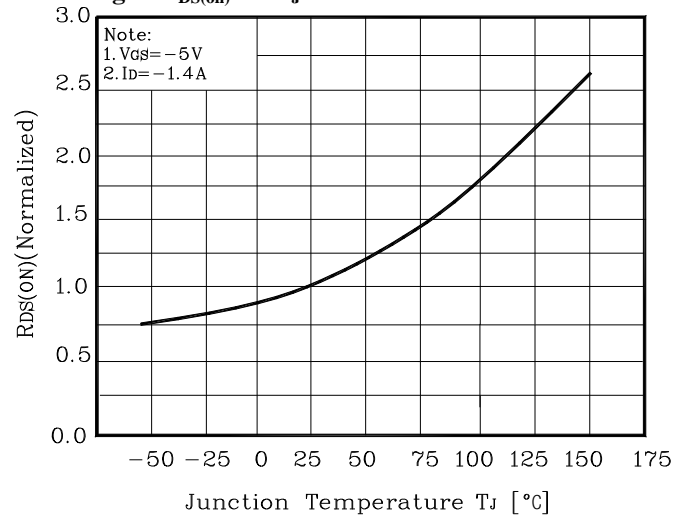
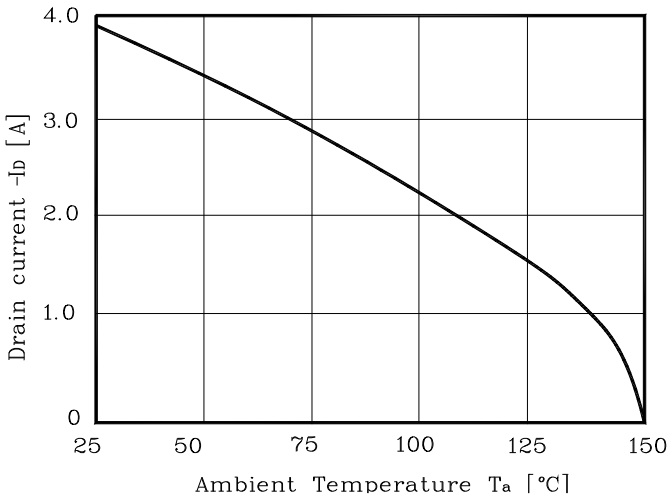

Fig. 9 $I_D - T_a$



Typical Characteristic Curves (PNP BJT)

Fig. 1 $P_c - T_a$

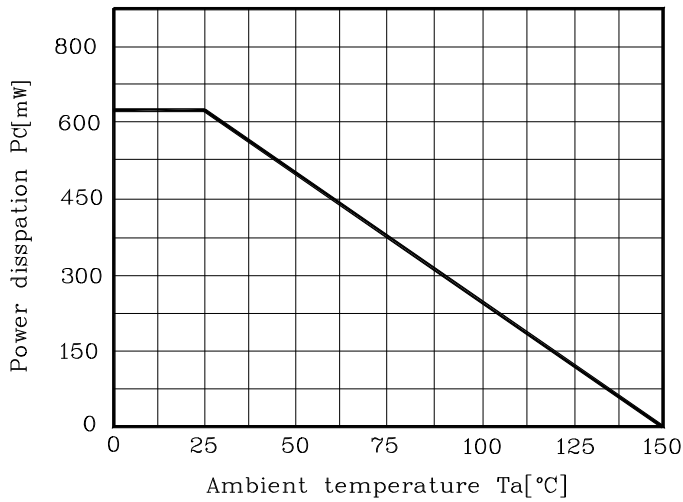

Fig. 2 $I_c - V_{BE}$

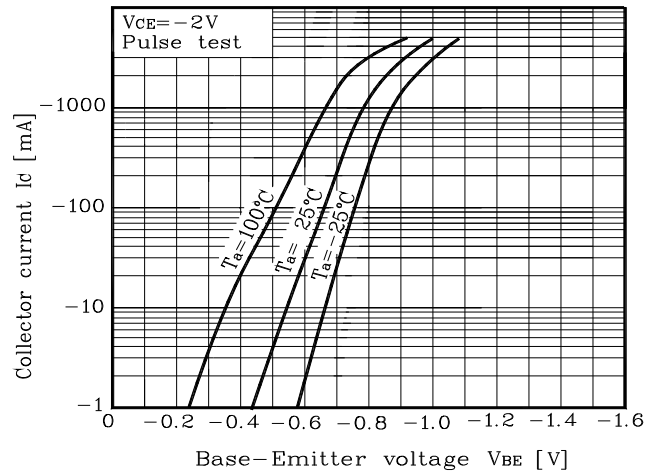

Fig. 3 $h_{FE} - I_c$

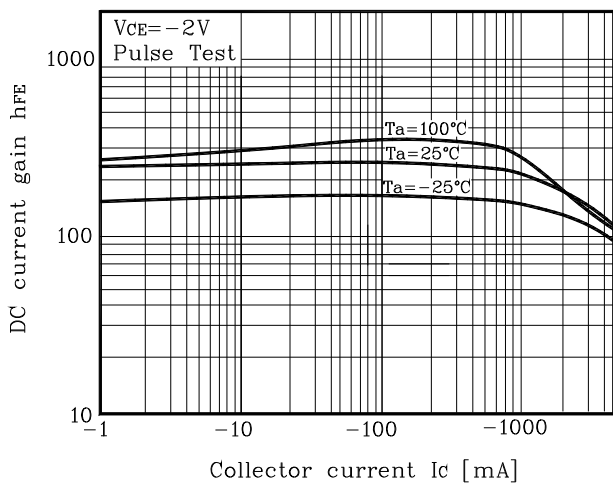

Fig. 4 $V_{CE(sat)} - I_c$

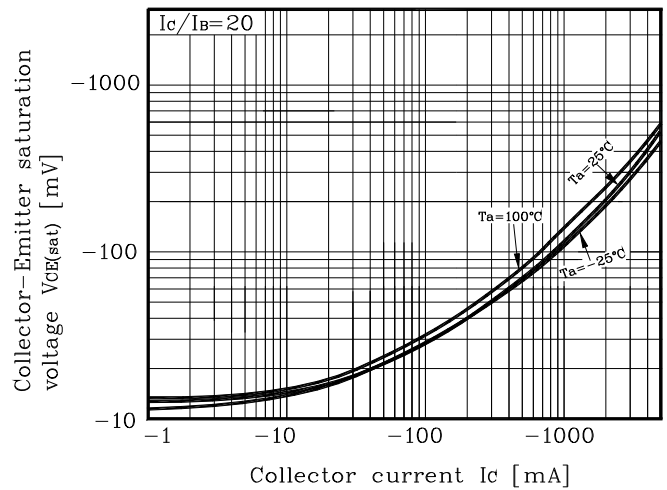
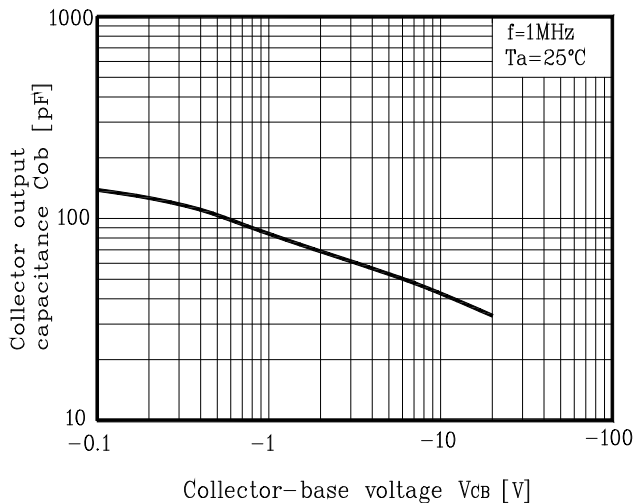
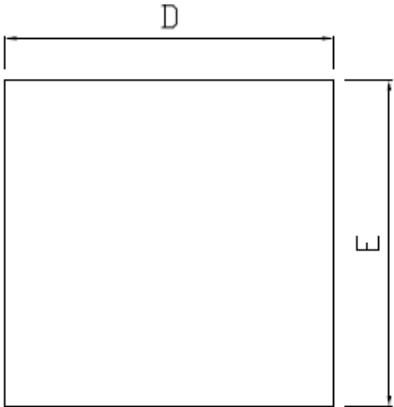

Fig. 5 $C_{ob} - V_{CB}$



Outline Dimension

unit : mm



TOP VIEW

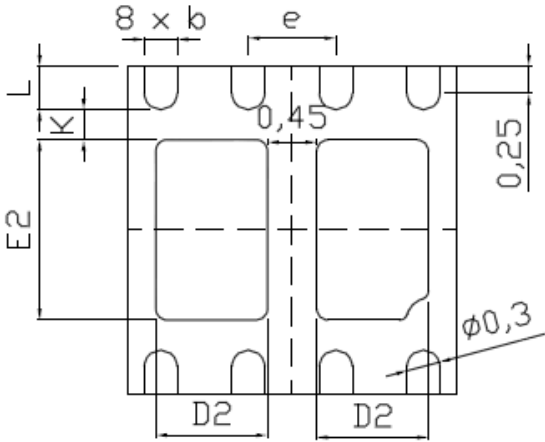

BOTTOM VIEW

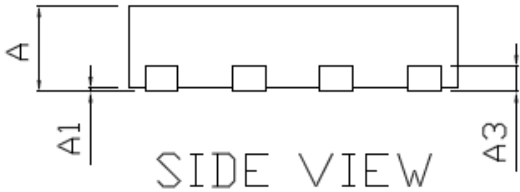

SIDE VIEW

DIMENSIONS(MM)			
REF.	MIN.	NOM.	MAX
A	0.70	0.75	0.80
A1	0.00	-	0.05
A3	0.20 REF.		
D	2.95	3.00	3.05
E	2.95	3.00	3.05
D2	0.87	1.02	1.12
E2	1.50	1.65	1.75
b	0.25	0.30	0.35
L	0.30	0.40	0.50
K	Min : 0.21		
e	0.80 BSC		

※ Recommended Land Pattern [unit: mm]

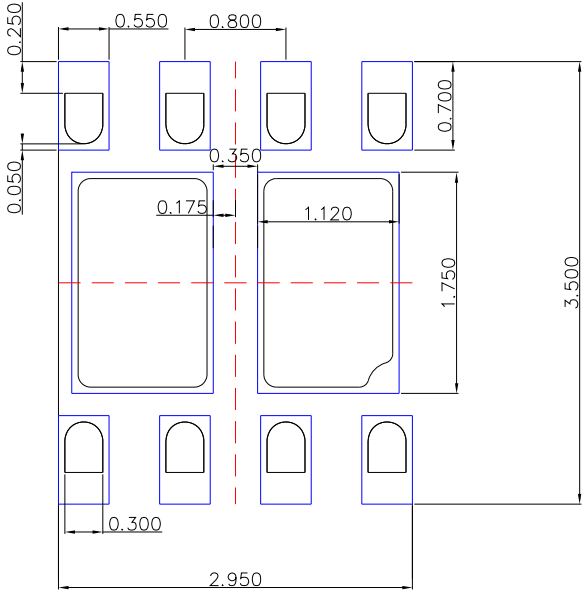

The AUK Corp. products are intended for the use as components in general electronic equipment (Office and communication equipment, measuring equipment, home appliance, etc.).

Please make sure that you consult with us before you use these AUK Corp. products in equipments which require high quality and / or reliability, and in equipments which could have major impact to the welfare of human life(atomic energy control, airplane, spaceship, transportation, combustion control, all types of safety device, etc.). AUK Corp. cannot accept liability to any damage which may occur in case these AUK Corp. products were used in the mentioned equipments without prior consultation with AUK Corp..

Specifications mentioned in this publication are subject to change without notice.