



New Product

SUM60N08-07T

Vishay Siliconix

## N-Channel 75-V (D-S) MOSFET with Sensing Diode

### PRODUCT SUMMARY

$V_{(BR)DSS}$ (V)	$r_{DS(on)}$ ( $\Omega$ )	$I_D$ (A)
75	0.007 @ $V_{GS} = 10$ V	60 <sup>a</sup>

### FEATURES

- TrenchFET® Power MOSFET Plus Temperature Sensing Diode
- New Low Thermal Resistance Package

### APPLICATIONS

- Automotive
- Industrial

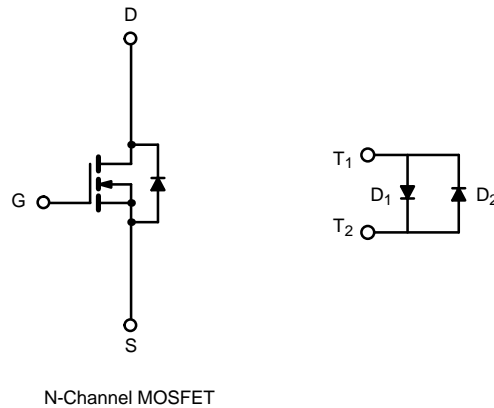
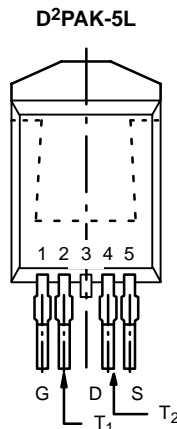

### ABSOLUTE MAXIMUM RATINGS ( $T_C = 25^\circ\text{C}$ UNLESS OTHERWISE NOTED)

Parameter	Symbol	Limit	Unit
Drain-Source Voltage	$V_{DS}$	75	V
Gate-Source Voltage	$V_{GS}$	$\pm 20$	
Continuous Drain Current ( $T_J = 175^\circ\text{C}$ ) <sup>d</sup>	$I_D$	$T_C = 25^\circ\text{C}$	60 <sup>a</sup>
		$T_C = 100^\circ\text{C}$	60 <sup>a</sup>
Pulsed Drain Current	$I_{DM}$	240	A
Continuous Diode Current (Diode Conduction) <sup>d</sup>	$I_S$	60 <sup>a</sup>	
Avalanche Current	$I_{AR}$	60 <sup>a</sup>	
Repetitive Avalanche Energy <sup>b</sup>	$E_{AR}$	180	mJ
Maximum Power Dissipation <sup>a</sup>	$P_D$	$T_C = 25^\circ\text{C}$	300 <sup>c</sup>
		$T_A = 25^\circ\text{C}$	3.75 <sup>d</sup>
Operating Junction and Storage Temperature Range	$T_J, T_{stg}$	-55 to 175	$^\circ\text{C}$

### THERMAL RESISTANCE RATINGS

Parameter	Symbol	Limit	Unit
Junction-to-Ambient <sup>d</sup>	$R_{thJA}$	40	$^\circ\text{C}/\text{W}$
Junction-to-Case	$R_{thJC}$	0.5	

#### Notes

- Package limited.
- Duty cycle  $\leq 1\%$ .
- See SOA curve for voltage derating.
- When mounted on 1" square PCB (FR-4 material).

## SUM60N08-07T



Vishay Siliconix

New Product

MOSFET SPECIFICATIONS (T <sub>J</sub> = 25°C UNLESS OTHERWISE NOTED)						
Parameter	Symbol	Test Condition	Min	Typ	Max	Unit
<b>Static</b>						
Drain-Source Breakdown Voltage	V <sub>(BR)DSS</sub>	V <sub>GS</sub> = 0 V, I <sub>D</sub> = 250 μA	75			V
Gate Threshold Voltage	V <sub>GS(th)</sub>	V <sub>DS</sub> = V <sub>GS</sub> , I <sub>DS</sub> = 250 μA	2		4	
Gate-Body Leakage	I <sub>GSS</sub>	V <sub>DS</sub> = 0 V, V <sub>GS</sub> = ±20 V			±100	nA
Zero Gate Voltage Drain Current	I <sub>DSS</sub>	V <sub>DS</sub> = 60 V, V <sub>GS</sub> = 0 V			1	μA
		V <sub>DS</sub> = 60 V, V <sub>GS</sub> = 0 V, T <sub>J</sub> = 125°C			50	
		V <sub>DS</sub> = 60 V, V <sub>GS</sub> = 0 V, T <sub>J</sub> = 175°C			500	
On-State Drain Current <sup>a</sup>	I <sub>D(on)</sub>	V <sub>DS</sub> = 5 V, V <sub>GS</sub> = 10 V	120			A
Drain-Source On-State Resistance <sup>a</sup>	r <sub>DS(on)</sub>	V <sub>GS</sub> = 10 V, I <sub>D</sub> = 25 A		0.0054	0.007	Ω
		V <sub>GS</sub> = 10 V, I <sub>D</sub> = 25 A, T <sub>J</sub> = 125°C			0.010	
		V <sub>GS</sub> = 10 V, I <sub>D</sub> = 25 A, T <sub>J</sub> = 175°C			0.013	
Sense Forward Voltage	V <sub>FD1</sub>	I <sub>F</sub> = 50 μA	710		770	mV
	V <sub>FD2</sub>	I <sub>F</sub> = 25 μA	640		700	
Sense Diode Forward Voltage Increase	ΔV <sub>F</sub>	From I <sub>F</sub> = 25 μA to I <sub>F</sub> = 50 μA	40		100	
Forward Transconductance <sup>a</sup>	g <sub>fs</sub>	V <sub>DS</sub> = 15 V, I <sub>D</sub> = 20 A		100		S
<b>Dynamic<sup>b</sup></b>						
Input Capacitance	C <sub>iss</sub>	V <sub>GS</sub> = 0 V, V <sub>DS</sub> = 25 V, f = 1 MHz		6500		pF
Output Capacitance	C <sub>oss</sub>			920		
Reverse Transfer Capacitance	C <sub>rss</sub>			400		
Total Gate Charge <sup>c</sup>	Q <sub>g</sub>	V <sub>DS</sub> = 35 V, V <sub>GS</sub> = 10 V, I <sub>D</sub> = 60 A		110	150	nC
Gate-Source Charge <sup>c</sup>	Q <sub>gs</sub>			30		
Gate-Drain Charge <sup>c</sup>	Q <sub>gd</sub>			30		
Turn-On Delay Time <sup>c</sup>	t <sub>d(on)</sub>	V <sub>DD</sub> = 35 V, R <sub>L</sub> = 0.6 Ω I <sub>D</sub> = 60 A, V <sub>GEN</sub> = 10 V, R <sub>G</sub> = 2.5 Ω		15	20	ns
Rise Time <sup>c</sup>	t <sub>r</sub>			130	200	
Turn-Off Delay Time <sup>c</sup>	t <sub>d(off)</sub>			75	115	
Fall Time <sup>c</sup>	t <sub>f</sub>			120	180	
<b>Source-Drain Diode Ratings and Characteristics (T<sub>C</sub> = 25°C)<sup>b</sup></b>						
Continuous Current	I <sub>s</sub>				60	A
Pulsed Current	I <sub>SM</sub>				240	
Forward Voltage <sup>a</sup>	V <sub>SD</sub>	I <sub>F</sub> = 60 A, V <sub>GS</sub> = 0 V		1.0	1.5	V
Reverse Recovery Time	t <sub>rr</sub>	I <sub>F</sub> = 60 A, di/dt = 100 A/μs		75	115	ns
Peak Reverse Recovery Current	I <sub>RM(REC)</sub>			3.5	5	A
Reverse Recovery Charge	Q <sub>rr</sub>			0.13	0.29	μC

## Notes:

- Pulse test; pulse width ≤ 300 μs, duty cycle ≤ 2%.
- Guaranteed by design, not subject to production testing.
- Independent of operating temperature.



**TYPICAL CHARACTERISTICS (25°C UNLESS NOTED)**

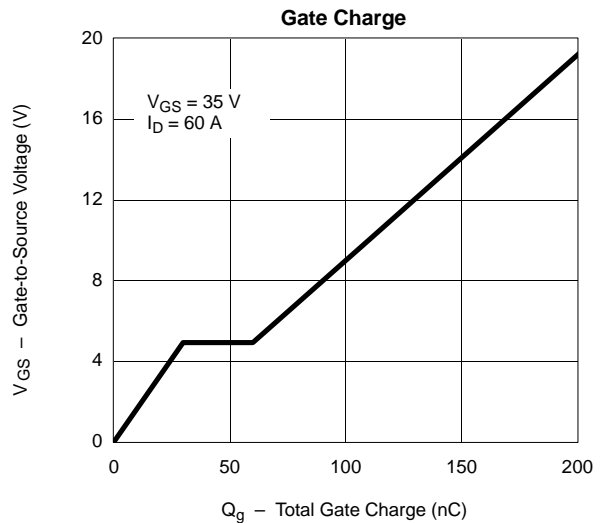
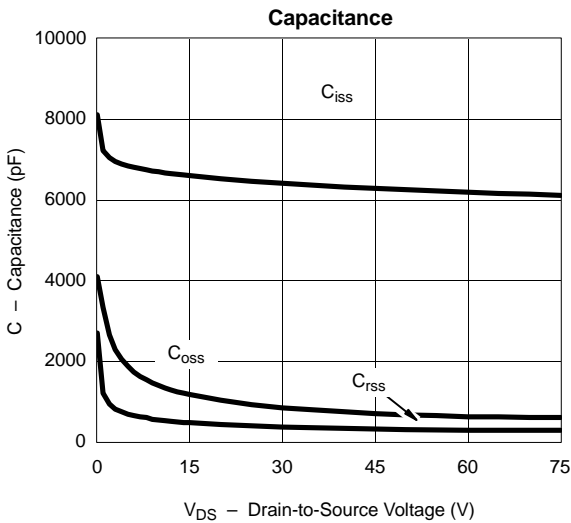
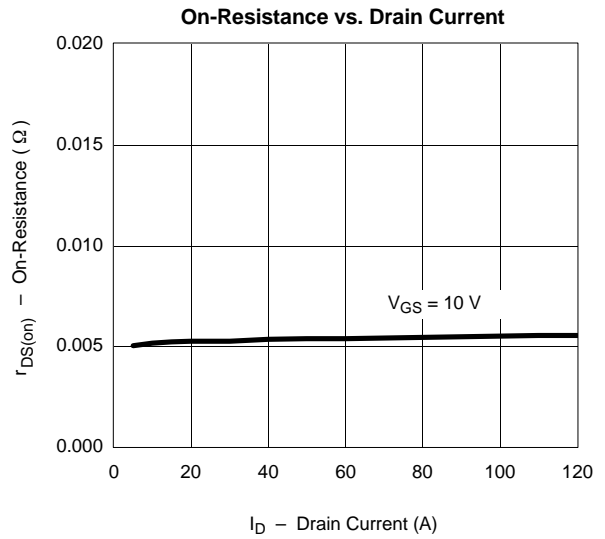
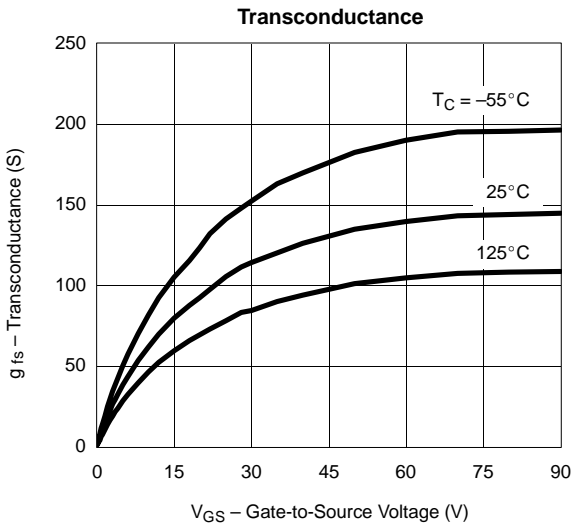
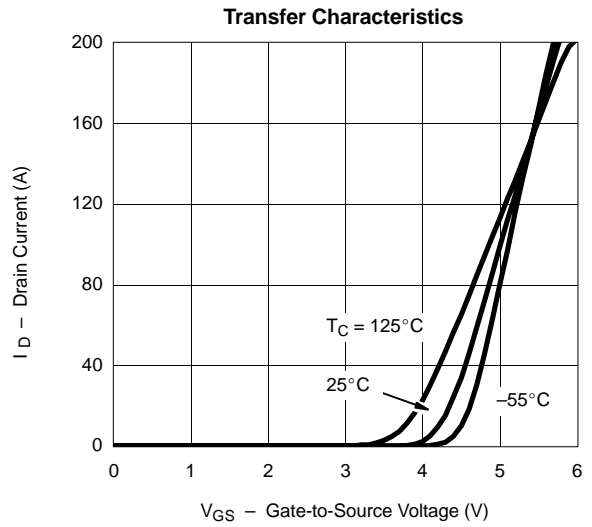
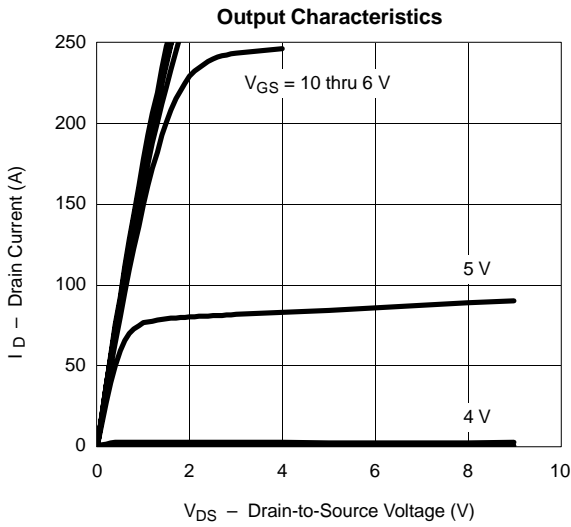

# SUM60N08-07T



Vishay Siliconix

New Product

## TYPICAL CHARACTERISTICS (25 °C UNLESS NOTED)

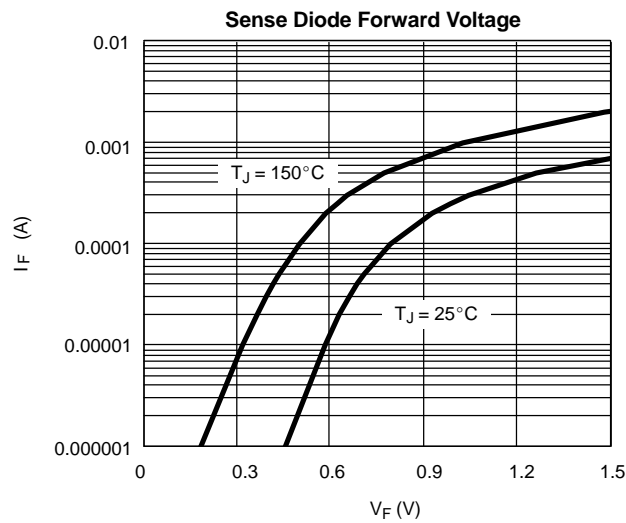
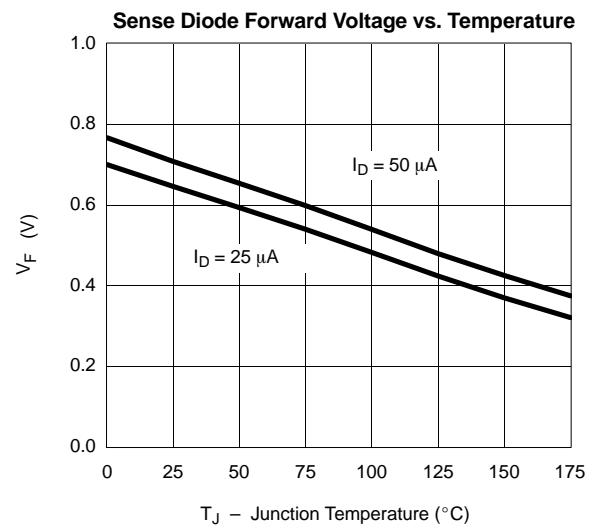
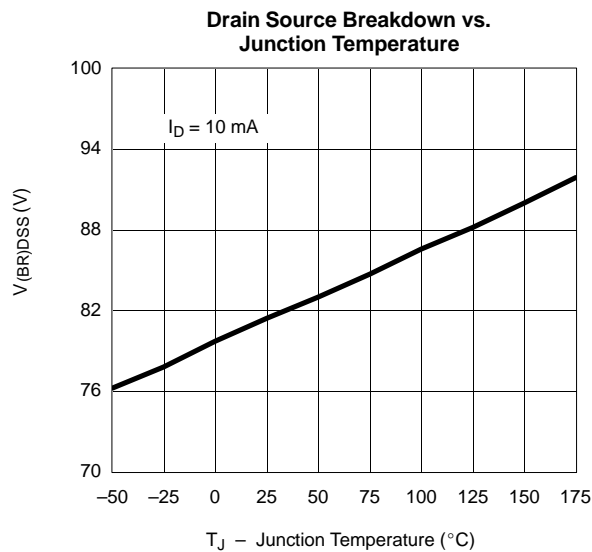
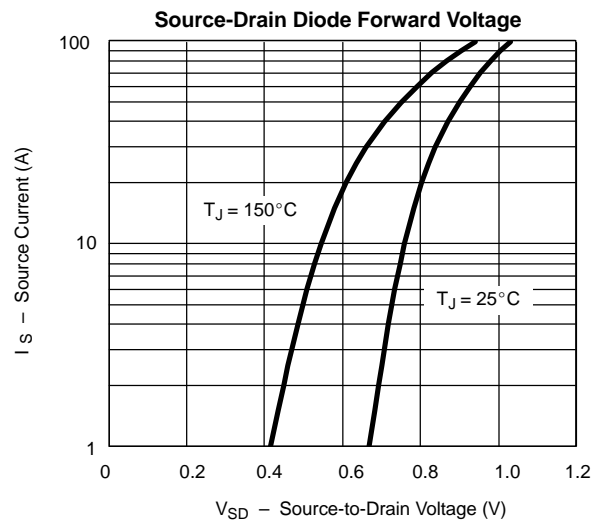
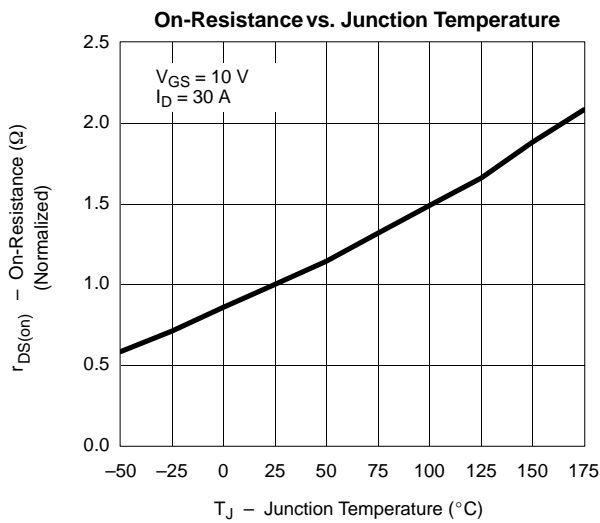



**THERMAL RATINGS**

**Maximum Avalanche and Drain Current vs. Case Temperature**

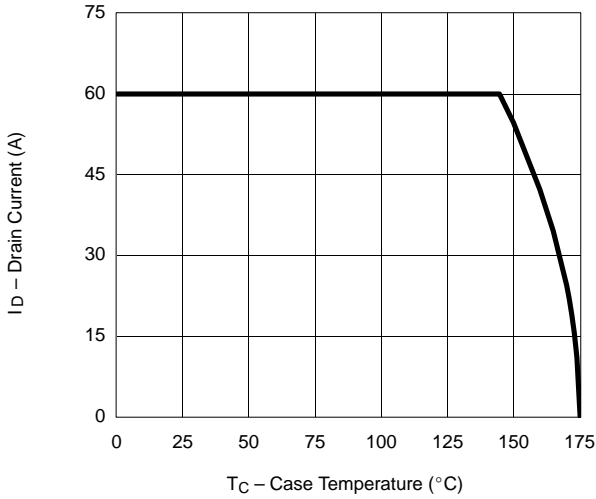

**Safe Operating Area**

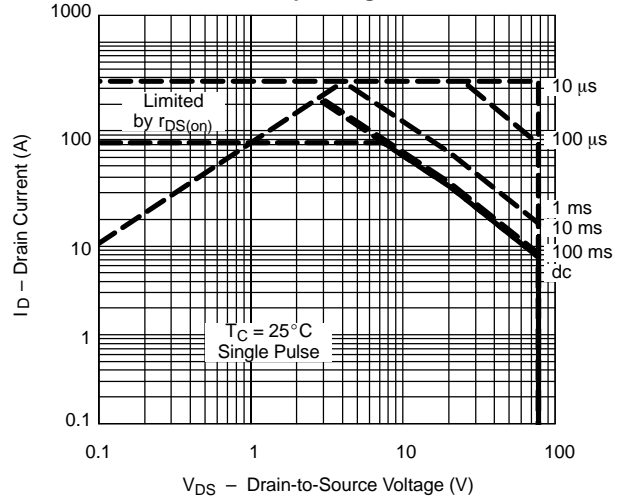

**Normalized Thermal Transient Impedance, Junction-to-Case**

