



Shanghai SVA - NEC Liquid Crystal Display Co., Ltd.

TFT COLOR LCD MODULE

(COMMON)

SVA150XG06TB

38cm (15.0 Type)

XGA

LVDS Interface (1port)

DATA SHEET

(Version 1.0)

Published by

Technology Department
SVA - NEC Liquid Crystal Display Co., Ltd.

Approved by

Date

Checked by

Date

Prepared by

Date

Signature of customer

Confirmed by

Date

INTRODUCTION

• WARRANTY

Shanghai **SVA NEC** Liquid Crystal Display Co., Ltd. (hereinafter called "SVA-NEC") warrants that this product meets the product specifications set forth in this document. If this product under normal operation is found to be non-conforming to the product specifications, and such non-conformance is promptly notified to SVA-NEC within one (1) year after the delivery date, and further such non-conformance is solely attributable to SVA-NEC, SVA-NEC shall repair the non-conforming product or replace it with a conforming one, free of charge. However, this warranty does not apply to any non-conformance that can be found easily by incoming inspections or those resulting from any one of the following:

- 1) Unauthorized or improper repair, maintenance or modification
- 2) Operation or use against specifications, instructions or warnings given by SVA-NEC
- 3) Any other causes attributable to customer

In case SVA-NEC repairs or replaces a product after the one (1)-year warranty period, SVA-NEC shall be entitled to charge for such repair or replacement. Those replaced parts shall be covered with six (6)-month warranty period from the replacement day. Non-conforming products may be replaced with substitutes instead of repair when the manufacture of this product has been terminated.

EXCEPT AS EXPRESSLY SET FORTH HEREIN, SVA-NEC DISCLAIMS ANY WARRANTIES, EXPRESS OR IMPLIED, INCLUDING BUT NOT LIMITED TO MERCHANTABILITY AND FITNESS FOR A PARTICULAR PURPOSE, AND DISCLAIMS ANY REMEDIES.

• MAINTENANCE

The specifications of maintenance parts may be partially changed within equivalent quality or better. In this product, SVA-NEC will not accept to maintain for only mounting parts on circuit board (e.g. connector, fuse, capacitor, resistor, etc.) and only backlight conformation parts (e.g. reflector sheet, light guide plate, etc.).

If SVA-NEC is planning discontinuation for this product, SVA-NEC shall inform it to customers in six (6)-months advance from the issued date of official agreements. In addition, after product discontinuation, SVA-NEC may replace substitutes instead of maintenance parts with whole product.

• CHANGE CONTROL

For the purpose of product improvement, this product design may be changed for specifications, appearance, parts, circuits and so on. In case a design change is affected on the product specifications, SVA-NEC shall inform it to customers in advance.

• HANDLING OF DOUBTFUL POINTS

Any question arising out of, or in connection with, this SPECIFICATION or any matter not stipulated herein will be settled each time upon consultation between both parties.

CONTENTS

INTRODUCTION	1
CONTENTS.....	3
1. OUTLINE	4
1.1 STRUCTURE AND PRINCIPLE.....	4
1.2 APPLICATIONS	4
1.3 FEATURES.....	4
2. GENERAL SPECIFICATIONS.....	5
3. BLOCK DIAGRAM	6
4. DETAILED SPECIFICATION	7
4.1 MECHANICAL SPECIFICATIONS.....	7
4.2 ABSOLUTE MAXIMUM RATINGS.....	7
4.3 ELECTRICAL CHARACTERISTICS	8
4.4 POWER SUPPLY VOLTAGE SEQUENCE.....	9
4.5 CONNECTIONS AND FUNCTIONS FOR INTERFACE PINS.....	10
4.6 DISPLAY COLORS AND INPUT DATA SIGNALS.....	14
4.7 DISPLAY POSITIONS.....	15
4.8 INPUT SIGNAL TIMINGS FOR LCD PANEL SIGNAL PROCESSING BOARD	15
4.9 OPTICS.....	18
4.10 DEFECT CRITERIA	20
5. RELIABILITY TESTS	24
6. ESTIMATED LUMINANCE LIFETIME	25
7. MARKINGS	26
7.1 NAMEPLATE LABEL	26
7.2 BARCODE LABEL.....	26
7.3 OTHER MARKINGS	26
7.4 INDICATION LOCATIONS	27
8. PACKING, TRANSPORTATION AND DELIVERY	28
8.1 PACKING	28
8.2 INSPECTION RECORD SHEET	28
8.3 TRANSPORTATION	28
8.4 SIZE AND WEIGHT FOR PACKING BOX.....	28
8.5 OUTLINE FIGURE FOR PACKING.....	29
9. PRECAUTIONS	31
9.1 MEANING OF CUTION SIGNS	31
9.2 CAUTIONS	31
9.3 ATTENTIONS	31
10.OUTDRAWING	33

1. OUTLINE

1.1 STRUCTURE AND PRINCIPLE

SVA150XG06TB module is composed of the amorphous silicon thin film transistor liquid crystal display (a-Si TFT LCD) panel structure with driver LSIs for driving the TFT (Thin Film Transistor) array and a backlight.

The a-Si TFT LCD panel structure is injected liquid crystal material into a narrow gap between the TFT array glass substrate and a color-filter glass substrate.

Color (Red, Green, Blue) data signals from a host system (e.g. PC, signal generator, etc.) are modulated into best form for active matrix system by a signal processing board, and sent to the driver LSIs which drive the individual TFT arrays.

The TFT array as an electro-optical switch regulates the amount of transmitted light from the backlight assembly, when it is controlled by data signals. Color images are created by regulating the amount of transmitted light through the TFT array of red, green and blue dots.

1.2 APPLICATIONS

- Monitor for PC

1.3 FEATURES

- a-Si TFT active matrix
- LVDS interface (8 bit)
- Selectable LVDS input map
- Wide viewing angle
- high response time : 16ms
- PSWG standard
- High contrast: 450:1
- Edge light type backlight (Inverter less)
- Replaceable lamp for backlight

2. GENERAL SPECIFICATIONS

Display area	304.128 (W) x 228.096 (H) mm (typ.)
Diagonal size of display	38.0 cm (15.0 inches)
Drive system	a-Si TFT active matrix
Display color	16,777,216 colors (6bit+FRC)
Pixel	1,024 (H) x 768 (V) pixels
Pixel arrangement	RGB (Red dot、Green dot、Blue dot) vertical stripe
Dot pitch	0.099 (W) x 0.297 (H) mm
Pixel pitch	0.297 (W) x 0.297 (H) mm
Module size	326.50 (W) x 253.5 (H) x 11.2 (D) mm (typ.)
Weight	1000 g (typ.)
Contrast ratio	450:1 (typ.)
Viewing angle (At the contrast ratio 10: 1)	<ul style="list-style-type: none"> • Horizontal: 120° (typ.) • Vertical: 100° (typ.)
Designed viewing direction	• Viewing angle with optimum grayscale ($\gamma = 2.2$): normal axis
Color gamut	At LCD panel center 60 % (typ.) [against NTSC color space]
Response time	T_{on} (white 90% \rightarrow black 10%) + T_{off} (black 10% \rightarrow white 90%) 16 ms (typ.)
Luminance	At $IBL = 7.5mArms / lamp$ 250cd/m ² (typ.)
Signal system	LVDS 1port [RGB :8-bit, Dot clock (CLK), Data enable (DE)]
Power supply voltage	LCD panel signal processing board: 3.3V
Backlight	Edge light type: 2 cold cathode fluorescent lamps } Replaceable part <ul style="list-style-type: none"> • Lamp holder set: Type No. 150LHS21
Power consumption	At $IBL=7.5mArms / lamp$ and checkered flag pattern 9.5W (typ.)

3. BLOCK DIAGRAM

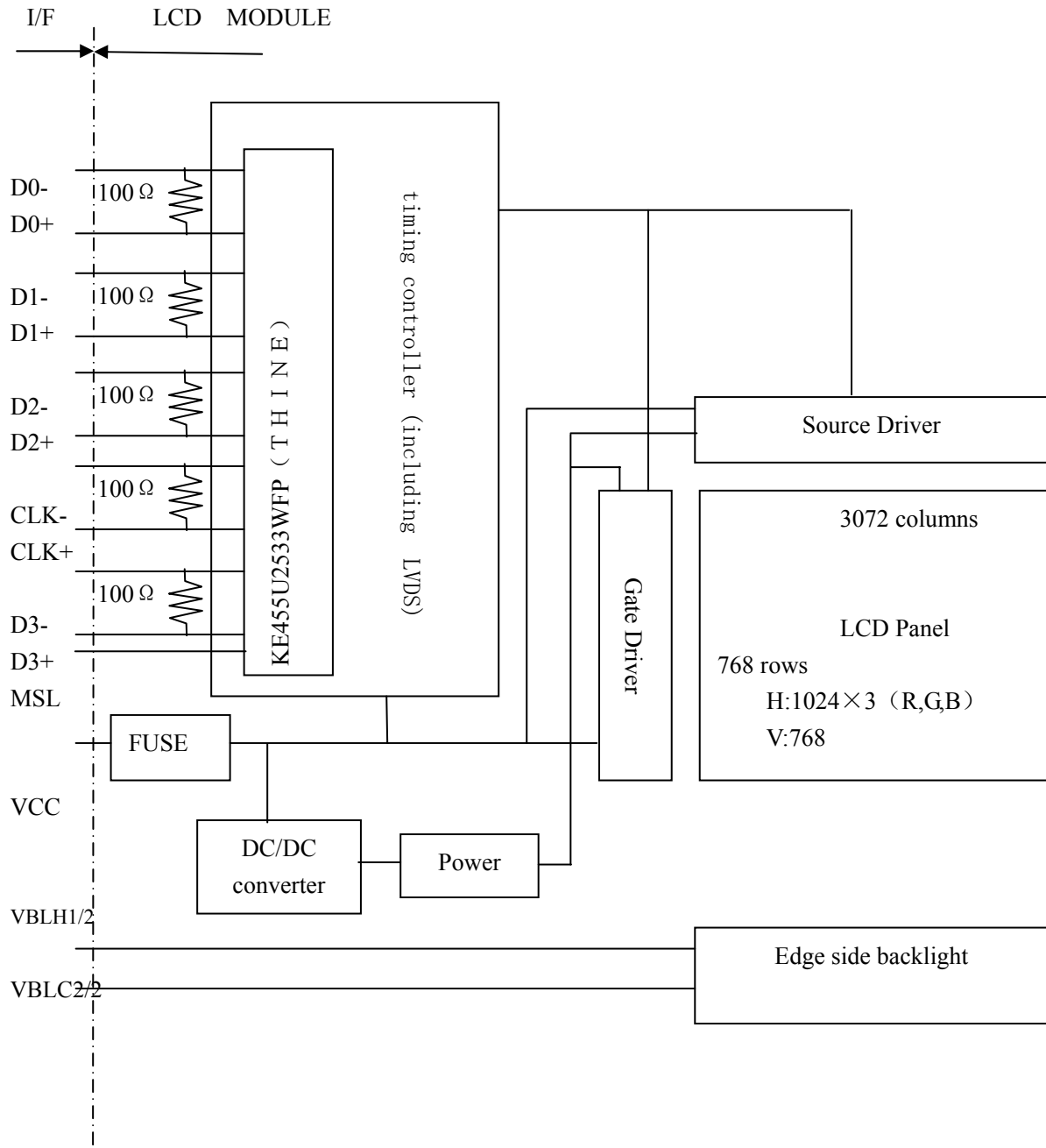

Note1: Connections between GND, FG (Frame ground) and VBLC (Lamp low voltage terminal) in the product

GND - FG	Connected
GND - VBLC	Not connected
FG - VBLC	Not connected

Note2: These grounds should be connected together in customer equipment.

4. DETAILED SPECIFICATION

4.1 MECHANICAL SPECIFICATIONS

Parameter	Specification	Unit
Module size	326.5± 0.5 (W) x 253.5 ± 0.5 (H) x 11.2 ± 0.5 (D) Note1	mm
Display area	304.128 (W) x 228.096 (H) Note1	mm
Weight	1000 (typ.)	g

Note1: See “10. OUTLINE DRAWINGS”.

4.2 ABSOLUTE MAXIMUM RATINGS

Parameter		Symbol	Rating	Unit	Remarks
Power supply voltage	LCD panel signal board	VCC	-0.3 to +3.6	V	Ta = 25°C
Input voltage for signals	Display signals Note1	Vi	-0.3 to +3.6 and Vi < VCC + 0.3	V	Ta = 25°C
	Function signals Note2				
Storage temperature		Tst	-20 to +60	°C	-
Operating temperature	Front surface	TopF	0 to +50	°C	Note3
	Rear surface	TopR	0 to +55	°C	Note4
Relative humidity Note5		RH	≤ 95	%	Ta ≤ 40°C
			≤ 85	%	40 < Ta ≤ 50°C
Absolute humidity Note6		AH	≤ 70 Note6	g/m ³	Ta > 50°C

Note1: Display signals are D0+/-, D1+/-, D2+/-, D3+/- and CK+/-.

Note2: Function signal is MSL.

Note3: Measured at center of LCD panel surface (including self-heat)

Note4: Measured at center of LCD module's rear shield surface (including self-heat)

Note5: No condensation

Note6: Ta = 50°C, RH = 85%

4.3 ELECTRICAL CHARACTERISTICS

4.3.1 Driving for LCD panel signal processing board

Parameter		Symbol	min.	typ.	max.	Unit	Remarks
Power supply voltage		VCC	3.0	3.3	3.6	V	-
Power supply current		ICC	-	330※1	600※2	mA	at VCC = 3.3V
Permissible ripple voltage		VRP	-	-	100	mV	For VCC
Differential input threshold voltage for LVDS receiver	Low	VTL	-100	-		mV	at VCM = 1.2V Note3
	High	VTH	-	-	100	mV	
Input voltage width for LVDS receiver		Vi	0	-	2.4	V	-
Terminating resistor		RT	-	100	-	Ω	-
Input voltage for MSL signal	Low	VFL	0	-	0.8	V	-
	High	VFH	2.0	-	VCC	V	

※1: Checkered flag pattern (EIAJ ED-2522);

※2: 2H1V dot inverse pattern

※3: Common mode voltage for LVDS receiver

4.3.2 Driving for backlight lamp

Parameter	Symbol	min.	typ.	max.	Unit	Remarks
Lamp current	I _L	3.5	7.5	8.0	mArms	at L = 250cd/ m ² (typ.)
Lamp voltage	V _L	-	560	-	Vrms	For each lamp
Lamp starting voltage Note1	V _S	1500	-	-	Vrms	Ta = 0°C Note2
		1300	-	-	Vrms	Ta = 25°C Note2
Oscillation frequency	FO	50	55	60	kHz	Note3

Note1: The value is the characteristic of lamp. The starting voltage of inverter should be lower than the value. But the possibility of not lighting exists by the lower voltage, so the suitable voltage should be considered by the test.

Note2: The asymmetric ratio of working waveform for lamps (Lamp voltage peak ratio, Lamp current peak ratio and waveform space ratio) should be less than 5% (See the following figure). If the waveform is asymmetric, DC (Direct current) element applies into the lamp. In this case, a lamp lifetime may be shortened, because a distribution of a lamp enclosure substance inclines toward one side between low voltage terminal (Cold terminal) and high voltage terminal (Hot terminal).

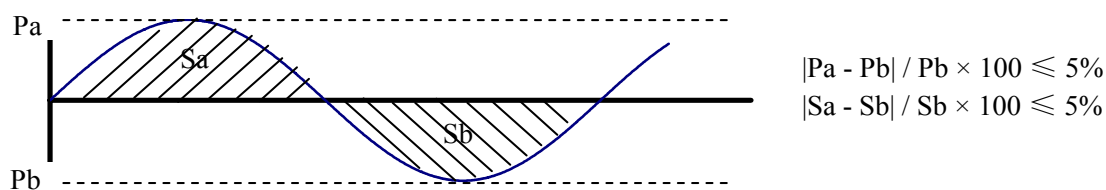

Pa: Supply voltage/current peak for positive, Pb: Supply voltage/current peak for negative

Sa: Waveform space for positive part, Sb: Waveform space for negative part

Note3: Recommended value of "FO" is as following.

$$FO = 1/4 \times 1/\text{th} \times (2n-1) \quad n: \text{Natural number } (1, 2, 3, \dots)$$

but there might be noise on the display image.

Parameter	Power supply voltage	Ripple voltage (Measured at input terminal of power supply)	Note1	Unit
VCC	3.3 V	≤ 100		mVp-p

Note1: The permissible ripple voltage includes spike noise.

4.4.3 Fuse

Parameter	Fuse		Rating	Fusing current	Remarks
	Type	Supplier			
VCC	TF16SN2.50	KOA Corporation	2.5 A	5.0 A	Note1
			32 V		

Note1: The power supply capacity should be more than the fusing current. If the power supply capacity is less than the fusing current, the fuse may not blow for a short time, and then nasty smell, smoking and so on may occur.

4.5 CONNECTIONS AND FUNCTIONS FOR INTERFACE PINS

4.5.1 LCD panel signal processing board

CN1 socket(Module side): DF-14H-20P-1.25H (Hirose Electric Co., Ltd.)

Adaptable plug: DF14-20S-1.25C (Hirose Electric Co., Ltd.)

Pin No.	Symbol	Signal	Remarks
1	VCC	Power supply	-
2	VCC		
3	GND	Ground	-
4	GND		
5	D0-	Pixel data	Note2
6	D0+		
7	GND	Ground	-
8	D1-	Pixel data	Note2
9	D1+		
10	GND	Ground	-
11	D2-	Pixel data	Note2
12	D2+		
13	GND	Ground	-
14	CLK-	Pixel clock	Note2
15	CLK+		
16	GND	Ground	-
17	D3-	Pixel data	Note2
18	D3+		
19	GND	Ground	-
20	MSL	Selection of LVDS input Map Note1	High: Input map A mode Low or Open: Input map B mode

Note1: See“4.5.4 Connection between receiver and transmitter For LVDS” .

Note2: Twist pair wires with 100Ω(Characteristic impedance) should be connected between LCD panel signal processing board and LVDS transmitter.

4.5.2 Backlight lamp

Attention: VBLH and VBLC must be connected correctly. IF customer connects wrongly, customer will be hurt and the product will be broken.

CN201 plug (LCD module side): BHR-03VS-1 (J.S.T Mfg. Co., Ltd.)

Adaptable socket: SM02 (8.0) B-BHS-1-TB (J.S.T Mfg. Co., Ltd.)

Pin No.	Symbol	signal	remarks
1	VBLH	High voltage terminal(Hot)	Cable color: (Sky)Blue
2	N.C	-	-
3	VBLC	Low voltage terminal(Cold)	Cable color: White

CN202 plug (LCD module side): BHR-03VS-1 (J.S.T Mfg. Co., Ltd.)

Adaptable socket: SM02 (8.0) B-BHS-1-TB (J.S.T Mfg. Co., Ltd.)

Pin No.	Symbol	signal	remarks
1	VBLH	High voltage terminal(Hot)	Cable color: (Sky)Blue
2	N.C	-	-
3	VBLC	Low voltage terminal(Cold)	Cable color: White

4.5.3 Position of plugs and a socket

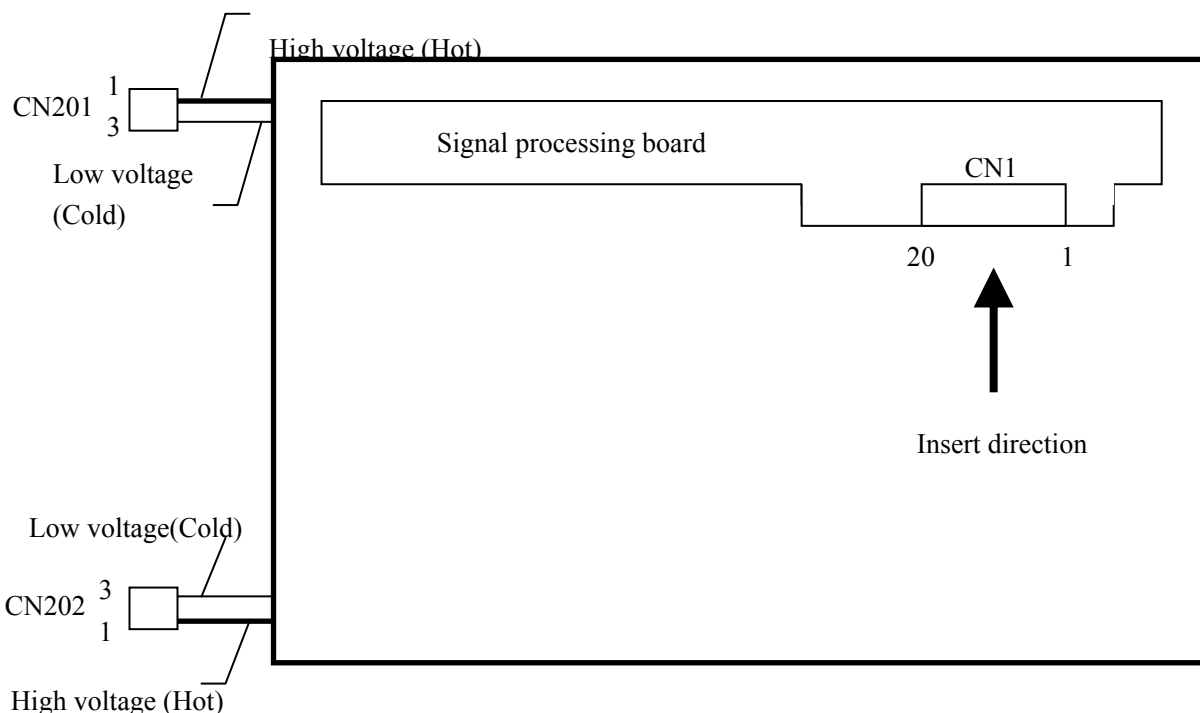

4.5.4 Connection between receiver and transmitter for LVDS

(2) Input LVDS map B(MSL : "Low" or "Open")

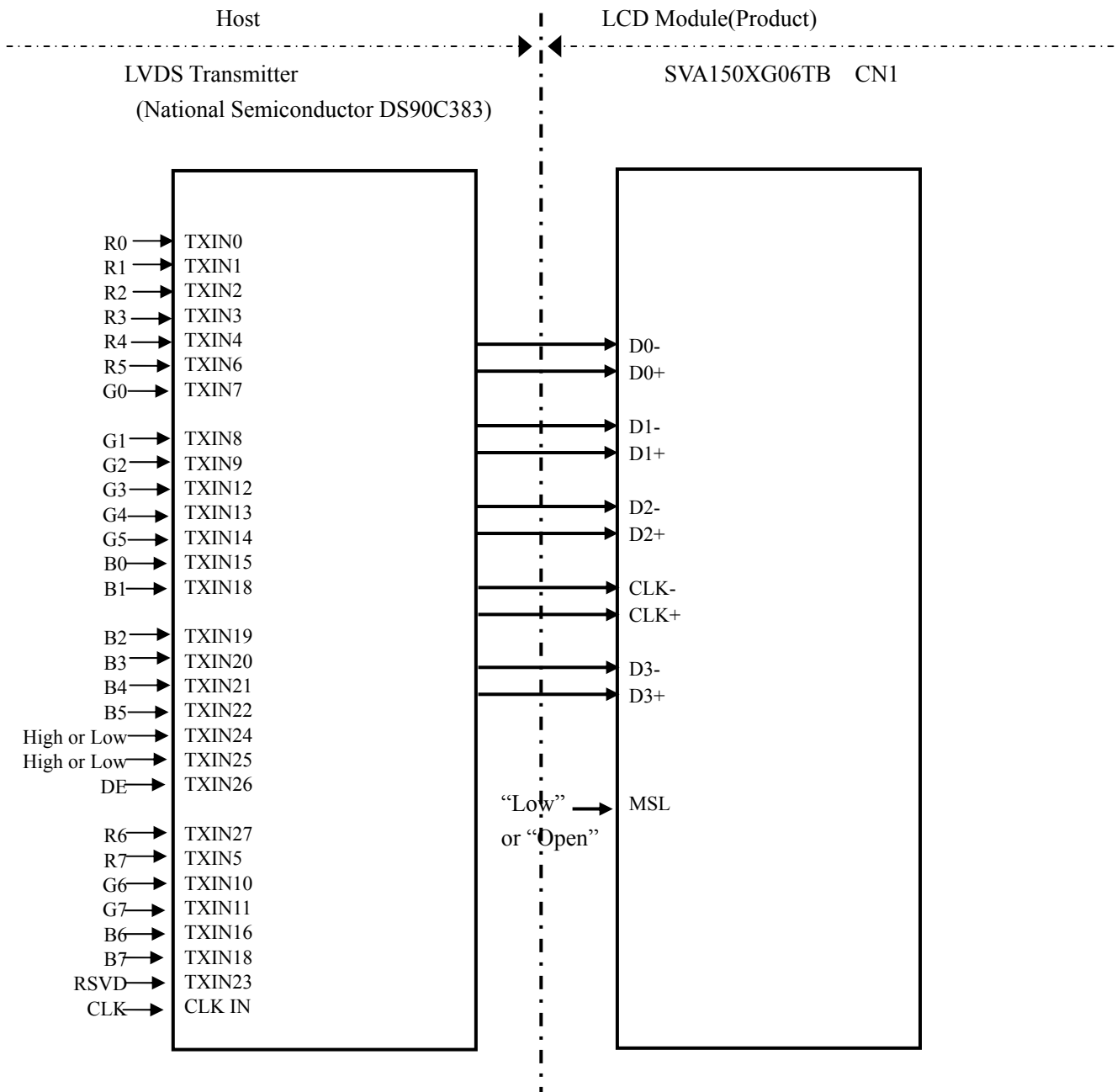

Note1: Recommended transmitter

See the data sheet for DS90C383 (National Semiconductor) .

Note2: LSB (Least Significant Bit) -R0,G0,B0 MSB (Most Significant Bit) -R7,G7,B7

4.6 DISPLAY COLORS AND INPUT DATA SIGNALS

This product can display in equivalent to 16,777,216 colors in 256 scale. Also the relation between display colors and input data signals is as the following table.

Display colors		Data signal (0:Low level, 1:High Level)																							
		R7	R6	R5	R4	R3	R2	R1	R0	G7	G6	G5	G4	G3	G2	G1	G0	B7	B6	B5	B4	B3	B2	B1	B0
Basic Color	Black	0	0	0	0	0	0	0	0	0	0	0	0	0	0	0	0	0	0	0	0	0	0	0	0
	Blue	0	0	0	0	0	0	0	0	0	0	0	0	0	0	0	0	1	1	1	1	1	1	1	1
	Red	1	1	1	1	1	1	1	1	0	0	0	0	0	0	0	0	0	0	0	0	0	0	0	0
	Magenta	1	1	1	1	1	1	1	1	0	0	0	0	0	0	0	0	1	1	1	1	1	1	1	1
	Green	0	0	0	0	0	0	0	0	1	1	1	1	1	1	1	1	0	0	0	0	0	0	0	0
	Cyan	0	0	0	0	0	0	0	0	1	1	1	1	1	1	1	1	1	1	1	1	1	1	1	1
	Yellow	1	1	1	1	1	1	1	1	1	1	1	1	1	1	1	1	0	0	0	0	0	0	0	0
	White	1	1	1	1	1	1	1	1	1	1	1	1	1	1	1	1	1	1	1	1	1	1	1	1
Red grayscale	Black	0	0	0	0	0	0	0	0	0	0	0	0	0	0	0	0	0	0	0	0	0	0	0	0
		0	0	0	0	0	0	0	1	0	0	0	0	0	0	0	0	0	0	0	0	0	0	0	0
	Dark ↑	0	0	0	0	0	0	1	0	0	0	0	0	0	0	0	0	0	0	0	0	0	0	0	0
						:								:								:			
	↓					:								:								:			
	Bright	1	1	1	1	1	1	0	1	0	0	0	0	0	0	0	0	0	0	0	0	0	0	0	0
Red	1	1	1	1	1	1	1	0	0	0	0	0	0	0	0	0	0	0	0	0	0	0	0	0	
	1	1	1	1	1	1	1	1	0	0	0	0	0	0	0	0	0	0	0	0	0	0	0	0	
Green grayscale	Black	0	0	0	0	0	0	0	0	0	0	0	0	0	0	0	0	0	0	0	0	0	0	0	0
		0	0	0	0	0	0	0	0	0	0	0	0	0	0	0	1	0	0	0	0	0	0	0	0
	Dark ↑	0	0	0	0	0	0	0	0	0	0	0	0	0	0	1	0	0	0	0	0	0	0	0	0
						:								:								:			
	↓					:								:								:			
	Bright	0	0	0	0	0	0	0	0	1	1	1	1	1	1	0	1	0	0	0	0	0	0	0	0
Green	0	0	0	0	0	0	0	0	1	1	1	1	1	1	1	0	0	0	0	0	0	0	0	0	
	0	0	0	0	0	0	0	0	1	1	1	1	1	1	1	1	0	0	0	0	0	0	0	0	
Blue grayscale	Black	0	0	0	0	0	0	0	0	0	0	0	0	0	0	0	0	0	0	0	0	0	0	0	0
		0	0	0	0	0	0	0	0	0	0	0	0	0	0	0	0	0	0	0	0	0	0	0	1
	Dark ↑	0	0	0	0	0	0	0	0	0	0	0	0	0	0	0	0	0	0	0	0	0	0	1	0
						:								:								:			
	↓					:								:								:			
	Bright	0	0	0	0	0	0	0	0	0	0	0	0	0	0	0	0	1	1	1	1	1	1	0	1
Blue	0	0	0	0	0	0	0	0	0	0	0	0	0	0	0	0	1	1	1	1	1	1	1	0	
	0	0	0	0	0	0	0	0	0	0	0	0	0	0	0	0	1	1	1	1	1	1	1	1	

4.7 DISPLAY POSITIONS

The following table is the coordinates per pixel.

C (1, 1)									
<table border="1" style="margin: auto;"> <tr> <td style="padding: 2px;">R</td> <td style="padding: 2px;">G</td> <td style="padding: 2px;">B</td> </tr> </table>							R	G	B
R	G	B							
C (1, 1)	C (2, 1)	...	C (X, 1)	...	C (1023, 1)	C (1024, 1)			
C (1, 2)	C (2, 2)	...	C (X, Y)	...	C (1023, 2)	C (1024, 2)			
•	•	•	•	•	•	•			
•	•	•••	•	•••	•	•			
•	•	•	•	•	•	•			
C (1, Y)	C (2, Y)	...	C (X, Y)	...	C (1023, Y)	C (1024, Y)			
•	•	•	•	•	•	•			
•	•	•••	•	•••	•	•			
•	•	•	•	•	•	•			
C (1, 767)	C (2, 767)	...	C (X, 767)	...	C (1023, 767)	C (1024, 767)			
C (1, 768)	C (2, 768)	...	C (X, 768)	...	C (1023, 767)	C (1024, 768)			

4.8 INPUT SIGNAL TIMINGS FOR LCD PANEL SIGNAL PROCESSING BOARD

4.8.1 Outline of input signal timings

• Horizontal signal

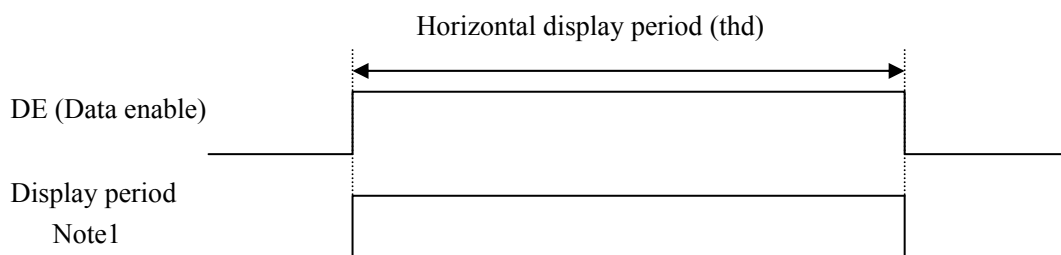

Note1: This diagram indicates virtual signal for set up to timing.

• Vertical signal

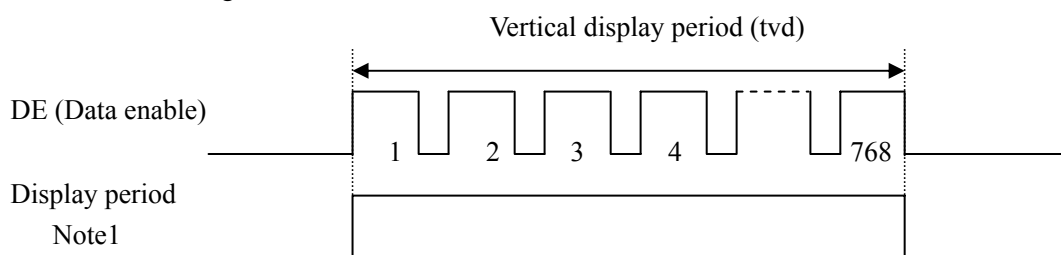

Note1: This diagram indicates virtual signal for set up to timing.

4.8.2 Timing characteristics

(Note1)

Parameter		Symbol	min.	typ.	max.	Unit	Remarks	
CLK	Frequency	1/tc	60.0	65.0	70.0	MHz	15.384ns (typ.)	
	Duty	—	—			—	Note2	
	Rise time, Fall time	—	—			ns		
DATA	CLK-DATA	Setup time	—	—			ns	Note2
		Hold time	—	—			ns	
	Rise time, Fall time	—	—			ns		
DE	Horizontal	Cycle	th	12.3	20.676	30.00	μs	48.363KHz(typ.)
				1050	1344	1800	CLK	Note3 Note4
		Display period	thd	1024				—
	Vertical (One frame)	Cycle	tv	13.1	16.666	20.0	ms	60.0Hz (typ.)
				770	806	1334	H	
		Display period	tvd	768			H	
	CLK-DE	Setup time	—	—			ns	
		Hold time	—	—			ns	
Rise time, Fall time	—	—			ns			

Note1: Definition of parameters is follows.

$$tc=1CLK, Th=1H$$

Note 2: See the data sheet of LVDS transmitter.

Note 3: Both of “time” and “CLK number” of the “th” must keep the Minimum value of specifications.

Note 4: “th” must keep the fluctuation within ± 1 CLK, because of avoidance of image sticking.

4.8.3 Input signal timing chart

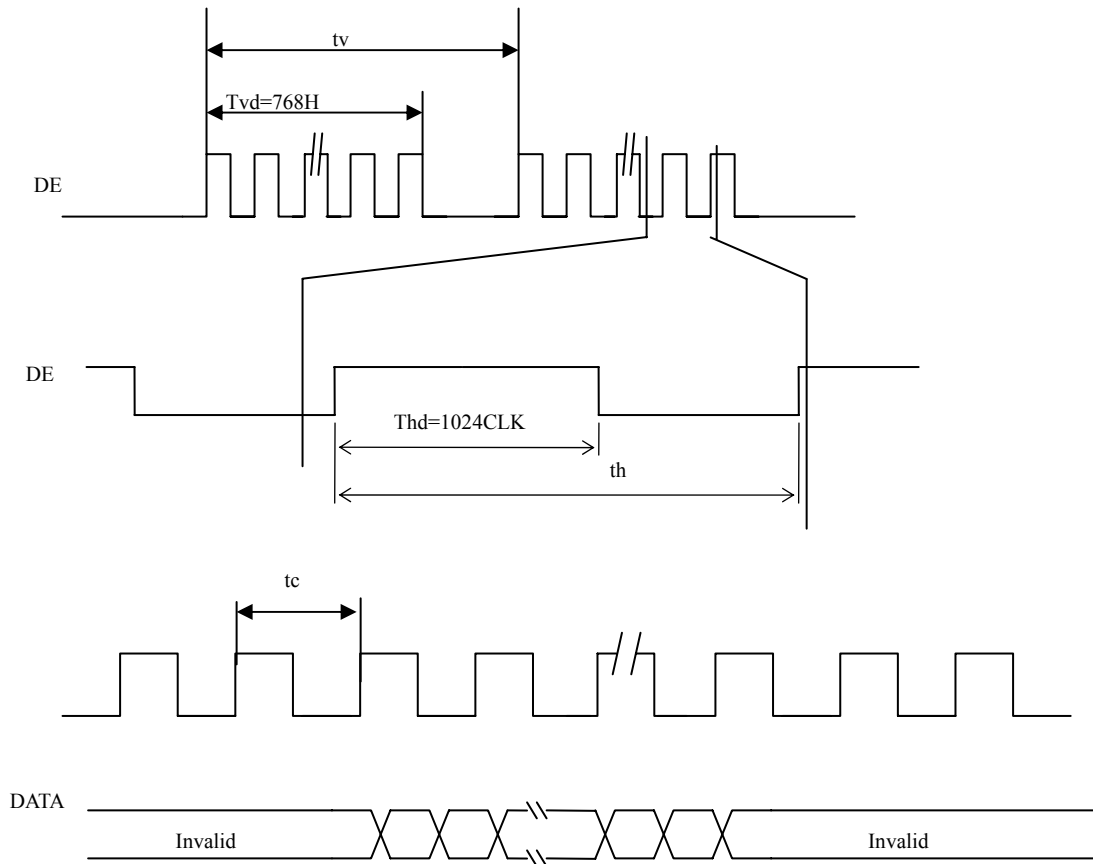

4.9 OPTICS

4.9.1 Optical characteristics

Parameter Note1	Condition	Symbol	min.	typ.	max.	Unit	
Luminance	White at center R=0, L=0, U=0,D=0	L	200	250	-	cd/ m ²	
Contrast ratio	White/Black at center R=0, L=0, U=0,D=0	CR	350	450	-	-	
Luminance uniformity	-	LU	-	1.2	1.3	-	
Chromaticity	White	X coordinate	Wx	0.283	0.313	0.343	-
		Y coordinate	Wy	0.299	0.329	0.359	-
	Red	X coordinate	Rx	-	0.63	-	-
		Y coordinate	Ry	-	0.35	-	-
	Green	X coordinate	Gx	-	0.30	-	-
		Y coordinate	Gy	-	0.59	-	-
	Blue	X coordinate	Bx	-	0.14	-	-
		Y coordinate	By	-	0.09	-	-
Color gamut	R=0, L=0, U=0,D=0	C	50	60	-	%	
Response time	White to black	Ton	-	4	7	ms	
	Black to white	Toff	-	12	18	ms	
Viewing angle	Right	$\theta U=0^\circ, \theta D=0^\circ, CR=10$	θR	50	60	-	°
	Left	$\theta U=0^\circ, \theta D=0^\circ, CR=10$	θL	50	60	-	°
	Up	$\theta R=0^\circ, \theta L=0^\circ, CR=10$	θU	30	40	-	°
	Down	$\theta R=0^\circ, \theta L=0^\circ, CR=10$	θD	35	60	-	°

Note1: Measurement conditions are follows.

Ta=25C, VCC=3.3V, IBL=7.5mArms/lamp, Display mode: XGA, Horizontal cycle=48.363 KHZ, Vertical cycle=60.000Hz

Optical characteristics are measured at luminance saturation after 20minutes from working the product, in the dark room. Also measurement method for luminance is as follows.

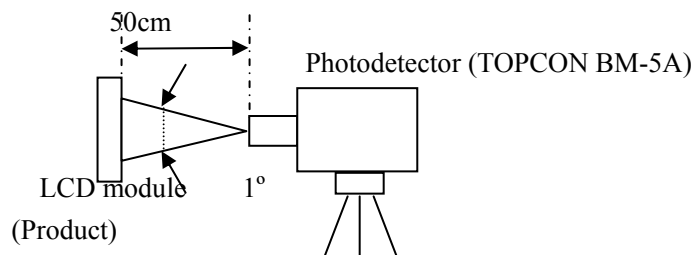

Note 2: See“4.10.2 Definition of contrast ratio”.

Note 3: See“4.10.3 Definition of luminance uniformity”.

Note 4: Product surface temperature: TopF=28.0°C

Note 5: See “4.10.4 Definition of response times”.

Note 6: See “4.10.5 Definition of viewing angles”.

4.9.2 Definition of contrast ratio

The contrast ratio is calculated by using the following formula.

$$\text{Contrast ratio (CR)} = \frac{\text{Luminance of white screen}}{\text{Luminance of black screen}}$$

4.9.3 Definition of luminance uniformity

The luminance uniformity is calculated by using the following formula.

$$\text{Luminance uniformity (LU)} = \frac{\text{Maximum luminance from ① to ⑤}}{\text{Minimum luminance from ① to ⑤}}$$

The luminance is measured at near the 5 points shown below.

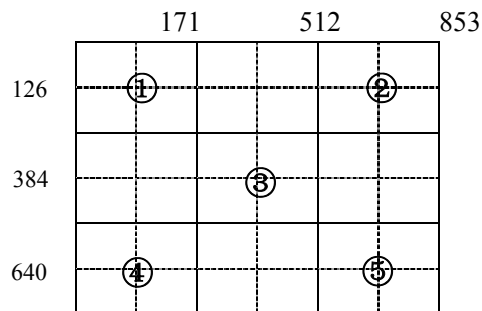

4.9.4 Definition of response times

Response time is measured, the luminance changes from “white” to “black”, or “black” to “white” on the same screen point, by photo-detector. Ton is the time it takes the luminance change from 90% down to 10%. Also Toff is the time it takes the luminance change from 10% up to 90%. (See the following diagram.)

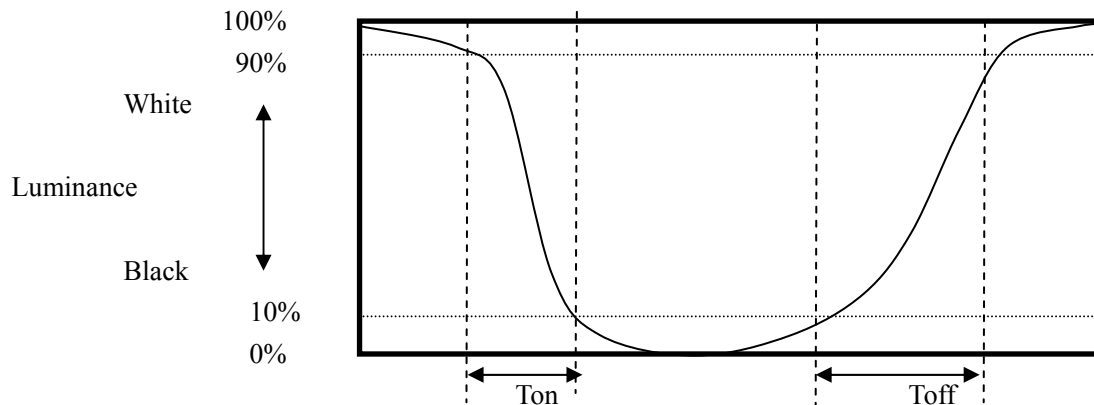

4.9.5 Definition of viewing angles

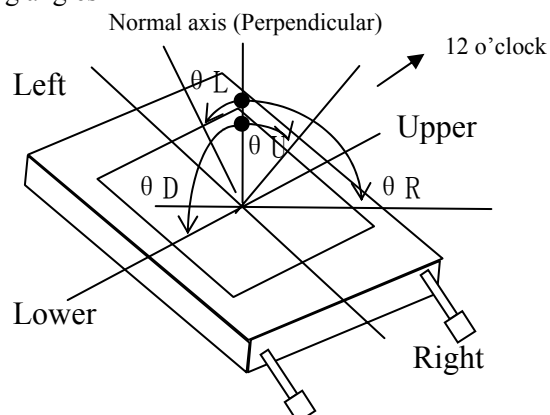

4.10 DEFECT CRITERIA

4.10.1 Display specification

(Note1, Note 2)

Defect pattern	Condition		Criteria	
Line defect	Display of black, white, red, green, blue		0 line	
Bright dots Note 2 Note 3	R+G+B		≤ 3 dots	
	Close defect dots Note 6	$15\text{mm} \leq \mathbf{D}$ Note 5	Allowed	
	Linked defect dots Note 7	$\mathbf{D}=0\text{mm}$ Note 5	2 defect dots	≤ 1 set
			3 defect dots or more	0 set
Dark dots Note 2 Note 4	R+G+B		≤ 3 dots	
	Close defect dots Note 6	$15\text{mm} \leq \mathbf{D}$ Note 5	Allowed	
	Linked defect dots Note 7	$\mathbf{D}=0\text{mm}$ Note 5	2 defect dots	≤ 1 set
			3 defect dots or more	0 set
Total	Bright dots + Dark dots		≤ 5 dots	

Note 1: Inspection conditions are as follows.

Temperature	$25 \pm 5^\circ\text{C}$
Inspection viewing distance	20cm(The distance between the inspector's eye and screen)
Inspection direction	$0^\circ \leq \theta_R \leq 20^\circ, 0^\circ \leq \theta_L \leq 20^\circ$
	$0^\circ \leq \theta_U \leq 20^\circ$
Inspection illumination	60lx(at a display surface)

Note 2: Defect area $> 1/2$ of one dot

Dot defects are include intermittent bright and dark dot.

Dots darker than half brightness of full bright dots are not defined as bright dot defect, and dots brighter than half brightness of full bright dots are not defined as dark dot defect.

Note 3: Bright dots are counted while the display is black.



Note 4: Dark dots are counted while the display is illuminated with Red, Green or Blue.

Note 5: \mathbf{D} is the distance between defect dots.



Note 6: See“4.10.2 Close defect dots”.

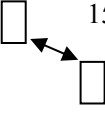
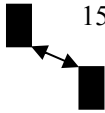
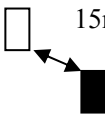

Note 7: See“4.10.3 Linked defect dots”.

4.10.2 Close defect dots

Defect pattern	 : Bright dot  : Dark dot	Criteria
Bright dots	 $15\text{mm} \leq \mathbf{D}$	Allowed
Dark dots	 $15\text{mm} \leq \mathbf{D}$	Allowed
Combinations between bright dot and dark dot	 $15\text{mm} \leq \mathbf{D}$	Allowed

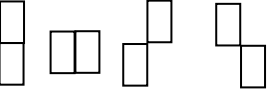
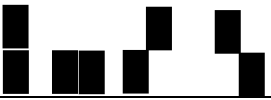
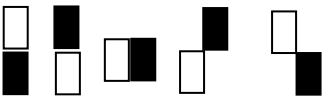
4.10.3 Linked defect dots

Defect pattern	 : Bright dot  : Dark dot	Criteria
2 defect dots		≤ 1 set
		≤ 1 set
	Combination between bright dots and dark dot  Etc.	≤ 2 sets

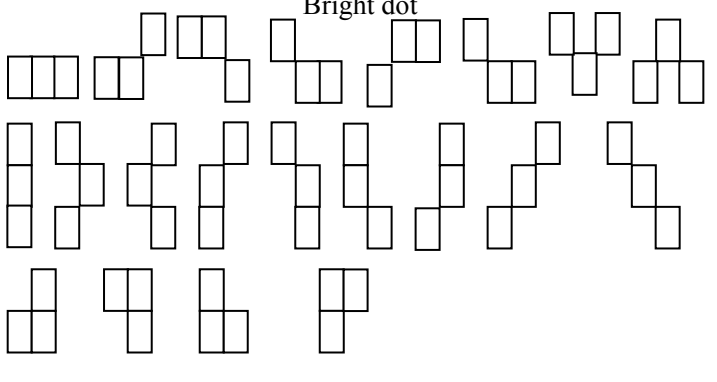
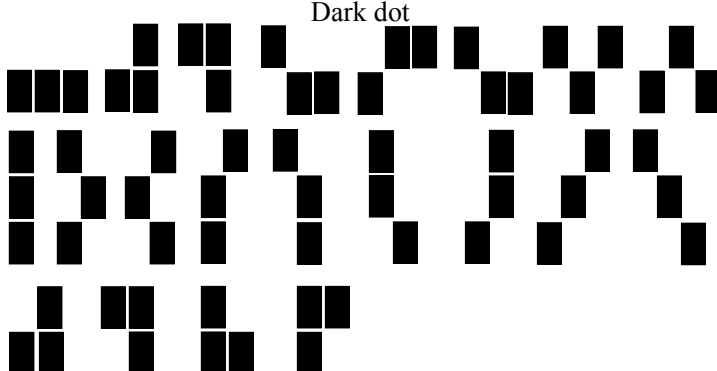
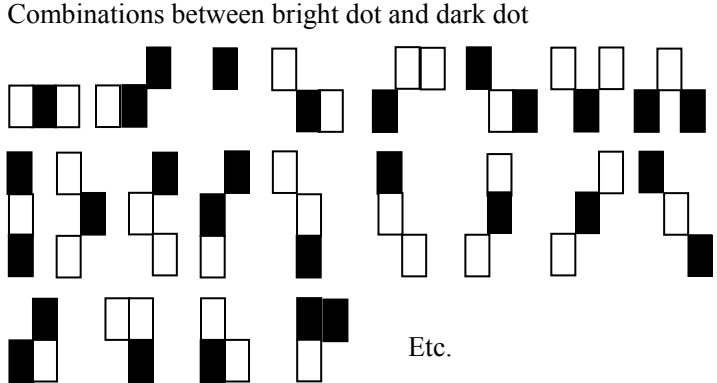
Defect pattern	 : Bright dot  : Dark dot	Criteria
3 defect dots	<p>Bright dot</p> 	0 set
	<p>Dark dot</p> 	
	<p>Combinations between bright dot and dark dot</p>  <p>Etc.</p>	Allowed

4.10.4 Appearance specifications

Defect pattern		Condition	Note 1	Criteria
Impure ingredient Stains Dust	Dot shape	$d < 0.2\text{mm}$		Allowed
		$0.2\text{mm} \leq d < 0.3\text{mm}$		≤ 10 points
		$0.3\text{mm} \leq d \leq 0.5\text{mm}$		≤ 3 points
		$d > 0.5\text{mm}$		0 point
		Adjacent other objects		
	Line shape	$W < 0.05\text{mm}$		Allowed
		$0.05\text{mm} \leq W \leq 0.1\text{mm}$	$L < 0.7\text{mm}$	≤ 4 points
			$0.7\text{mm} \leq L \leq 1.0\text{mm}$	
			$L > 1.0\text{mm}$	0 point
	$W > 0.1\text{mm}$			
Bubbles, Wrinkles, Dent	$d \leq 0.2\text{mm}$		Allowed	
	$0.2\text{mm} < d \leq 0.5\text{mm}$		≤ 2 points	
	$d > 0.5\text{mm}$		0 point	
Polarizer scratch	$S \leq 0.2\text{mm}^2$		Allowed	
	$S > 0.2\text{mm}^2$		0 point	
Flick	Refer to limited samples			
Mura	Refer to limited samples			
Crosstalk	Refer to limited samples			

Note1: Definition of symbols is as follows.

d: Average diameter

(This diameter is the average length of a long axis and a short axis in each defect pattern.)

W: Width, L: Length, S: Area

Note2: Inspection conditions are as follows.

Temperature	$25 \pm 5^\circ\text{C}$
Inspection viewing distance	20cm (The distance between the inspector's eye and screen.)
Inspection direction	$0^\circ \leq \theta_R \leq 45^\circ, 0^\circ \leq \theta_L \leq 45^\circ$
	$0^\circ \leq \theta_U \leq 45^\circ, 0^\circ \leq \theta_D \leq 45^\circ$
Illumination	700lx (at an inspection desk surface)

5. RELIABILITY TESTS

Test item	Condition	Judgement	Note1
High temperature and humidity(Operation)	① 50±2℃,RH=85%,240hours ② Display data is black	No display malfunctions	
Heat cycle (Operation)	① 0±3℃...1hour 55±3℃...1hour ② 50cycles,4hours/cycle ③ Display data is black		
Thermal shock (Non operation)	① -20±3℃...30minutes 60±3℃...30minutes ② 100cycles,1hour/cycle ③ Temperature transition time is within 5 minutes.		
ESD (operation)	① 150Pf,150Ω,±10kV ② 9 places on a panel surface ③10 times each places at 1 sec interval		
Dust (operation)	① Sample dust: No.15(byJIS-Z8901) ② 15 seconds stir ③ 8 times repeat at 1 hour interval		
Vibration (Non operation)	① 5-100Hz, sine wave,11.76m/S ² ② 1 minutes/cycle ③ X,Y,Z direction ④ 50 times each directions		
Mechanical shock (Non operation)	① 294m/S ² , 11ms ② ±X, ±Y, ±Z direction ③ 3 times each directions		
Low pressure	operation	No display malfunctions	
	non-operation		

Note1: Display and appearance are checked under environmental conditions equivalent to the inspection conditions of defect criteria.

Note2: See the following figure for discharge points.

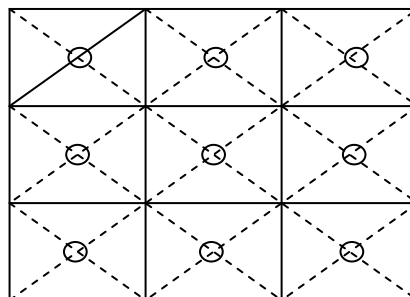

6. ESTIMATED LUMINANCE LIFETIME

The luminance lifetime is the time from initial luminance to half-luminance.

This lifetime is the estimated value, and is not guarantee value.

Condition		Luminance lifetime(MTTF) Note1,Note2	Unit
Module	25°C(Ambient temperature of the product) Continuous operation and IBL=7.5mArms/lamp	40,000	h
	50°C(Surface temperature at screen center) Continuous operation and IBL=7.5mArms/lamp	35,000	h
Cold cathode Fluorescent lamp	25°C(Ambient temperature of the product) Continuous operation and IBL=7.5mArms/lamp	50,000	h

Note1: MTTF is mean time to half-luminance.

Note2: In case the product works under low temperature environment, the lifetime becomes short.

7. MARKINGS

The various markings are attached to this product. See “8.4 INDECATION LOCATIONS” for attachment positions.

7.1 NAMEPLATE LABEL

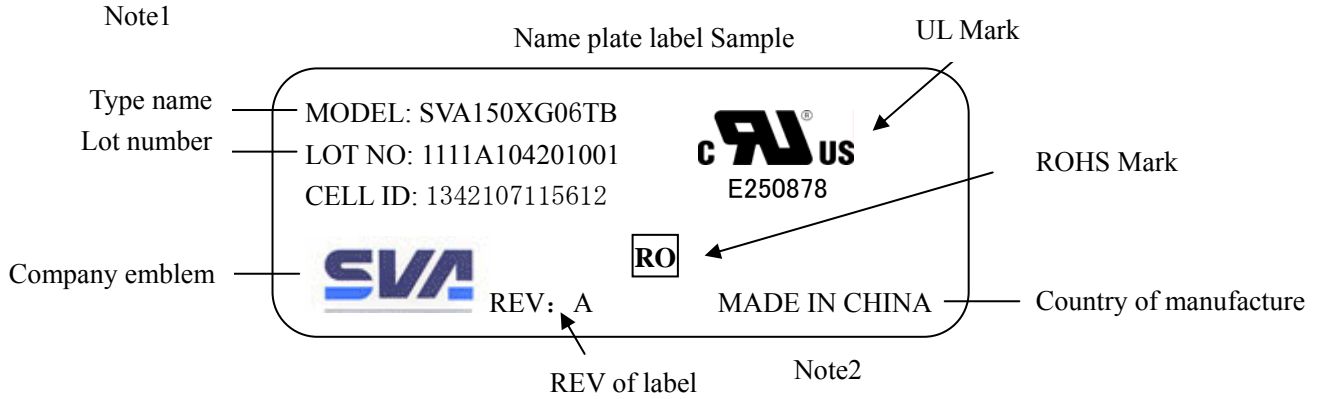

Note1: The meaning of lot number

•Example: 1111A104201001

<u>1111</u>	<u>A</u>	<u>1</u>	<u>04</u>	<u>9</u>	<u>01</u>	<u>001</u>
Internal use	Revision 1 letter (Alphabet)	Internal use	Manufacturing year 2 figures of the A.D. end numbers (e.g. A.D2004 is 04.)	Manufacturing month 1 letter	Manufacturing day	Production number Multi-letter (figure)

Jan. to Sep.: Number of month
 October: A
 November: B
 December: C

Note2: **Do not attach anything such as label and so on, on the nameplate!** In case repair the product, SVA-NEC needs the contents of nameplate such as the lot number, inspection date and so on, to identify the warranty period with individual product. If SVA-NEC cannot decipher the contents of nameplate, such repair shall be entitled to charge. Also SVA-NEC may give a new lot number to reconditioned products.

7.2 BARCODE LABEL



7.3 OTHER MARKINGS

High voltage caution marking



Disposal method marking for lamp

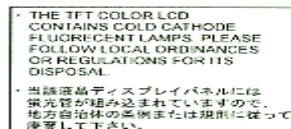

7.4 INDICATION LOCATIONS

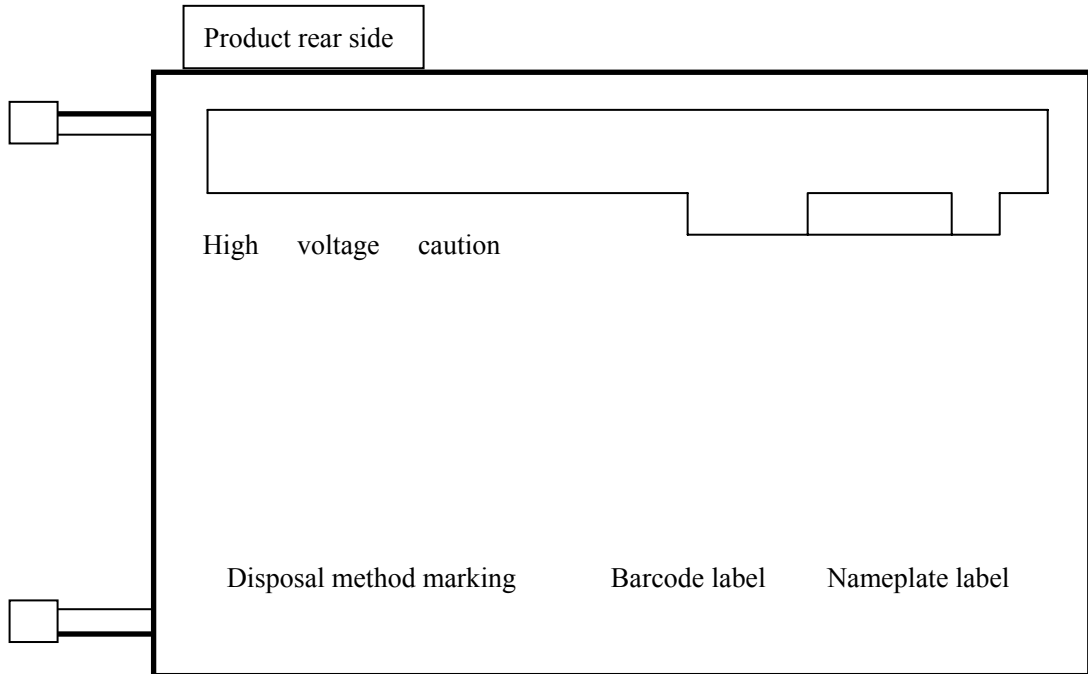

8. PACKING, TRANSPORTATION AND DELIVERY

SVA-NEC will pack products to deliver to customer in accordance with SVA-NEC packing specifications, and will deliver products to customer in such a state that products will not suffer from a damage during transportation .The delivery conditions are as follows.

8.1 PACKING

(1) Packing box

10 products are packed up with the maximum in a packing box(See “**9.5 OUTLINE FIGURE FOR PACKING**”).

Products are put into a plastic bag for prevention of moisture with cushion, and then the bag is sealed up with heat sealing.

The type name and quality are shown on outside of the packing box, either labeling or printing.

(2)Pallet Packing (See” **9.5 OUTLINE FIGURE FOR PACKING** “)

- ① Packing boxes are tired on a cardboard pallet.(9 boxes×4 tiers maximum)
- ②Cardboard sleeve and top cap are attached to the packing boxes, then they are fixed by a band.

8.2 INSPECTION RECORD SHEET

Inspection record sheets are included in the packing box with delivery products to customer. It is summarized to a number of products for pass/fail assessment.

8.3 TRANSPORTATION

The product is transported by vehicle, aircraft or shipment in the state of pallet packing.

8.4 SIZE AND WEIGHT FOR PACKING BOX

Parameter	Packing box	Unit
Size	319 (L) x374 (W) x407 (H) (typ.)	mm
Weight	1.6 (typ.)	kg
Total weight	11.3 (typ.) (with 10 products)	kg

8.5 OUTLINE FIGURE FOR PACKING

(1) Packing box

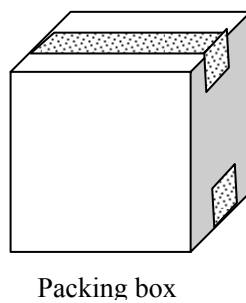
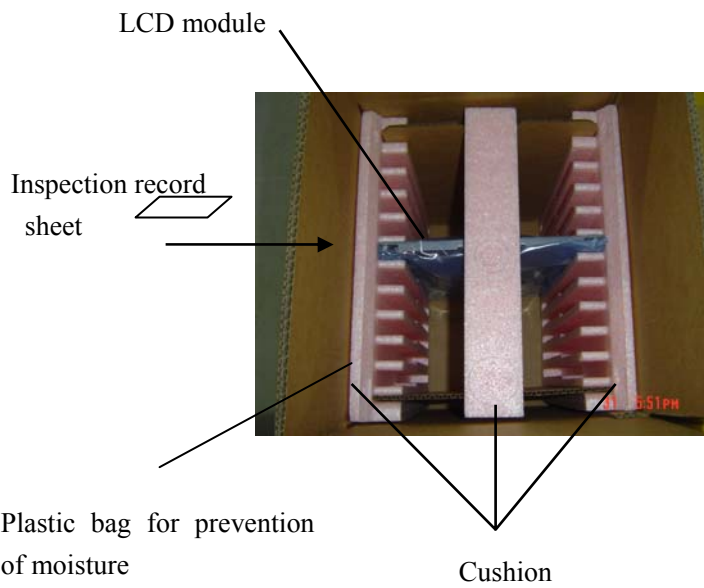
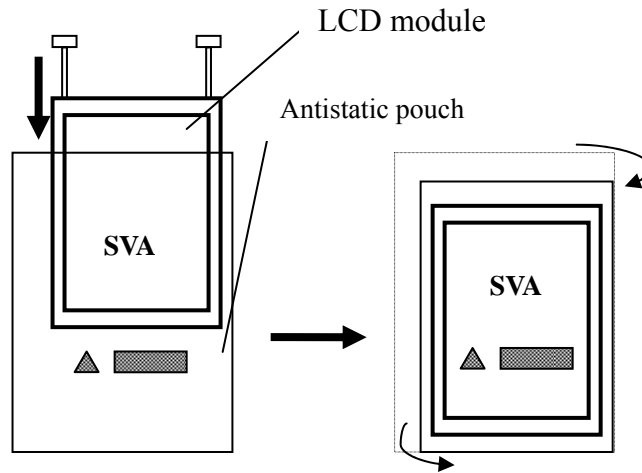

(2) Pallet packing

Note: The ways for Packing and Shipping vary from different shipment volume, dependent on specific situations.

Packing boxes (9 boxes×4 tiers maximum)

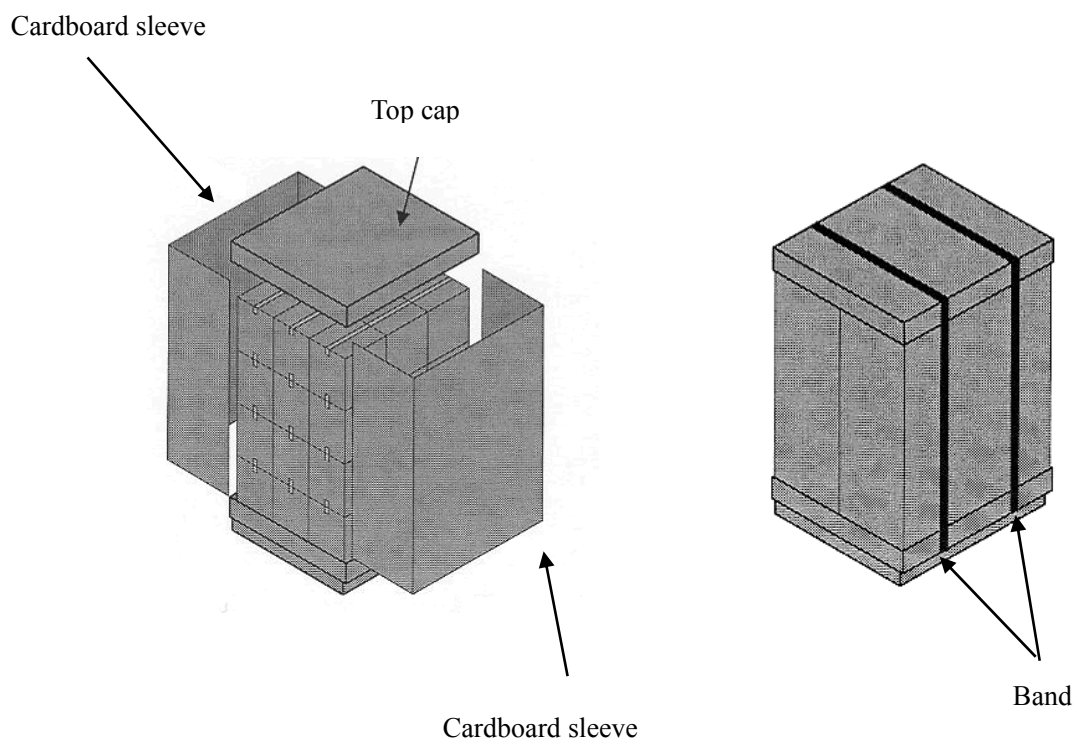
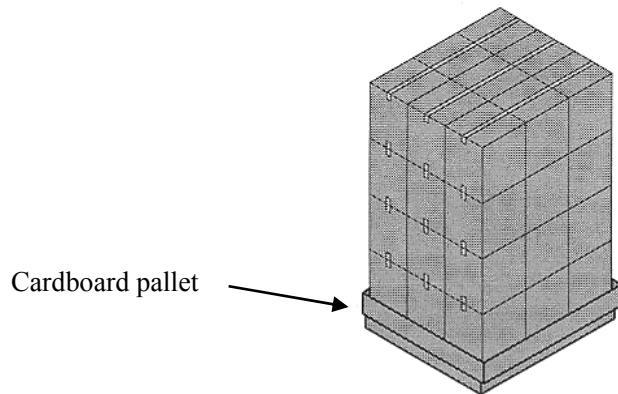

9. PRECAUTIONS

9.1 MEANING OF CAUTION SIGNS

The following caution signs have very important meaning **.Be sure to read “10.2 CAUTIONS” and “10.3 ATTENTIONS”, after understanding these contents!**



This sign has the meaning that customer will be injured by himself or the product will sustain a damage, if customer has wrong operations.



This sign has the meaning that customer will get an electrical shock, if customer has wrong operations.



This sign has the meaning that customer will be injured by himself, if customer has wrong operations.

9.2 CAUTIONS



*** Do not touch lamp cables while turn on .Customers will be in danger of an electric shock**



*** Do not touch the working backlight and IC. Customers will be in danger of burn injury.**
*** Do not shock and press the LCD panel and the backlight! There is a danger of breaking, because they are made of glass.(shock :To be not greater 294m/s² and to be not greater 11ms, Pressure: To be not greater 19.6N)**

9.3 ATTENTIONS



9.3.1 Handling of the product

- ① Take hold of both ends without touch the circuit board when customer pulls out products (LCD modules) from inner packing box. If customer touches it, products may be broken down or out of adjustment, because of stress to mounting parts.
- ② Do not hook cables nor pull connection cables such as flexible cable and so on , for fear of damage.
- ③ If customer puts down the product temporarily, the product puts on flat subsoil as a display side turns down.
- ④ Take the measures of electrostatic discharge such as earth band, ionic shower and so on, when customer deal with the product, because products may be damaged by electrostatic.
- ⑤ The torque for mounting screws must never exceed 0.34N-m. Higher torque values might result in distortion of the bezel.
- ⑥ The product must be installed using mounting holes without undue stress such as bends or twist (See outline drawings).And do not add undue stress to any portion (such as bezel flat area) except mounting hole portion. Bends or twist described above and undue stress to any portion except mounting hole portion may cause display

un-uniformity.

- ⑦ Do not press or rub on the sensitive display surface .If customer clean on the panel surface, SVA-NEC recommends using the cloth with ethanolic liquid such as screen cleaner for LCD.
- ⑧ Do not push-pull the interface connectors while the product is working, because wrong power sequence may break down the product.
- ⑨ Do not bend or unbend the lamp cable at the near part of the lamp holding rubber, to avoid the damage for high voltage side of the lamp. This damage may cause a lamp breaking and abnormal operation of high voltage circuit.

9.3.2 Environment

- ① Do not operate or store in high temperature, high humidity, dewdrop atmosphere or corrosive gases. Keep the product in antistatic pouch in room temperature, because of avoidance for dusts and sunlight, if customer stores the product.
- ② In order to prevent dew condensation occurring by temperature difference, the product packing box must be opened after leave under the environment of an unpacking room temperature enough. Because a situation of dew condensation occurring is changed by the environment temperature and humidity, evaluate the leaving time sufficiently. (Recommendation leaving time: 6 hour or more with packing state)
- ③ Do not operate in a high magnetic field .Circuit boards may be broken down by it.
- ④ This product is not designed as radiation hardened.
- ⑤ Use an original protection sheet on the product surface (polarizer). Adhesive type protection sheet should be avoided, because it may change color or properties of the polarizer.

9.3.3 Characteristics

The following items are neither defects nor failures.

- ① Response time, luminance and color may be changed by ambient temperature.
- ②The LCD may be seemed luminance non-uniformity, flicker, vertical seam or small spot by display patterns.
- ③Optical characteristics (e.g. luminance, display uniformity, etc.) gradually is going to change depending on operating time ,and especially low temperature, because the LCD has cold cathode fluorescent lamps.
- ④Do not display the fixed pattern for a long time because it may cause image sticking .Use a screen saver, if the fixed pattern is displayed on the screen.
- ⑤The display color may be changed by viewing angle because of the use of condenser sheet in the backlight.
- ⑥Optical characteristics may be changed by input signal timings.
- ⑦The interference noise of input signal frequency for this product and luminance control frequency of customer's backlight inverter may appear on a display. Set up luminance control frequency of backlight inverter so that the interference noise doses not appear.

9.3.4 Other

- ①All GND and VCC terminals should be used without a non-connected line.
- ②Do not disassemble a product or adjust volume without permission of SVA-NEC.
- ③See “REPLACEMENT MANUAL FOR LAMPHOLDER SET”, if customer would like to replace backlight lamps.
- ④Pay attention not to insert waste materials inside of products, if customer uses screw nails.
- ⑤Pack the product with original shipping package, because of avoidance of some damages during transportation, when customer returns it to SVA-NEC for repair and so on .
- ⑥Not only the module but also the equipment should be packed and transported as the module. becomes vertical .Otherwise, there is the fear that a display dignity decreases by an impact or vibrations.

10.OUTDRAWING

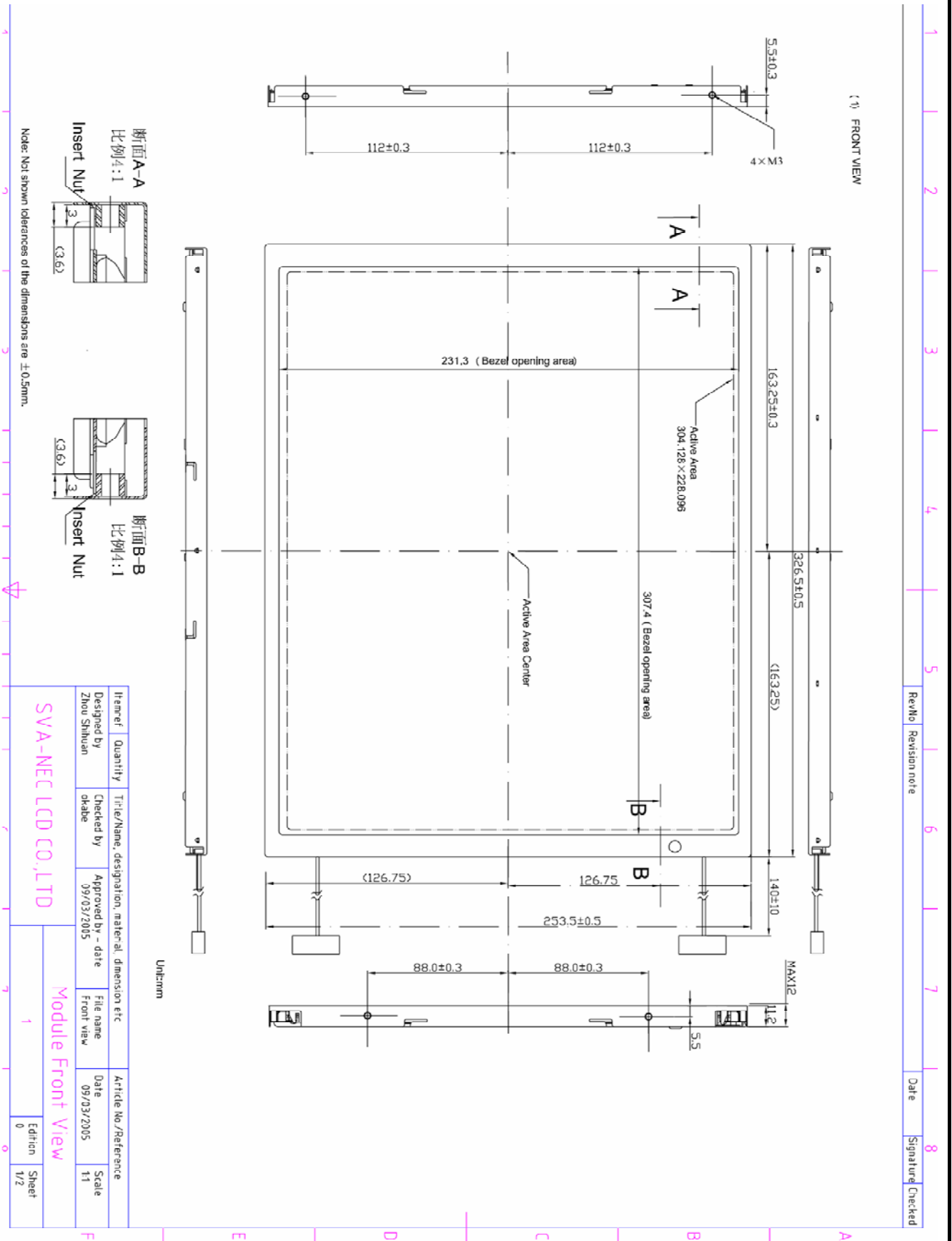

Header	Quantity	Title/Name, designation, material, dimension etc	Article No./Reference
Designed by Zhou Shihuan	Checked by dsh	Approved by - date 09/03/2005	Date 09/03/2005
SVA-NEC LCD CO.,LTD			Module Front View
1			1/2

RevNo	Revision note	Date	Signature	Checked
1				

(2) REAR VIEW

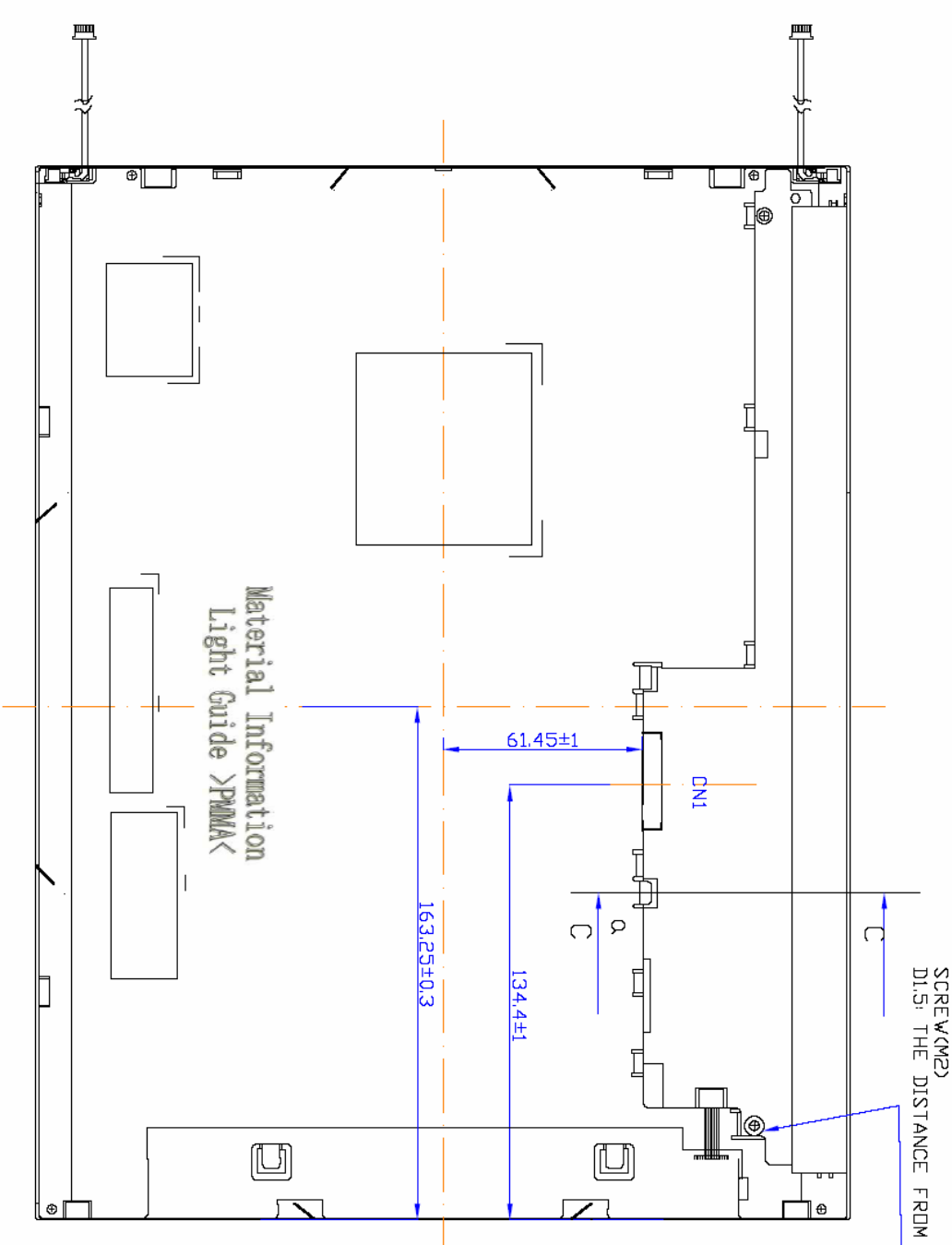

Material Information
Light Guide >PMMA<

断面C-C
比例2:1

UNIT: mm

NOTE: NOT MARKED TOLERANCES IN THE FIGURE ARE ±0.5mm.

RevNo	Revision note	Date	Signature	Checked

Itemref	Quantity	Title/Name, designation, material, dimension etc	Article No./Reference
Designed by Zhou Shihuan	Checked by okabe	Approved by - date 2005/03/10	Date 2005/03/10
File name rear view			Scale 1:1

SVA-NEC LCD CO., LTD		Module Rear View	
2		Edition 0	
2		Sheet 2/2	

Rev	Revised date	Main Revision item and sign	Approved by	Checked by	Prepared by	Published date																												
1.0		<p style="text-align: center;">New publication</p> <table border="1" style="width: 100%; border-collapse: collapse;"> <tr> <td style="width: 20px; text-align: center;">S i g n</td> <td style="width: 40px; text-align: center;">品 管 部</td> <td style="width: 40px; text-align: center;">营 销 部</td> <td style="width: 40px; text-align: center;">应 用 技 术</td> <td style="width: 40px; text-align: center;">产 品 技 术</td> <td style="width: 40px;"></td> <td style="width: 40px;"></td> </tr> <tr><td></td><td></td><td></td><td></td><td></td><td></td><td></td></tr> <tr><td></td><td></td><td></td><td></td><td></td><td></td><td></td></tr> <tr><td></td><td></td><td></td><td></td><td></td><td></td><td></td></tr> </table>	S i g n	品 管 部	营 销 部	应 用 技 术	产 品 技 术																											
S i g n	品 管 部	营 销 部	应 用 技 术	产 品 技 术																														
		<table border="1" style="width: 100%; border-collapse: collapse;"> <tr><td></td><td></td><td></td><td></td><td></td><td></td><td></td></tr> <tr><td></td><td></td><td></td><td></td><td></td><td></td><td></td></tr> <tr><td></td><td></td><td></td><td></td><td></td><td></td><td></td></tr> <tr><td></td><td></td><td></td><td></td><td></td><td></td><td></td></tr> </table>																																