



Shanghai SVA - NEC Liquid Crystal Display Co., Ltd.

TFT COLOR LCD MODULE

(COMMON)

SVA170SX01TB

43cm (17.0 Type)

SXGA

LVDS Interface (2port)

DATA SHEET

(Version 3.0)

Published by

Technology Department

SVA - NEC Liquid Crystal Display Co., Ltd.

Approved by

Date

K. Kinoshita

05.10.1

Checked by

Date

S. Okabe

2005.11.1

Prepared by

Date

Yang Gang

2005.11.1

Signature of customer

Confirmed by

Date

INTRODUCTION

• WARRANTY

Shanghai SVA NEC Liquid Crystal Display Co., Ltd. (hereinafter called "SVA-NEC") warrants that this product meets the product specifications set forth in this document. If this product under normal operation is found to be non-conforming to the product specifications, and such non-conformance is promptly notified to SVA-NEC within one (1) year after the delivery date, and further such non-conformance is solely attributable to SVA-NEC, SVA-NEC shall repair the non-conforming product or replace it with a conforming one, free of charge. However, this warranty does not apply to any non-conformance that can be found easily by incoming inspections or those resulting from any one of the following:

- 1) Unauthorized or improper repair, maintenance or modification
- 2) Operation or use against specifications, instructions or warnings given by SVA-NEC
- 3) Any other causes attributable to customer

In case SVA-NEC repairs or replaces a product after the one (1)-year warranty period, SVA-NEC shall be entitled to charge for such repair or replacement. Those replaced parts shall be covered with six (6)-month warranty period from the replacement day. Non-conforming products may be replaced with substitutes instead of repair when the manufacture of this product has been terminated.

EXCEPT AS EXPRESSLY SET FORTH HEREIN, SVA-NEC DISCLAIMS ANY WARRANTIES, EXPRESS OR IMPLIED, INCLUDING BUT NOT LIMITED TO MERCHANTABILITY AND FITNESS FOR A PARTICULAR PURPOSE, AND DISCLAIMS ANY REMEDIES.

• MAINTENANCE

The specifications of maintenance parts may be partially changed within equivalent quality or better. In this product, SVA-NEC will not accept to maintain for only mounting parts on circuit board (e.g. connector, fuse, capacitor, resistor, etc.) and only backlight conformation parts (e.g. reflector sheet, light guide plate, etc.).

If SVA-NEC is planning discontinuation for this product, SVA-NEC shall inform it to customers in six (6)-months advance from the issued date of official agreements. In addition, after product discontinuation, SVA-NEC may replace substitutes instead of maintenance parts with whole product.

• CHANGE CONTROL

For the purpose of product improvement, this product design may be changed for specifications, appearance, parts, circuits and so on. In case a design change is affected on the product specifications, SVA-NEC shall inform it to customers in advance.

• HANDLING OF DOUBTFUL POINTS

Any question arising out of, or in connection with, this SPECIFICATION or any matter not stipulated herein will be settled each time upon consultation between both parties.

CONTENTS

INTRODUCTION	2
CONTENTS	3
1. OUTLINE	4
1.1 STRUCTURE AND PRINCIPLE	4
1.2 APPLICATIONS.....	4
1.3 FEATURES.....	4
2. GENERAL INFORMATION	5
3. BLOCK DIAGRAM.....	6
4. DETAILED SPECIFICATION.....	7
4.1 MECHANICAL SPECIFICATIONS	7
4.2 ABSOLUTE MAXIMUM RATINGS	7
4.3 ELECTRICAL CHARACTERISTICS.....	8
4.4 POWER SUPPLY VOLTAGE SEQUENCE AND RIPPLE	9
4.5 INTERFACE AND CONNECTOR PIN ALIGNMENT	11
4.6 LVDS I/F DATA CHART.....	13
4.7 DISPLAY COLORS AND INPUT DATA SIGNALS	15
4.8 INTERFACE TIMING	16
4.9 OPTICS.....	19
4.10 DEFECT CRITERIA.....	22
5. RELIABILITY TESTS	26
6. ESTIMATED LUMINANCE LIFETIME.....	27
7. PACKING, TRANSPORTATION AND DELIVERY	28
7.1 PACKING.....	28
7.2 INSPECTION RECORD SHEET	28
7.3 TRANSPORTATION.....	28
7.4 SIZE AND WEIGHT FOR PACKING BOX	28
7.5 OUTLINE FIGURE FOR PACKING	29
8. PRECAUTIONS.....	31
8.1 MEANING OF CAUTION SIGNS.....	31
8.2 CAUTIONS	31
8.3 ATTENTIONS	31
9. OUTDRAWING	33
9.1 FRONT VIEW.....	33
9.2 REAR VIEW	34

1. OUTLINE

1.1 STRUCTURE AND PRINCIPLE

SVA170SX01TB module is composed of the amorphous silicon thin film transistor liquid crystal display (a-Si TFT LCD) panel structure with driver LSIs for driving the TFT (Thin Film Transistor) array and a backlight.

The a-Si TFT LCD panel structure is injected liquid crystal material into a narrow gap between the TFT array glass substrate and a color-filter glass substrate.

Color (Red, Green, Blue) data signals from a host system (e.g. PC, signal generator, etc.) are modulated into best form for active matrix system by a signal processing board, and sent to the driver LSIs which drive the individual TFT arrays.

The TFT array as an electro-optical switch regulates the amount of transmitted light from the backlight assembly, when it is controlled by data signals. Color images are created by regulating the amount of transmitted light through the TFT array of red, green and blue dots.

1.2 APPLICATIONS

- Monitor for PC

1.3 FEATURES

- a-Si TFT active matrix
- LVDS interface
- R.G.B input 8bit, 16.77 millions colors (6bit+FRC)
- Resolution SXGA:(1280×1024 pixels)
- Module size: 358.5(H) ×296.5(V) ×17.5MAX(D)mm
- High response time (Ton+Toff=8 ms)
- High gamut: (against NTSC 72%typ.)
- Edge light type backlight (4 CCFL lamps)
- Inverter less
- Replaceable lamp for backlight

2. GENERAL INFORMATION

Display area	337.92(H) x 270.34 (V) mm (typ.), [43.0 cm (17.0 inches)]
Drive system	a-Si TFT active matrix
Display color	16.77M colors (6bit+FRC)
Pixel	1,280 (H) x 1,024(V) pixels
Pixel arrangement	RGB (Red dot、 Green dot、 Blue dot) vertical stripe
Pixel pitch	0.264 (W) x 0.264 (H) mm
Module size	358.5(H) ×296.5(V) ×17.5MAX(D)mm
Weight	1920 g (typ.)
Contrast ratio	600:1(typ.)
Viewing angle (At the contrast ratio 10: 1)	<ul style="list-style-type: none"> • Horizontal: 130° (typ.) • Vertical: 110° (typ.)
Designed viewing direction	• Viewing angle with optimum grayscale ($\gamma=2.2$): normal axis
Color gamut	At LCD panel center 72 % (typ.) [against NTSC color space]
Response time	Ton (white 90%→ black 10%) + Toff (black 10%→ whjte 90%) 8 ms (typ.)
Luminance	At IBL = 7.5Arms / lamp 270cd/m2(typ.)
Signal system	LVDS 2port [RGB :8-bit, Dot clock (CLK), Data enable (DE)]
Power supply voltage	LCD panel signal processing board: 5.0V
Backlight	Edge light type: 4 cold cathode fluorescent lamps (Replaceable part)
Power consumption	At IBL=7.5Arms / lamp and checkered flag pattern 20.0W (typ.)

3. BLOCK DIAGRAM

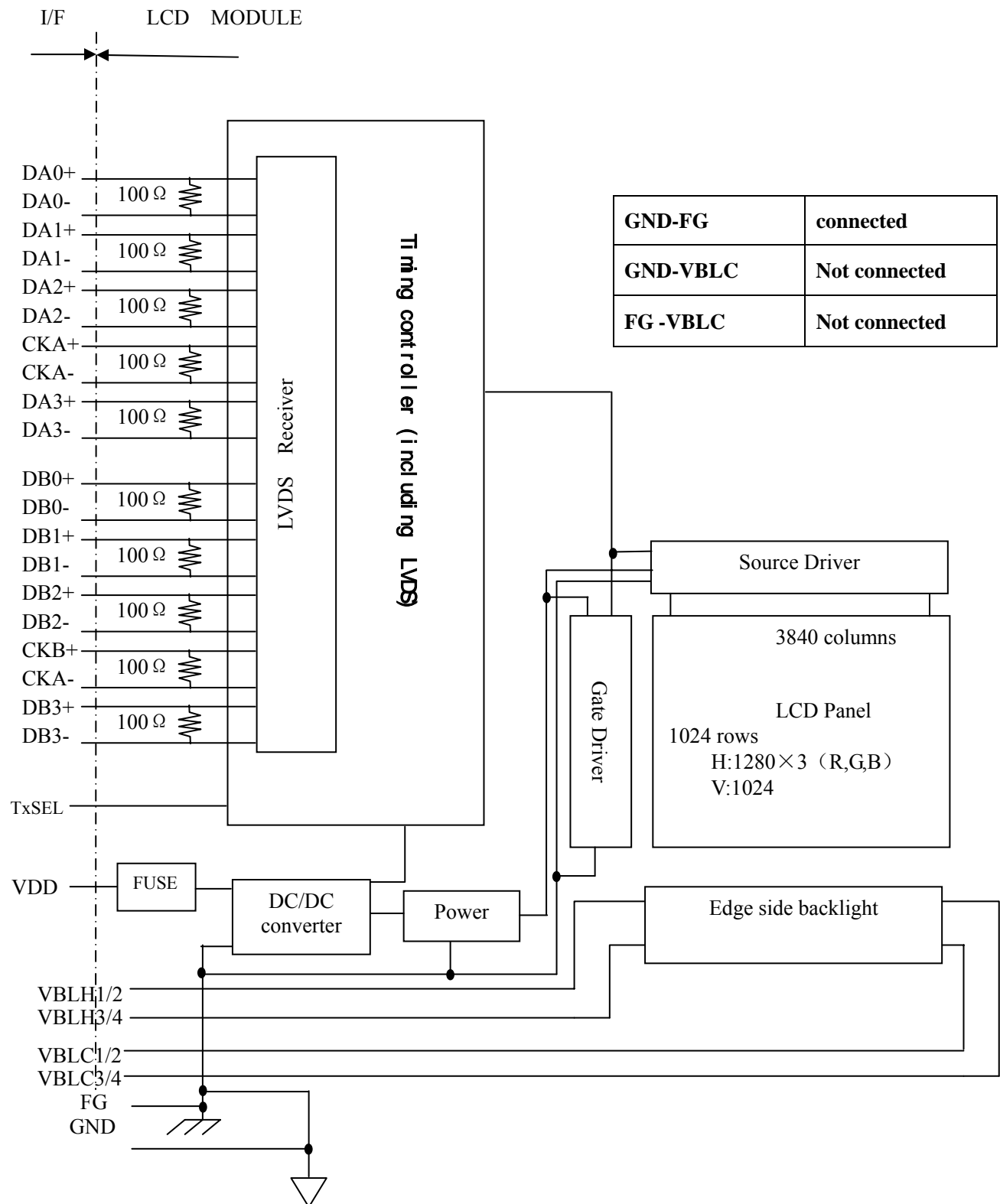

Note: System ground(GND), FG (Frame ground) and VBLC (Lamp low voltage terminal) in the product should be connected together in customer equipment.

4. DETAILED SPECIFICATION

4.1 MECHANICAL SPECIFICATIONS

Parameter	Specification	Unit
Module size	358.5± 0.5 (W) × 296.5 ± 0.5 (H) × 17.5 ± 0.5 (D) Note1	mm
Display area	337.92 (W) × 270.34 (H) Note1	mm
Display dot number	1280×3(H) ×1024(V)	-
Pixel pitch	0.264(H)×0.264(V)	mm
Dot pitch	0.088(H) ×0.264(H)	mm
Color arrangement	RGB (Red dot、 Green dot、 Blue dot) vertical stripe	-
Display color	16,777,216(6bit+FRC)	color
Weight	1920 (typ.), 2000(max.)	g

4.2 ABSOLUTE MAXIMUM RATINGS

Parameter		Symbol	Rating	Unit	Remarks
Power supply voltage	Power voltage	VDD	-0.3 ~+6.0	V	Ta = 25°C
	Lamp voltage	VBLH	2000	Vrms	Ta = 25°C
Lamp current		IBL	3.5~9.0	mArms	Ta = 25°C, for each lamp
Lamp Oscillation frequency		FO	40 ~ 80	kHz	Ta = 25°C
Input voltage for signals	Display signals	VD	-0.3~ 3.3	V	Ta = 25°C Note1
	Function signals	VF		V	Ta = 25 °C Note2
Storage temperature		Tst	-20 ~ +60	°C	-
Operating temperature	Front surface	TopF	0 ~ +50	°C	Note3
	Rear surface	TopR	0 ~+55	°C	Note4
Relative humidity Note5	RH	≤95	%	Ta ≤40° C	
		≤85		40° C < Ta ≤50° C	
Absolute humidity Note5	AH	≤70 Note6	g/m3	Ta > 50° C	
Operating altitude		-	≤4, 850	m	0° C ≤ Ta ≤ 55° C
Storage altitude		-	≤13, 600	m	-20° C ≤ Ta ≤ 60° C

Note1: Display signals are DA0+/-, DA1+/-, DA2+/-, DA3+/-, CKA+/-, DB0+/-, DB1+/-, DB2+/-, DB3+/-, and CKB+/-.

Note2: TxSEL

Note3: Measured at center of LCD panel surface (including self-heat)

Note4: Measured at center of LCD module's rear shield surface (including self-heat)

Note5: No condensation

Note6: Ta = 50°C, RH = 85%

4.3 ELECTRICAL CHARACTERISTICS

4.3.1 Driving for LCD panel signal processing board

(Ta=25°C)

Parameter	Symbol	min.	typ.	max.	Unit	Remarks	
Power supply voltage	VDD	4.5	5.0	5.5	V	-	
Power supply current	IDD	-	510 Note1	900 Note2	mA	at VDD = 5.0V	
Permissible ripple voltage	VRP	-	-	100	mV	VDD	
Differential input threshold voltage for LVDS receiver	Low	VTL	-100	-	-	mV	at VCM = 1.2V Note3
	High	VTH	-	-	+100	mV	
Input voltage width for LVDS receiver	VI	0	-	2.4	V	-	
Terminal resistor	RT	-	100	-	Ω	-	
Input voltage for TxSEL signal	Low	VFL	-	-	1.0	V	TxSEL Note4
	High	VFH	Please keep open			V	
Input current for TxSEL signal	IFL	-160	-	-17	μA		

Note1: Checked flag pattern (EIAJ ED-2522)

Note2: Pattern for maximum current (2H1V dot inverse, 0/255 scale)

Note3: Common mode voltage for LVDS driver

Note4: TxSEL is inside pull-up signal (pull-up resistor :about 50KΩ)

4.3.2 Driving for backlight lamp

(Ta=25°C) Note1

Parameter	Symbol	min.	typ.	max.	Unit	Remarks
Lamp voltage	VBLH	-	580	-	Vrms	Note2、 Note3
Lamp current	IBL	3.5	7.5	9.0	mA rms	Note3
Lamp starting voltage (discharge stabilization voltage)	Vs	970	-	-	Vrms	Ta = 25 Note2、 Note3
		1120	-	-	Vrms	Ta =0 Note2、 Note3
Lamp oscillation frequency	FO	40	48	55	kHz	Note4

Note1: The backlight of this product is made up of 4-piece lamp. The specification above is only for one lamp.

Note2: The voltage timing cycle of each lamp should be set as the same phase. [Vs] and [VBLH] is the voltage between the high port and low port, the value is the characteristic of lamp. The starting voltage of inverter should be higher than the value. The possibility of not lighting exists by the lower voltage, so the suitable voltage should be considered by the test .

Note3: The asymmetric ratio of working waveform for lamps (Lamp voltage peak ratio, Lamp current peak ratio and waveform area ratio) should be less than 5% (See the following figure). If the waveform is asymmetric, DC (Direct current) element applies into the lamp. In this case, a lamp lifetime may be shortened, because a distribution of a lamp enclosure substance inclines toward one side between low voltage terminal (Cold terminal) and high voltage terminal (Hot terminal).

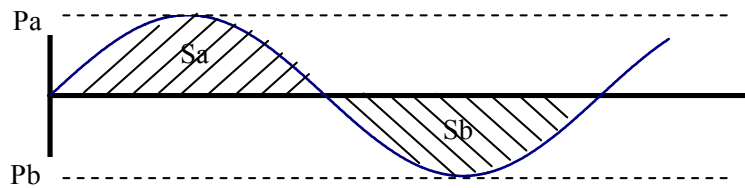

$$\begin{aligned} |Pa - Pb| / Pb \times 100 &\leq 5\% \\ |Sa - Sb| / Sb \times 100 &\leq 5\% \end{aligned}$$

Pa: Supply voltage/current peak for positive, Pb: Supply voltage/current peak for negative

Sa: Waveform space for positive part, Sb: Waveform space for negative part

Note4: In case "FO" is not the recommended value, beat noise may display on the screen, because of interference between "FO" and "1/th". Recommended value of "FO" is as following.

$$FO = 1/4 \times 1/th \times (2n-1)$$

Th: Horizontal signal period(See "4. 8.1 Timing characteristics".)

n: Natural number (1, 2, 3

4.4 POWER SUPPLY VOLTAGE SEQUENCE AND RIPPLE

4.4.1 Power supply voltage sequence

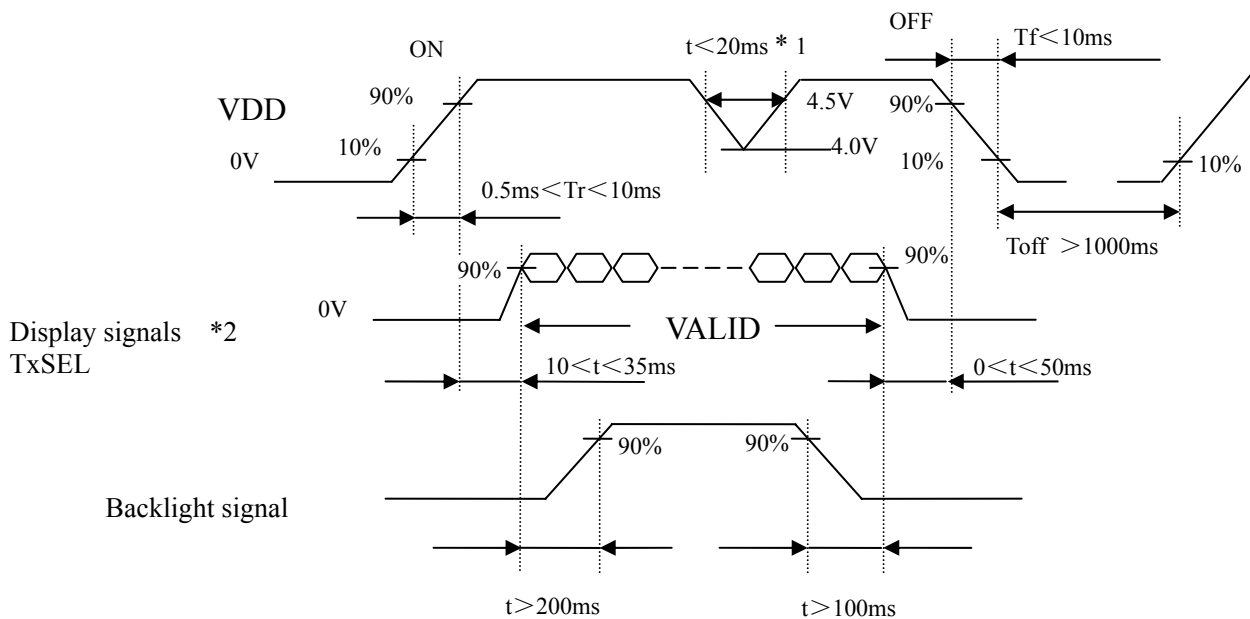

*1. When VDD is on, but the value is lower than 4.5V, a protection circuit may work, then the module may not display.

*2 The signal line is not connected with the module, at the end of cable the terminal resistor of 100Ω should be added.

Note1: Display signals (D0+/-, D1+/-, D2+/-, D3+/- and CK+/-) and function signal (MSL) must be "0" voltage, exclude the VALID period (See above sequence diagram). If these signals are higher than 0.3 V, the internal circuit is damaged.

If some of display and function signals (TxSEL) of this product are cut while this product is working, even if the signal input to it once again, it might not work normally. If customer stops the display and function signals (TxSEL), they should cut VDD.

Note2: When VDD is on, it should be set above 4.0V.

Note3: The backlight power supply voltage should be inputted within the valid period of display and function signals, in order to avoid unstable data display.

4.4.2 Power supply voltage ripple

When the power supply is designed, the next form can give the reference. If the voltage ripple is over the value in next form, the noise should be seen in display area.

Ripple (Measured at input terminal of power supply)

	VDD(5V to drive the panel)
Ripple voltage	≤100mVP-P (Including spike noise)

4.4.3 Fuse

Parameter	Fuse		Rating	Fusing current	Remarks
	Type	Supplier			
VDD	TF16SN3.15	KOA Corporation	2.5 A	6.3 A	Note1
			32 V		

Note1: The power supply capacity should be above twice than the fusing current. . If the power supply capacity is less than the fusing current, the fuse may blow in a short time, and then nasty smell, smoking and so on may occur.

4.4.4 Connectors for power supply and signals

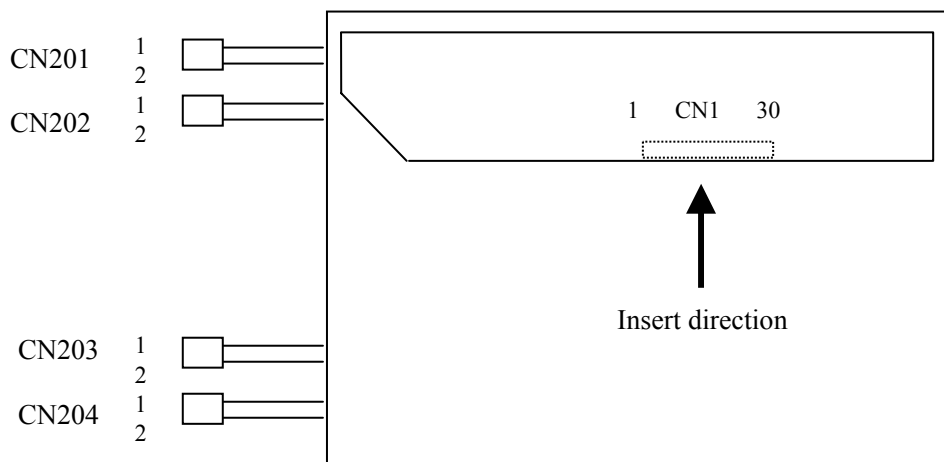

4.5 INTERFACE AND CONNECTOR PIN ALIGNMENT

CN1: FI-X30SSL-HF (Produced by JAE) <Adaptable connector: FI-X30C series or FI-X30H series or FI-X30M series (Produced by JAE), lock type is also adaptable.>

Pin No.	Symbol	Signal	Function
Frame	GND	Ground	Connect with the System GND
1	DA0-	Odd pixel data	Odd pixel data input(LVDS level)
2	DA0+	Odd pixel data	Odd pixel data input(LVDS level)
3	DA1-	Odd pixel data	Odd pixel data input(LVDS level)
4	DA1+	Odd pixel data	Odd pixel data input(LVDS level)
5	DA2-	Odd pixel data	Odd pixel data input(LVDS level)
6	DA2+	Odd pixel data	Odd pixel data input(LVDS level)
7	GND	Ground	System GND should be connected to the ground.
8	CKA-	Odd pixel clock	Odd pixel data's clock input(LVDS level)
9	CKA+	Odd pixel clock	Odd pixel data's clock input(LVDS level)
10	DA3-	Odd pixel data	Odd pixel data input(LVDS level)
11	DA3+	Odd pixel data	Odd pixel data input(LVDS level)
12	DB0-	Even pixel data	Even pixel data input(LVDS level)
13	DB0+	Even pixel data	Even pixel data input(LVDS level)
14	GND	Ground	System GND should be connected to the ground.
15	DB1-	Even pixel data	Even pixel data input(LVDS level)
16	DB1+	Even pixel data	Even pixel data input(LVDS level)
17	GND	Ground	System GND should be connected to the ground.
18	DB2-	Even pixel data	Even pixel data input(LVDS level)
19	DB2+	Even pixel data	Even pixel data input(LVDS level)
20	CKB-	Even pixel data	Even pixel data's clock input(LVDS level)
21	CKB+	Even pixel data	Even pixel data's clock input(LVDS level)
22	DB3-	Even pixel data	Even pixel data input(LVDS level)
23	DB3+	Even pixel data	Even pixel data input(LVDS level)
24	GND	Ground	System GND should be connected to the ground.
25	GND	Ground	System GND should be connected to the ground.
26	TxSEL	LVDS input format alternate	Open: A MODE System GND: B MODE Detailedly see "4.6 LVDS I/F DATA CHART"
27	GND	Ground	System GND should be connected to the ground.
28	VDD	Power supply	5V
29	VDD	Power supply	5V
30	VDD	Power supply	5V
Frame	GND	Ground	Connect with the System GND

CN1: The inserting side is as follows

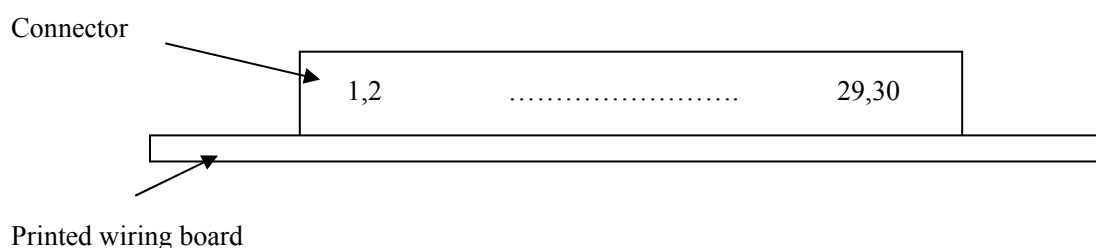

CN201: BHSR-02VS-1 (J.S.T Mfg. Co., Ltd.)

Adaptable connector: SM02B-BHSS-1-TB (J.S.T. Mfg Co., Ltd.)

Pin No.	Signal name	Function
1	VH1	High voltage input terminal for upper lamp(Cable color: Blue)
2	VL1	Low voltage input terminal for upper lamp(Cable color: Black)

CN202: BHSR-02VS-1 (J.S.T Mfg. Co., Ltd.)

Adaptable connector: SM02B-BHSS-1-TB (J.S.T. Mfg Co., Ltd.)

Pin No.	Signal name	Function
1	VH2	High voltage input terminal for upper lamp(Cable color: Pink)
2	VL2	Low voltage input terminal for upper lamp(Cable color: White)

CN203 : BHSR-02VS-1 (J.S.T Mfg. Co., Ltd.)

Adaptable connector: SM02B-BHSS-1-TB (J.S.T. Mfg Co., Ltd.)

Pin No.	Symbol name	Function
1	VH3	High voltage input terminal for lower lamp(Cable color: Blue)
2	VL3	Low voltage input terminal for lower lamp(Cable color: Black)

CN204: BHSR-02VS-1 (J.S.T Mfg. Co., Ltd.)

Adaptable connector: SM02B-BHSS-1-TB (J.S.T. Mfg Co., Ltd.)

Pin No.	Symbol name	Function
1	VH4	High voltage input terminal for lower lamp(Cable color: Pink)
2	VL4	Low voltage input terminal for lower lamp(Cable color: White)

Note1: The ports of VDD and GND should be all used. As for the input of LVDS, please use the twisted pair wire of the transmission impedance 100Ω.

Note2: System ground(GND), FG (Frame ground) and VBLC (Lamp low voltage terminal) in the product should be connected together in customer equipment.

4.6 LVDS I/F DATA CHART

A MODE

Input DATA		Transmitter		CN1				
		pin	DS90CF383,C385 or equivalent					
Odd pixel data and control signals	RA0	→ 51	TXIN0			pin	Symbol	
	RA1	→ 52	TXIN1	TA1-	→ 1	DA0-		
	RA2	→ 54	TXIN2	TA1+	→ 2	DA0+		
	RA3	→ 55	TXIN3					
	RA4	→ 56	TXIN4	TB1-	→ 3	DA1-		
	RA5	→ 3	TXIN6	TB1+	→ 4	DA1+		
	GA0	→ 4	TXIN7					
	GA1	→ 6	TXIN8	TC1-	→ 5	DA2-		
	GA2	→ 7	TXIN9	TC1+	→ 6	DA2+		
	GA3	→ 11	TXIN12		→ 7	GND		
	GA4	→ 12	TXIN13	TCLK1-	→ 8	CKA-		
	GA5	→ 14	TXIN14	TCLK1+	→ 9	CKA+		
	BA0	→ 15	TXIN15					
	BA1	→ 19	TXIN18	TD1-	→ 10	DA3-		
	BA2	→ 20	TXIN19	1'ST TD1+	→ 11	DA3+		
	BA3	→ 22	TXIN20					
	BA4	→ 23	TXIN21					
	BA5	→ 24	TXIN22					
	RSVD	→ 27	TXIN24					
	RSVD	→ 28	TXIN25					
	DE	→ 30	TXIN26					
	RA6	→ 50	TXIN27					
	RA7	→ 2	TXIN5					
	GA6	→ 8	TXIN10					
	GA7	→ 10	TXIN11					
	BA6	→ 16	TXIN16					
	BA7	→ 18	TXIN17					
	RSVD	→ 25	TXIN23					
	CLK	→ 31	CLKIN					
	Even pixel data	RB0	→ 51	TXIN0				
		RB1	→ 52	TXIN1	TA2-	→ 12	DB0-	
RB2		→ 54	TXIN2	TA2+	→ 13	DB0+		
RB3		→ 55	TXIN3		→ 14	GND		
RB4		→ 56	TXIN4	TB2-	→ 15	DB1-		
RB5		→ 3	TXIN6	TB2+	→ 16	DB1+		
GB0		→ 4	TXIN7		→ 17	GND		
GB1		→ 6	TXIN8	TC2-	→ 18	DB2-		
GB2		→ 7	TXIN9	TC2+	→ 19	DB2+		
GB3		→ 11	TXIN12					
GB4		→ 12	TXIN13	TCLK2-	→ 20	CKB-		
GB5		→ 14	TXIN14	TCLK2+	→ 21	CKB+		
BB0		→ 15	TXIN15					
BB1		→ 19	TXIN18	TD2-	→ 22	DB3-		
BB2		→ 20	TXIN19	2'nd TD2+	→ 23	DB3+		
BB3		→ 22	TXIN20		→ 24	GND		
BB4		→ 23	TXIN21		→ 25	GND		
BB5		→ 24	TXIN22		→ 26	TxSEL		
RSVD		→ 27	TXIN24		→ 27	GND		
RSVD		→ 28	TXIN25		→ 28	VDD		
RSVD		→ 30	TXIN26		→ 29	VDD		
RB6		→ 50	TXIN27		→ 30	VDD		
RB7		→ 2	TXIN5					
GB6		→ 8	TXIN10					
GB7		→ 10	TXIN11					
BB6		→ 16	TXIN16					
BB7		→ 18	TXIN23					
RSVD		→ 25	TXIN19					
CLK		→ 31	CLKIN					

B MODE

Input DATA		Transmitter				CN1		
		pin	THC63LVDF83A/R or equivalent	pin	THC63LVD823 or equivalent			
Odd pixel data and control signals	RA2	→ 51	TA0	53	R12			
	RA3	→ 52	TA1	54	R13	TA1-	→ 1 DA0-	
	RA4	→ 54	TA2	57	R14	TA1+	→ 2 DA0+	
	RA5	→ 55	TA3	58	R15			
	RA6	→ 56	TA4	59	R16	TB1-	→ 3 DA1-	
	RA7	→ 3	TA5	60	R17	TB1+	→ 4 DA1+	
	GA2	→ 4	TA6	63	G12			
	GA3	→ 6	TB0	64	G13	TC1-	→ 5 DA2-	
	GA4	→ 7	TB1	65	G14	TC1+	→ 6 DA2+	
	GA5	→ 11	TB2	66	G15		→ 7 GND	
	GA6	→ 12	TB3	67	G16	TCK1-	→ 8 CKA-	
	GA7	→ 14	TB4	68	G17	TCK1+	→ 9 CKA+	
	BA2	→ 15	TB5	73	B12			
	BA3	→ 19	TB6	74	B13	TD1-	→ 10 DA3-	
	BA4	→ 20	TC0	75	B14	TD1+	→ 11 DA3+	
	BA5	→ 22	TC1	76	B15			
	BA6	→ 23	TC2	1 st 77	B16			
	BA7	→ 24	TC3	78	B17			
	RSVD	→ 27	TC4	7	RSVD			
	RSVD	→ 28	TC5	8	RSVD			
	DE	→ 30	TC6	9	DE			
	RA0	→ 50	TD0	51	R10			
	RA1	→ 2	TD1	52	R11			
	GA0	→ 8	TD2	61	G10			
	GA1	→ 10	TD3	62	G11			
	BA0	→ 16	TD4	69	B10			
	BA1	→ 18	TD5	70	B11			
	RSVD	→ 25	TD6	-				
	CLK	→ 31	CLKIN	10	CLK			
	Even pixel data	RB2	→ 51	TA0	81	R22		
		RB3	→ 52	TA1	82	R23	TA2-	→ 12 DB0-
RB4		→ 54	TA2	83	R24	TA2+	→ 13 DB0+	
RB5		→ 55	TA3	84	R25		→ 14 GND	
RB6		→ 56	TA4	85	R26	TB2-	→ 15 DB1-	
RB7		→ 3	TA5	86	R27	TB2+	→ 16 DB1+	
GB2		→ 4	TA6	91	G22		→ 17 GND	
GB3		→ 6	TB0	92	G23	TC2-	→ 18 DB2-	
GB4		→ 7	TB1	2 nd 93	G24	TC2+	→ 19 DB2+	
GB5		→ 11	TB2	94	G25			
GB6		→ 12	TB3	95	G26	TCK2-	→ 20 CKB-	
GB7		→ 14	TB4	96	G27	TCK2+	→ 21 CKB+	
BB2		→ 15	TB5	99	B22			
BB3		→ 19	TB6	100	B23	TD2-	→ 22 DB3-	
BB4		→ 20	TC0	1	B24	TD2+	→ 23 DB3+	
BB5		→ 22	TC1	2	B25		→ 24 GND	
BB6		→ 23	TC2	5	B26		→ 25 GND	
BB7		→ 24	TC3	6	B27		→ 26 TxSEL	
RSVD		→ 27	TC4	-			→ 27 GND	
RSVD		→ 28	TC5	-			→ 28 VDD	
RSVD		→ 30	TC6	-			→ 29 VDD	
RB0		→ 50	TD0	79	R20		→ 30 VDD	
RB1		→ 2	TD1	80	R21			
GB0		→ 8	TD2	89	G20			
GB1		→ 10	TD3	90	G21			
BB0		→ 16	TD4	97	B20			
BB1		→ 18	TD5	98	B21			
RSVD		→ 25	TD6	-				
CLK		→ 30	CLKIN	-				

4.7 DISPLAY COLORS AND INPUT DATA SIGNALS

This product can display in equivalent to 16,777,216 colors in 256 scale. Also the relation between display colors and input data signals is as the following table.

Display colors		Data signal (0:Low level 、 1:High Level)																							
		RA7	RA6	RA5	RA4	RA3	RA2	RA1	RA0	GA7	GA6	GA5	GA4	GA3	GA2	GA1	GA0	BA7	BA6	BA5	BA4	BA3	BA2	BA1	BA0
		RB7	RB6	RB5	RB4	RB3	RB2	RB1	RB0	GB7	GB6	GB5	GB4	GB3	GB2	GB1	GB0	BB7	BB6	BB5	BB4	BB3	BB2	BB1	BB0
Basic color	Black	0	0	0	0	0	0	0	0	0	0	0	0	0	0	0	0	0	0	0	0	0	0	0	0
	Blue	0	0	0	0	0	0	0	0	0	0	0	0	0	0	0	0	1	1	1	1	1	1	1	1
	Red	1	1	1	1	1	1	1	1	0	0	0	0	0	0	0	0	0	0	0	0	0	0	0	0
	Magenta	1	1	1	1	1	1	1	1	0	0	0	0	0	0	0	0	1	1	1	1	1	1	1	1
	Green	0	0	0	0	0	0	0	0	1	1	1	1	1	1	1	1	0	0	0	0	0	0	0	0
	Cyan	0	0	0	0	0	0	0	0	1	1	1	1	1	1	1	1	1	1	1	1	1	1	1	1
	Yellow	1	1	1	1	1	1	1	1	1	1	1	1	1	1	1	1	0	0	0	0	0	0	0	0
	White	1	1	1	1	1	1	1	1	1	1	1	1	1	1	1	1	1	1	1	1	1	1	1	1
Red scale	Black	0	0	0	0	0	0	0	0	0	0	0	0	0	0	0	0	0	0	0	0	0	0	0	0
		0	0	0	0	0	0	0	1	0	0	0	0	0	0	0	0	0	0	0	0	0	0	0	0
	Dark	0	0	0	0	0	0	1	0	0	0	0	0	0	0	0	0	0	0	0	0	0	0	0	0
	↑				:							:								:					
	↓				:							:								:					
	Bright	1	1	1	1	1	1	0	1	0	0	0	0	0	0	0	0	0	0	0	0	0	0	0	0
	1	1	1	1	1	1	1	0	0	0	0	0	0	0	0	0	0	0	0	0	0	0	0	0	
Red	1	1	1	1	1	1	1	1	0	0	0	0	0	0	0	0	0	0	0	0	0	0	0	0	
Green scale	Black	0	0	0	0	0	0	0	0	0	0	0	0	0	0	0	0	0	0	0	0	0	0	0	0
		0	0	0	0	0	0	0	0	0	0	0	0	0	0	0	1	0	0	0	0	0	0	0	0
	Dark	0	0	0	0	0	0	0	0	0	0	0	0	0	0	1	0	0	0	0	0	0	0	0	0
	↑				:							:								:					
	↓				:							:								:					
	Bright	0	0	0	0	0	0	0	0	1	1	1	1	1	1	0	1	0	0	0	0	0	0	0	0
	0	0	0	0	0	0	0	0	1	1	1	1	1	1	1	0	0	0	0	0	0	0	0	0	
Green	0	0	0	0	0	0	0	0	1	1	1	1	1	1	1	1	0	0	0	0	0	0	0	0	
Bule scale	Black	0	0	0	0	0	0	0	0	0	0	0	0	0	0	0	0	0	0	0	0	0	0	0	0
		0	0	0	0	0	0	0	0	0	0	0	0	0	0	0	0	0	0	0	0	0	0	0	1
	Dark	0	0	0	0	0	0	0	0	0	0	0	0	0	0	0	0	0	0	0	0	0	0	1	0
	↑				:							:								:					
	↓				:							:								:					
	Bright	0	0	0	0	0	0	0	0	0	0	0	0	0	0	0	0	1	1	1	1	1	1	0	1
	0	0	0	0	0	0	0	0	0	0	0	0	0	0	0	0	1	1	1	1	1	1	1	0	
Blue	0	0	0	0	0	0	0	0	0	0	0	0	0	0	0	0	1	1	1	1	1	1	1	1	

Note: Combination with 8 bit(256 grayscale) R,G,B color signal , the color can be formed.

4.8 INTERFACE TIMING

4.8.1 Timing specification

Parameter		Symbol	min.	typ.	max.	Unit	Remarks
Clock	Frequency	1/tc	45	54	68	MHz	LVDS transmitter
		tc	16.7	18.52	20.0	ns	input
	Rise time, Fall time	-	Refer to the timing characteristics of LVDS transmitter			ns	-
	Duty	-				-	-
Horizontal signals	Cycle	th	12.50	15.63	20.46	μs	64.0kHz(typ.)
			672	844	1024	CLK	
	Display period	thd	640			CLK	-
Vertical signals	Cycle	tv	13.0	16.6	18.2	ms	60.0Hz(typ.)
			1032	1066	1536	H	
	Display period	tvd	1024			H	-
DE/Data	Setup time	-	Refer to the timing characteristics of LVDS transmitter			ns	-
	Hold time	-				ns	-
	Rise time, Fall time	-				ns	-

Note: It is suggested that the cycle of horizontal signals fluctuate in the range of $\pm 10\text{CLK}$. In case go beyond that range, probably the false action would happen to the loop .

For example, in case the cycle of horizontal signals is 844CLK, the allowable fluctuation range is 834~854CLK.

4.8.2 Input signal timing chart

Horizontal timing

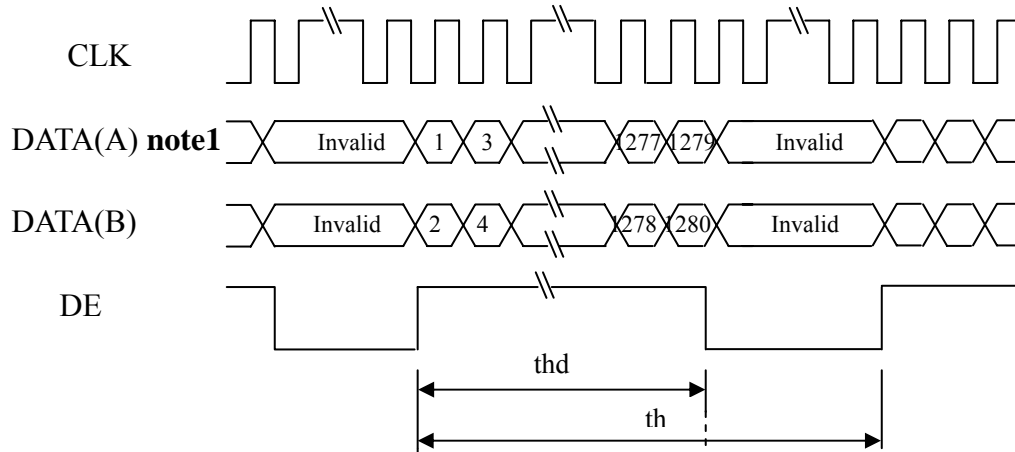

Vertical timing

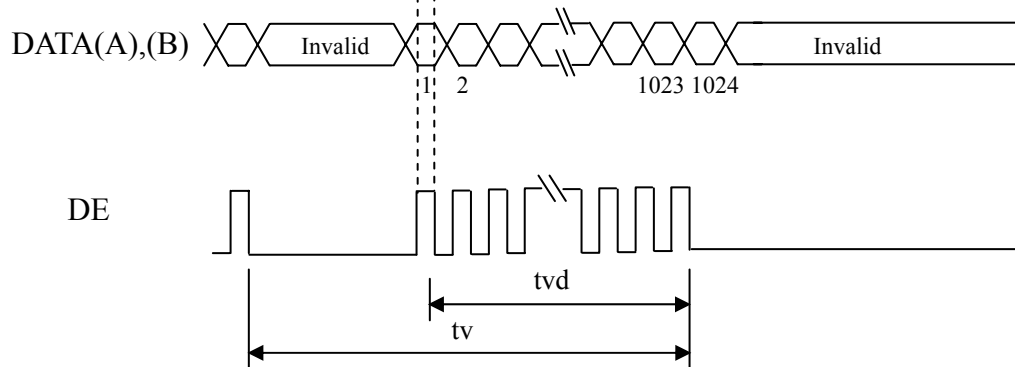

Note 1: DATA(A)=RA0-RA7,GA0-GA7,BA0-BA7

DATA(B)=RB0-RB7,GB0-GB7,BB0-BB7

4.9 OPTICS

4.9.1 Optical characteristics

Note1 ,Note2

Parameter Note1	Condition	Symbol	min.	typ.	max.	Unit	Remarks	
Luminance	White at center $\theta R=0^\circ, \theta L=0^\circ, \theta U=0^\circ, \theta D=0^\circ$	L	220	270	-	cd/ m ²	-	
Contrast ratio	White/Black at center $\theta R=0^\circ, \theta L=0^\circ, \theta U=0^\circ, \theta D=0^\circ$	CR	400	600	-	-	Note3	
Luminance uniformity	White $\theta R=0^\circ, \theta L=0^\circ, \theta U=0^\circ, \theta D=0$	LU	-	1.2	1.3	-	Note4	
Chromaticity	White	X coordinate	Wx	0.283	0.313	0.343	-	Note5
		Y coordinate	Wy	0.299	0.329	0.359	-	
	Red	X coordinate	Rx	0.62	0.65	0.68	-	
		Y coordinate	Ry	0.31	0.34	0.37	-	
	Green	X coordinate	Gx	0.27	0.30	0.33	-	
		Y coordinate	Gy	0.59	0.62	0.65	-	
	Blue	X coordinate	Bx	0.11	0.14	0.17	-	
		Y coordinate	By	0.04	0.07	0.10	-	
Color gamut	$\theta R=0^\circ, \theta L=0^\circ, \theta U=0^\circ, \theta D=0$ At center,against NTSC	C	65	72	-	%		
Response time	White to black	Ton	-	2	6	ms	Note6	
	Black to white	Toff	-	6	14	ms	Note7	
Viewing angle	Right	$\theta U=0^\circ, \theta D=0^\circ, CR=10$	θR	50	65	-	°	Note8
	Left	$\theta U=0^\circ, \theta D=0^\circ, CR=10$	θL	50	65	-	°	
	Up	$\theta R=0^\circ, \theta L=0^\circ, CR=10$	θU	30	45	-	°	
	Down	$\theta R=0^\circ, \theta L=0^\circ, CR=10$	θD	50	65	-	°	

Note1: The values in upper table are only initial characteristics.

Note2: Measurement conditions are as follows.

Ta=25°C, VDD=5.0V, IBL=7.5mA/m/lamp, Display mode: SXGA, Horizontal cycle=64.0KHz,
Vertical cycle=60.0Hz

Optical characteristics are measured at luminance saturation after 20minutes from working the product in the dark room. Also measurement method for luminance is as follows.

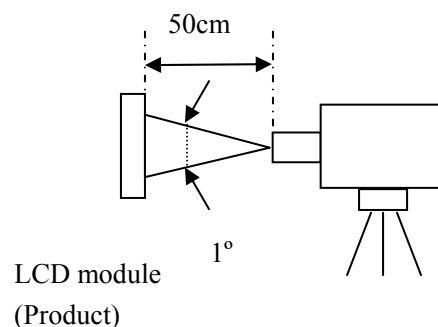

Luminance Meter (TOPCON BM-5A)
Spectroradiometer(TOPCON SR-3)

Note 3: See“4.9.2 Definition of contrast ratio”.

Note 4: See“4.9.3 Definition of luminance uniformity”.

Note 5: CIE 1931 Chromaticity Diagram Standard.

Note 6: Product surface temperature: TopF = 33.0

Note 7: See “4.9.4 Definition of response times”.

Note 8: See “4.9.5 Definition of viewing angles”.

4.9.2 Definition of contrast ratio

The contrast ratio is calculated by using the following formula.

$$\text{Contrast ratio (CR)} = \frac{\text{Luminance of white screen}}{\text{Luminance of black screen}}$$

4.9.3 Definition of luminance uniformity

The luminance uniformity is calculated by using the following formula.

$$\text{Luminance uniformity (LU)} = \frac{\text{Maximum luminance from ① to ⑤}}{\text{Minimum luminance from ① to ⑤}}$$

The luminance is measured at near the 5 points shown below.

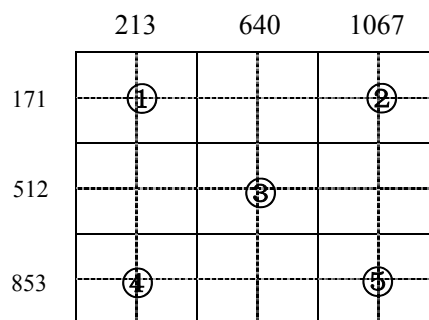

4.9.4 Definition of response times

Response time is measured, the luminance changes from “white” to “black”, or “black” to “white” on the same screen point, by photo-detector. Ton is the time it takes the luminance change from 90% down to 10%. Also Toff is the time it takes the luminance change from 10% up to 90%. (See the following diagram.)

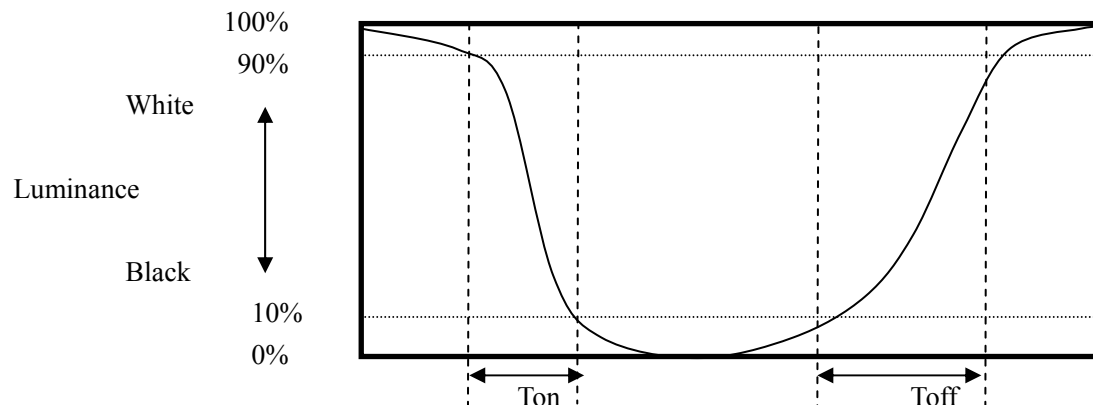

4.10 DEFECT CRITERIA

4.10.1 Display specification

(Note1, Note 2)

Defect pattern	Condition		Criteria	
Line defect	Display of black, white, red, green, blue		0 line	
Bright dots Note 2 Note 3	R+G+B		≤ 3 dots	
	Close defect dots Note 6	$15\text{mm} \leq D$ Note 5	Allowed	
	Linked defect dots Note 7	$D=0\text{mm}$ Note 5	2 defect dots	1 set
			3 defect dots or more	0 set
Dark dots Note 2 Note 4	R+G+B		≤ 3 dots	
	Close defect dots Note 6	$15\text{mm} \leq D$ Note 5	Allowed	
	Linked defect dots Note 7	$D=0\text{mm}$ Note 5	2 defect dots	≤ 1 set
			3 defect dots or more	0 set
Total	Bright dots+Dark dots		≤ 5 dots	

Note 1: Inspection conditions are as follows.

Temperature	25 ± 5
Inspection viewing distance	20cm(The distance between the inspector' s eye and screen)
Inspection direction	$0^\circ \leq \theta_R \leq 20^\circ$, $0^\circ \leq \theta_L \leq 20^\circ$
	$0^\circ \leq \theta_U \leq 20^\circ$
Inspection illumination	60lx(at a display surface)

Note 2: Defect area $> 1/2$ of one dot

Dot defects are include intermittent bright and dark dot.

Dots darker than half brightness of full bright dots are not defined as bright dot defect, and dots brighter than half brightness of full bright dots are not defined as dark dot defect.

Note 3: Bright dots are counted while the display is black.



Note 4: Dark dots are counted while the display is illuminated with Red, Green or Blue.

Note 5: **D** is the distance between defect dots.





Note 6: See“**4.10.2 Close defect dots**”.

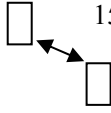
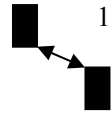
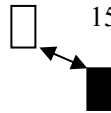

Note 7: See“**4.10.3 Linked defect dots**”.

4.10.2 Close defect dots

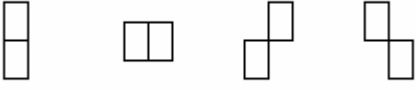
Defect pattern	 : Bright dot  : Dark dot	Criteria
Bright dots	 $15\text{mm} \leq D$	Allowed
Dark dots	 $15\text{mm} \leq D$	Allowed
Combinations between bright dot and dark dot	 $15\text{mm} \leq D$	Allowed

4.10.3 Linked defect dots

Defect pattern	 : Bright dot  : Dark dot	Criteria
2 defect dots		$\leq 1\text{set}$
		$\leq 1\text{ set}$
	Combination between bright dots and dark dot  Etc.	$\leq 2\text{ sets}$

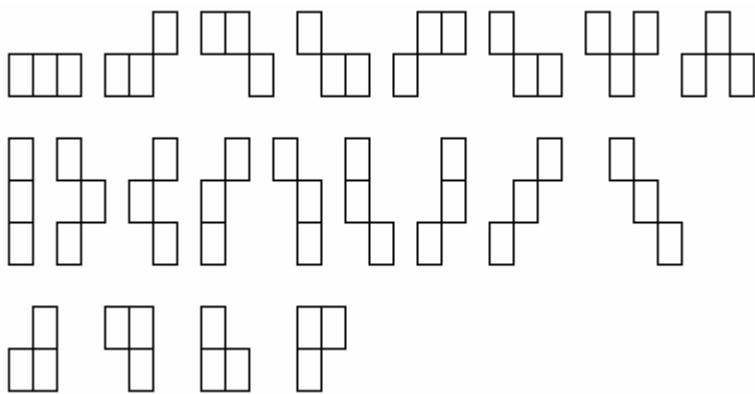
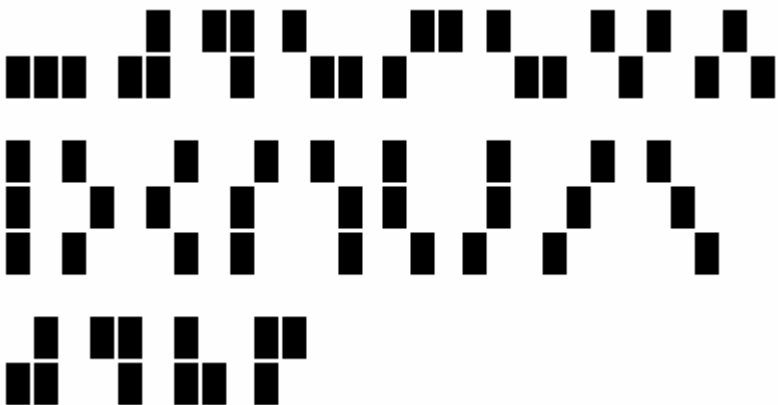
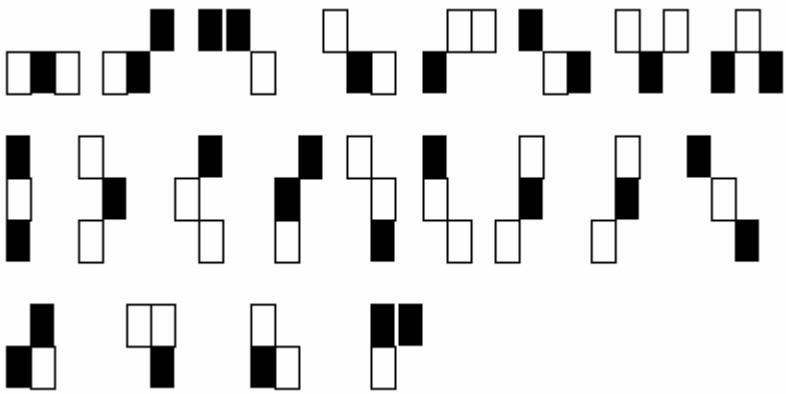
Defect pattern	 : Bright dot  : Dark dot	Criteria
3 defect dots	<p style="text-align: center;">Bright dot</p> 	0 set
	<p style="text-align: center;">Dark dot</p> 	
	<p style="text-align: center;">Combinations between bright dot and dark dot</p>  <p style="text-align: center;">Etc.</p>	Allowed

4.10.4 Appearance specifications

Defect pattern		Condition	Note 1	Criteria
Impure ingredient Stains Dust	Dot shape	$d < 0.2\text{mm}$		Allowed
		$0.2\text{mm} \leq d < 0.3\text{mm}$		≤ 10 points
		$0.3\text{mm} \leq d \leq 0.5\text{mm}$		≤ 3 points
		$d > 0.5\text{mm}$		0 point
	Adjacent other objects			
	Line shape	$W < 0.05\text{mm}$		Allowed
		$0.05\text{mm} \leq W \leq 0.1\text{mm}$	$L < 0.7\text{mm}$	
			$0.7\text{mm} \leq L \leq 1.0\text{mm}$	
$L > 1.0\text{mm}$			0 point	
$W > 0.1\text{mm}$				
Bubbles, Wrinkles, Dent		$d \leq 0.2\text{mm}$		Allowed
		$0.2\text{mm} < d \leq 0.5\text{mm}$		≤ 2 points
		$d > 0.5\text{mm}$		0 point
Polarizer scratch		$S \leq 0.2\text{mm}^2$		Allowed
		$S > 0.2\text{mm}^2$		0 point
Flick		Refer to limited samples		
Mura		Refer to limited samples		
Crosstalk		Refer to limited samples		

Note1: Definition of symbols is as follows.

d: Average diameter

(This diameter is the average length of a long axis and a short axis in each defect pattern.)

W: Width, L: Length, S: Area

Note2: Inspection conditions are as follows.

Temperature	$25 \pm 5^\circ\text{C}$
Inspection viewing distance	20cm (The distance between the inspector's eye and screen.)
Inspection direction	$0^\circ \leq \theta R \leq 45^\circ$, $0^\circ \leq \theta L \leq 45^\circ$
	$0^\circ \leq \theta U \leq 45^\circ$, $0^\circ \leq \theta D \leq 45^\circ$
Illumination	700lx (at an inspection desk surface)

Note3: If any problems arise with the LCMS suppliers by suppliers, the custom and supplier will cooperate and make efforts to solve it with mutual confidence and respect.

5. RELIABILITY TESTS

Test items	Condition
High temperature and humidity(Operation)	50±2 ,RH=85%,240hours Normal temperature and humidity,1~24hours Display data is black Note1
Heat cycle (Operation)	0±3 ...1hour 55±3 ...1hour 50cycles,4hours/cycle Display data is black
Thermal shock (Non operation)	-20±3 ...30minutes 60±3 ...30minutes 100cycles,1hour/cycle Temperature transition time is within 5 minutes.
ESD (operation)	150Pf,150Ω,±10kV 9 places on a panel surface 10 times each place at 1 sec interval Note2
Dust (operation)	Sample dust: No.15(byJIS-Z8901) 15 seconds stir 8 times repeat at 1 hour interval
Vibration (Non operation)	5-100Hz, acceleration of 11.76m/S ² 1 minutes/cycle X,Y,Z direction 10 times each direction
Mechanical shock (Non operation)	294m/S ² , 11ms ±X, ±Y, ±Z direction 3 times each direction
Low pressure	operation 53.3kPa (Equivalent to altitude 4,850m) 0 ±3 ...24hours 55 ±3 ...24hours
	non-operation 15kPa (Equivalent to altitude 13,600m) -20 ±3 ...24hours 60 ±3 ... 24hours

Note1: Display and appearance are checked under environmental conditions equivalent to the inspection conditions of defect criteria.

Note2: See the following figure for discharge points.

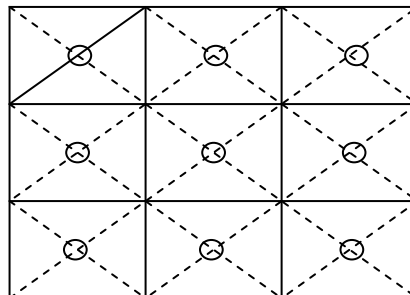

6. ESTIMATED LUMINANCE LIFETIME

The luminance lifetime is the time from initial luminance to half-luminance.

This lifetime is the estimated value, and is not guarantee value.

Condition		Luminance lifetime(MTTF) Note1	Unit
Module	(Ambient temperature of the product) Continuous operation and IBL=7.5mArms/lamp	TBD	h
	50 (Surface temperature at screen center) Continuous operation and IBL=7.5mArms/lamp	TBD	h
Cold cathode Fluorescent lamp, Note2	25 (Ambient temperature of the product) Continuous operation and IBL=7.5mArms/lamp	42000(min) 50000(typ)	h

Note1: MTTF is mean time to half-luminance. In case the product works under low temperature environment, the lifetime becomes short.

Note2: This is reference data. This is the CCFL lifetime, not the lifetime of LCD module.

7. PACKING, TRANSPORTATION AND DELIVERY

SVA-NEC will pack products to deliver to customer in accordance with SVA-NEC packing specifications, and will deliver products to customer in such a state that products will not suffer from a damage during transportation .The delivery conditions are as follows.

7.1 PACKING

(1) Packing box

5 products are packed up with the maximum in a packing box(See “7.5 OUTLINE FIGURE FOR PACKING “).

Products are put into a plastic bag for prevention of moisture.

The type name and quality are shown on outside of the packing box, either labeling or printing.

(2)Pallet Packing (See”7.5 OUTLINE FIGURE FOR PACKING “)

- ① Packing boxes are tired on a cardboard pallet.(12 boxes×3 tiers maximum)
- ②Cardboard sleeve and top cap are attached to the packing boxes, then they are fixed by a band.

7.2 INSPECTION RECORD SHEET

Inspection record sheets are included in the packing box with delivery products to customer. It is summarized to a number of products for pass/fail assessment.

7.3 TRANSPORTATION

The product is transported by vehicle, aircraft or shipment in the state of pallet packing.

7.4 SIZE AND WEIGHT FOR PACKING BOX

Parameter	Packing box	Unit
Size	360 (L) x 230 (W) x 440 (H) (typ.)	mm
Weight	1.45 (typ.)	kg
Total weight	11.15 (typ.) (with 5 products)	kg

7.5 OUTLINE FIGURE FOR PACKING

7.5.1 Packing box

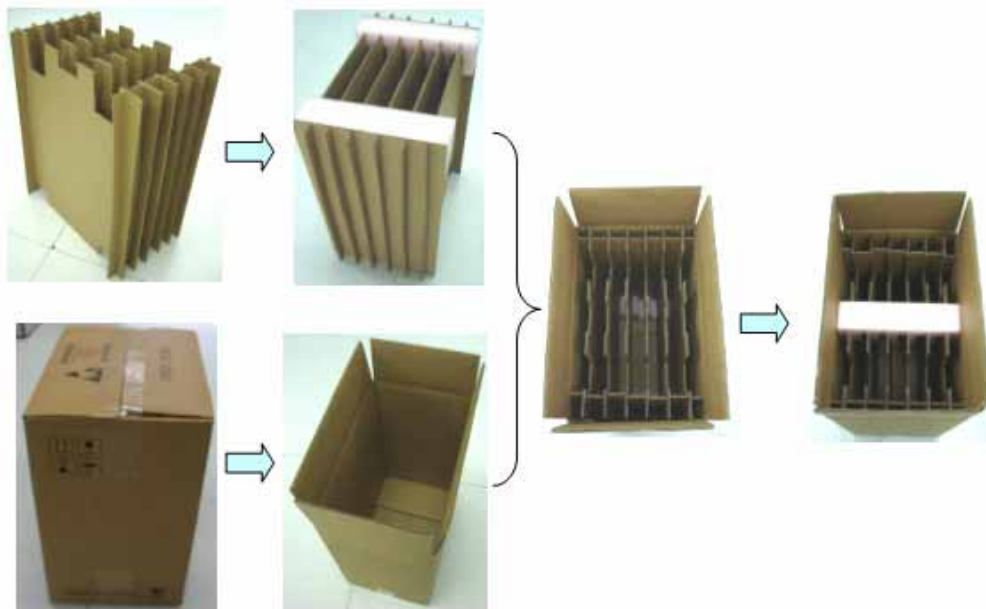

LCD module

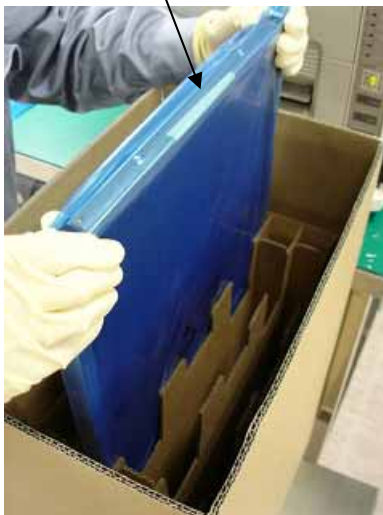

Packing box

7.5.2 Pallet packing

Note: The ways for Packing and Shipping vary from different shipment volume, dependent on specific situations.

Packing boxes (12boxes×3 tiers maximum)

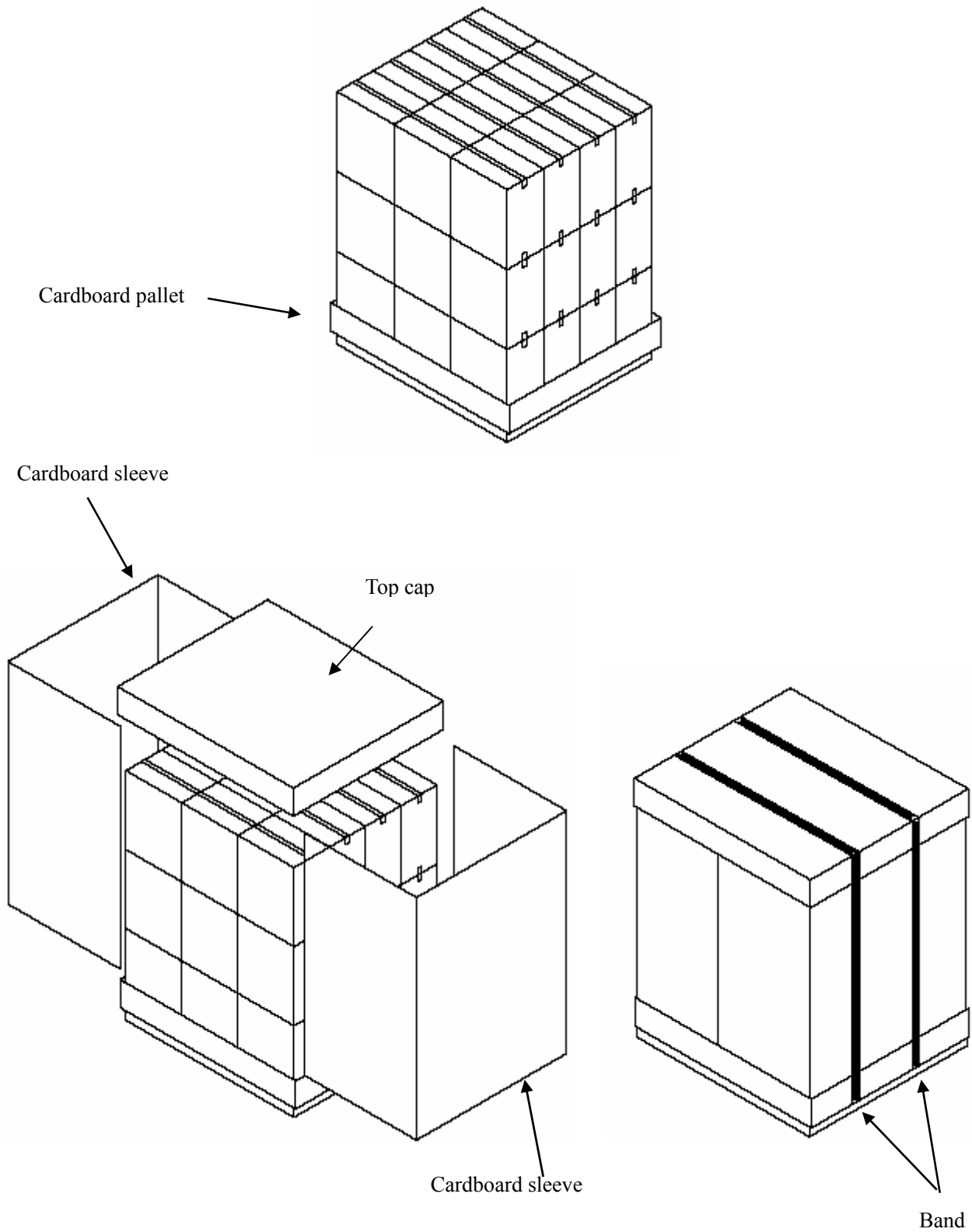

8. PRECAUTIONS

8.1 MEANING OF CAUTION SIGNS

The following caution signs have very important meaning **.Be sure to read “10.2 CAUTIONS” and “10.3 ATTENTIONS”, after understanding these contents!**



This sign has the meaning that customer will be injured by himself or the product will sustain a damage, if customer has wrong operations.



This sign has the meaning that customer will get an electrical shock, if customer has wrong operations.



This sign has the meaning that customer will be injured by himself, if customer has wrong operations.

8.2 CAUTIONS



* touch lamp cables while turn on .Customers will be in danger of an electric shock



- * Do not touch the working backlight and IC. Customers will be in danger of burn injury.
- * Do not shock and press the LCD panel and the backlight! There is a danger of breaking, because they are made of glass.(shock :To be not greater 294m/s^2 and to be not greater 11ms, Pressure: To be not greater 19.6N)

8.3 ATTENTIONS



8.3.1 Handling of the product

- ① Take hold of both ends without touch the circuit board when customer pulls out products (LCD modules) from inner packing box. If customer touches it, products may be broken down or out of adjustment, because of stress to mounting parts.
- ② Do not hook cables nor pull connection cables such as flexible cable and so on , for fear of damage.
- ③ If customer puts down the product temporarily, the product puts on flat subsoil as a display side turns down.
- ④ Take the measures of electrostatic discharge such as earth band, ionic shower and so on, when customer deal with the product, because products may be damaged by electrostatic.
- ⑤ The torque for mounting screws must never exceed 0.34N-m. Higher torque values might result in distortion of the bezel.
- ⑥ The product must be installed using mounting holes without undue stress such as bends or twist (See outline drawings). And do not add undue stress to any portion (such as bezel flat area) except mounting hole portion.

Bends or twist described above and undue stress to any portion except mounting hole portion may cause display un-uniformity.

- ⑦ Do not press or rub on the sensitive display surface .If customer clean on the panel surface, SVA-NEC recommends using the cloth with ethanolic liquid such as screen cleaner for LCD.
- ⑧ Do not push-pull the interface connectors while the product is working, because wrong power sequence may break down the product.
- ⑨ Do not bend or unbend the lamp cable at the near part of the lamp holding rubber, to avoid the damage for high voltage side of the lamp. This damage may cause a lamp breaking and abnormal operation of high voltage circuit.

8.3.2 Environment

- ① Do not operate or store in high temperature, high humidity, dewdrop atmosphere or corrosive gases. Keep the product in antistatic pouch in room temperature, because of avoidance for dusts and sunlight, if customer stores the product.
- ② In order to prevent dew condensation occurring by temperature difference, the product packing box must be opened after leave under the environment of an unpacking room temperature enough. Because a situation of dew condensation occurring is changed by the environment temperature and humidity, evaluate the leaving time sufficiently. (Recommendation leaving time: 6 hour or more with packing state)
- ③ Do not operate in a high magnetic field .Circuit boards may be broken down by it.
- ④ This product is not designed as radiation hardened.
- ⑤ Use an original protection sheet on the product surface (polarizer). Adhesive type protection sheet should be avoided, because it may change color or properties of the polarizer.

8.3.3 Characteristics

The following items are neither defects nor failures.

- ① Response time, luminance and color may be changed by ambient temperature.
- ② The LCD may be seemed luminance non-uniformity, flicker, vertical seam or small spot by display patterns.
- ③ Optical characteristics (e.g. luminance, display uniformity, etc.) gradually is going to change depending on operating time ,and especially low temperature, because the LCD has cold cathode fluorescent lamps.
- ④ Do not display the fixed pattern for a long time because it may cause image sticking .Use a screen saver, if the fixed pattern is displayed on the screen.
- ⑤ The display color may be changed by viewing angle because of the use of condenser sheet in the backlight.
- ⑥ Optical characteristics may be changed by input signal timings.
- ⑦ The interference noise of input signal frequency for this product and luminance control frequency of customer's backlight inverter may appear on a display. Set up luminance control frequency of backlight inverter so that the interference noise does not appear.

8.3.4 Other



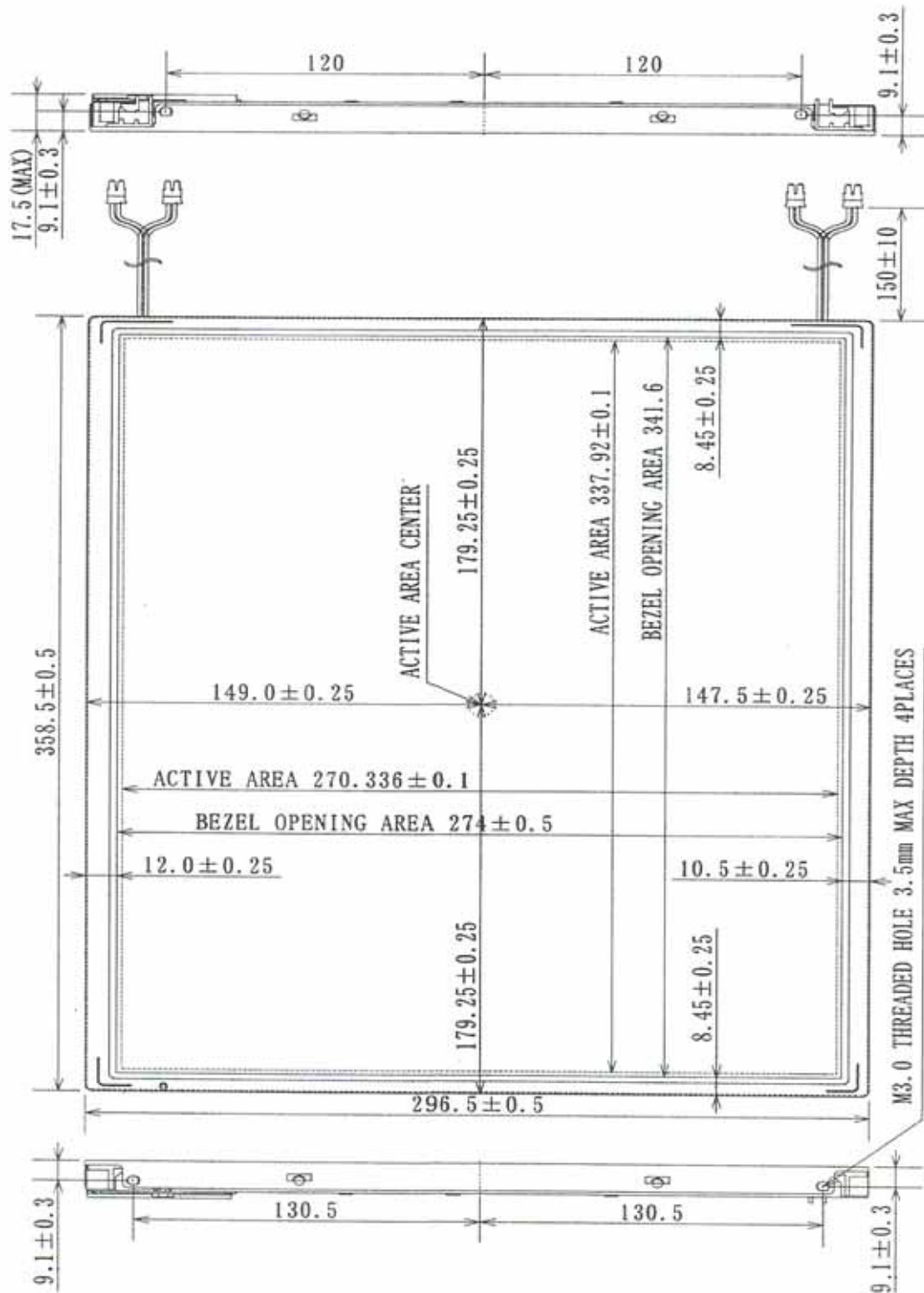

- ① All GND and VCC terminals should be used without a non-connected line.
- ② Do not disassemble a product or adjust volume without permission of SVA-NEC.
- ③ See "REPLACEMENT MANUAL FOR LAMPHOLDER SET", if customer would like to replace backlight lamps.
- ④ Pay attention not to insert waste materials inside of products, if customer uses screw nails.
- ⑤ Pack the product with original shipping package, because of avoidance of some damages during transportation, when customer returns it to SVA-NEC for repair and so on .
- ⑥ Not only the module but also the equipment should be packed and transported as the module. becomes vertical .Otherwise, there is the fear that a display dignity decreases by an impact or vibrations.

9. OUTDRAWING

9.1 FRONT VIEW



NOTE: NOT MARKED TOLERANCES IN THE FIGURE ARE ± 0.5mm

Rev	Revised date	Main Revision item and sign	Approved by	Checked by	Prepared by	Published date																									
1.0		<table border="1"> <tr> <td rowspan="4" style="writing-mode: vertical-rl; text-orientation: upright;">s i g n</td> <td>品</td> <td>营</td> <td></td> <td></td> <td></td> <td></td> </tr> <tr> <td>一</td> <td>吴昌树</td> <td></td> <td></td> <td></td> <td></td> </tr> <tr> <td>户</td> <td></td> <td></td> <td></td> <td></td> <td></td> </tr> <tr> <td></td> <td></td> <td></td> <td></td> <td></td> <td></td> </tr> </table>	s i g n	品	营					一	吴昌树					户												S.okabe	S.okabe	Yang Gang 2005.7.25	2005.7.25
s i g n	品	营																													
	一	吴昌树																													
	户																														
2.0	2005.10.28	<table border="1"> <tr> <td rowspan="4" style="writing-mode: vertical-rl; text-orientation: upright;">s i g n</td> <td>品</td> <td>营</td> <td></td> <td></td> <td></td> <td></td> </tr> <tr> <td>一</td> <td>孙亚伟</td> <td></td> <td></td> <td></td> <td></td> </tr> <tr> <td>户</td> <td></td> <td></td> <td></td> <td></td> <td></td> </tr> <tr> <td></td> <td></td> <td></td> <td></td> <td></td> <td></td> </tr> </table> <p>NOTE: The total response time (Ton+Toff) (typ.) is changed to 8ms.(P4,P5,P19)</p>	s i g n	品	营					一	孙亚伟					户												S.okabe	S.okabe	Yang Gang 2005.10.28	2005.10.28
s i g n	品	营																													
	一	孙亚伟																													
	户																														
3.0	2005.11.1	<table border="1"> <tr> <td rowspan="4" style="writing-mode: vertical-rl; text-orientation: upright;">s i g n</td> <td>品</td> <td>营</td> <td></td> <td></td> <td></td> <td></td> </tr> <tr> <td>一</td> <td></td> <td></td> <td></td> <td></td> <td></td> </tr> <tr> <td>户</td> <td></td> <td></td> <td></td> <td></td> <td></td> </tr> <tr> <td></td> <td></td> <td></td> <td></td> <td></td> <td></td> </tr> </table> <p>NOTE: The product's package specification is added.(P28~30)</p>	s i g n	品	营					一						户														Yang Gang 2005.11.1	
s i g n	品	营																													
	一																														
	户																														