

Shanghai SVA - NEC Liquid Crystal Display Co., Ltd.

TFT COLOR LCD MODULE

(COMMON)

SVA190WX02TB

48cm (19.0W Type)

WXGA+

LVDS Interface (2port)

(Version 2.0)

Published by

Product Management Department
SVA - NEC Liquid Crystal Display Co., Ltd.

Approved by _____ *Date* _____

Pei Ying Chen _____ *2007. 3. 29*

Checked by _____ *Date* _____

J. Kai _____ *2007. 3. 29*

Prepared by _____ *Date* _____

Shu Bin _____ *2007. 3. 29*

Signature of customer

Confirmed by _____ *Date* _____

INTRODUCTION

• WARRANTY

Shanghai SVA NEC Liquid Crystal Display Co., Ltd. (hereinafter called "SVA-NEC") warrants that this product meets the product specifications set forth in this document. If this product under normal operation is found to be non-conforming to the product specifications, and such non-conformance is promptly notified to SVA-NEC within one (1) year after the delivery date, and further such non-conformance is solely attributable to SVA-NEC, SVA-NEC shall repair the non-conforming product or replace it with a conforming one, free of charge. However, this warranty does not apply to any non-conformance that can be found easily by incoming inspections or those resulting from any one of the following:

- 1) Unauthorized or improper repair, maintenance or modification
- 2) Operation or use against specifications, instructions or warnings given by SVA-NEC
- 3) Any other causes attributable to customer

In case SVA-NEC repairs or replaces a product after the one (1)-year warranty period, SVA-NEC shall be entitled to charge for such repair or replacement. Those replaced parts shall be covered with six (6)-month warranty period from the replacement day. Non-conforming products may be replaced with substitutes instead of repair when the manufacture of this product has been terminated.

EXCEPT AS EXPRESSLY SET FORTH HEREIN, SVA-NEC DISCLAIMS ANY WARRANTIES, EXPRESS OR IMPLIED, INCLUDING BUT NOT LIMITED TO MERCHANTABILITY AND FITNESS FOR A PARTICULAR PURPOSE, AND DISCLAIMS ANY REMEDIES.

• MAINTENANCE

The specifications of maintenance parts may be partially changed within equivalent quality or better. In this product, SVA-NEC will not accept to maintain for only mounting parts on circuit board (e.g. connector, fuse, capacitor, resistor, etc.) and only backlight conformation parts (e.g. reflector sheet, light guide plate, etc.).

If SVA-NEC is planning discontinuation for this product, SVA-NEC shall inform it to customers in six (6)-months advance from the issued date of official agreements. In addition, after product discontinuation, SVA-NEC may replace substitutes instead of maintenance parts with whole product.

• CHANGE CONTROL

For the purpose of product improvement, this product design may be changed for specifications, appearance, parts, circuits and so on. In case a design change is affected on the product specifications, SVA-NEC shall inform it to customers in advance.

• HANDLING OF DOUBTFUL POINTS

Any question arising out of, or in connection with, this SPECIFICATION or any matter not stipulated herein will be settled each time upon consultation between both parties.

CONTENTS

INTRODUCTION	2
CONTENTS	3
1. OUTLINE	4
1.1 STRUCTURE AND PRINCIPLE	4
1.2 APPLICATIONS	4
1.3 FEATURES	4
2. GENERAL INFORMATION	5
3. BLOCK DIAGRAM	6
4. DETAILED SPECIFICATION	7
4.1 MECHANICAL SPECIFICATIONS	7
4.2 ABSOLUTE MAXIMUM RATINGS	7
4.3 ELECTRICAL CHARACTERISTICS	8
4.4 POWER SUPPLY VOLTAGE SEQUENCE AND RIPPLE	9
4.5 INTERFACE AND CONNECTOR PIN ALIGNMENT	12
4.6 LVDS I/F DATA CHART	14
4.7 DISPLAY COLORS AND INPUT DATA SIGNALS	16
4.8 INTERFACE TIMING	17
4.9 OPTICS	20
4.10 DEFECT CRITERIA	23
5. RELIABILITY TESTS	27
6. ESTIMATED LUMINANCE LIFETIME	28
7. MARKINGS	29
7.1 PRODUCT LABEL	29
7.2 BARCODE LABEL	29
7.3 OTHER MARKINGS	29
7.4 INDICATION LOCATIONS	30
8. PACKING, TRANSPORTATION AND DELIVERY	31
8.1 PACKING	31
8.2 INSPECTION RECORD SHEET	31
8.3 TRANSPORTATION	31
8.4 SIZE AND WEIGHT FOR PACKING BOX	31
8.5 OUTLINE FIGURE FOR PACKING	32
9. PRECAUTIONS	34
9.1 MEANING OF CAUTION SIGNS	34
9.2 CAUTIONS	34
9.3 ATTENTIONS	34
10. OUTDRAWING	36
10.1 FRONT VIEW	36
10.2 REAR VIEW	37

1. OUTLINE

1.1 STRUCTURE AND PRINCIPLE

SVA190WX02TB module is composed of the amorphous silicon thin film transistor liquid crystal display (a-Si TFT LCD) panel structure with driver LSIs for driving the TFT (Thin Film Transistor) array and a backlight.

The a-Si TFT LCD panel structure is injected liquid crystal material into a narrow gap between the TFT array glass substrate and a color-filter glass substrate.

Color (Red, Green, Blue) data signals from a host system (e.g. PC, signal generator, etc.) are modulated into best form for active matrix system by a signal processing board, and sent to the driver LSIs which drive the individual TFT arrays.

The TFT array as an electro-optical switch regulates the amount of transmitted light from the backlight assembly, when it is controlled by data signals. Color images are created by regulating the amount of transmitted light through the TFT array of red, green and blue dots.

1.2 APPLICATIONS

- Monitor for PC

1.3 FEATURES

- a-Si TFT active matrix
- LVDS interface
- R.G.B input 8bit, 16.77 millions colors (6bit+Hi-FRC)
- Resolution WXGA+(1,440×900 pixels)
- Wide viewing angle: 80°/80°(L/R); 80°/80° (U/D)
- High contrast ratio: 800:1
- Module size: 428.0(H) ×278.0(V) ×18.5 (D)mm
- High response time (Ton+Toff=5 ms)
- High gamut: (against NTSC 72%typ.)
- Edge light type backlight (4 CCFL lamps)
- Inverter less

2. GENERAL INFORMATION

Display area	408.24 (H) x 255.15 (V)mm (typ.), [48.0 cm (19.0 inches)]
Drive system	a-Si TFT active matrix
Display color	16.77M colors (6bit+Hi-FRC)
Pixel	1,440 (H) x 900(V) pixels
Pixel arrangement	RGB (Red dot、 Green dot、 Blue dot) vertical stripe
Pixel pitch	0.2835 (W) x 0.2835 (H) mm
Module size	428.0±0.5(H) ×278.0±0.5 (V) ×18.5(D)mm
Weight	2500g (typ.)
Contrast ratio	800:1(typ.)
Viewing angle (At the contrast ratio 10: 1)	<ul style="list-style-type: none"> • Horizontal:80°/80°(L/R); • Vertical: 80°/80° (U/D)
Designed viewing direction	• Viewing angle with optimum grayscale ($\gamma=2.2$): normal axis
Color gamut	At LCD panel center 72 % (typ.) [against NTSC color space]
Response time	Ton (white 90%→black 10%) + Toff (black 10%→white 90%) 5 ms (typ.)
Luminance	At IBL = 6.5Arms / lamp 300cd/m ² (typ.)
Signal system	LVDS 2port [RGB :8-bit, Dot clock (CLK), Data enable (DE)]
Power supply voltage	LCD panel signal processing board: 5.0V
Backlight	Edge light type : 4 cold cathode fluorescent lamps (Inverter less)
Power consumption	At IBL=6.5Arms / lamp and checkered flag pattern 22 W (typ.)

3. BLOCK DIAGRAM

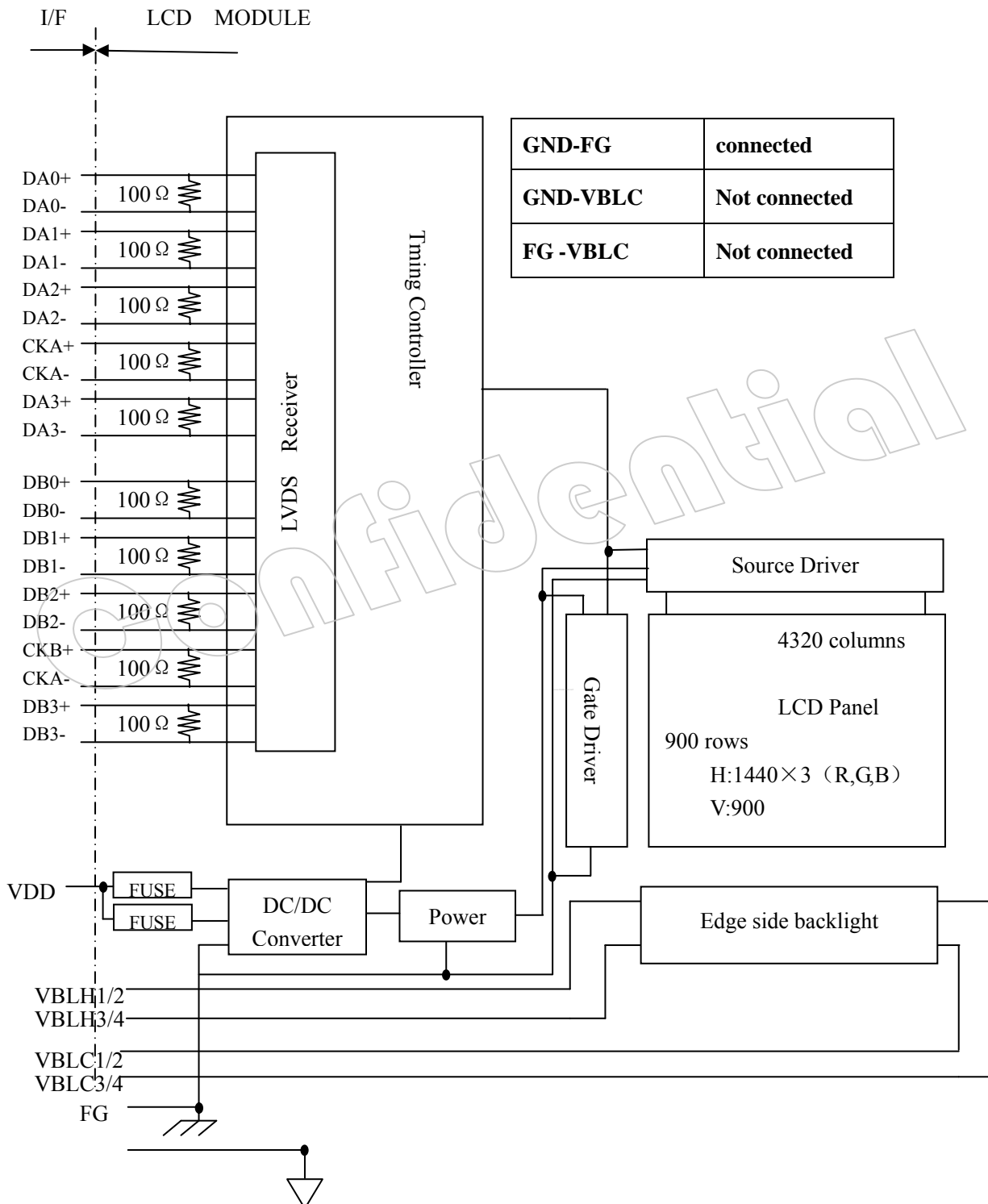

Note: System ground(GND), FG (Frame ground) in the product should be connected together in customer equipment.

4. DETAILED SPECIFICATION

4.1 MECHANICAL SPECIFICATIONS

Parameter	Specification	Unit
Module size	428.0± 0.5 (W) × 278.0 ± 0.5 (H) × 18.5 ± 0.5 (D)	mm
Display area	408.24H) x 255.15 (V) mm (typ.), [48.0 cm (19.0 inches)]	mm
Display dot number	1440×3(H) ×900(V)	-
Pixel pitch	0.2835(H)×0.2835(V)	mm
Dot pitch	0.0945(H) ×0.2835(H)	mm
Color arrangement	RGB (Red dot、 Green dot、 Blue dot) vertical stripe	-
Display color	16,777,216(6bit+Hi FRC)	color
Weight	2500 (typ.)	g

4.2 ABSOLUTE MAXIMUM RATINGS

Parameter		Symbol	Rating	Unit	Remarks
Power supply voltage	Power voltage	VDD	-0.3 ~+6.0	V	Ta = 25°C
	Lamp voltage	VBLH	620~750	Vrms	Ta = 25°C
Lamp current		IBL	3.0~8.0	mA rms	Ta = 25°C, for each lamp
Lamp Oscillation frequency		FO	30~80	kHz	Ta = 25°C
Input voltage for signals		VI	-0.3~2.7	V	Ta = 25°C Note1
Storage temperature		Tst	-20 ~ +60	°C	-
Operating temperature	Front surface	TopF	0 ~ +50	°C	Note2
	Rear surface	TopR	0 ~ TBD	°C	Note3
Relative humidity Note4	RH	≤95	%	Ta ≤40° C	
		≤85		40° C < Ta ≤50° C	
Absolute humidity Note4	AH	≤70 Note5	g/m3	Ta > 50° C	
Operating altitude		-	≤4, 850	m	0° C ≤ Ta ≤ 55° C
Storage altitude		-	≤13, 600	m	-20° C ≤ Ta ≤ 60° C

Note1: Display signals are DA0+/-, DA1+/-, DA2+/-, DA3+/-, CKA+/-, DB0+/-, DB1+/-, DB2+/-, DB3+/-, and CKB+/-.

Note2: Measured at center of LCD panel surface (including self-heat)

Note3: Measured at center of LCD module's rear shield surface (including self-heat)

Note4: No condensation

Note5: Ta = 50°C, RH = 85%

4.3 ELECTRICAL CHARACTERISTICS

4.3.1 Driving for LCD panel signal processing board

(Ta=25°C)

Parameter	Symbol	min.	typ.	max.	Unit	Remarks	
Power supply voltage	VDD	4.5	5.0	5.5	V	-	
Power supply current	IDD	-	800 Note1	950 Note2	mA	at VDD = 5.0V	
Permissible ripple voltage	VRP	-	-	200	mV	VDD	
Differential input threshold voltage for LVDS receiver	Low	VTL	-100	-	-	mV	at VCM = 1.2V Note3
	High	VTH	-	-	+100	mV	
Input voltage width for LVDS receiver	VI	0	-	2.7	V	-	
Terminal resistor	RT	-	100	-	Ω	-	

Note1: Checked flag pattern (EIAJ ED-2522)

Note2: Pattern for maximum current (2H1V dot inverse, 0/15 scale)

Note3: Common mode voltage for LVDS driver

4.3.2 Driving for backlight lamp

(Ta=25°C) Note1

Parameter	Symbol	min.	typ.	max.	Unit	Remarks
Lamp voltage	VBLH	-	680	-	Vrms	Note2、 Note3
Lamp current	IBL	3.0	6.5	8.0	mA rms	Note3
Lamp starting voltage (discharge stabilization voltage)	Vs	1125	-	-	Vrms	Ta = 25°C Note2、 Note3
		1350	-	-	Vrms	Ta =0°C Note2、 Note3
Lamp oscillation frequency	FO	30	50	80	kHz	Note4

Note1: The backlight of this product is made up of 4-piece lamp. The specification above is only for one lamp.

Note2: The voltage timing cycle of each lamp should be set as the same phase. [Vs] and [VBLH] is the voltage between the high port and low port, the value is the characteristic of lamp. The starting voltage of inverter should be higher than the value. The possibility of not lighting exists by the lower voltage, so the suitable voltage should be considered by the test.

Note3: The asymmetric ratio of working waveform for lamps (Lamp voltage peak ratio, Lamp current peak ratio and waveform area ratio) should be less than 5% (See the following figure). If the waveform is asymmetric, DC (Direct current) element applies into the lamp. In this case, a lamp lifetime may be shortened, because a distribution of a lamp enclosure substance inclines toward one side between low voltage terminal (Cold terminal) and high voltage terminal (Hot terminal).

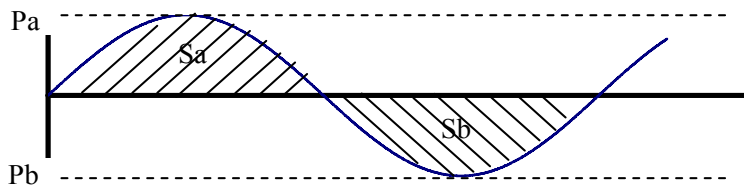

$$|Pa - Pb| / Pb \times 100 \leq 5\%$$

$$|Sa - Sb| / Sb \times 100 \leq 5\%$$

Pa: Supply voltage/current peak for positive, Pb: Supply voltage/current peak for negative

Sa: Waveform space for positive part, Sb: Waveform space for negative part

Note4: In case “FO” is not the recommended value, beat noise may display on the screen, because of interference between “FO” and “1/th”. Recommended value of “FO” is as following.

$$FO = 1/4 \times 1/th \times (2n-1)$$

Th: Horizontal signal period(See “4. 8.1 Timing characteristics”).

n: Natural number (1, 2, 3

4.4 POWER SUPPLY VOLTAGE SEQUENCE AND RIPPLE

4.4.1 Power supply voltage sequence

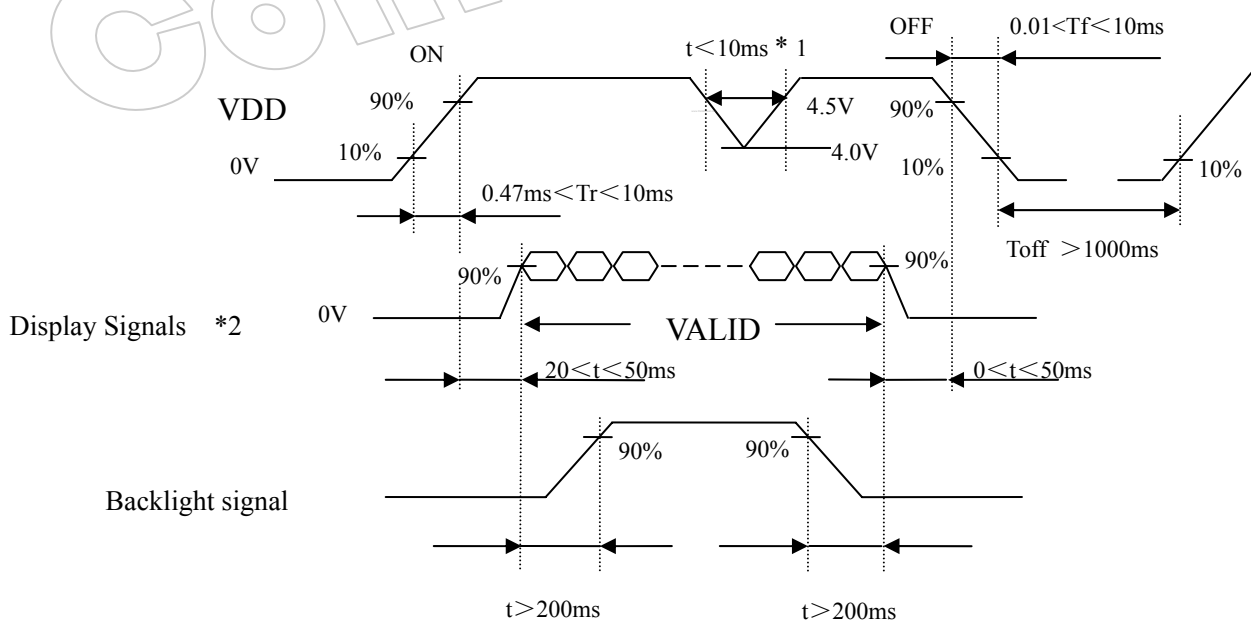

*1. When VDD is on, but the value is lower than 4.5V, a protection circuit may work, then the module may not display.

*2 The signal line is not connected with the module, at the end of cable the terminal resistor of 100Ω should be added.

Note1: Display signals (D0+/-, D1+/-, D2+/-, D3+/- and CK+/-) must be “0” voltage, exclude the VALID period (See above sequence diagram). If these signals are higher than 0.3 V, the internal circuit is damaged.

If some of display signals of this product are cut while this product is working, even if the signal input to it once again, it might not work normally. If customer stops the display signals, they should cut

VDD.

Note2: When VDD is on, it should be set above 4.0V.

Note3: The backlight power supply voltage should be inputted within the valid period of display and function signals, in order to avoid unstable data display.

4.4.2 Power supply voltage ripple

When the power supply is designed, the next form can give the reference. If the voltage ripple is over the value in next form, the noise should be seen in display area.

Ripple (Measured at input terminal of power supply)

	VDD(5V to drive the panel)
Ripple voltage	≤200mVP-P (Including spike noise)

4.4.3 Fuse

Parameter	Fuse		Rating	Fusing current	Remarks
	Type	Supplier			
VDD	FCC16162ADTP	KAMAYA	1.6A 32V	4.0 A	

Note1: There are different power supply systems from the power input terminal. The power supply capacity should be less than the fusing current. If the power supply capacity is above the fusing current, the fuse may blow in a short time, and then nasty smell, smoking and so on may occur.

4.4.4 Connectors for power supply and signals

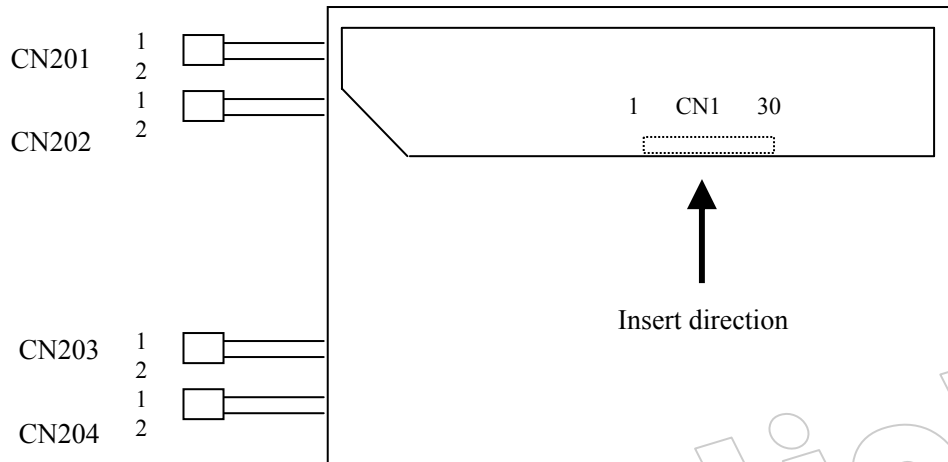

Confidential

4.5 INTERFACE AND CONNECTOR PIN ALIGNMENT

CN1: FI-X30SSL-HF (Produced by JAE) or equivalent.

Pin	Name	Description
1	RXO0-	Negative LVDS differential data input. Channel O0 (odd)
2	RXO0+	Positive LVDS differential data input. Channel O0 (odd)
3	RXO1-	Negative LVDS differential data input. Channel O1 (odd)
4	RXO1+	Positive LVDS differential data input. Channel O1 (odd)
5	RXO2-	Negative LVDS differential data input. Channel O2 (odd)
6	RXO2+	Positive LVDS differential data input. Channel O2 (odd)
7	GND	Ground
8	RXOC-	Negative LVDS differential clock input. (odd)
9	RXOC+	Positive LVDS differential clock input. (odd)
10	RXO3-	Negative LVDS differential data input. Channel O3(odd)
11	RXO3+	Positive LVDS differential data input. Channel O3 (odd)
12	RXE0-	Negative LVDS differential data input. Channel E0 (even)
13	RXE0+	Positive LVDS differential data input. Channel E0 (even)
14	GND	Ground
15	RXE1-	Negative LVDS differential data input. Channel E1 (even)
16	RXE1+	Positive LVDS differential data input. Channel E1 (even)
17	GND	Ground
18	RXE2-	Negative LVDS differential data input. Channel E2 (even)
19	RXE2+	Positive LVDS differential data input. Channel E2 (even)
20	RXEC-	Negative LVDS differential clock input. (even)
21	RXEC+	Positive LVDS differential clock input. (even)
22	RXE3-	Negative LVDS differential data input. Channel E3 (even)
23	RXE3+	Positive LVDS differential data input. Channel E3 (even)
24	GND	Ground
25	GND	Ground
26	NC	Not connection.
27	GND	Ground
28	VCC	+5.0V power supply
29	VCC	+5.0V power supply
30	VCC	+5.0V power supply

CN1: The inserting side is as follows

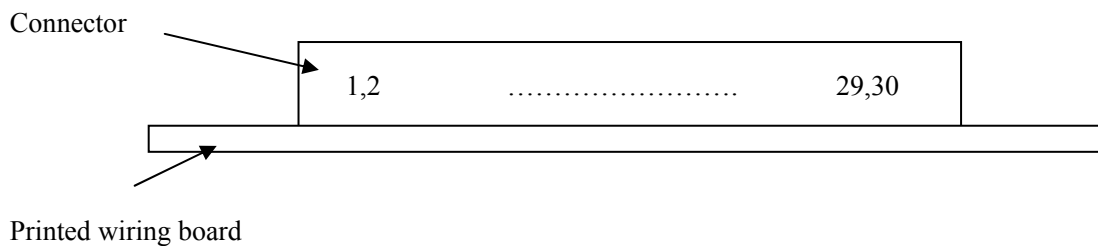

CN201: BHSR-02VS-1 (J.S.T Mfg. Co., Ltd.)

Adaptable connector: SM02B-BHSS-1-TB (J.S.T. Mfg Co., Ltd.)

Pin No.	Signal name	Function
1	VH1	High voltage input terminal for upper lamp(Cable color: Blue)
2	VL1	Low voltage input terminal for upper lamp(Cable color: Black)

CN202: BHSR-02VS-1 (J.S.T Mfg. Co., Ltd.)

Adaptable connector: SM02B-BHSS-1-TB (J.S.T. Mfg Co., Ltd.)

Pin No.	Signal name	Function
1	VH2	High voltage input terminal for upper lamp(Cable color: Pink)
2	VL2	Low voltage input terminal for upper lamp(Cable color: White)

CN203 : BHSR-02VS-1 (J.S.T Mfg. Co., Ltd.)

Adaptable connector: SM02B-BHSS-1-TB (J.S.T. Mfg Co., Ltd.)

Pin No.	Symbol name	Function
1	VH3	High voltage input terminal for lower lamp(Cable color: Blue)
2	VL3	Low voltage input terminal for lower lamp(Cable color: Black)

CN204: BHSR-02VS-1 (J.S.T Mfg. Co., Ltd.)

Adaptable connector: SM02B-BHSS-1-TB (J.S.T. Mfg Co., Ltd.)

Pin No.	Symbol name	Function
1	VH4	High voltage input terminal for lower lamp(Cable color: Pink)
2	VL4	Low voltage input terminal for lower lamp(Cable color: White)

Note1: The ports of VDD and GND should be all used. As for the input of LVDS, please use the twisted pair wire of the transmission impedance 100Ω.

Note2: System ground (GND), FG (Frame ground) and VBLC (Lamp low voltage terminal) in the product should be connected together in customer equipment.

4.6 LVDS I/F DATA CHART

Input DATA		Transmitter		CN1				
		pin	DS90CF383,C385 or equivalent					
Odd pixel data and control signals	RA0	→ 51	TXIN0			pin	Symbol	
	RA1	→ 52	TXIN1	TA1-	→ 1	DA0-		
	RA2	→ 54	TXIN2	TA1+	→ 2	DA0+		
	RA3	→ 55	TXIN3					
	RA4	→ 56	TXIN4	TB1-	→ 3	DA1-		
	RA5	→ 3	TXIN6	TB1+	→ 4	DA1+		
	GA0	→ 4	TXIN7					
	GA1	→ 6	TXIN8	TC1-	→ 5	DA2-		
	GA2	→ 7	TXIN9	TC1+	→ 6	DA2+		
	GA3	→ 11	TXIN12		→ 7	GND		
	GA4	→ 12	TXIN13	TCLK1-	→ 8	CKA-		
	GA5	→ 14	TXIN14	TCLK1+	→ 9	CKA+		
	BA0	→ 15	TXIN15					
	BA1	→ 19	TXIN18	TD1-	→ 10	DA3-		
	BA2	→ 20	TXIN19	1 ST TD1+	→ 11	DA3+		
	BA3	→ 22	TXIN20					
	BA4	→ 23	TXIN21					
	BA5	→ 24	TXIN22					
	RSVD	→ 27	TXIN24					
	RSVD	→ 28	TXIN25					
	DE	→ 30	TXIN26					
	RA6	→ 50	TXIN27					
	RA7	→ 2	TXIN5					
	GA6	→ 8	TXIN10					
	GA7	→ 10	TXIN11					
	BA6	→ 16	TXIN16					
	BA7	→ 18	TXIN17					
	RSVD	→ 25	TXIN23					
	CLK	→ 31	CLKIN					
	Even pixel data	RB0	→ 51	TXIN0				
		RB1	→ 52	TXIN1	TA2-	→ 12	DB0-	
RB2		→ 54	TXIN2	TA2+	→ 13	DB0+		
RB3		→ 55	TXIN3		→ 14	GND		
RB4		→ 56	TXIN4	TB2-	→ 15	DB1-		
RB5		→ 3	TXIN6	TB2+	→ 16	DB1+		
GB0		→ 4	TXIN7		→ 17	GND		
GB1		→ 6	TXIN8	TC2-	→ 18	DB2-		
GB2		→ 7	TXIN9	TC2+	→ 19	DB2+		
GB3		→ 11	TXIN12					
GB4		→ 12	TXIN13	TCLK2-	→ 20	CKB-		
GB5		→ 14	TXIN14	TCLK2+	→ 21	CKB+		
BB0		→ 15	TXIN15					
BB1		→ 19	TXIN18	TD2-	→ 22	DB3-		
BB2		→ 20	TXIN19	2 nd TD2+	→ 23	DB3+		
BB3		→ 22	TXIN20		→ 24	GND		
BB4		→ 23	TXIN21		→ 25	GND		
BB5		→ 24	TXIN22		→ 26	NC		
RSVD		→ 27	TXIN24		→ 27	GND		
RSVD		→ 28	TXIN25		→ 28	VDD		
RSVD		→ 30	TXIN26		→ 29	VDD		
RB6		→ 50	TXIN27		→ 30	VDD		
RB7		→ 2	TXIN5					
GB6		→ 8	TXIN10					
GB7		→ 10	TXIN11					
BB6		→ 16	TXIN16					
BB7		→ 18	TXIN17					
RSVD		→ 25	TXIN23					
CLK		→ 31	CLKIN					

Note1: The lowest bit (RA0, GA0, BA0, RB0, GB0, BB0), the most upper bit (RA7, GA7, BA7, RB7, GB7, BB7)

Note2: Connecting cable between LCD panel's connector and transmitter should use 100 Ω twisted line.

Note3: Though "RSVD" of input data is not used, do not keep open in order to prevent the noise.

Note4: If only Hsync and Vsync, the product don't work. Make sure DE signal has been input.

Confidential

4.7 DISPLAY COLORS AND INPUT DATA SIGNALS

This product can display in equivalent to 16,777,216 colors in 256 scales. Also the relation between display colors and input data signals is as the following table.

Display colors		Data signal (0:Low level 、 1:High Level)																							
		RA7	RA6	RA5	RA4	RA3	RA2	RA1	RA0	GA7	GA6	GA5	GA4	GA3	GA2	GA1	GA0	BA7	BA6	BA5	BA4	BA3	BA2	BA1	BA0
		RB7	RB6	RB5	RB4	RB3	RB2	RB1	RB0	GB7	GB6	GB5	GB4	GB3	GB2	GB1	GB0	BB7	BB6	BB5	BB4	BB3	BB2	BB1	BB0
Basic color	Black	0	0	0	0	0	0	0	0	0	0	0	0	0	0	0	0	0	0	0	0	0	0	0	0
	Blue	0	0	0	0	0	0	0	0	0	0	0	0	0	0	0	0	1	1	1	1	1	1	1	1
	Red	1	1	1	1	1	1	1	1	0	0	0	0	0	0	0	0	0	0	0	0	0	0	0	0
	Magenta	1	1	1	1	1	1	1	1	0	0	0	0	0	0	0	0	1	1	1	1	1	1	1	1
	Green	0	0	0	0	0	0	0	0	1	1	1	1	1	1	1	1	0	0	0	0	0	0	0	0
	Cyan	0	0	0	0	0	0	0	0	1	1	1	1	1	1	1	1	1	1	1	1	1	1	1	1
	Yellow	1	1	1	1	1	1	1	1	1	1	1	1	1	1	1	1	0	0	0	0	0	0	0	0
	White	1	1	1	1	1	1	1	1	1	1	1	1	1	1	1	1	1	1	1	1	1	1	1	1
Red scale	Black	0	0	0	0	0	0	0	0	0	0	0	0	0	0	0	0	0	0	0	0	0	0	0	0
		0	0	0	0	0	0	0	1	0	0	0	0	0	0	0	0	0	0	0	0	0	0	0	0
	Dark	0	0	0	0	0	0	1	0	0	0	0	0	0	0	0	0	0	0	0	0	0	0	0	0
	↑																								
	↓																								
	Bright	1	1	1	1	1	1	0	1	0	0	0	0	0	0	0	0	0	0	0	0	0	0	0	0
	1	1	1	1	1	1	1	0	0	0	0	0	0	0	0	0	0	0	0	0	0	0	0	0	
Red	1	1	1	1	1	1	1	1	0	0	0	0	0	0	0	0	0	0	0	0	0	0	0	0	
Green scale	Black	0	0	0	0	0	0	0	0	0	0	0	0	0	0	0	0	0	0	0	0	0	0	0	0
		0	0	0	0	0	0	0	0	0	0	0	0	0	0	0	1	0	0	0	0	0	0	0	0
	Dark	0	0	0	0	0	0	0	0	0	0	0	0	0	0	1	0	0	0	0	0	0	0	0	0
	↑																								
	↓																								
	Bright	0	0	0	0	0	0	0	0	1	1	1	1	1	1	0	1	0	0	0	0	0	0	0	0
	0	0	0	0	0	0	0	0	1	1	1	1	1	1	1	0	0	0	0	0	0	0	0	0	
Green	0	0	0	0	0	0	0	0	1	1	1	1	1	1	1	1	0	0	0	0	0	0	0	0	
Blue scale	Black	0	0	0	0	0	0	0	0	0	0	0	0	0	0	0	0	0	0	0	0	0	0	0	0
		0	0	0	0	0	0	0	0	0	0	0	0	0	0	0	0	0	0	0	0	0	0	0	1
	Dark	0	0	0	0	0	0	0	0	0	0	0	0	0	0	0	0	0	0	0	0	0	0	1	0
	↑																								
	↓																								
	Bright	0	0	0	0	0	0	0	0	0	0	0	0	0	0	0	0	1	1	1	1	1	1	0	1
	0	0	0	0	0	0	0	0	0	0	0	0	0	0	0	0	1	1	1	1	1	1	1	0	
Blue	0	0	0	0	0	0	0	0	0	0	0	0	0	0	0	0	1	1	1	1	1	1	1	1	

Note: Combination with 8 bit (256 grayscale) R,G,B color signal , the color can be formed.

4.8 INTERFACE TIMING

4.8.1 Timing specification

Parameter		Symbol	min.	typ.	max.	Unit	Remarks
Clock	Frequency	1/tc	34.4	44.45	74.25	MHz	LVDS transmitter input
		tc	29.07	22.50	13.47	ns	
	Rise time, Fall time	-	Refer to the timing characteristics of LVDS transmitter			ns	-
	Duty	-				-	-
Horizontal signals	Cycle	th	148	18.0	26.5	μs	55.5kHz(typ.)
			754	800	900	CLK	
	Display period	thd	720			CLK	-
Vertical signals	Cycle	tv	133	1667	20	ms	60.0Hz(typ.)
			912	926	1100	H	
	Display period	tvd	900			H	-
DE/Data	Setup time	-	Refer to the timing characteristics of LVDS transmitter			ns	-
	Hold time	-				ns	-
	Rise time, Fall time	-				ns	-

4.8.2 Input signal timing chart

Horizontal timing

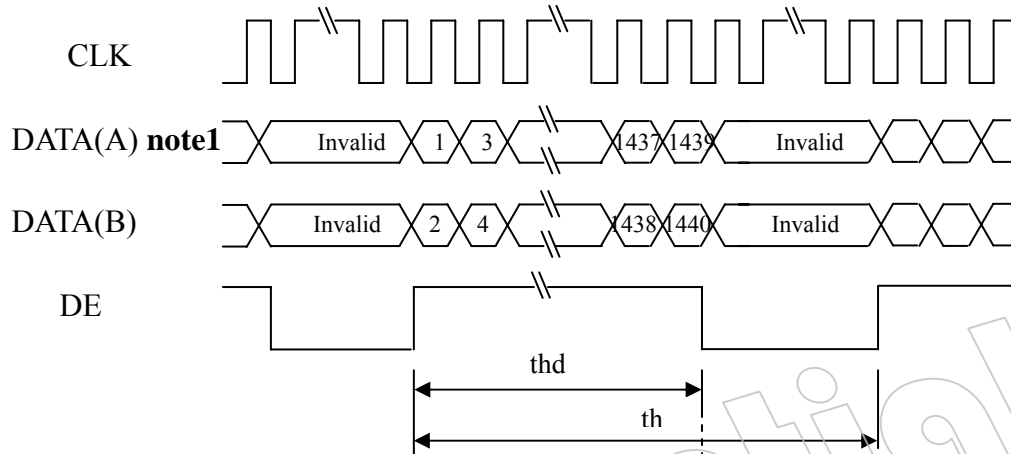

Vertical timing

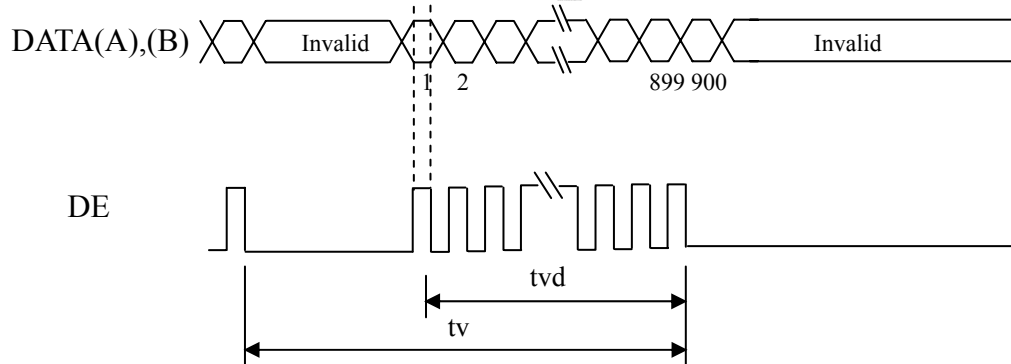

Note 1: DATA(A)=RA0-RA7,GA0-GA7,BA0-BA7

DATA(B)=RB0-RB7,GB0-GB7,BB0-BB7

4.8.3 Pixel DATA alignment of display image

The following chart is the coordinates of per pixel

Odd Pixel: RA= R DATA Even Pixel : RB=R DATA
 GA= G DATA GB=G DATA
 BA= B DATA BB=B DATA

D(1,1)			D(2,1)		
RA	GA	BA	RB	GB	BB

D(1,1)	D(2,1)	D(3,1)	...	D(1440,1)
D(1,2)	D(2,2)	D(3,2)	...	D(1440,2)
D(1,3)	D(2,3)	D(3,3)	...	D(1440,3)
•	•	•	...	•
•	•	•	...	•
•	•	•	...	•
D(1,900)	D(2,900)	D(2,900)	...	D(1440,900)

4.9 OPTICS

4.9.1 Optical characteristics

Note1 ,Note2

Parameter Note1	Condition	Symbol	min.	typ.	max.	Unit	Remarks	
Luminance	White at center $\theta R=0^\circ, \theta L=0^\circ, \theta U=0^\circ, \theta D=0^\circ$	L	250	300	-	cd/ m ²	-	
Contrast ratio	White/Black at center $\theta R=0^\circ, \theta L=0^\circ, \theta U=0^\circ, \theta D=0^\circ$	CR	450	800	-	-	Note3	
Luminance uniformity	White $\theta R=0^\circ, \theta L=0^\circ, \theta U=0^\circ, \theta D=0^\circ$	LU	-	1.25	1.33	-	Note4	
Chromaticity	White	X coordinate	Wx	0.283	0.313	0.343	-	Note5
		Y coordinate	Wy	0.299	0.329	0.359	-	
	Red	X coordinate	Rx	0.621	0.6501	0.681	-	
		Y coordinate	Ry	0.303	0.333	0.363	-	
	Green	X coordinate	Gx	0.267	0.297	0.327	-	
		Y coordinate	Gy	0.572	0.602	0.632	-	
	Blue	X coordinate	Bx	0.112	0.142	0.172	-	
		Y coordinate	By	0.047	0.077	0.107	-	
Color gamut	$\theta R=0^\circ, \theta L=0^\circ, \theta U=0^\circ, \theta D=0^\circ$ At center,against NTSC	C	70	72	-	%		
Response time	White to black	Ton	-	1.3	3	ms	Note6 Note7	
	Black to white	Toff	-	3.7	7	ms		
	Ton+ Toff	-	-	5	10	ms		
Viewing angle	Right	$\theta U=0^\circ, \theta D=0^\circ, CR=10$	θR	70	80	-	Note8	
	Left	$\theta U=0^\circ, \theta D=0^\circ, CR=10$	θL	70	80	-		
	Up	$\theta R=0^\circ, \theta L=0^\circ, CR=10$	θU	70	80	-		
	Down	$\theta R=0^\circ, \theta L=0^\circ, CR=10$	θD	70	80	-		

Note1: The values in upper table are only initial characteristics.

Note2: Measurement conditions are as follows.

Ta=25°C , VDD=5.0V , IBL=6.5mArms/lamp , Display mode : WXGA+ , Horizontal cycle=55.56KHz, Vertical cycle=60.0Hz

Optical characteristics are measured at luminance saturation after 30minutes from working the product in the dark room. Also measurement method for luminance is as follows.

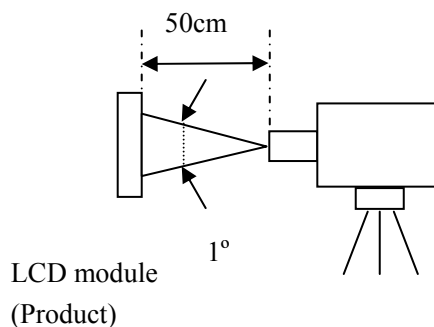

Luminance Meter (TOPCON BM-5A)
Spectroradiometer(TOPCON SR-3)

Note 3: See“4.9.2 Definition of contrast ratio”.

Note 4: See“4.9.3 Definition of luminance uniformity”.

Note 5: CIE 1931 Chromaticity Diagram Standard.

Note 6: Product surface temperature: TopF = 33.0 °C

Note 7: See “4.9.4 Definition of response times”.

Note 8: See “4.9.5 Definition of viewing angles”.

4.9.2 Definition of contrast ratio

The contrast ratio is calculated by using the following formula.

$$\text{Contrast ratio (CR)} = \frac{\text{Luminance of white screen}}{\text{Luminance of black screen}}$$

4.9.3 Definition of luminance uniformity

The luminance uniformity is calculated by using the following formula.

$$\text{Luminance uniformity (LU)} = \frac{\text{Maximum luminance from ① to ⑨}}{\text{Minimum luminance from ① to ⑨}}$$

The luminance is measured at near the 9 points shown below.

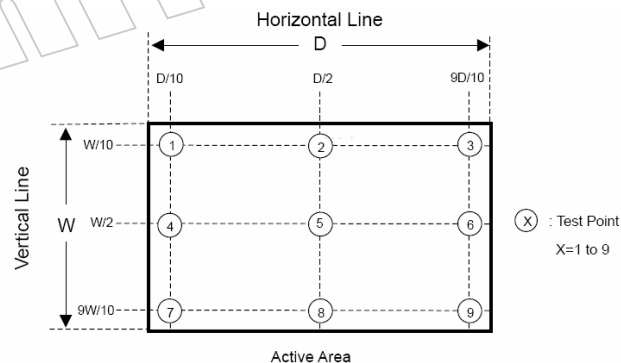

4.9.4 Definition of response times

Response time is measured, the luminance changes from “white” to “black”, or “black” to “white” on the same screen point, by photo-detector. Ton is the time it takes the luminance change from 90% down to 10%. Also Toff is the time it takes the luminance change from 10% up to 90%. (See the following diagram.)

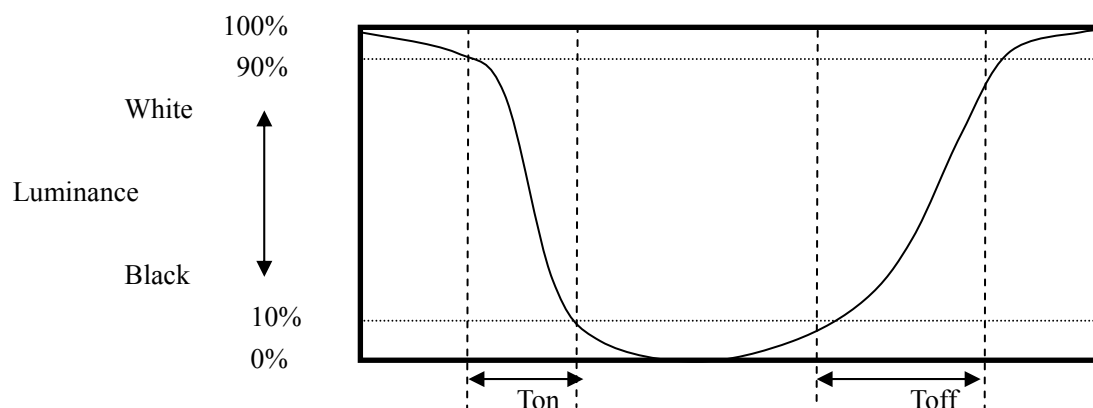

4.9.5 Definition of viewing angle

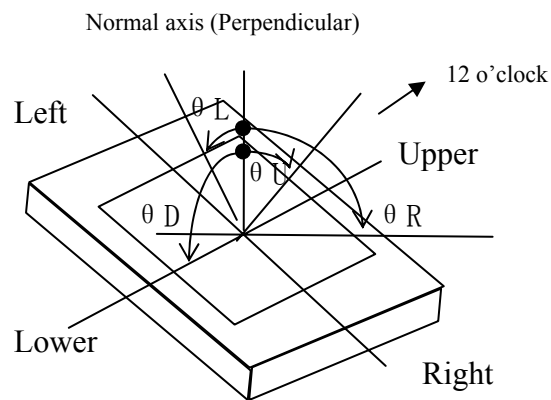

Confidential

4.10 DEFECT CRITERIA

4.10.1 Display specification

(Note1, Note 2)

Defect pattern	Condition		Criteria	
Line defect	Display of black, white, red, green, blue		0 line	
Bright dots Note 2 Note 3	R+G+B		≤ 3 dots	
	Close defect dots Note 6	$15\text{mm} \leq D$ Note 5	Allowed	
	Linked defect dots Note 7	$D=0\text{mm}$ Note 5	2 defect dots	1 set
			3 defect dots or more	0 set
Dark dots Note 2 Note 4	R+G+B		≤ 3 dots	
	Close defect dots Note 6	$15\text{mm} \leq D$ Note 5	Allowed	
	Linked defect dots Note 7	$D=0\text{mm}$ Note 5	2 defect dots	≤ 1 set
			3 defect dots or more	0 set
Total	Bright dots+Dark dots		≤ 5 dots	

Note 1: Inspection conditions are as follows.

Temperature	$25 \pm 5^\circ\text{C}$
Inspection viewing distance	20cm (The distance between the inspector's eye and screen)
Inspection direction	$0^\circ \leq \theta_R \leq 20^\circ$, $0^\circ \leq \theta_L \leq 20^\circ$
	$0^\circ \leq \theta_U \leq 20^\circ$
Inspection illumination	60lx (at a display surface)

Note 2: Defect area $> 1/2$ of one dot

Dot defects are include intermittent bright and dark dot.

Dots darker than half brightness of full bright dots are not defined as bright dot defect, and dots brighter than half brightness of full bright dots are not defined as dark dot defect.

Note 3: Bright dots are counted while the display is black.



Note 4: Dark dots are counted while the display is illuminated with Red, Green or Blue.

Note 5: D is the distance between defect dots.





Note 6: See "4.10.2 Close defect dots".

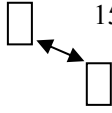
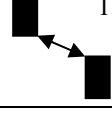
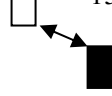

Note 7: See "4.10.3 Linked defect dots".

4.10.2 Close defect dots

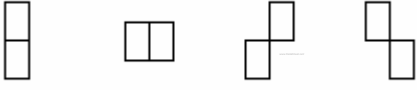
Defect pattern	 : Bright dot  : Dark dot	Criteria
Bright dots	 $15\text{mm} \leq D$	Allowed
Dark dots	 $15\text{mm} \leq D$	Allowed
Combinations between bright dot and dark dot	 $15\text{mm} \leq D$	Allowed

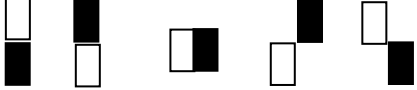
4.10.3 Linked defect dots

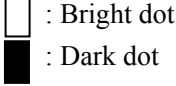
Defect pattern	 : Bright dot  : Dark dot	Criteria
2 defect dots		$\leq 1\text{set}$
		$\leq 1\text{ set}$
	Combination between bright dots and dark dot  Etc.	$\leq 2\text{ sets}$

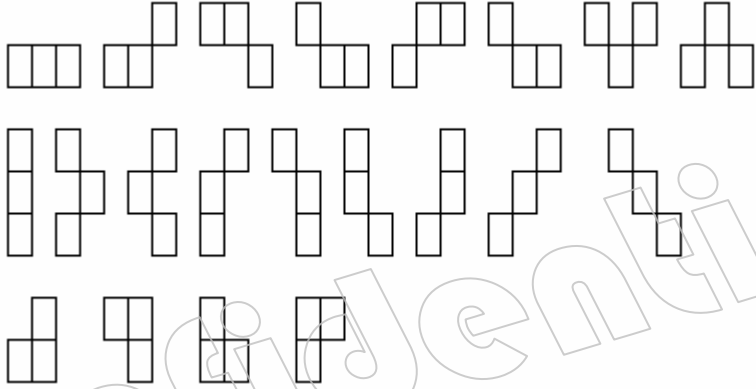
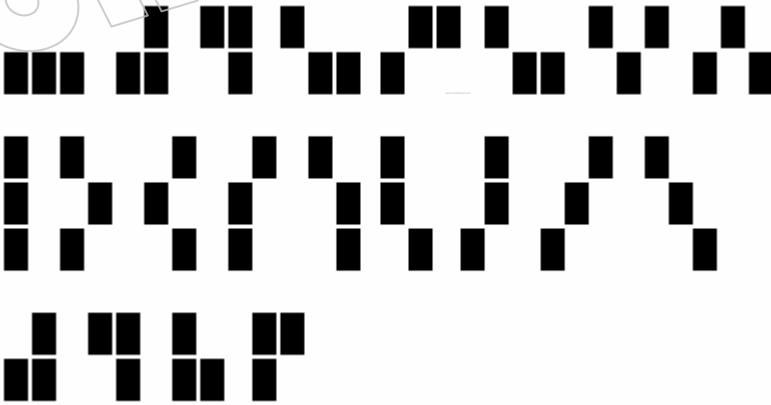
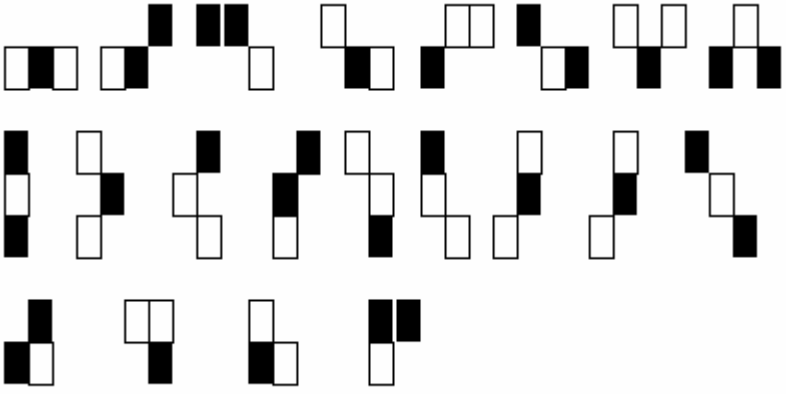
Defect pattern	 : Bright dot  : Dark dot	Criteria
3 defect dots	<p style="text-align: center;">Bright dot</p> 	0 set
	<p style="text-align: center;">Dark dot</p> 	
	<p style="text-align: center;">Combinations between bright dot and dark dot</p>  <p style="text-align: center;">Etc.</p>	Allowed

4.10.4 Appearance specifications

Defect pattern		Condition	Note 1	Criteria
Impure ingredient Stains Dust	Dot shape	$d < 0.2\text{mm}$		Allowed
		$0.2\text{mm} \leq d < 0.3\text{mm}$		≤ 10 points
		$0.3\text{mm} \leq d \leq 0.5\text{mm}$		≤ 3 points
		$d > 0.5\text{mm}$		0 point
		Adjacent other objects		
	Line shape	$W < 0.05\text{mm}$		Allowed
		$0.05\text{mm} \leq W \leq 0.1\text{mm}$	$L < 0.7\text{mm}$	
			$0.7\text{mm} \leq L \leq 1.0\text{mm}$	
			$L > 1.0\text{mm}$	0 point
	$W > 0.1\text{mm}$			
Bubbles, Wrinkles, Dent	$d \leq 0.2\text{mm}$		Allowed	
	$0.2\text{mm} < d \leq 0.5\text{mm}$		≤ 2 points	
	$d > 0.5\text{mm}$		0 point	
Polarizer scratch	$S \leq 0.2\text{mm}^2$		Allowed	
	$S > 0.2\text{mm}^2$		0 point	
Flick	Refer to limited samples			
Mura	Refer to limited samples			
Crosstalk	Refer to limited samples			

Note1: Definition of symbols is as follows.

d: Average diameter

(This diameter is the average length of a long axis and a short axis in each defect pattern.)

W: Width, L: Length, S: Area

Note2: Inspection conditions are as follows.

Temperature	$25 \pm 5^\circ\text{C}$
Inspection viewing distance	20cm (The distance between the inspector's eye and screen.)
Inspection direction	$0^\circ \leq \theta R \leq 45^\circ$, $0^\circ \leq \theta L \leq 45^\circ$
	$0^\circ \leq \theta U \leq 45^\circ$, $0^\circ \leq \theta D \leq 45^\circ$
Illumination	700lx (at an inspection desk surface)

Note3: If any problems arise with the LCMS suppliers by suppliers, the custom and supplier will cooperate and make efforts to solve it with mutual confidence and respect.

5. RELIABILITY TESTS

Test items	Condition	
High temperature and humidity(Operation)	① 50±3℃,RH=80%,240hours ② Display data is black Note1	
Low temperature (Operation)	① 0±3℃...240hours ② Display data is black	
ON & OFF cycle	① ON 1 minute/ OFF 1 minute ② 3000 times	
Thermal shock (Non operation)	① -20±3℃...30minutes 60±3℃...30minutes ② 100cycles,1hour/cycle ③ Temperature transition time is within 5 minutes.	
ESD (operation)	① 150Pf,150Ω,±8kV (contact) 150Pf,150Ω,±15kV(Air) ② 9 places on a panel surface(contact) 13places on a panel surface(Air) ③ 10 times each place at 1 sec interval Note2	
Vibration (Non operation)	① 10-200-10Hz , Sine wave , acceleration of 14.79m/s ² ② 30 minutes/cycle ③ X,Y,Z direction ④ 1 time each direction	
Mechanical shock (Non operation)	① 490 m/s ² , 11ms ② ±X, ±Y, ±Z direction ③ 2 times each direction	
Low pressure	operation	① 53.3kPa (Equivalent to altitude 4,850m) ② 0℃±3℃...24hours ③ 50℃±3℃...24hours
	non-operation	① 15kPa (Equivalent to altitude 13,600m) ② -20℃±3℃...24hours ③ 60℃±3℃... 24hours

Note1: Display and appearance are checked under environmental conditions equivalent to the inspection conditions of defect criteria.

Note2: See the following figure for discharge points.

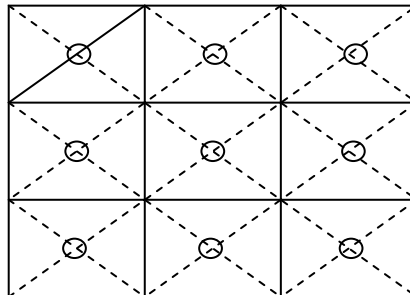

6. ESTIMATED LUMINANCE LIFETIME

The luminance lifetime is the time from initial luminance to half-luminance.

This lifetime is the estimated value, and is not guarantee value.

Condition	Luminance lifetime(MTTF) Note1	Unit
25°C(Ambient temperature of the product) Continuous operation and IBL=6.5mArms/lamp	50000	h

Note1: MTTF is mean time to half-luminance. In case the product works under low temperature environment, the lifetime becomes short.

Confidential

7. MARKINGS

The various markings are attached to this product. See “7.4 INDECATION LOCATIONS” for attachment positions.

7.1 PRODUCT LABEL



Note2

Note1: The meaning of lot number

•Example: 1111A104201001

<u>1111</u>	<u>A</u>	<u>1</u>	<u>04</u>	<u>9</u>	<u>01</u>	<u>001</u>
Internal use	Revision 1 letter (Alphabet)	Internal use	Manufacturing year 2 figures of the A.D. end numbers (e.g: A.D2004 is 04.)	Manufacturing month 1 letter	Manufacturing day	Production number Multi-letter (figure)

Jan. to Sep.: Number of month
 October: A
 November: B
 December: C

Note2: **Do not attach anything such as label and so on, on the product label!** In case repair the product, SVA-NEC needs the contents of Product label such as the lot number, inspection date and so on, to identify the warranty period with individual product. If SVA-NEC cannot decipher the contents of Product label, such repair shall be entitled to charge. Also SVA-NEC may give a new lot number to reconditioned products.

7.2 BARCODE LABEL



7.3 OTHER MARKINGS

High voltage caution marking



Disposal method marking for lamp



7.4 INDICATION LOCATIONS

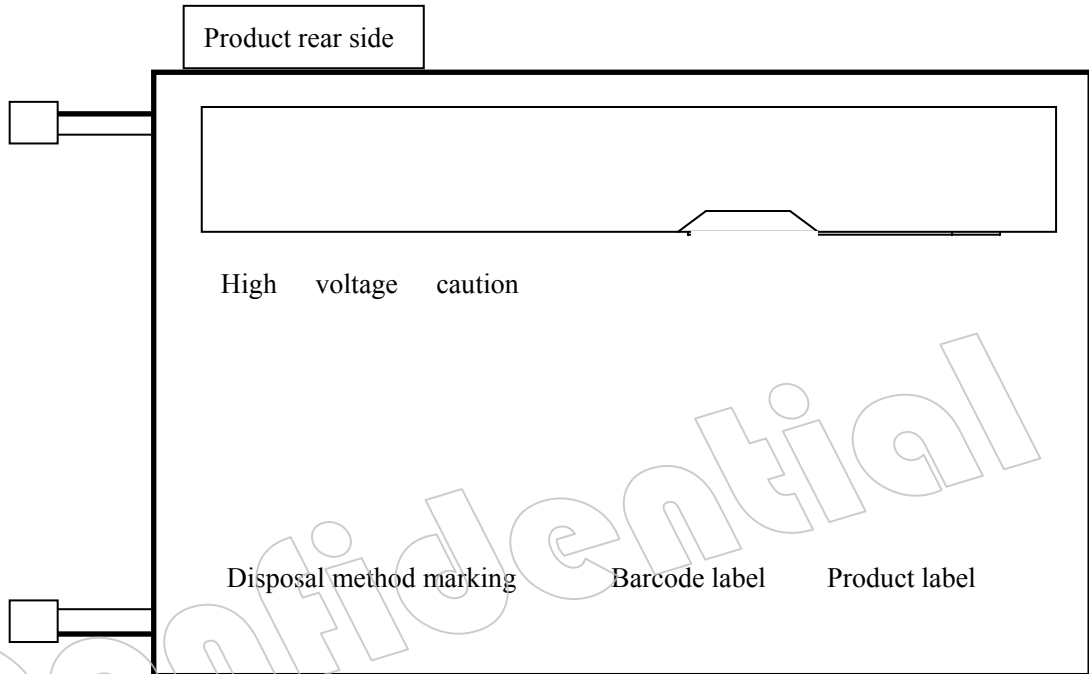

8. PACKING, TRANSPORTATION AND DELIVERY

SVA-NEC will pack products to deliver to customer in accordance with SVA-NEC packing specifications, and will deliver products to customer in such a state that products will not suffer from a damage during transportation .The delivery conditions are as follows.

8.1 PACKING

(1) Packing box

5 products are packed up with the maximum in a packing box(See “8.5 OUTLINE FIGURE FOR PACKING”).

Products are put into a plastic bag for prevention of moisture.

The type name and quality are shown on outside of the packing box, either labeling or printing.

(2)Pallet Packing (See”8.5 OUTLINE FIGURE FOR PACKING “)

- ① Packing boxes are tired on a cardboard pallet.(6 boxes×3 tiers maximum)
- ②Cardboard sleeve and top cap are attached to the packing boxes, then they are fixed by a band.

8.2 INSPECTION RECORD SHEET

Inspection record sheets are included in the packing box with delivery products to customer. It is summarized to a number of products for pass/fail assessment.

8.3 TRANSPORTATION

The product is transported by vehicle, aircraft or shipment in the state of pallet packing.

8.4 SIZE AND WEIGHT FOR PACKING BOX

Parameter	Packing box	Unit
Size	524 (L) x348 (W) x 423 (H) (typ.)	mm
Weight	1 (typ.)	kg
Total weight	13.5 (typ.) (with 5 products)	kg

8.5 OUTLINE FIGURE FOR PACKING

8.5.1 Packing box



LCD module



Packing box

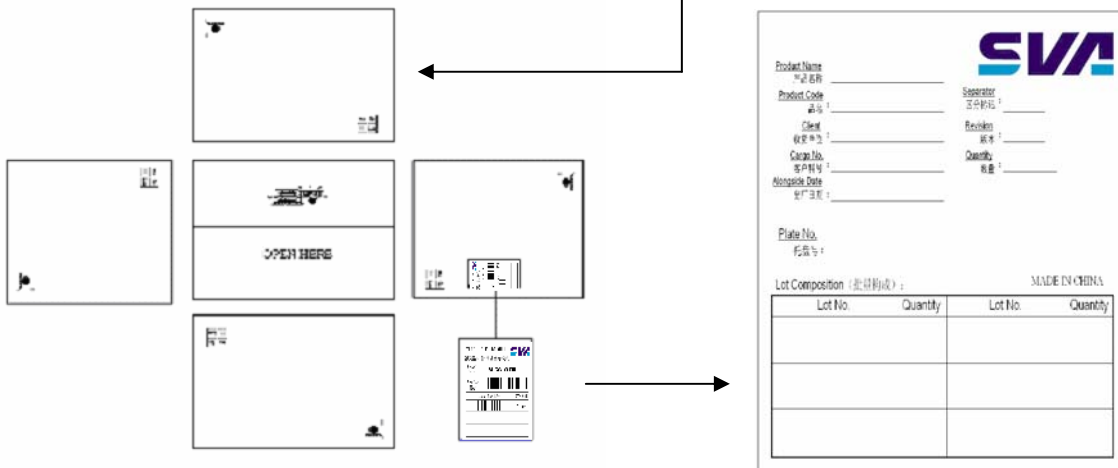

8.5.2 Pallet packing

Note: The ways for Packing and Shipping vary from different shipment volume, dependent on specific situations.

Packing boxes (6boxes×3 tiers maximum)

Cardboard pallet



Cardboard sleeve



Top cap

Band

9.PRECAUTIONS

9.1 MEANING OF CAUTION SIGNS

The following caution signs have very important meaning .**Be sure to read “9.2 CAUTIONS” and “9.3 ATTENTIONS”, after understanding these contents!**



This sign have the meaning that customer will be injured by himself or the product will sustain a damage, if customer has wrong operations.



This sign has the meaning that customer will get an electrical shock, if customer has wrong operations.



This sign has the meaning that customer will be injured by himself, if customer has wrong operations.

9.2 CAUTIONS



* touch lamp cables while turn on .Customers will be in danger of an electric shock



* **Do not touch the working backlight and IC. Customers will be in danger of burn injury.**
 * **Do not shock and press the LCD panel and the backlight! There is a danger of breaking, because they are made of glass.(shock :To be not greater 294m/s² and to be not greater 11ms, Pressure: To be not greater 19.6N)**

9.3 ATTENTIONS



9.3.1 Handling of the product

- ① Take hold of both ends without touch the circuit board when customer pulls out products (LCD modules) from inner packing box. If customer touches it, products may be broken down or out of adjustment, because of stress to mounting parts.
- ② Do not hook cables nor pull connection cables such as flexible cable and so on , for fear of damage.
- ③ If customer puts down the product temporarily, the product puts on flat subsoil as a display side turns down.
- ④ Take the measures of electrostatic discharge such as earth band, ionic shower and so on, when customer deal with the product, because products may be damaged by electrostatic.
- ⑤ The torque for mounting screws must never exceed 0.34N·m. Higher torque values might result in distortion of the bezel.
- ⑥ The product must be installed using mounting holes without undue stress such as bends or twist (See outline drawings).And do not add undue stress to any portion (such as bezel flat area) except mounting hole portion.

Bends or twist described above and undue stress to any portion except mounting hole portion may cause display un-uniformity.

- ⑦ Do not press or rub on the sensitive display surface .If customer clean on the panel surface, SVA-NEC recommends using the cloth with ethanolic liquid such as screen cleaner for LCD.
- ⑧ Do not push-pull the interface connectors while the product is working, because wrong power sequence may break down the product.
- ⑨ Do not bend or unbend the lamp cable at the near part of the lamp holding rubber, to avoid the damage for high voltage side of the lamp. This damage may cause a lamp breaking and abnormal operation of high voltage circuit.

9.3.2 Environment

- ① Do not operate or store in high temperature, high humidity, dewdrop atmosphere or corrosive gases. Keep the product in antistatic pouch in room temperature, because of avoidance for dusts and sunlight, if customer stores the product.
- ② In order to prevent dew condensation occurring by temperature difference, the product packing box must be opened after leave under the environment of an unpacking room temperature enough. Because a situation of dew condensation occurring is changed by the environment temperature and humidity, evaluate the leaving time sufficiently. (Recommendation leaving time: 6 hour or more with packing state)
- ③ Do not operate in a high magnetic field. Circuit boards may be broken down by it.
- ④ This product is not designed as radiation hardened.
- ⑤ Use an original protection sheet on the product surface (polarizer). Adhesive type protection sheet should be avoided, because it may change color or properties of the polarizer.

9.3.3 Characteristics

The following items are neither defects nor failures.

- ① Response time, luminance and color may be changed by ambient temperature.
- ② The LCD may be seemed luminance non-uniformity, flicker, vertical seam or small spot by display patterns.
- ③ Optical characteristics (e.g. luminance, display uniformity, etc.) gradually is going to change depending on operating time ,and especially low temperature, because the LCD has cold cathode fluorescent lamps.
- ④ Do not display the fixed pattern for a long time because it may cause image sticking .Use a screen saver, if the fixed pattern is displayed on the screen.
- ⑤ The display color may be changed by viewing angle because of the use of condenser sheet in the backlight.
- ⑥ Optical characteristics may be changed by input signal timings.
- ⑦ The interference noise of input signal frequency for this product and luminance control frequency of customer's backlight inverter may appear on a display. Set up luminance control frequency of backlight inverter so that the interference noise does not appear.

9.3.4 Other

- ① All GND and VCC terminals should be used without a non-connected line.
- ② Do not disassemble a product or adjust volume without permission of SVA-NEC.
- ③ Pay attention not to insert waste materials inside of products, if customer uses screw nails.
- ④ Pack the product with original shipping package, because of avoidance of some damages during transportation, when customer returns it to SVA-NEC for repair and so on .
- ⑤ Not only the module but also the equipment should be packed and transported as the module. becomes vertical .Otherwise, there is the fear that a display dignity decreases by an impact or vibrations.

10. OUTDRAWING

10.1 FRONT VIEW

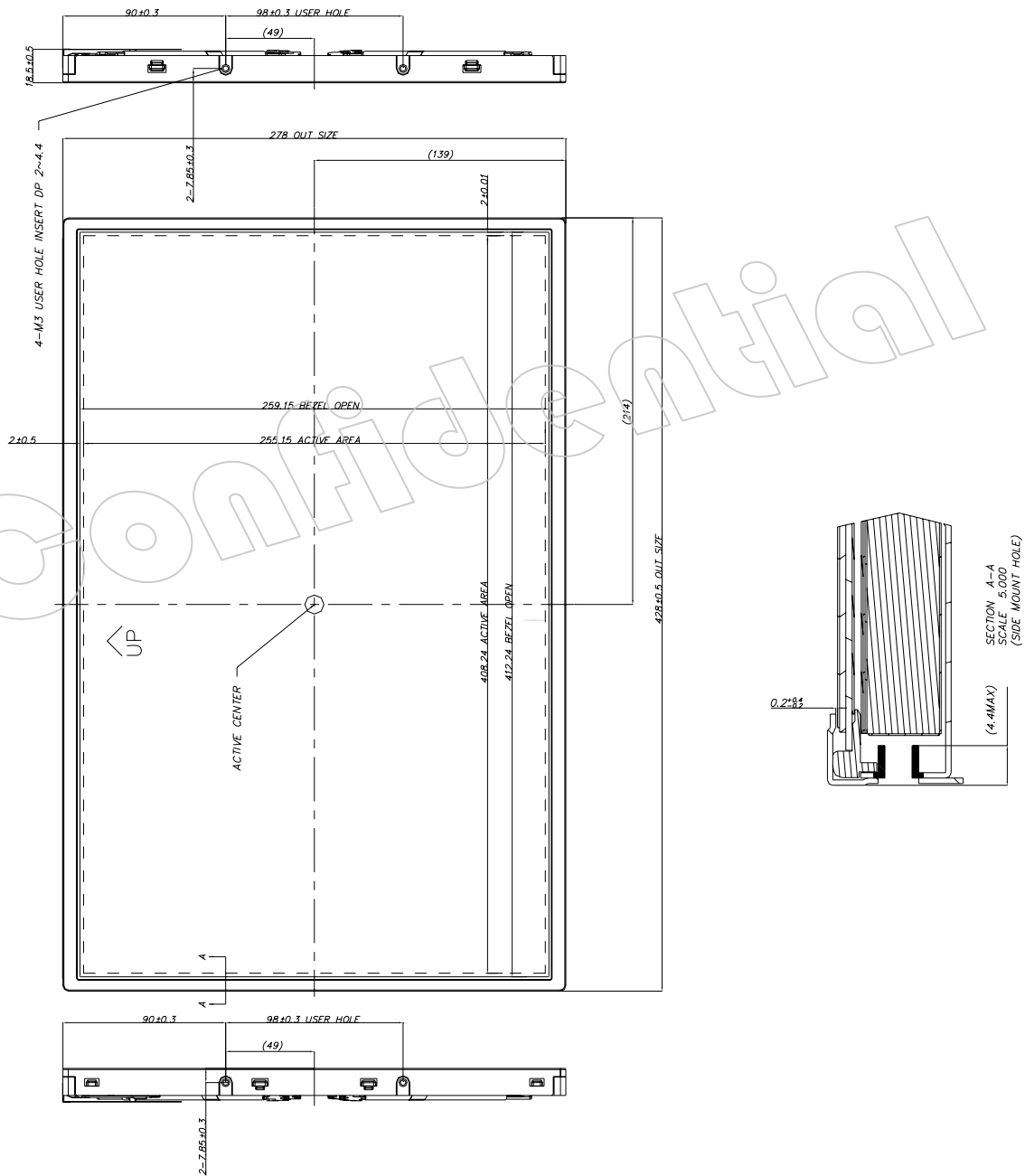

10.2 REAR VIEW

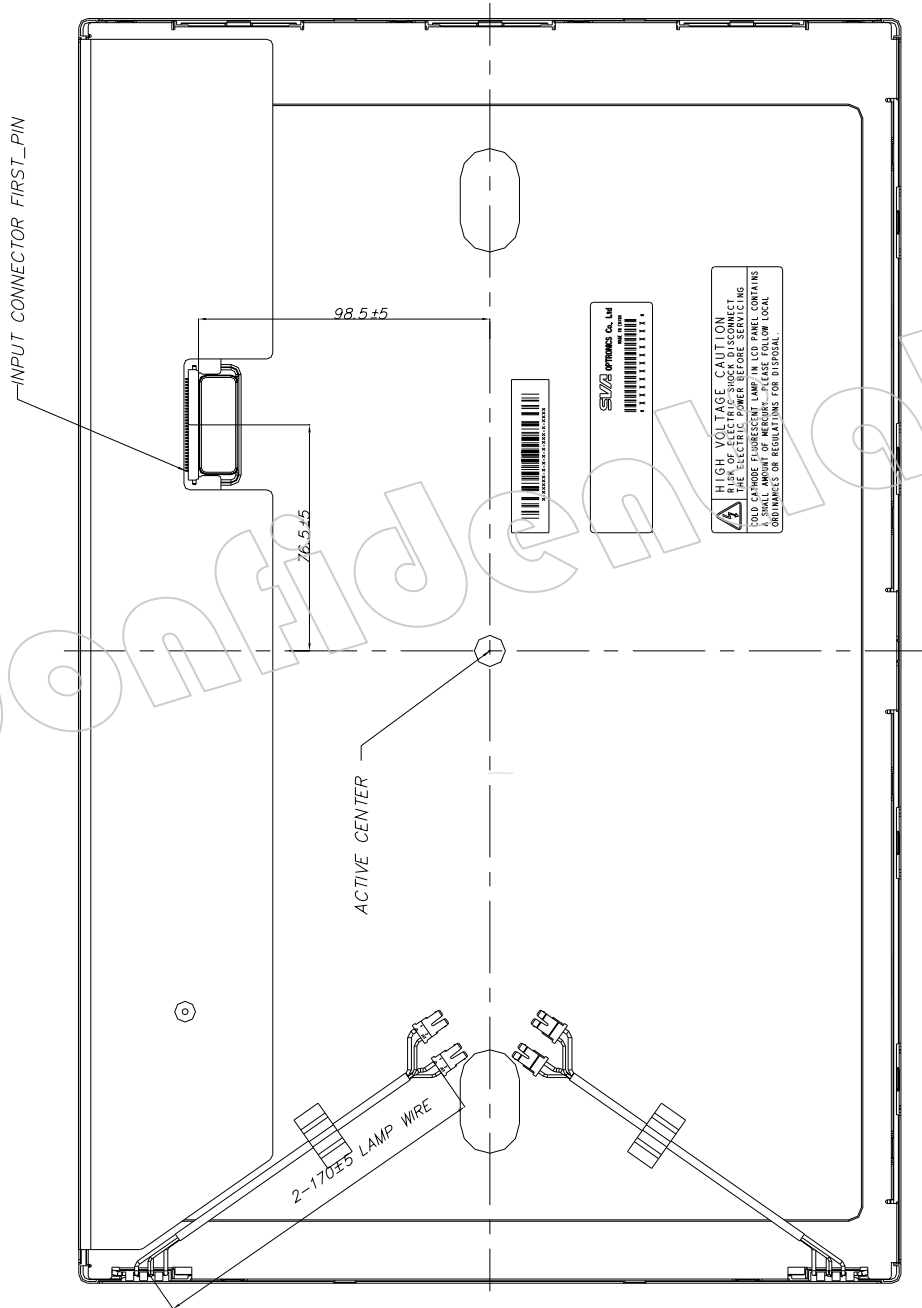

Rev	Revised date	Main Revision item and sign	Approved by	Checked by	Prepared by	Published date									
1.0	2007-1-24	<table border="1"> <tr> <td rowspan="2">s i g n</td> <td>品管</td> <td>营业</td> <td>产品技术</td> <td>产品验证</td> </tr> <tr> <td>一户</td> <td>许颐璐</td> <td>矢崎</td> <td>杜嘉祥</td> </tr> </table>	s i g n	品管	营业	产品技术	产品验证	一户	许颐璐	矢崎	杜嘉祥	Pei Ying Chen	T-kai	Shu Bingxian 2007-1-24	2007.1.12
s i g n	品管	营业		产品技术	产品验证										
	一户	许颐璐	矢崎	杜嘉祥											
2.0	2007-3-29	<table border="1"> <tr> <td rowspan="2">s i g n</td> <td>品管</td> <td>营业</td> <td>产品技术</td> <td>产品验证</td> </tr> <tr> <td><i>[Signature]</i></td> <td><i>[Signature]</i></td> <td><i>[Signature]</i></td> <td><i>[Signature]</i></td> </tr> </table> <p>Note: 1. The min. of CR was added to the spec.(p20) 2. The Ton and Toff of the response time was added to the spec.(p20)</p>	s i g n	品管	营业	产品技术	产品验证	<i>[Signature]</i>	<i>[Signature]</i>	<i>[Signature]</i>	<i>[Signature]</i>	<i>Pei Ying</i> <i>Chen</i> 2007. 3. 29	<i>J. Kai</i> 2007. 3. 29	Shu Bingxian 2007-3-29	2007.3.29
s i g n	品管	营业		产品技术	产品验证										
	<i>[Signature]</i>	<i>[Signature]</i>	<i>[Signature]</i>	<i>[Signature]</i>											