



4x6 RF Switch Matrix
800 - 900 MHz

Features

- High Isolation: 40 dB
- Low Current draw: < 2mA @ +5 V
< 10mA @ -5V
- 5V CMOS Logic
- 45mm PBGA Package
- JEDEC MO-151 Foot Print

PBGA Package Outline

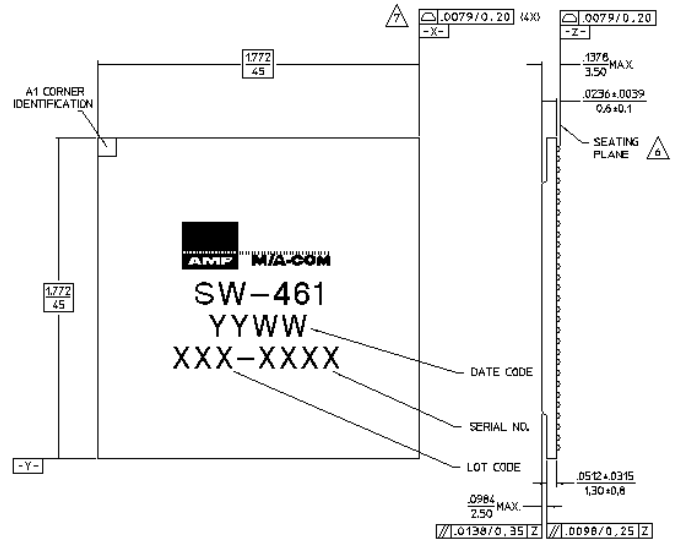

Description

M/A-COM's SW-461 is a multi-chip module containing six SP4T GaAs switches, each with a driver/decoder and four GaAs 6-way power dividers. The SW-461 utilizes Plastic Ball Grid Array (PBGA) interconnect technology to achieve high circuit density and superior high frequency performance. This device is ideal for telephony applications in the AMPS frequency bands.

The SW-461 is constructed with a multi layer PCB using a ball grid array for the I/O connects. The combination of several state-of-the-art technologies achieves high performance at a low cost.

Ordering Information

Part Number	Package
SW-461	45mm PBGA Package

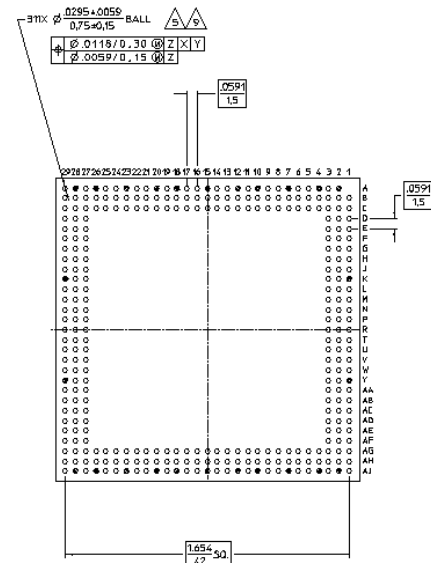

Electrical Specifications: T_A = +25°C¹, Control Voltage = +5.0V

Parameter	Test Conditions	Units	Min.	Typ.	Max.
Insertion Loss	800 - 900 MHz	dB		-11.5	-12
VSWR	800 - 900 MHz			1.5:1	1.9:1
Isolation	800 - 900 MHz	dB	42	57	
Balance	800 - 900 MHz	dB		0.7	1.2
P _{1dB}	800 - 900 MHz	dBm		33	

1. All measurements in a 50Ω system.

Specifications subject to change without notice.

- North America: Tel. (800) 366-2266, Fax (800) 618-8883
- Asia/Pacific: Tel.+81-44-844-8296, Fax +81-44-844-8298
- Europe: Tel. +44 (1344) 869 595, Fax+44 (1344) 300 020

Visit www.macom.com for additional data sheets and product information.



Absolute Maximum Ratings¹

Parameter	Absolute Maximum
Maximum Voltage	-5V, 5V
Maximum Current	-10 mA, 20 mA
Maximum Dissipated Power	150 mW
Total Maximum Input Power	36 dBm
Storage Temperature	-65°C to +150°C
Operating Temperature	0° to 65°C

- Exceeding any one or a combination of these limits may cause permanent damage.

Truth Table^{1,2}

Output _n Control Pair ³		Selected Input
A	B	
0	0	1
1	0	2
0	1	3
1	1	4

- "0" = 0±0.2V
- "1" = 5±0.2V
- n = SP4T 1 through 6

Functional Schematic

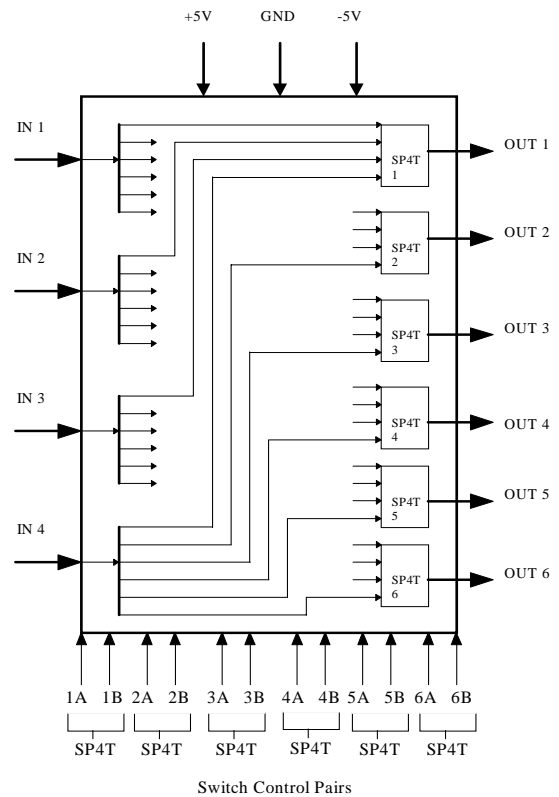

Typical Performance Curves

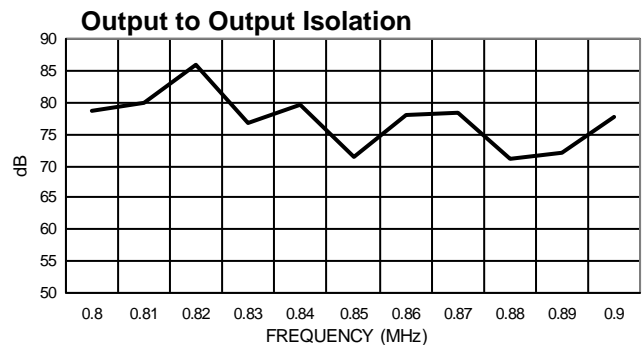
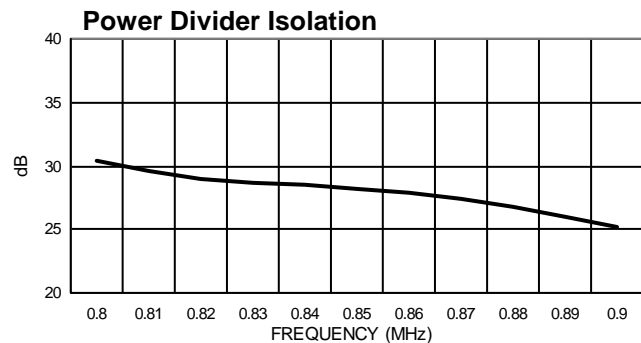

Specifications subject to change without notice.

V 2.0

- North America: Tel. (800) 366-2266, Fax (800) 618-8883
- Asia/Pacific: Tel. +81-44-844-8296, Fax +81-44-844-8298
- Europe: Tel. +44 (1344) 869 595, Fax +44 (1344) 300 020

Visit www.macom.com for additional data sheets and product information.

Typical Performance Curves (Cont'd)

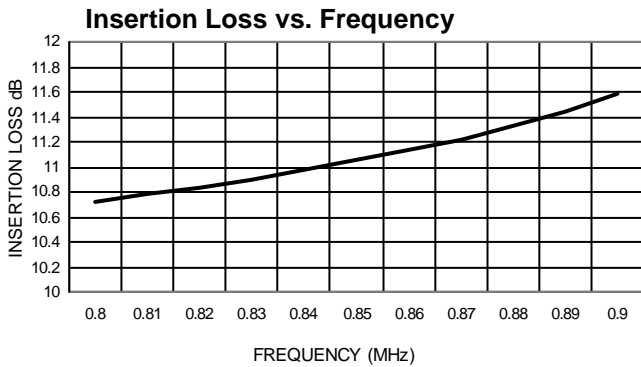
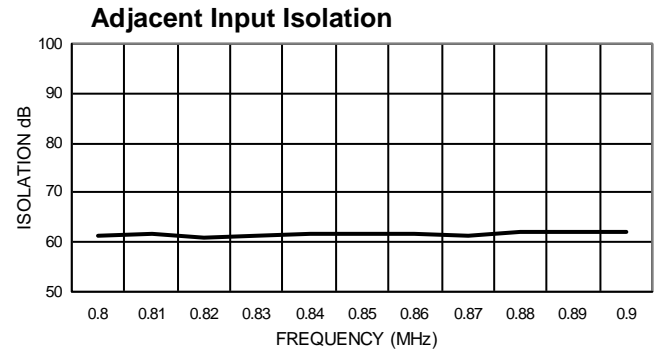
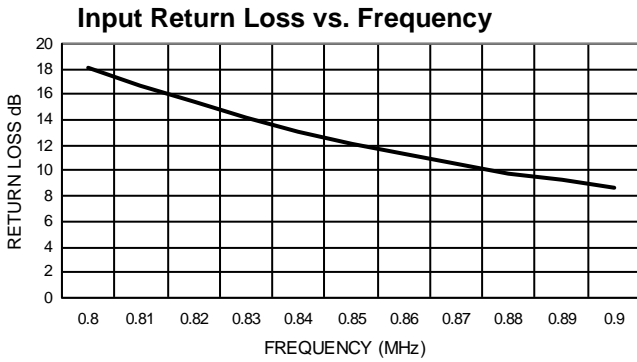
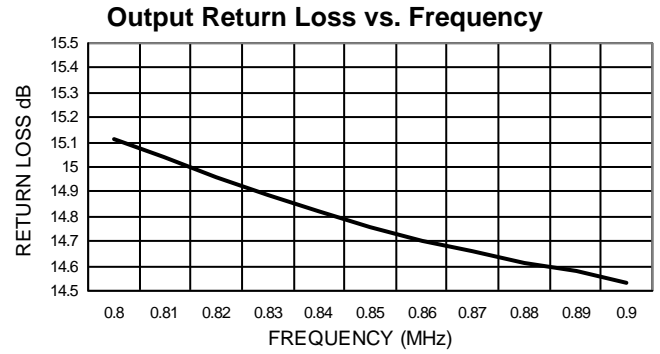
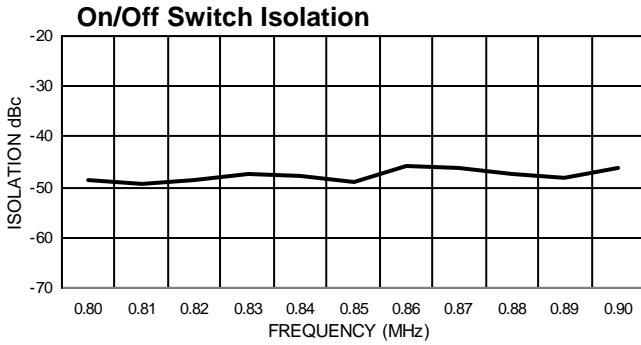

Specifications subject to change without notice.

V.2.0

- North America: Tel. (800) 366-2266, Fax (800) 618-8883
- Asia/Pacific: Tel.+81-44-844-8296, Fax +81-44-844-8298
- Europe: Tel. +44 (1344) 869 595, Fax+44 (1344) 300 020

Visit www.macom.com for additional data sheets and product information.

tyco / Electronics

MACOM