

## N-channel SOT-23 MOSFET

### Features

- High ruggedness
- $R_{DS(ON)}$  (Max0.24 $\Omega$ )@ $V_{GS}=10V$
- Gate Charge (Typical 13nC)
- Improved dv/dt Capability
- 100% Avalanche Tested

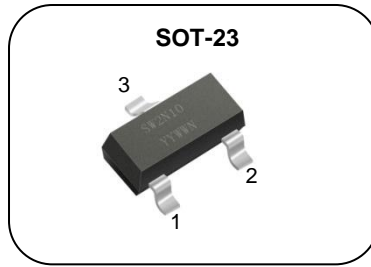

1. Gate 2. Source 3. Drain

$BV_{DSS} : 100V$

$I_D : 2A$

$R_{DS(ON)} : 0.24\Omega$

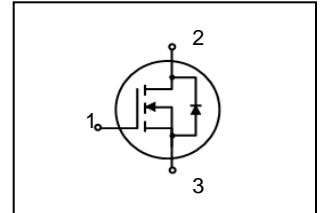

### General Description

This power MOSFET is produced with advanced VDMOS technology of SAMWIN. This technology enable power MOSFET to have better characteristics, such as fast switching time, low on resistance, low gate charge and especially excellent avalanche characteristics. This power MOSFET is usually used at high efficient DC to DC converter block and switch mode power supply.

### Order Codes

Item	Sales Type	Marking	Package	Packaging
1	SW E 2N10	SW2N10	SOT-23	RELL

### Absolute maximum ratings

Symbol	Parameter	Value	Unit
$V_{DSS}$	Drain to Source Voltage	100	V
$I_D$	Continuous Drain Current (@ $T_C=25^\circ C$ )	2*	A
	Continuous Drain Current (@ $T_C=100^\circ C$ )	1.26*	A
$I_{DM}$	Drain current pulsed (note 1)	8	A
$V_{GS}$	Gate to Source Voltage	$\pm 15$	V
$E_{AS}$	Single pulsed Avalanche Energy (note 2)	64	mJ
$E_{AR}$	Repetitive Avalanche Energy (note 1)	5	mJ
dv/dt	Peak diode Recovery dv/dt (note 3)	5	V/ns
$T_{STG}, T_J$	Operating Junction Temperature & Storage Temperature	-55 ~ + 150	$^\circ C$
$T_L$	Maximum Lead Temperature for soldering purpose, 1/8 from Case for 5 seconds.	300	$^\circ C$

\*. Drain current is limited by junction temperature.

Electrical characteristic (  $T_C = 25^\circ\text{C}$  unless otherwise specified )

Symbol	Parameter	Test conditions	Min.	Typ.	Max.	Unit
<b>Off characteristics</b>						
$BV_{DSS}$	Drain to source breakdown voltage	$V_{GS}=0V, I_D=250\mu A$	100			V
$\Delta BV_{DSS} / \Delta T_J$	Breakdown voltage temperature coefficient	$I_D=250\mu A$ , referenced to $25^\circ\text{C}$		0.1		$V/^\circ\text{C}$
$I_{DSS}$	Drain to source leakage current	$V_{DS}=100V, V_{GS}=0V$			1	$\mu A$
		$V_{DS}=80V, T_C=125^\circ\text{C}$			50	$\mu A$
$I_{GSS}$	Gate to source leakage current, forward	$V_{GS}=15V, V_{DS}=0V$			100	nA
	Gate to source leakage current, reverse	$V_{GS}=-15V, V_{DS}=0V$			100	nA
<b>On characteristics</b>						
$V_{GS(TH)}$	Gate threshold voltage	$V_{DS}=V_{GS}, I_D=250\mu A$	1		3	V
$R_{DS(ON)}$	Drain to source on state resistance	$V_{GS}=10V, I_D=3.5A$		0.20	0.24	$\Omega$
		$V_{GS}=4.5V, I_D=2A$		0.22	0.24	$\Omega$
<b>Dynamic characteristics</b>						
$C_{iss}$	Input capacitance	$V_{GS}=0V, V_{DS}=25V, f=1\text{MHz}$		550		pF
$C_{oss}$	Output capacitance			50		
$C_{rss}$	Reverse transfer capacitance			33		
$t_{d(on)}$	Turn on delay time	$V_{DS}=50V, I_D=2A, R_G=25\Omega$ (note 4, 5)		3.5		ns
$t_r$	Rising time			22		
$t_{d(off)}$	Turn off delay time			40		
$t_f$	Fall time			25		
$Q_g$	Total gate charge	$V_{DS}=80V, V_{GS}=10V, I_D=2A$ (note 4, 5)		13		nC
$Q_{gs}$	Gate-source charge			1.7		
$Q_{gd}$	Gate-drain charge			3.2		

### Source to drain diode ratings characteristics

Symbol	Parameter	Test conditions	Min.	Typ.	Max.	Unit
$I_S$	Continuous source current	Integral reverse p-n Junction diode in the MOSFET			2	A
$I_{SM}$	Pulsed source current				8	A
$V_{SD}$	Diode forward voltage drop.	$I_S=2A, V_{GS}=0V$			1.1	V
$T_{rr}$	Reverse recovery time	$I_S=2A, V_{GS}=0V,$ $di_f/dt=100A/\mu s$		28		ns
$Q_{rr}$	Reverse recovery Charge				33	nC

#### ※. Notes

1. Repeative rating : pulse width limited by junction temperature.
2.  $L = 32.1\text{mH}, I_{AS} = 2A, V_{DD} = 50V, R_G=25\Omega$ , Starting  $T_J = 25^\circ\text{C}$
3.  $I_{SD} \leq 2A, di/dt = 100A/\mu s, V_{DD} \leq BV_{DSS}$ , Starting  $T_J = 25^\circ\text{C}$
4. Pulse Test : Pulse Width  $\leq 300\mu s$ , duty cycle  $\leq 2\%$
5. Essentially independent of operating temperature.

**Fig. 1. On-state characteristics**

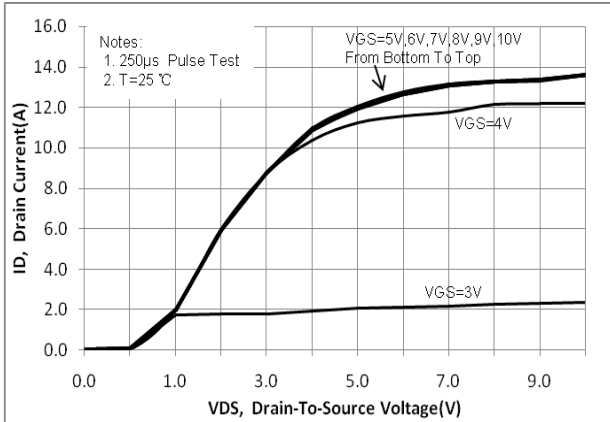

**Fig. 2. On-resistance variation vs. drain current and gate voltage**

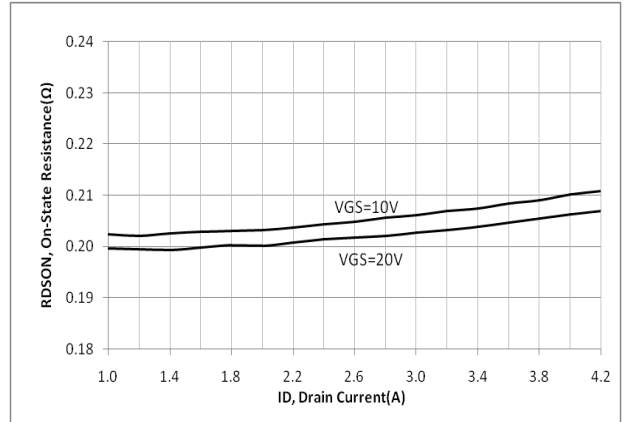

**Fig. 3. Gate charge characteristics**

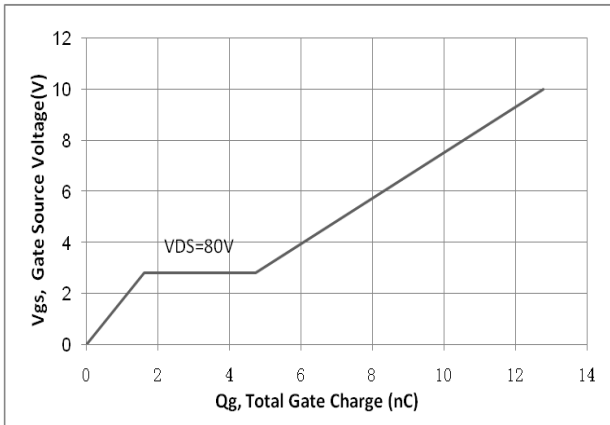

**Fig. 4. On state current vs. diode forward voltage**

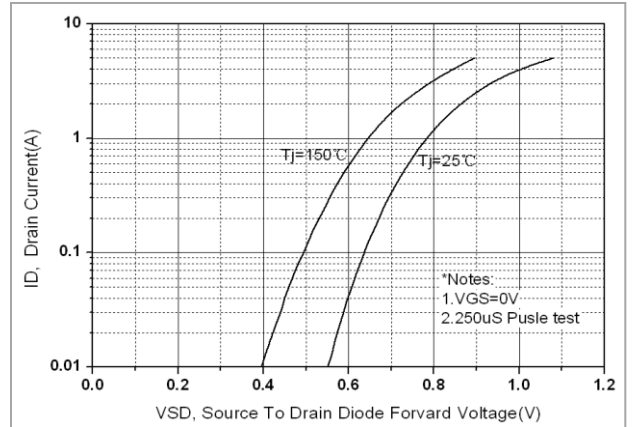

**Fig 5. Breakdown Voltage Variation vs. Junction Temperature**

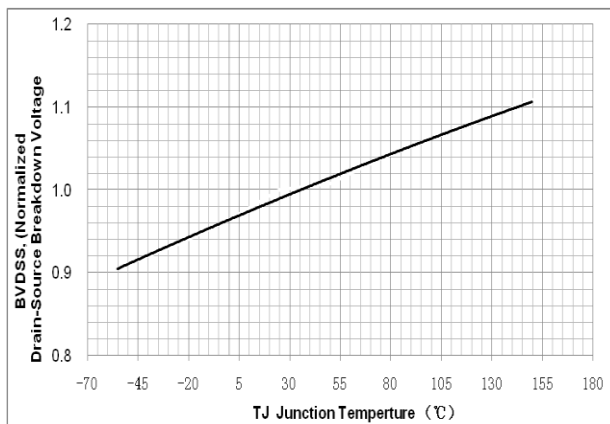

**Fig. 6. On resistance variation vs. junction temperature**

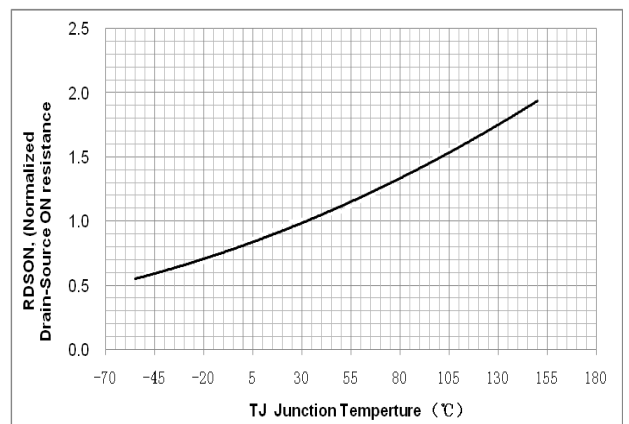

**Fig. 7. Capacitance Characteristics**

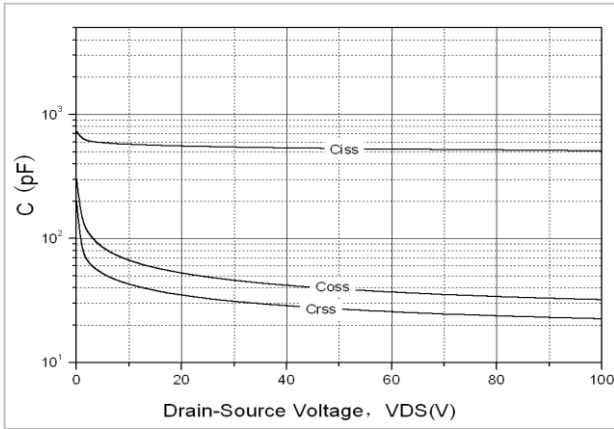

**Fig. 8. Gate charge test circuit & waveform**

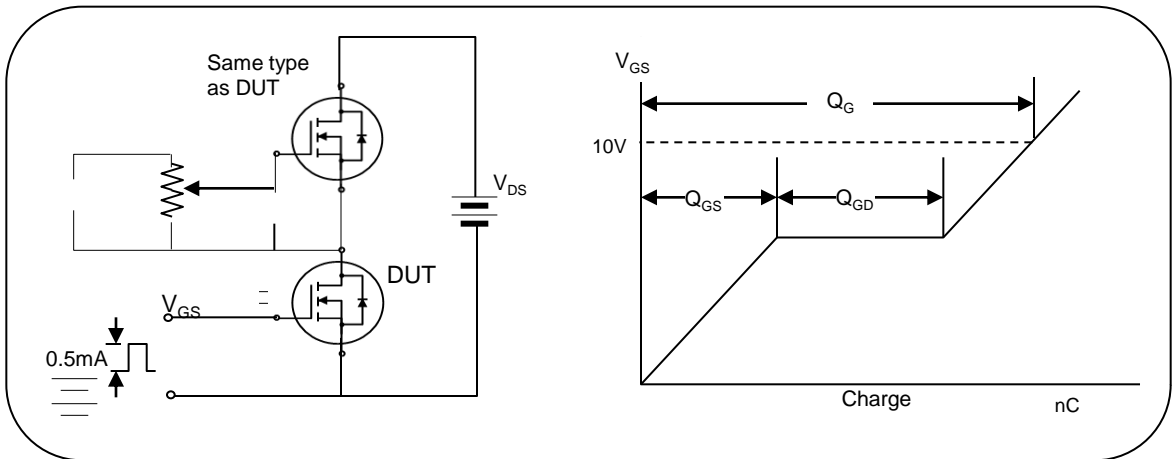

**Fig. 9. Switching time test circuit & waveform**

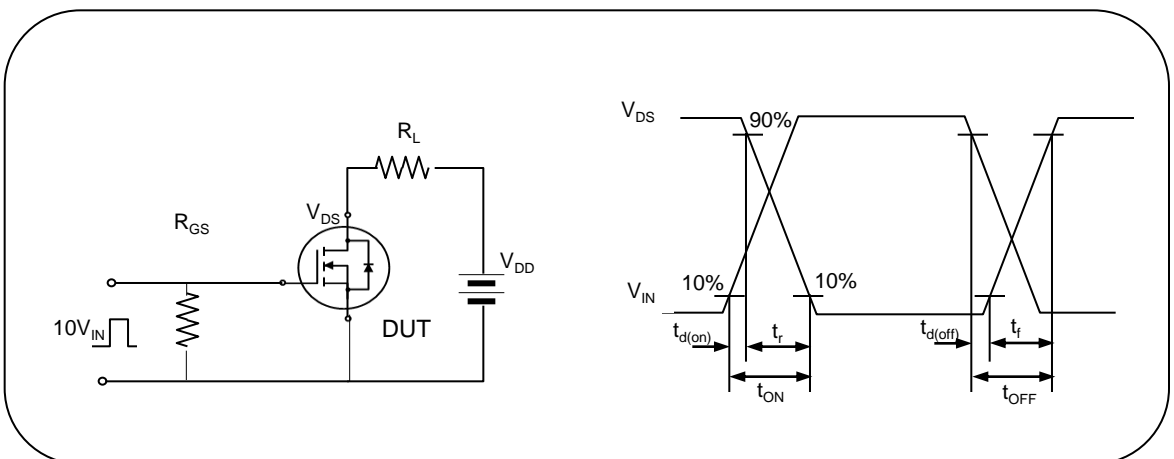

**Fig. 10. Unclamped Inductive switching test circuit & waveform**

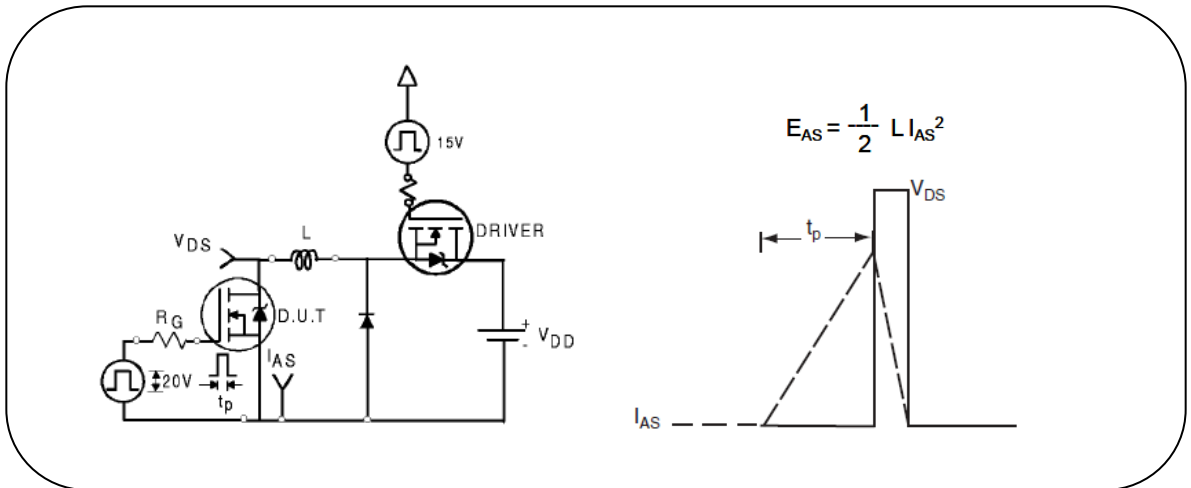

**Fig. 11. Peak diode recovery dv/dt test circuit & waveform**

