

HIGH CURRENT POWER INDUCTORS

SWDY0806-NC SERIES

1. PART NO. EXPRESSION :

SWDY0806-R56MF-NC

(a) (b) (c) (d)(e) (f)

(a) Series code

(b) Dimension code

(c) Inductance code : R56 = 0.56uH

(d) Tolerance code : M = ±20%

(e) F : Lead Free

(f) NC : No Cover

2. CONFIGURATION & DIMENSIONS :

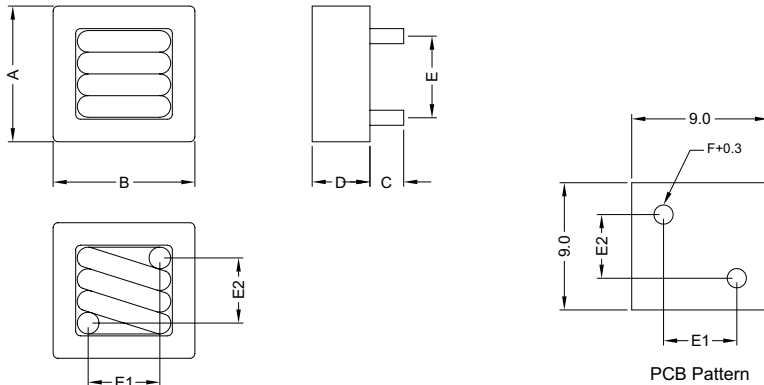

Part No.	A mm	B mm	C mm	D mm	E mm	E1 mm	E2 mm	F mm
SWDY0806-R47MF-NC	8.2 MAX.	8.2 MAX.	3.5±0.5	6.0 MAX.	6.3±0.5	4.5±0.5	4.4±0.5	0.9±0.1
SWDY0806-R60MF-NC	8.2 MAX.	8.2 MAX.	3.5±0.5	6.0 MAX.	6.3±0.5	4.5±0.5	4.4±0.5	0.9±0.1
SWDY0806-R80MF-NC	8.2 MAX.	8.2 MAX.	3.5±0.5	6.0 MAX.	6.2±0.5	4.5±0.5	4.3±0.5	0.8±0.1
SWDY0806-1R0MF-NC	8.2 MAX.	8.2 MAX.	3.5±0.5	6.0 MAX.	6.3±0.5	4.4±0.5	4.5±0.5	0.7±0.1

3. SCHEMATIC :

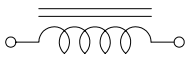

4. MATERIALS :

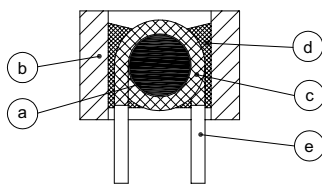

(a) Core : Iron Powder R Core

(b) Core : Iron Powder RI Core

(c) Wire : Enamelled Copper Wire

(d) Adhesive : Epoxy

(e) Terminal : Tinned Copper Plate

5. GENERAL SPECIFICATION :

a) Ambient temp. : 25°C

b) Irms(A) : Will cause temperature rise approximately 40°C without core loss

c) Isat(A) : Will cause L_o to drop approximately 20%



RoHS Compliant

NOTE : Specifications subject to change without notice. Please check our website for latest information.



SUPERWORLD ELECTRONICS (S) PTE LTD

07.04.2008

PG. 1

6. ELECTRICAL CHARACTERISTICS :

Part No.	Inductance L ₀ (μ H)	Test Frequency (Hz)	DCR (m Ω) \pm 8%	I _{rms} (A) Max.	I _{sat} (A) Max.
SWDY0806-R47MF-NC	0.47 \pm 20%	1.0V / 100K	1.90	22	38
SWDY0806-R60MF-NC	0.60 \pm 20%	1.0V / 100K	1.90	21	34
SWDY0806-R80MF-NC	0.80 \pm 20%	1.0V / 100K	2.90	17	27
SWDY0806-1R0MF-NC	1.00 \pm 20%	1.0V / 100K	4.30	14	22

7. INDUCTANCE VS. DC BIAS CURVES :

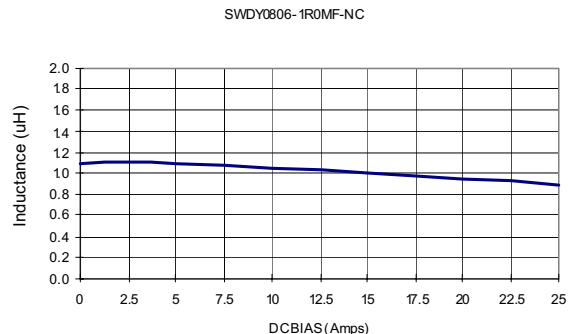
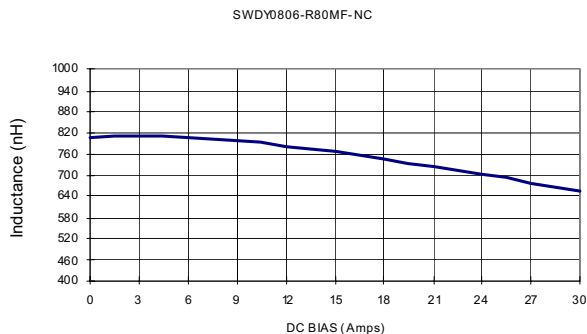
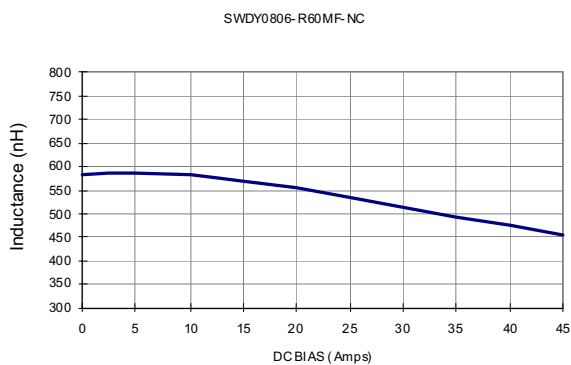
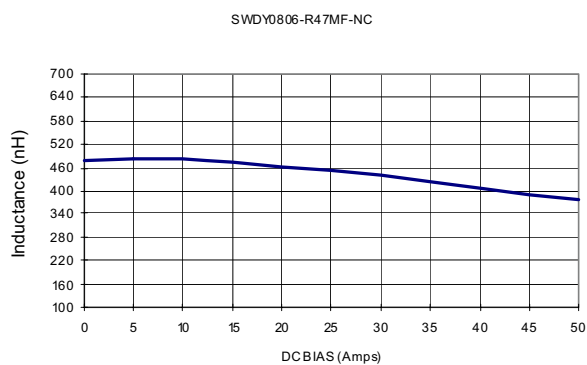

RoHS Compliant

NOTE : Specifications subject to change without notice. Please check our website for latest information.

07.04.2008



SUPERWORLD ELECTRONICS (S) PTE LTD

8. TEMPERATURE RISE VS DC BIAS CURVES : :

SWDY0806-R47MF-NC

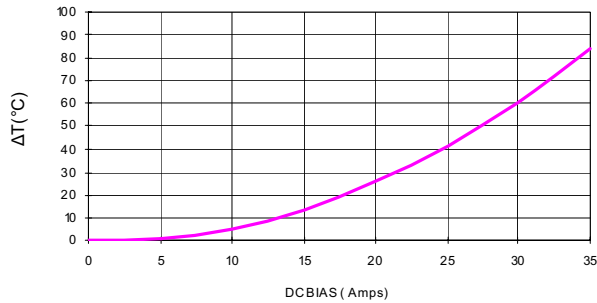

SWDY0806-R60MF-NC

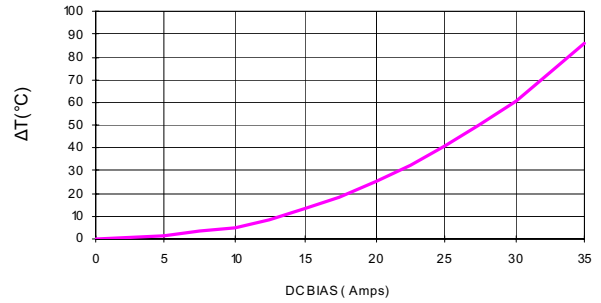

SWDY0806-R80MF-NC

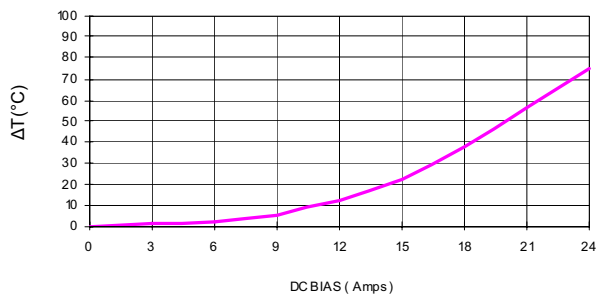

SWDY0806-R10MF-NC

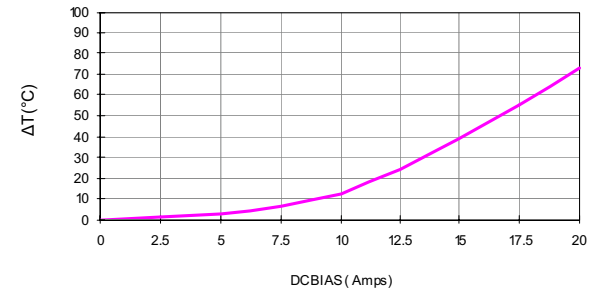

RoHS Compliant

NOTE : Specifications subject to change without notice. Please check our website for latest information.

07.04.2008



SUPERWORLD ELECTRONICS (S) PTE LTD