

### General Description

The SX1301 digital baseband chip is a massive digital signal processing engine specifically designed to offer breakthrough gateway capabilities in the ISM bands worldwide. It integrates the LoRa concentrator IP.

The LoRa concentrator is a multi-channel high performance transmitter/receiver designed to simultaneously receive several LoRa packets using random spreading factors on random channels. Its goal is to enable robust connection between a central wireless data concentrator and a massive amount of wireless end-points spread over a very wide range of distances.

The SX1301 is targeted at smart metering fixed networks and Internet of Things applications.

### Key Product Features

- Up to -142 dBm sensitivity with SX1257 or SX1255 Tx/Rx front-end
  - -139.5 dBm with included ref design
- 70 dB CW interferer rejection at 1 MHz offset
- Able to operate with negative SNR
  - CCR up to 9 dB
- Emulates 49x LoRa demodulators and 1x (G)FSK demodulator
- Dual digital Tx & Rx radio front-end interfaces
- 10 programmable parallel demodulation paths
- Dynamic data-rate adaptation (ADR)
- True antenna diversity or simultaneous dual-band operation

### Ordering Information

Part Number	Conditioning
SX1301IMLTRC	Tape & Reel 3,000 parts per reel
SX1301IMLTRT	Tape & Reel 500 parts per reel

### Applications

- Smart Metering
- Security Sensors Network
- Agricultural Monitoring
- Internet of Things (IoT)

Pb-free, Halogen free, RoHS/WEEE compliant product

**Contents**

1	PIN CONFIGURATION .....	4
1.1	Pins Placement and Circuit Marking .....	4
1.2	Pins Description .....	5
2	ELECTRICAL CHARACTERISTICS .....	7
2.1	Absolute Maximum Ratings .....	7
2.2	Constraints on External .....	7
2.3	Operating Conditions .....	7
2.4	Electrical Specifications .....	8
2.5	Timing Specifications .....	8
3	CIRCUIT OPERATION .....	9
3.1	General Presentation .....	9
3.2	Power-on .....	9
3.2.1	Power-up Sequence .....	9
3.2.2	Setting the Circuit is Low-power Mode .....	9
3.3	Clocking .....	10
3.4	SPI Interface .....	11
3.5	Rx I/Q Interface .....	12
3.5.1	I/Q Generated on Clock Rising Edge .....	12
3.5.2	I/Q Generated on Clock Falling Edge .....	12
3.6	RX Mode Block Diagram, Reception Paths Characteristics .....	13
3.6.1	Block Diagram .....	13
3.6.2	Reception Paths Characteristics .....	14
3.7	Packet Engine and Data Buffers .....	15
3.7.1	Receiver Packet Engine .....	15
3.7.2	Transmitter Packet Engine .....	17
3.8	Receiver IF Frequencies Configuration .....	19
3.8.1	Configuration Using 2 x SX1257 Radios .....	19
3.8.2	Two SX1255: 433 MHz Band .....	21
3.8.3	One SX1257 and one SX1255 .....	21
3.9	Connection to RF Front-end .....	22
3.9.1	Connection to Semtech SX1255 or SX1257 Components .....	22
3.9.2	SX1301 RX Operation using a Third Party RF Front-end .....	22
3.9.3	Radio Calibration .....	24
3.9.4	SX1301 Connection to RF front-end for TX Operation .....	24
3.10	Reference Application .....	26
3.11	SX1301 Sensitivity Performance in Reference Application .....	27
3.12	SX1301 Sensitivity vs Data Rate in LoRa Mode .....	28
3.12.1	125kHz Mode: IF8, IF[0 to 7] Paths .....	28
3.12.2	250 & 500 kHz Mode: IF8 only .....	29
3.13	SX1301 Interference Rejection .....	29
3.14	Hardware Abstraction Layer (HAL) .....	31
3.14.1	Introduction .....	31
3.14.2	Abstraction Presented to the Gateway Host .....	32
4	EXTERNAL COMPONENTS .....	33
5	PCB LAYOUT CONSIDERATIONS .....	34

6	PACKAGING INFORMATION .....	37
6.1	Package Outline Drawing .....	37
6.2	Thermal Impedance of Package .....	37
6.3	Land Pattern Drawing .....	38
7	REVISION INFORMATION .....	39

**Figures**

Figure 1: Top View of SX1301 Package with 64 Pins and Exposed Ground Paddle (Package Bottom) ..	4
Figure 2: Power-up Sequence .....	9
Figure 3: SPI Timing Diagram (Single Access).....	11
Figure 4: I/Q on Clock Rising Edge .....	12
Figure 5: I/Q on Clock Falling Edge .....	12
Figure 6 SX1301 Digital Baseband Chip Block Diagram .....	13
Figure 7: Access FIFO and Data Buffer .....	16
Figure 8: SX1255/57 Digital I/Q Power Spectral Density .....	19
Figure 9: Radio Spectrum.....	20
Figure 10 Radio Spectrum.....	20
Figure 11: Radio Spectrum.....	21
Figure 12: Dual Band Operation.....	22
Figure 13: SX1301 with Third Party Frontend.....	23
Figure 14: Digital Interface for Third Party Radio .....	23
Figure 15: Transmission Schematics .....	25
Figure 16: Reference Application.....	26
Figure 17: CW Interferer Rejection at SF7 for 50% PER at Sensitivity + 3dB .....	30
Figure 18: CW Interferer Rejection at SF12 for 50% PER at Sensitivity + 3dB .....	30
Figure 19: EPCOS B3117 SAW Filter Transfer Function .....	31
Figure 20: PCB Layout Example.....	36
Figure 21: Package Dimensions .....	37
Figure 22: Land Pattern Drawing .....	38

**Tables**

Table 1: Pins Name and Description .....	6
Table 2: Absolute Maximum Ratings .....	7
Table 3: Externals.....	7
Table 4: Operating Conditions for Electrical Specifications .....	7
Table 5: Electrical Specifications.....	8
Table 6: Timing Specifications.....	8
Table 7: Packet Data Fields .....	17
Table 8: Packet Structure for Transmission .....	18
Table 9: IF Frequencies Set .....	20
Table 10: IF Frequency Used .....	21
Table 11: SX1301 Performance in Reference Application .....	27
Table 12: Sensitivity with 125 kHz Mode .....	28
Table 13: Sensitivity with 250 kHz Mode .....	29
Table 14: Sensitivity with 500 kHz Mode .....	29
Table 15: Recommended External Components .....	33

**1 Pin Configuration**

**1.1 Pins Placement and Circuit Marking**

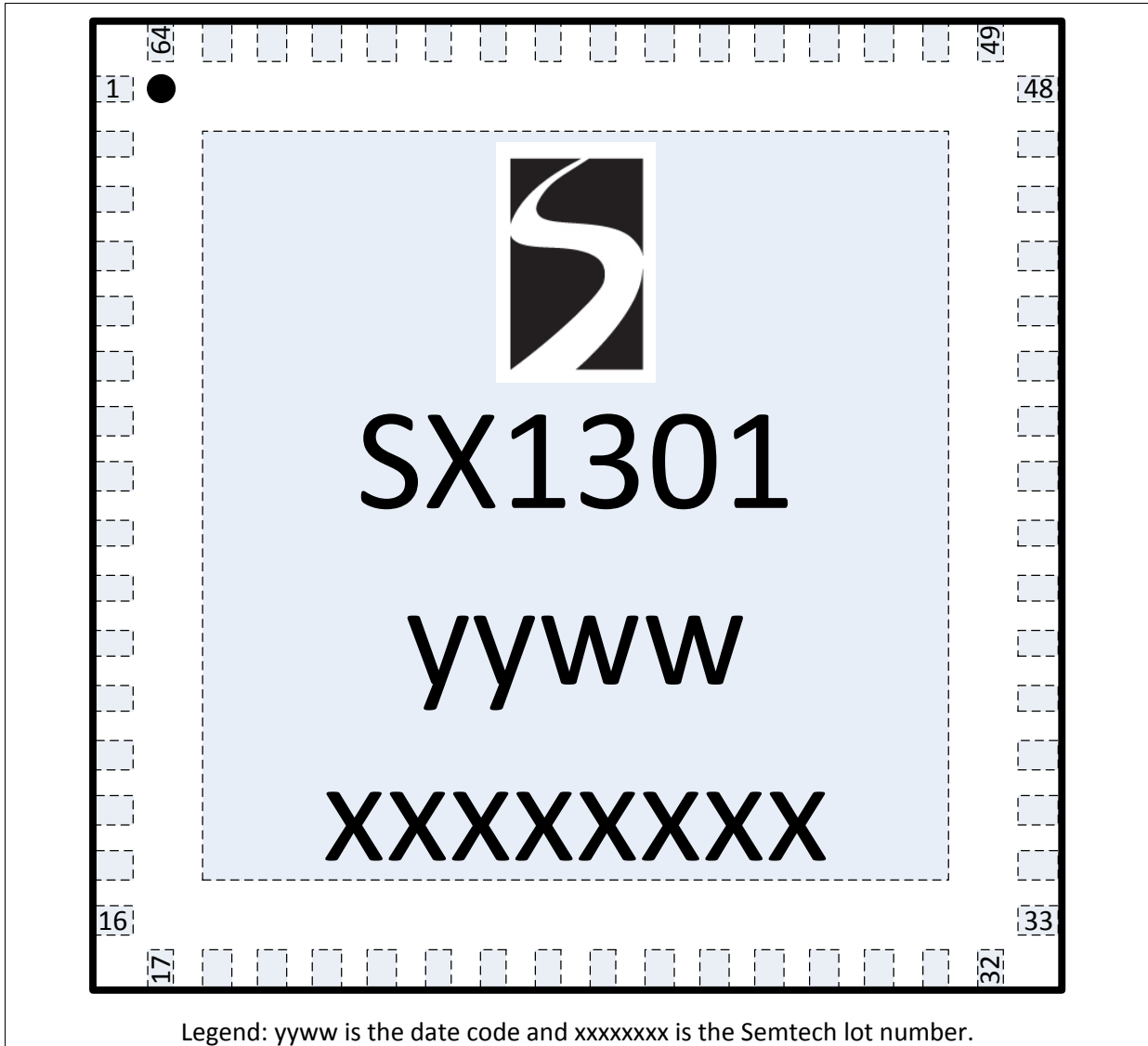

**Figure 1: Top View of SX1301 Package with 64 Pins and Exposed Ground Paddle (Package Bottom)**

The ground paddle must be connected to ground potential through a large conductive plane that also serves for temperature dissipation.

**1.2 Pins Description**

The table below gives the description of the pins of the circuit.

Pin	Pin Name	Type	Description
0	VSS	Power (GND)	Ground paddle – <b>must be connected to ground for thermal dissipation</b>
1	RESET	Input	Global asynchronous reset
2	HOST_SCK	Input	HOST SPI clock (max 10 MHz clock)
3	HOST_MISO	Output	HOST SPI Interface
4	HOST_MOSI	Input	HOST SPI Interface
5	HOST_CSN	Input	HOST SPI Interface
6	SCANMODE	Input	Scanmode signal (tied to 0 in normal mode)
7	VSS	Power (GND)	Ground
8	VCC18	Power (VDD)	Logic core supply
9	GPS_IN	Input	GPS 1 pps input
10	VSS	Power (GND)	Ground
11	VSS	Power (GND)	Ground
12	VCC18	Power (VDD)	Logic core supply
13	RADIO_A_EN	Output	Radio A global enable
14	LNA_A_CTRL	Output	LNA A enable
15	PA_A_CTRL	Output	PA A enable
16	NC		Not connected – tie to VSS
17	PA_GAIN[1]	Output	PA gain control of both radio A/B
18	PA_GAIN[0]	Output	PA gain control of both radio A/B
19	RADIO_B_CS	Output	Radio B SPI interface
20	RADIO_B_MOSI	Output	Radio B SPI interface
21	RADIO_B_MISO	Input	Radio B SPI interface
22	RADIO_B_SCK	Output	Radio B SPI interface
23	VCC18	Power (VCC)	Logic core supply
24	VSS	Power (GND)	Ground
25	RADIO_RST	Output	Radio A/B global reset
26	PA_B_CTRL	Output	PA B enable
27	LNA_B_CTRL	Output	LNA B enable
28	RADIO_B_EN	Output	Radio B global enable
29	VCC33	Power (VCC)	Logic IO supply
30	VSS	Power (GND)	Ground
31	VSS	Power (GND)	Ground
32	NC		Not connected – tie to VSS
33	NC		Not connected – tie to VSS
34	SP_VALID	Input	Radio C sample valid
35	B_IQ_RX	Input	Radio B 1 bit I/Q Rx samples
36	B_QI_RX	Input	Radio B 1 bit Q/I Rx samples
37	B_IQ_TX	Output	Radio B 1 bit I/Q Tx samples
38	B_QI_TX	Output	Radio B 1 bit Q/I Tx samples
39	SP_CLK_OUT	Output	Radio C clock out (32 MHz)

Pin	Pin Name	Type	Description
40	GND	Power (GND)	Ground
41	GND	Power (GND)	Ground
42	VCC18	Power (VCC)	Logic core supply
43	CLK32M	Input	32 MHz clock from radios crystal
44	A_IQ_RX	Input	Radio A 1 bit I/Q Rx samples
45	A_QI_RX	Input	Radio A 1 bit Q/I Rx samples
46	A_IQ_TX	Output	Radio A 1 bit I/Q Tx samples
47	A_QI_TX	Output	Radio A 1 bit Q/I Tx samples
48	NC		No connected – tie to VSS
49	NC		No connected – tie to VSS
50	VSS	Power (GND)	Ground
51	VSS	Power (GND)	Ground
52	VCC33	Power (VCC)	Logic IO supply
53	CLKHS	Input	High speed digital clock
54	GPIO[4]	In/Out	General purpose GPIO[4]
55	GPIO[3]	In/Out	General purpose GPIO[3]
56	GPIO[2]	In/Out	General purpose GPIO[2]
57	GPIO[1]	In/Out	General purpose GPIO[1]
58	GPIO[0]	In/Out	General purpose GPIO[0]
59	VSS	Power (GND)	Ground
60	VCC18	Power (VCC)	Logic core supply
61	RADIO_A_SCK	Output	Radio A SPI interface
62	RADIO_A_MISO	Input	Radio A SPI interface
63	RADIO_A_MOSI	Output	Radio A SPI interface
64	RADIO_A_CS	Output	Radio A SPI interface

**Table 1: Pins Name and Description**

## 2 Electrical Characteristics

### 2.1 Absolute Maximum Ratings

Stresses above the values listed below may cause permanent device failure. Exposure to absolute maximum ratings for extended periods may affect device reliability. Operation outside the parameters specified in the Operating Conditions section is not implied.

Parameter	Symbol	Conditions	Value
IO power supply to VSS	$V_{DDIO,ABSMAX}$		-0.5 V to 4.0 V
Core power supply to VSS	$V_{DDCORE,ABSMAX}$		-0.5 V to 2.0 V
Storage temperature	$T_{J,STORE}$		-50 °C to 150 °C
Junction temperature	$T_{J,ABSMAX}$		-40 °C to 125 °C
Pin voltage on IO and Clock pins	$V_{DPIN,ABSMAX}$		-0.3 V to VDDIO + 0.3 V
Peak reflow temperature	$T_{PKG}$		260 °C
Latchup	$I_{LUP}$	JESD78D, class I	+/-100 mA
Humidity	$H_R$		0 – 95 %
ESD	HBM	Human Body Model JESD22-A114 CLASS 2	2 kV
	CDM	Charged Device Model JESD22-C101 CLASS III	300 V

**Table 2: Absolute Maximum Ratings**

### 2.2 Constraints on External

Circuit is expected to be used with the following external conditions.

Parameter	Symbol	Conditions	Min	Typ	Max	Unit
Radio ADC samples clock input frequency	XTAL32F	Clock for data communication with Tx <sup>†</sup>		32		MHz
ADC sample clock frequency tolerance	XTAL32T		-10		+10	ppm
High speed processing clock	HSC_F	Clock for data processing	130	133	150	MHz
Load on IO pins	CLOP		0		25	pF

Notes:

<sup>†</sup> The data communication IOs are A\_I\_RX, A\_Q\_RX, B\_X\_RX, B\_Q\_RX and clock signal is CLK32M

**Table 3: Externals**

### 2.3 Operating Conditions

The circuit will operate full specs within the following operating conditions.

Parameter <sup>†</sup>	Symbol	Conditions	Min	Typ	Max	Unit
Digital IO supply	$V_{DDIO}$	Operating Conditions for Electrical Specification	3.0		3.6	V
Digital core supply	$V_{DDCORE}$	Operating Conditions for Electrical Specification	1.75		1.85	V
Ambient operating temperature	$T_A$	With chip paddle soldered to PCB ground plan with minimum 100 cm <sup>2</sup> air exposed area and heat sink	-40		85	°C

**Table 4: Operating Conditions for Electrical Specifications**

## 2.4 Electrical Specifications

The table below gives the specifications of the circuit within the Operating Conditions as indicated in 2.3 unless otherwise specified.

Parameter	Symbol	Conditions	Min	Typ	Max	Unit
<b>Current Consumption</b>						
Current in idle mode	$I_{VDDCORE,IDLE}$	1.8V supply current in Idle mode <sup>1</sup>		120	5000	uA
	$I_{VDDIO,IDLE}$	3.3V supply current in idle mode		1	2	uA
Current in medium active	$I_{VDDCORE,MED}$	1.8V supply current with 4 active paths		330	550	mA
	$I_{VDDIO,MED}$	3.3V supply current with 4 active paths – no load		5	10	mA
Current in full active	$I_{VDDCORE,FULL}$	1.8V supply current with 8 active paths		550	750	mA
	$I_{VDDIO,FULL}$	3.3V supply current with 8 active paths – no load		5	10	mA
<b>IO Pins levels</b>						
Logic low input threshold	VIL	“0” logic input	0.4			V
Logic high input threshold	VIH	“1” logic input			$V_{DDIO} - 0.4$	V
Logic low output level	VOL	“0” logic output, 2 mA sink	VSS		$VSS + 0.4$	V
Logic high output level	VOH	“1” logic output, 2 mA source	$V_{DDIO} - 0.4$		$V_{DDIO}$	V

**Table 5: Electrical Specifications**

## 2.5 Timing Specifications

The table below gives the specifications of the circuit within the Operating Conditions as indicated in 2.3 unless otherwise specified. See chapters 3.4 and 3.5 for timing diagrams and symbol definitions.

Parameter	Symbol	Conditions	Min	Typ	Max	Unit
<b>SPI</b>						
SCK frequency	$F_{SCK}$		-	-	10	MHz
SCK high time	$t_{ch}$		50	-	-	ns
SCK low time	$t_{cl}$		50	-	-	ns
SCK rise time	$t_{rise}$		-	5	-	ns
SCK fall time	$t_{fall}$		-	5	-	ns
MOSI setup time	$t_{setup}$	From MOSI change to SCK rising edge.	10	-	-	ns
MOSI hold time	$t_{hold}$	From SCK rising edge to MOSI change.	20	-	-	ns
CSN setup time	$t_{nsetup}$	From CSN falling edge to SCK rising edge	10	-	-	ns
CSN hold time	$t_{nhold}$	From SCK falling edge to CSN rising edge, normal mode	40	-	-	ns
CSN high time between SPI accesses	$t_{nhigh}$		40	-	-	ns
<b>Clock to Rx I-Q data</b>						
Rx IQ hold and setup time	$t_{IQ}$		2	-	-	ns

**Table 6: Timing Specifications**

<sup>1</sup> Idle current is reached following procedure indicated in application part of datasheet (chapter 3.2.2)



### 3 Circuit Operation

This chapter is for information only.

#### 3.1 General Presentation

The SX1301 is a smart baseband processor for long range ISM communication. In the receiver part, it receives I and Q digitized bitstream from one or two receivers (SX1257 as an example), demodulates these signals using several demodulators, adapting the demodulators settings to the received signal and stores the received demodulated packets in a FIFO to be retrieved from a MCU. In the transmitter part, the packets are modulated using a programmable (G)FSK/LoRa modulator and sent to one transmitter (SX1257 as an example). Received packets can be time-stamped using a GPS input.

The SX1301 has an internal control block that receives microcode from the MCU. The microcode is provided by Semtech as a binary file to load in the SX1301 at power-on (see Semtech application support for more information).

The control of the SX1301 by the MCU is made using a Hardware Abstraction Layer (HAL). The Hardware Abstraction Layer source code is provided by Semtech and can be adapted by the MCU developers. It is recommended to fully re-use the latest HAL as provided by Semtech on [https://github.com/Lora-net/lora\\_gateway](https://github.com/Lora-net/lora_gateway).

#### 3.2 Power-on

##### 3.2.1 Power-up Sequence

Power-up sequence must follow the timing indicated in the figure below.

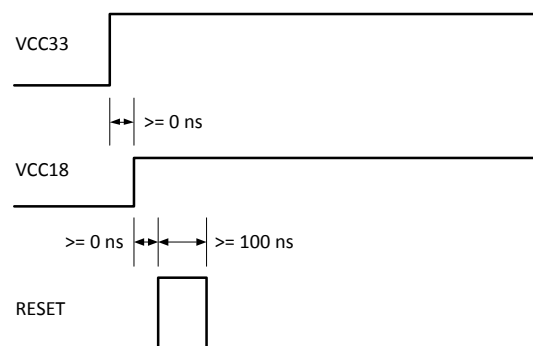

**Figure 2: Power-up Sequence**

##### 3.2.2 Setting the Circuit in Low-power Mode

At power up, the circuit is in a general low-power state but some registers linked to the memory are in undefined state. To set the circuit in low-power mode, the following instructions and clocks must be provided to the circuit.

```
// Setting circuit in low-power mode after power-up
// spi_write(x, y) is a write of data "y" on address "x" on HOST SPI bus
spi_write(0,128);  Reset On
spi_write(0,0);   Reset Off
// provide at least 16 cycles on CLKHS and 16 cycles CLK32M
spi_write(18,1);  BIST 1
// provide at least 4 cycles on CLKHS and 32 cycles CLK32M and 4 cycles on HOST_SCK
spi_write(18,2);  BIST 2
```

```
// provide at least 4 cycles CLK32M and 4 cycles on HOST_SCK  
spi_write(0,128);  Reset On  
spi_write(0,0);   Reset Off
```

**Idle Mode Sequence after Power-up**

### 3.3 Clocking

The SX1301 gateway requires two clocks.

- A 32MHz clock synchronous with the ADC samples. This clock is used to internally sample the ADC samples and clock all the decimation filters. When the SX1301 is used with a Semtech S1257 or SX1255 RF front-end, this clock is provided by the radio. This clock uses CMOS levels (0 – 3.3 V). If a third party radio front-end is used, this must be the clock that also clocks the ADCs and serves as a reference for the radio PLLs.
- A high speed clock whose frequency can be anywhere in the range 130 - 150 MHz. This clock uses CMOS level and must be provided from an external Oscillator. There is no constraint on this clock jitter. This clock is used for most of the demodulation blocks and data processing. This clock is never used by any of the analog/radio blocks.

### 3.4 SPI Interface

The SPI interface gives access to the configuration register via a synchronous full-duplex protocol. Only the slave side is implemented.

Three access modes to the registers are provided:

- **SINGLE access:** an address byte followed by a data byte is sent for a write access whereas an address byte is sent and a read byte is received for the read access. The CSN pin goes low at the beginning of the frame and goes high after the data byte.
- **BURST access:** the address byte is followed by several data bytes. The address is automatically incremented internally between each data byte. This mode is available for both read and writes accesses. The CSN pin goes low at the beginning of the frame and stay low between each byte. It goes high only after the last byte transfer.
- **FIFO access:** if the address byte corresponds to the address of the FIFO, then succeeding data byte will address the FIFO. The address is not automatically incremented but is memorized and does not need to be sent between each data byte. The CSN pin goes low at the beginning of the frame and stay low between each byte. It goes high only after the last byte transfer.

The figure below shows a typical SPI single access to a register.

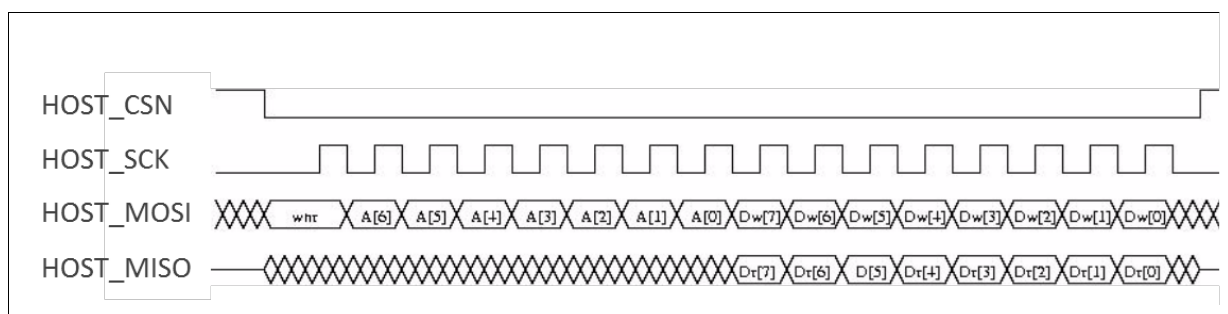

**Figure 3: SPI Timing Diagram (Single Access)**

MOSI is generated by the master on the falling edge of SCK and is sampled by the slave (i.e. this SPI interface) on the rising edge of SCK. MISO is generated by the slave on the falling edge of SCK.

MISO is always low impedance so it cannot be shared with another device.

A transfer is always started by the CSN pin going low.

The first byte is the address byte. It is comprises:

- one wnr bit, which is “1” for write access and “0” for read access.
- then seven bits of address, MSB first.

The second byte is a data byte, either sent on MOSI by the master in case of a write access or received by the master on MISO in case of read access. The data byte is transmitted MSB first.

Proceeding bytes may be sent on MOSI (for write access) or received on MISO (for read access) without a rising CSN edge and re-sending the address. In FIFO mode, if the address was the FIFO address then the bytes will be written / read at the FIFO address. In Burst mode, if the address was not the FIFO address, then it is automatically incremented for each new byte received.

The frame ends when CSN goes high. The next frame must start with an address byte. The SINGLE access mode is therefore a special case of FIFO / BURST mode with only 1 data byte transferred.

During the write access, the byte transferred from the slave to the master on the MISO line is the value of the written register before the write operation.

### 3.5 Rx I/Q Interface

The Rx I/Q bit stream has to be generated relative to the radio clock (32 MHz).

The SX1301 can manage I/Q generated on both clock rising and falling edges.

#### 3.5.1 I/Q Generated on Clock Rising Edge

To relax the constraint on setup and hold time, it is recommended to use the falling edge of the clock.

To avoid internal setup and hold violation, it is mandatory to avoid I/Q change in a range of +/- 2 ns around clock falling edge

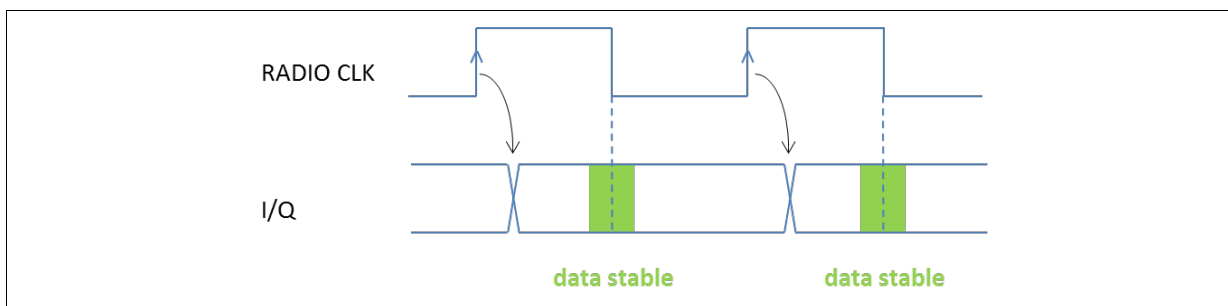

Figure 4: I/Q on Clock Rising Edge

#### 3.5.2 I/Q Generated on Clock Falling Edge

To relax the constraint on setup and hold time, it is recommended to use the rising edge of the clock

To avoid internal setup and hold violation, it is mandatory to avoid I/Q change in a range of +/- 2 ns around clock rising edge

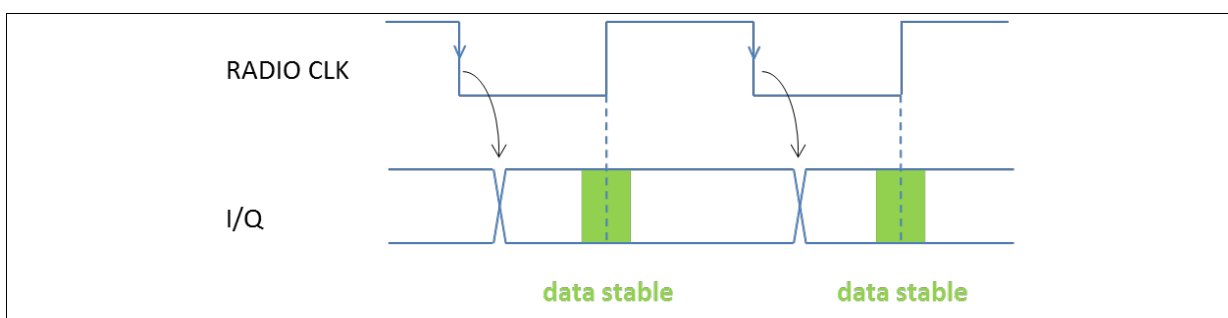
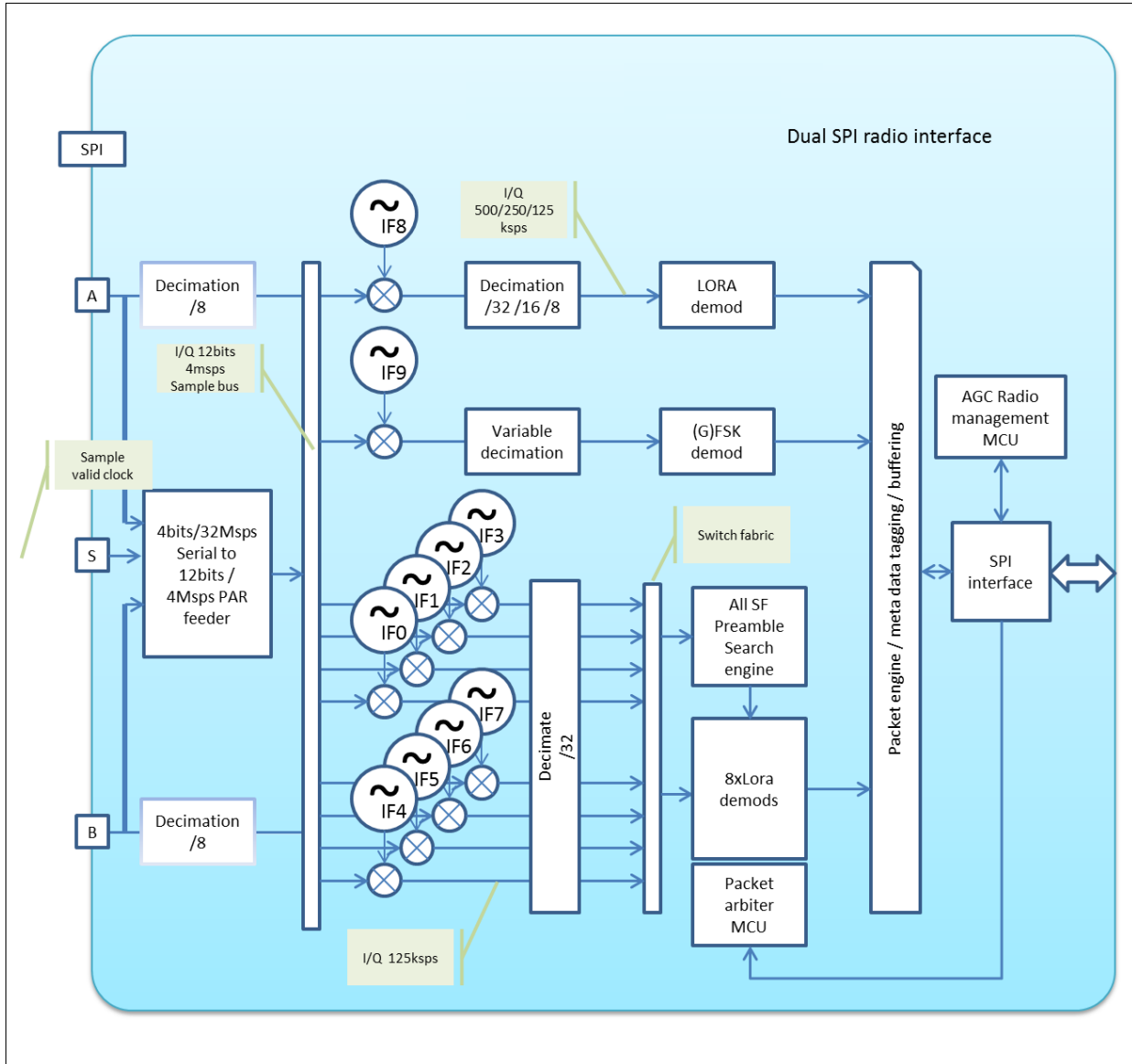

Figure 5: I/Q on Clock Falling Edge

**3.6 RX Mode Block Diagram, Reception Paths Characteristics**
**3.6.1 Block Diagram**

**Figure 6: SX1301 Digital Baseband Chip Block Diagram**

All chip functionalities can be accessed through a single high speed SPI interface.

The chip integrates two dedicated micro-controllers.

1. A radio AGC MCU. Handling the real time automatic gain control of the entire chain. For this purpose this MCU can control the two radio front-ends through a dedicated SPI master interface. This MCU also handles radio calibration and RX<->TX radio switch
2. A packet arbiter MCU. Assigning the available LoRa modems to the various reception paths. This arbiter can be configured to follow different priority rules based on parameters like data rate of the incoming packet, channel, radio path or signal strength of the incoming packet.

The firmware of those 2 MCUs can be fully programmed at any time through the HOST SPI interface. This firmware is embedded in the Hardware Abstraction Layer provided by Semtech and does not need to be developed by the user.

### 3.6.2 Reception Paths Characteristics

The SX1301 digital baseband chip contains 10 programmable reception paths. Those paths have differentiated levels of programmability and allow different use cases. It is important to understand the differences between those demodulation paths to make the best possible use from the system.

#### IF8 LoRa Channel

This channel can be connected to Radio A or B using any arbitrary intermediate frequency within the allowed range. This channel is LoRa only. The demodulation bandwidth can be configured to be 125, 250 or 500 kHz. The data rate can be configured to any of the LoRa available data rates (SF7 to SF12) but, as opposed to IF0 to 7, ONLY the configured data rate will be demodulated. This channel is intended to serve as a high speed backhaul link to other gateways or infrastructure equipment. This demodulation path is compatible with the signal transmitted by the SX1272 & SX1276 chip family. Chapter 3.12 gives a brief overview of the expected system sensitivity in LoRa mode

#### IF9 (G)FSK Channel

Same as previous except that this channel is connected to a GFSK demodulator. The channel bandwidth and bitrate can be adjusted. This demodulator offers a very high level of configurability, going well beyond the scope of this document. The demodulator characteristics are essentially the same than the GFSK demodulator implemented on the SX1232 and SX1272 Semtech chips.

This demodulation path can demodulate any legacy FSK or GFSK formatted signal.

#### IF0 to IF7 LoRa Channels

Those channels can be connected individually to Radio A or B. The channel bandwidth is 125 kHz and cannot be modified or configured. Each channel IF frequency can be individually configured. On each of those channels any data rate can be received without prior configuration. Several packet using different data rates may be demodulated simultaneously even on the same channel. Those channels are intended to be used for a massive asynchronous star network of 10000's of sensor nodes. Each sensor may use a random channel (amongst IF0 to 7) and a different data rate for any transmission.

Typically sensor located near the gateway will use the highest possible data rate in the fixed 125 kHz channel bandwidth (e.g. 6 kbit/s) while sensors located far away will use a lower data rate down to 300 bit/s (minimum LoRa data rate in a 125 kHz channel).

The SX1301 digital baseband chip scans the 8 channels (IF0 to IF7) for preambles of all data rates at all times. The chip is able to demodulate simultaneously up to 8 packets. Any combination of up to 8 packets is possible (e.g. one SF7 packet on IF0, one SF12 packet on IF7 and one SF9 packet on IF1 simultaneously).

The SX1301 can detect simultaneously preambles corresponding to all data rates on all IF0 to IF7 channels. However it cannot demodulate more than 8 packets simultaneously. This is because the SX1301 architecture separates the preamble detection and acquisition task from the demodulation process. The number of simultaneous demodulation (in this case 8) is an arbitrary system parameter and may be set to any value for a customer specific circuit.

The unique multi data-rate multi-channel demodulation capacity of channels 0 to 7 allow innovative network architecture to be implemented:

- End-point nodes can change frequency with each transmission in a random pattern. This provides vast improvement of the system in term of interferer robustness and radio channel diversity

- End-point nodes can dynamically perform link rate adaptation based on their link margin without adding to the protocol complexity. There is no need to maintain a table of which end point uses which data rate, because all data rates are demodulated in parallel.
- True antenna diversity can be achieved on the gateway side. Allows better performance for mobile nodes in difficult multi-path environments.

### 3.7 Packet Engine and Data Buffers

#### 3.7.1 Receiver Packet Engine

Each time any of the demodulators decodes a packet, it is tagged with some additional information and stored in a shared data buffer (the data buffer size is 1024 bytes). For this purpose a specific data buffer management block reserves a segment with the necessary length in the data buffer and at the same time, stores the start address and the length of the packet field in a small FIFO type structure (named the access FIFO). The FIFO can contain up to 16 (start\_addr, length) pairs.

A status register contains at any moment the number of packets currently stored in the data buffer (and in the access FIFO).

To retrieve a packet, the host micro-controller first advances 1 step in the access FIFO by writing 1 to the 'next' bit. Then reads the (start\_addr, length) information. The host micro-controller can now retrieve in one SPI burst operation the entire packet and associated meta-data by reading 'length'+16 bytes starting at address 'start\_addr' in the data buffer .. To do so, first position the HOST address pointer to 'start-addr', then read 'length' + 16 bytes from the 'packet\_data' register. At the end of each byte the HOST address pointer is automatically incremented.

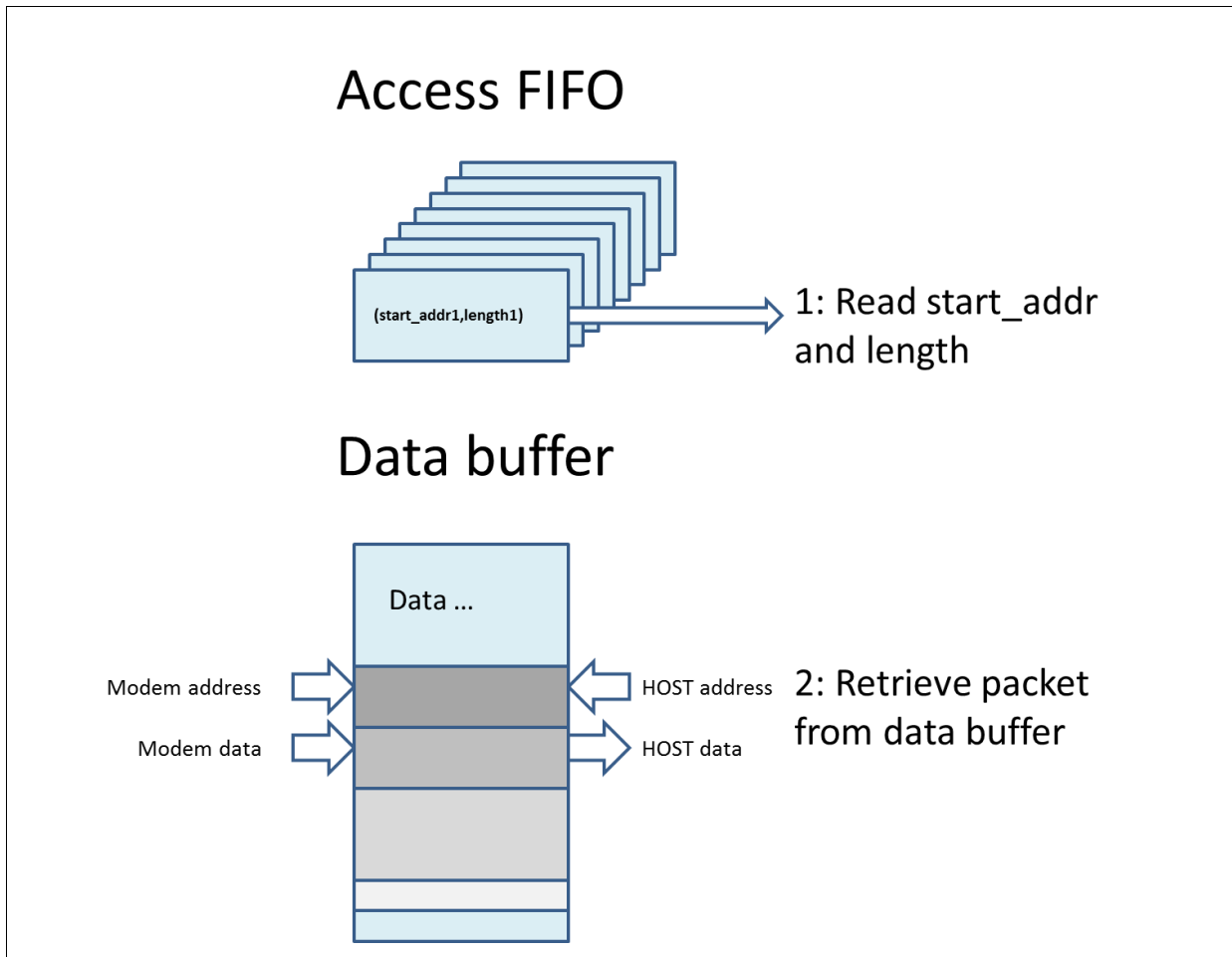

**Figure 7: Access FIFO and Data Buffer**

The packet data is organized as follows:

Packet buffer data organization

Offset from start pointer	Data stored	Comment
0	PAYLOAD	PAYLOAD DATA
...		
...		
...		
...		
payload_size-1	CHANNEL SF[3:0],CR[2:0],CRC_EN SNR AVERAGE SNR MIN SNR MAX	1 to 10 as described by block diagram
payload_size		averaged SNR in dB on the packet length
1+payload_size		minimum SNR (dB) recorded during packet length
2+payload_size		maximum SNR recorded during packet length
3+payload_size		
4+payload_size		



5+payload_size	RSSI	channel signal strength in dB averaged during packet
6+payload_size	TIMESTAMP[7:0]	
7+payload_size	TIMESTAMP[15:8]	
8+payload_size	TIMESTAMP[23:16]	32 bits time stamp , 1 us step
9+payload_size	TIMESTAMP[31:24]	
10+payload_size	CRC_VALUE[7:0]	
11+payload_size	CRC_VALUE[15:8]	value of the computed CRC16
12+payload_size	MODEM ID	
13+payload_size	RX_MAX_BIN_POS[7:0]	
14+payload_size	RX_MAX_BIN_POS[15:8]	Correlation peak position
15+payload_size	RX_CORR_SNR	Detection correlation SNR
16+payload_size	Reserved	
17+payload_size	Reserved	

**Table 7: Packet Data Fields**

This means that the host micro-processor has to read 16 additional bytes on top of each packet to have access to all the meta-data. If the host is only interested in the payload itself + the channel and the data rate used , then payload + 2bytes is enough.

### 3.7.2 Transmitter Packet Engine

The SX1301 gateway transmitter can be used to send packets. The following parameters can be dynamically programmed with each packet:

- Radio channel
- FSK or LoRa modulation
- Bandwidth, data rate, coding rate (in LoRa mode), bit rate and Fdev (in FSK mode)
- RF output power
- Radio path (A or B)
- Time of departure (immediate or differed based on the gateway hardware clock with 1us accuracy)

All those dynamic parameter fields are sent alongside the payload in the same data buffer.

The data buffer can only hold a single packet at a time (next packet to be sent). The scheduling and ordering task is let to the host micro-processor.

The host micro-processor can program the exact time of departure of each packet relative to the gateway hardware clock. The same clock is used to tag each packet received with a 32bits timestamp. The same 32bits time stamp principle is used in TX mode to indicate when to transmit exactly. This removes the real time constraint from the host micro-processor and allows very precise protocol timing.( For example, if the protocol running on the end point expects and acknowledge exactly one sec after the end of each packet of its uplink). The host micro-processor pulls the uplink packet from the RX packet engine, realizes that it must send an acknowledge, takes the uplink packet time stamp, simply increments it by 1 sec and uses that value to program the time of departure of the acknowledge packet. Exactly one second (+/- 1us) after the uplink packet was received, the gateway will transmit the desired acknowledge packet. This allows very tight reception interval windows on the battery powered end points hence improved battery life.

The packet structure for transmission is as follow:

Byte	Subfield	Description	comment
0	23:16	Channel frequency	Fchan/32MHz*2 <sup>19</sup>
1	15:8		
2	7:0		
3	31:24	Start time	Value of the timer at which the modem has to start (in us)
4	23:16		
5	15:8		
6	7:0		
7	7:6	Reserved	
	5:5	Radio select	Select radio A (0) or B (1)
	4:4	Modulation type	0:LoRa, 1:FSK
	3:0	Tx power	>7: 20dBm, otherwise 14dBm
8		Reserved	

**LoRa:**

9	7:7	Payload CRC16 enable	Enables CRC16
	6:4	Coding rate	Coding rate = 4/(4+CR)
	3:0	SF	6 to 12
10	7:0	Payload length	number of bytes
11	7:3	Reserved	
	2:2	Implicit header enable	
	1:0	Modulation bandwidth	2:500, 1:250, 0:125 kHz
12	15:8	Preamble symbol number	Number of symbols in the preamble
13	7:0		
14		Reserved	
15		Reserved	

**FSK:**

9	7:0	FSK frequency deviation	Frequency deviation in KHz
10	7:0	Payload length	number of bytes
11	0	Packet Mode	0 -> fixed length 1 -> variable length
	1	CRC enable	0 -> No CRC 1 -> CRC
	3:2	Dcfree Enc	00 -> DC free encoding off 01 -> Manchester encoding 10 -> Whitening Encoding 11 -> reserved
	4	Crc IBM	0 -> CCITT CRC 1 -> IBM CRC
12	15:8	FSK Preamble Size	The number of preamble bytes sent over the air before the sync pattern.
13	7:0	FSK Preamble Size	
14	15:8	FSK bit rate	Bit rate = 32e6/(FSK bit rate)
15	7:0	FSK bit rate	
16		Payload first byte	Up to 128 bytes

**Table 8: Packet Structure for Transmission**

For words of more than 1 byte, MSBs are sent first.

Bytes 9 to 15 vary depending whether the FSK or the LoRa TX modem is being used.

The user payload starts at byte 16. This is the first byte that will be received by the end point. Bytes 0 to 15 are not transmitted and are just used to dynamically configure the gateway prior to emission.

### 3.8 Receiver IF Frequencies Configuration

Each IF path intermediate frequency can be programmed independently from -2 to +2 MHz. The following sections give a few programming examples for various use cases.

#### 3.8.1 Configuration Using 2 x SX1257 Radios

The SX1257 RX PLLs can be configured to any frequency inside the 868/900 MHz ISM band with a 61 Hz step. The SX1257 streams I/Q samples through a 2 wire digital interface. The bits stream corresponds directly to the I/Q sigma delta ADCs outputs sampled at 32 MSps. This delta sigma stream must be low-passed and decimated to recover the available 80dB dynamic of the ADCs. After decimation the usable spectrum bandwidth is  $\pm 400$  kHz centered on the RX PLL carrier frequency.

The following plot gives the spectral power content of the I/Q bit stream.

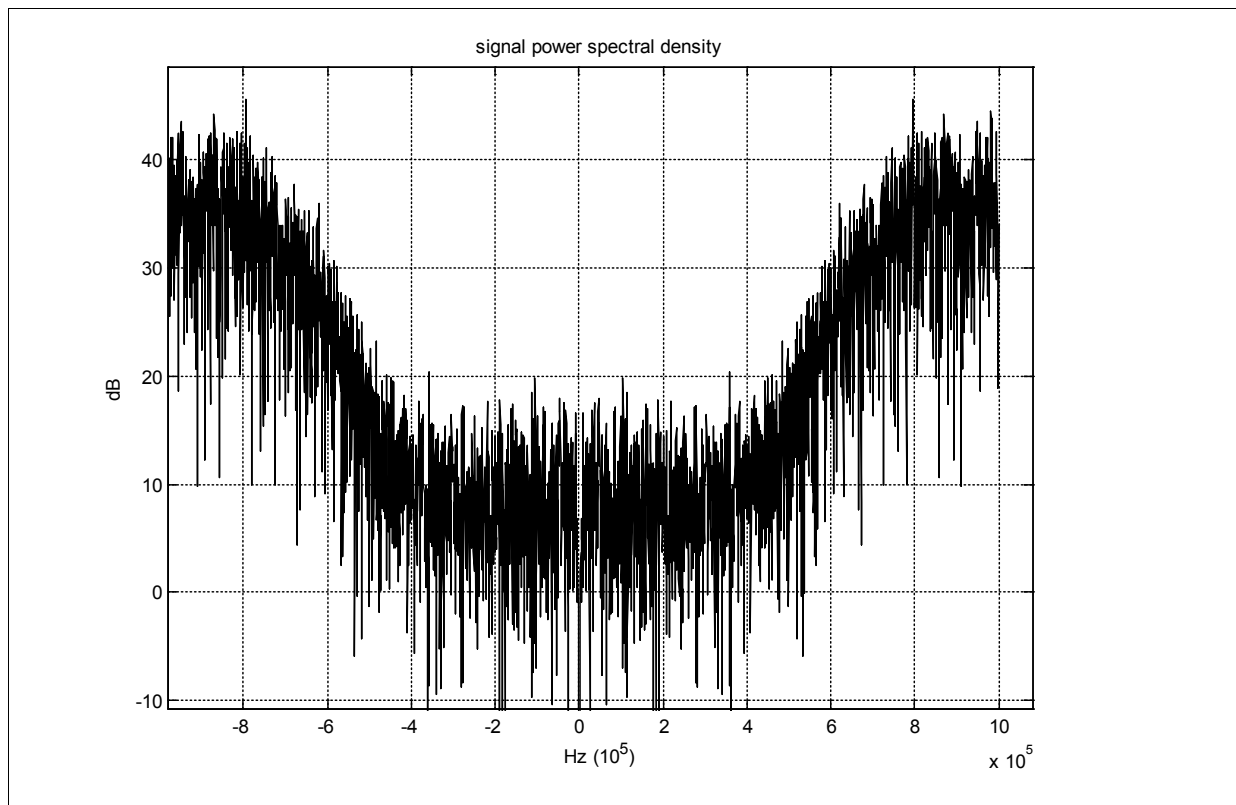
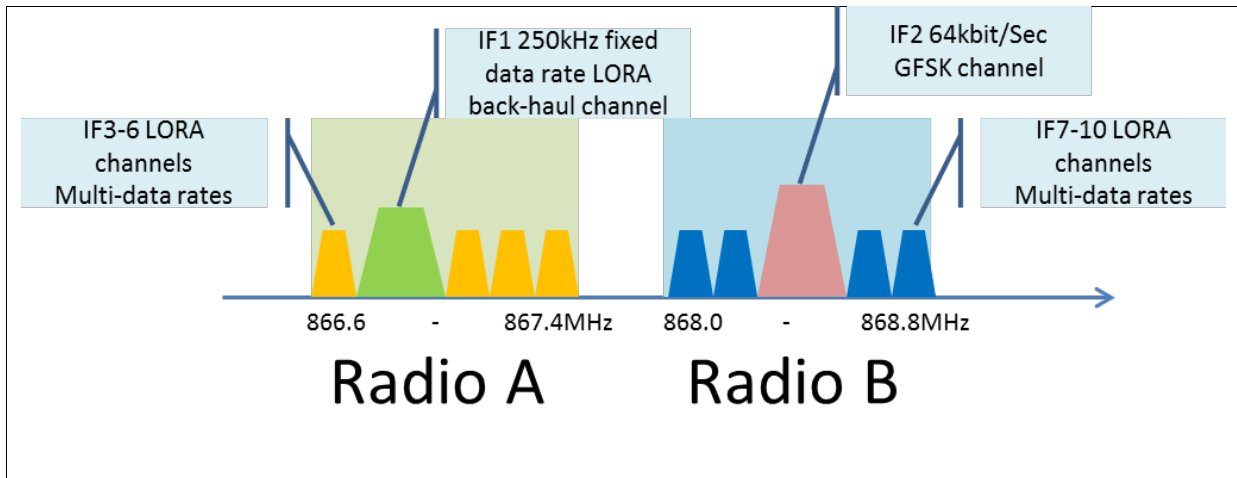

**Figure 8: SX1255/57 Digital I/Q Power Spectral Density**

The quantization noise rises sharply outside the -400 to +400 kHz range. For more details on the SX1257/55 radio specifications please consult the specific product datasheet.

The following plot represents a possible use case where

- Radio A PLL is set to 867.0 MHz
- Radio B PLL is set to 868.4 MHz
- The system uses 8 separate 125 kHz LoRa channels for star connection to sensors
- One high speed 250 kHz LoRa channel for connection to a relay
- One high speed 200 kHz GFSK channel for meshing



**Figure 9: Radio Spectrum**

In the previous example the various IF frequencies would be set as follow:

IF8	A: -125kHz	Lora backhaul , fixed data-rate
IF9	B: 0kHz	GFSK backhaul
IF0	A: -312.5kHz	LoRa multi-data rate channel
IF1	A: 62.5kHz	"
IF2	A: 187.5kHz	"
IF3	A: 312.5kHz	"
IF4	B: -312.5kHz	"
IF5	B: -187.5kHz	"
IF6	B: 187.5kHz	"
IF7	B: 312.5kHz	"

**Table 9: IF Frequencies Set**

If for example, 8 contiguous 125 kHz LoRa channels are desired the following configuration may be used:

- Radio A PLL is set to 867 MHz
- Radio B PLL is set to 876.5 MHz

The two radio baseband spectrum overlap a little bit.

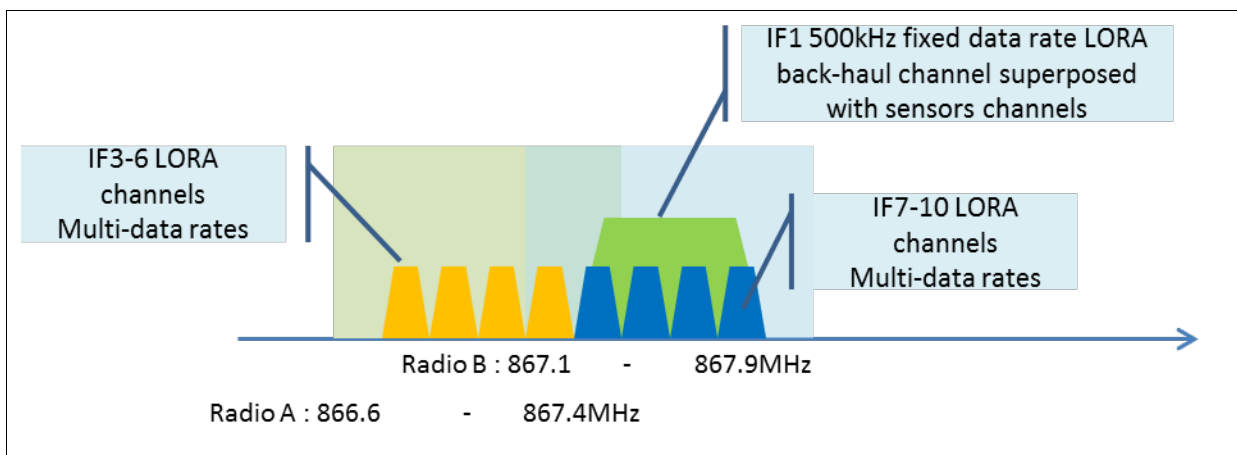

**Figure 10 Radio Spectrum**

The following IF frequencies are used:

IF8	A: 0 kHz	Lora backhaul , fixed data-rate
IF9	Not used	GFSK backhaul
IF0	B: -187.5 kHz	LoRa multi-data rate channel
IF1	B: -62.5 kHz	"
IF2	B: 62.5 kHz	"
IF3	B: 187.5 kHz	"
IF4	A: -187.5 kHz	"
IF5	A: -62.5 kHz	"
IF6	A: 62.5 kHz	"
IF7	A: 187.5 kHz	"

**Table 10: IF Frequency Used**

Note : As shown in this example the 500 or 250 kHz IF1 LoRa channel may overlap with the multi-data rate IF3 to 10 channels. Transmissions happening in the IF7 to 10 channels will be noise like for the IF1 LoRa demodulator and reciprocally. It is however better from a performance point of view to separate as much as possible different channels mainly when the associated signal powers are very different (like between a backhaul link which usually enjoys line-of-sight attenuation and sensor link with very low signal levels).

### 3.8.2 Two SX1255: 433 MHz Band

The circuit will behave exactly as described in the previous section except that everything can be transposed in the 433 MHz ISM band using SX1255 front-end radios instead of SX1257.

### 3.8.3 One SX1257 and one SX1255

In that case dual band simultaneous reception is possible. The following configuration is a typical example of the possible system configuration.

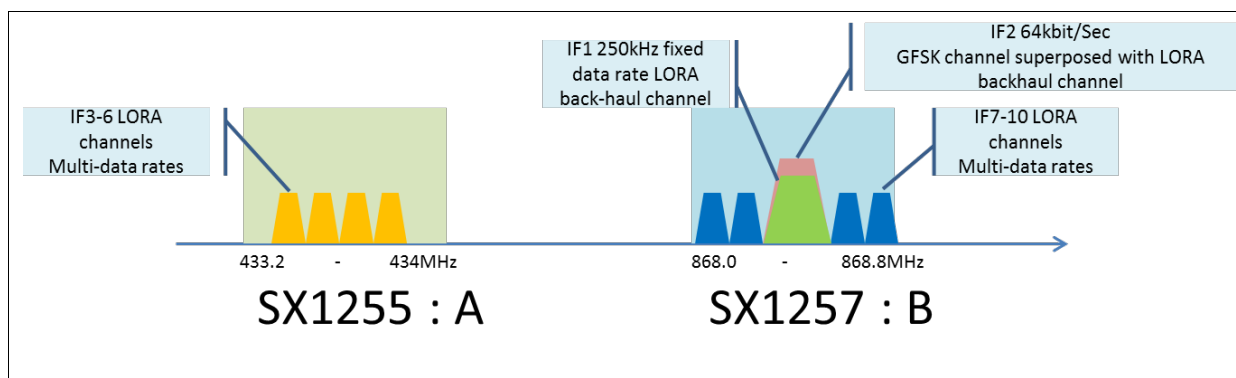
**Figure 11: Radio Spectrum**

- Radio A is an SX1255 configured on 433.6 MHz
- Radio B is a SX1257 configured on 866.4 MHz
- 4 multi data-rates 125 kHz LoRa channel in the low –band
- 4 multi data-rates 125 kHz LoRa channel in the high –band
- One 250 kHz LoRa fixed data-rate channel superposed with a 200 kHz GFSK channel in the high band

As can be seen the system is extremely flexible and allows any arbitrary set of channel configuration.

### 3.9 Connection to RF Front-end

#### 3.9.1 Connection to Semtech SX1255 or SX1257 Components

The SX1301 digital baseband chip is designed to be preferably interfaced with either:

1. 2x SX1257 radio front-ends for the 868 MHz band with antenna diversity support
2. 2x SX1255 radio front-ends for the 433 MHz band with antenna diversity support
3. 1x SX1257 & 1x SX1255 , enabling simultaneous dual-band operation

All modems Intermediate Frequencies may be adjusted independently within the allowed radio baseband bandwidth, e.g.  $\pm 400$  kHz. Optimized firmware is provided to optimally setup the SX1257/55 radios and perform real time automatic gain control.

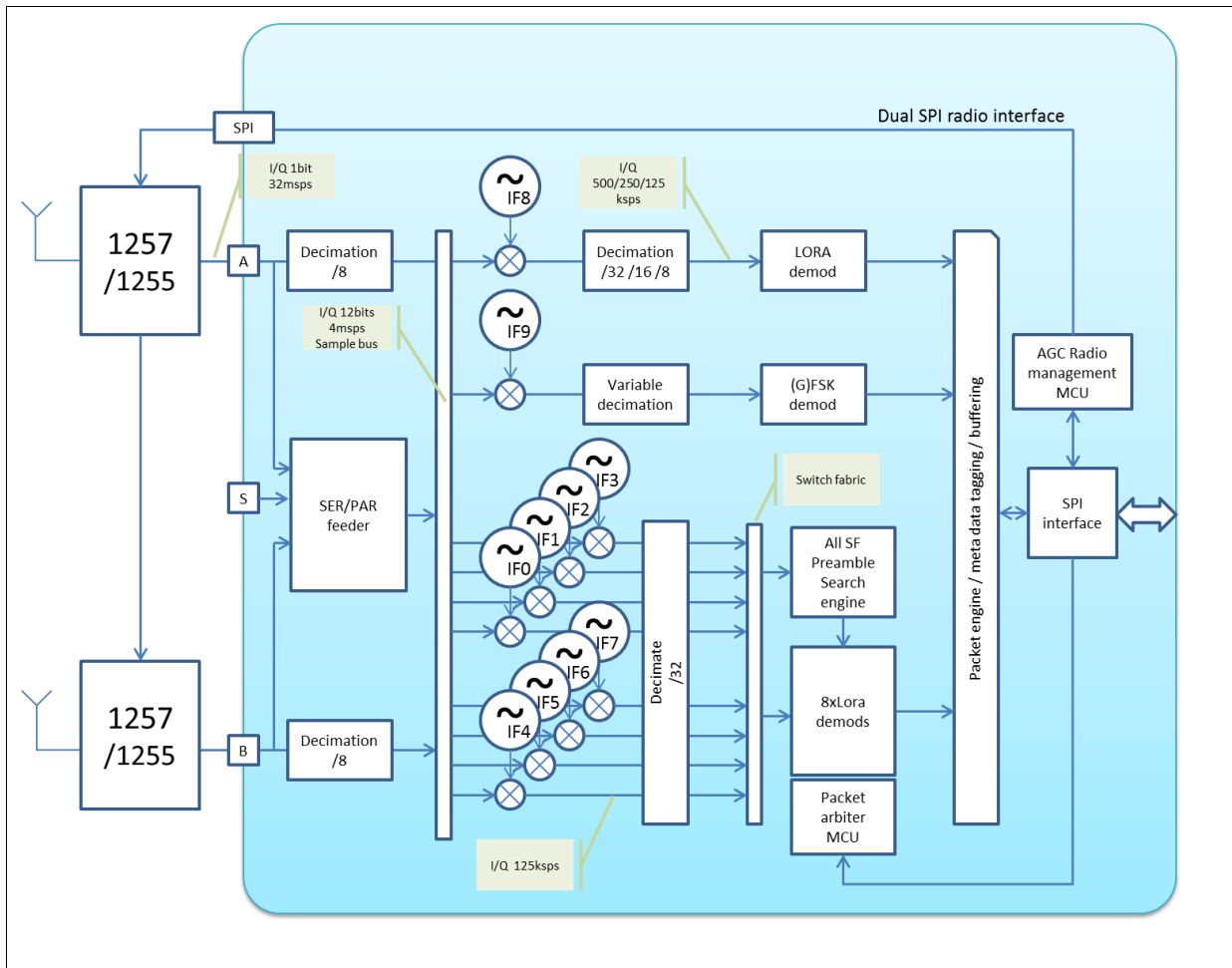

**Figure 12: Dual Band Operation**

#### 3.9.2 SX1301 RX Operation using a Third Party RF Front-end

In that case a third party RF front-end may be used. The digitized I/Q stream must be adapted to the specific format required by the SX1301 digital baseband using an FPGA/CPLD or any other suitable programmable component.

In that mode the SX1301 expects a stream of 4 bits samples at a 32 MSps rate. The “Sample valid” input should pulse every 8 clock cycles to delimit packets of 8 samples. From those 8 samples representing 32 bits, the first 24 MSB are kept as I/Q 12bits sample information and fed to the internal sample 4 MSps sample bus.

All modems Intermediate Frequencies may be adjusted independently within the allowed radio baseband bandwidth up to 2 MHz (third party radio and FPGA/CPLD digital filtering dependent)

The 32 MHz clock input is not represented for the sake of clarity.

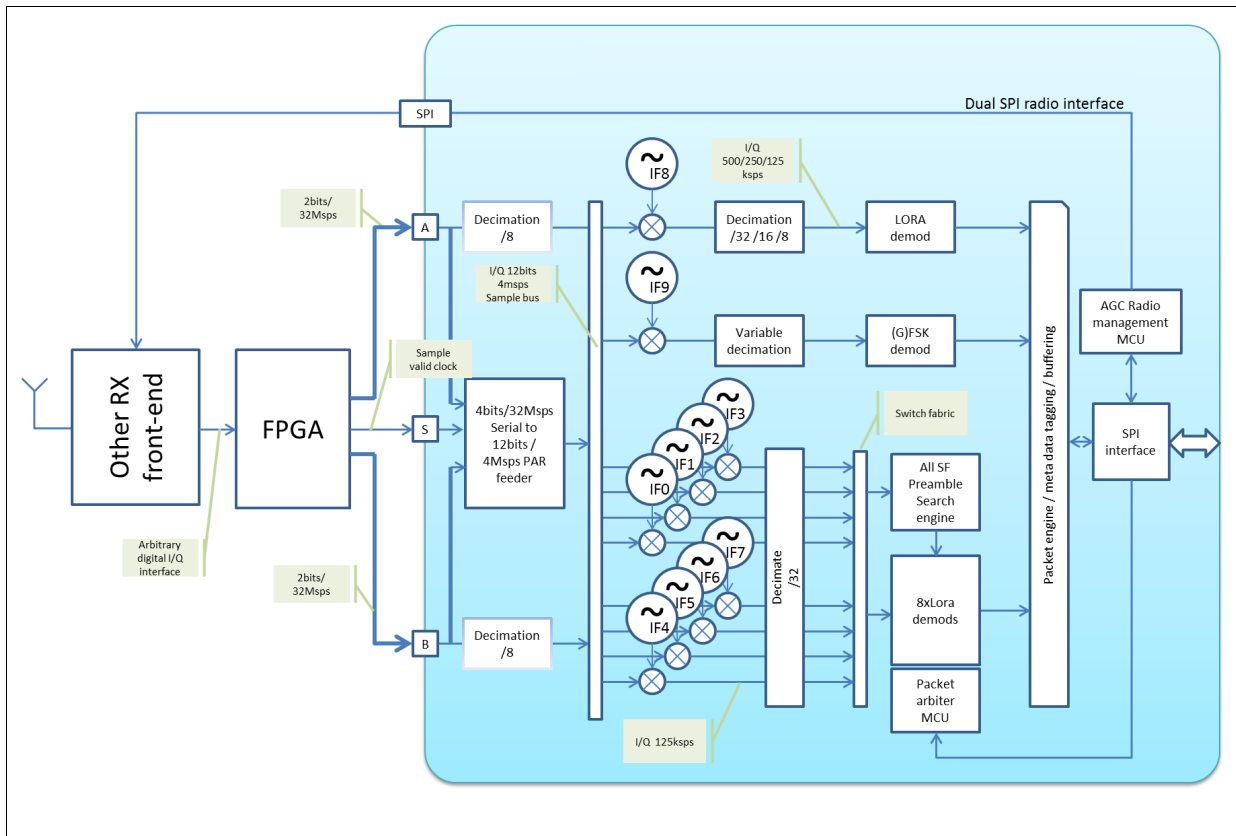

**Figure 13: SX1301 with Third Party Frontend**

The digital interface to third party radio works as follow:

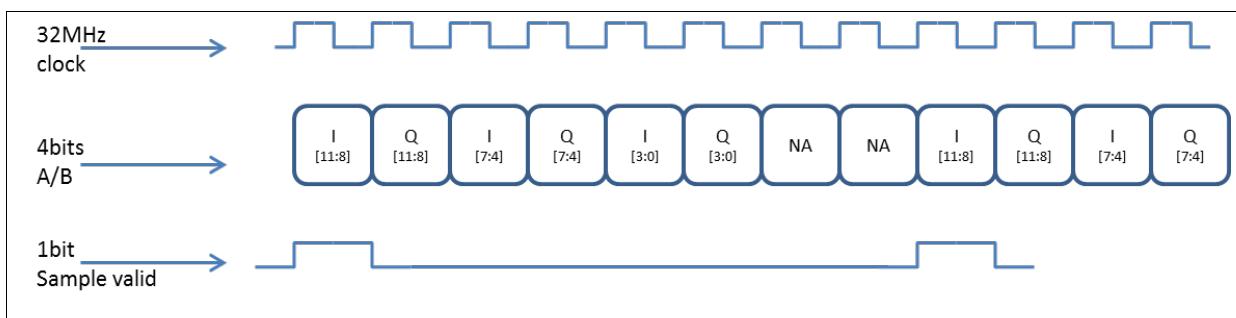

**Figure 14: Digital Interface for Third Party Radio**

The RF front-end must provide a 32 MHz clock. "Sample valid" and data bits must change state on the rising edge of the clock. They are sampled internally in the SX1301 digital IC on the falling edge of the 32 MHz clock.

The "sample valid" signal signals the start of a new I/Q sample. The I/Q 'bits chunks are time interleaved.

When the SX1301 digital baseband chip is connected to a third party radio front-end, the firmware running on the AGC MCU can be changed to perform dynamic gain adaptation of the external radio chip through an SPI interface. The radio SPI interface must fulfill the following conditions:

1. 7 bits address width and 1 W/R bit
2. 8 bits data width

The “Chip select” signal polarity is programmable.

### 3.9.3 Radio Calibration

All calibrations required are performed by uploading the calibration firmware to the integrated radio controller MCU. This specific firmware runs entirely on the SX1301 gateway without intervention of the host micro-processor and performs the following calibrations on both radio channels:

- Carrier leakage cancellation in TX mode
- IQ gain (better than 0.1 dB) and phase imbalance (better than 1 deg) in RX mode

All corrections are applied digitally inside the SX1301 gateway at the appropriate place in the TX & RX processing chains.

During the duration of the calibration (500 ms), no RX or TX operation is possible.

### 3.9.4 SX1301 Connection to RF front-end for TX Operation

In TX mode, the SX1301 digital baseband must be connected either to:

1. At least one SX1255 or SX1257
2. Any combination of both radios

Any LoRa or (G)FSK packet may be transmitted on any of the two radios. Only a single packet may be transmitted at any given time. Transmit operation interrupts all current reception operations.

The digital radio interfaces are separated between RX & TX, therefore the SX1301 may accommodate a third party radio front-end for RX operations and any combination of SX1255/57 for TX operation without problem.



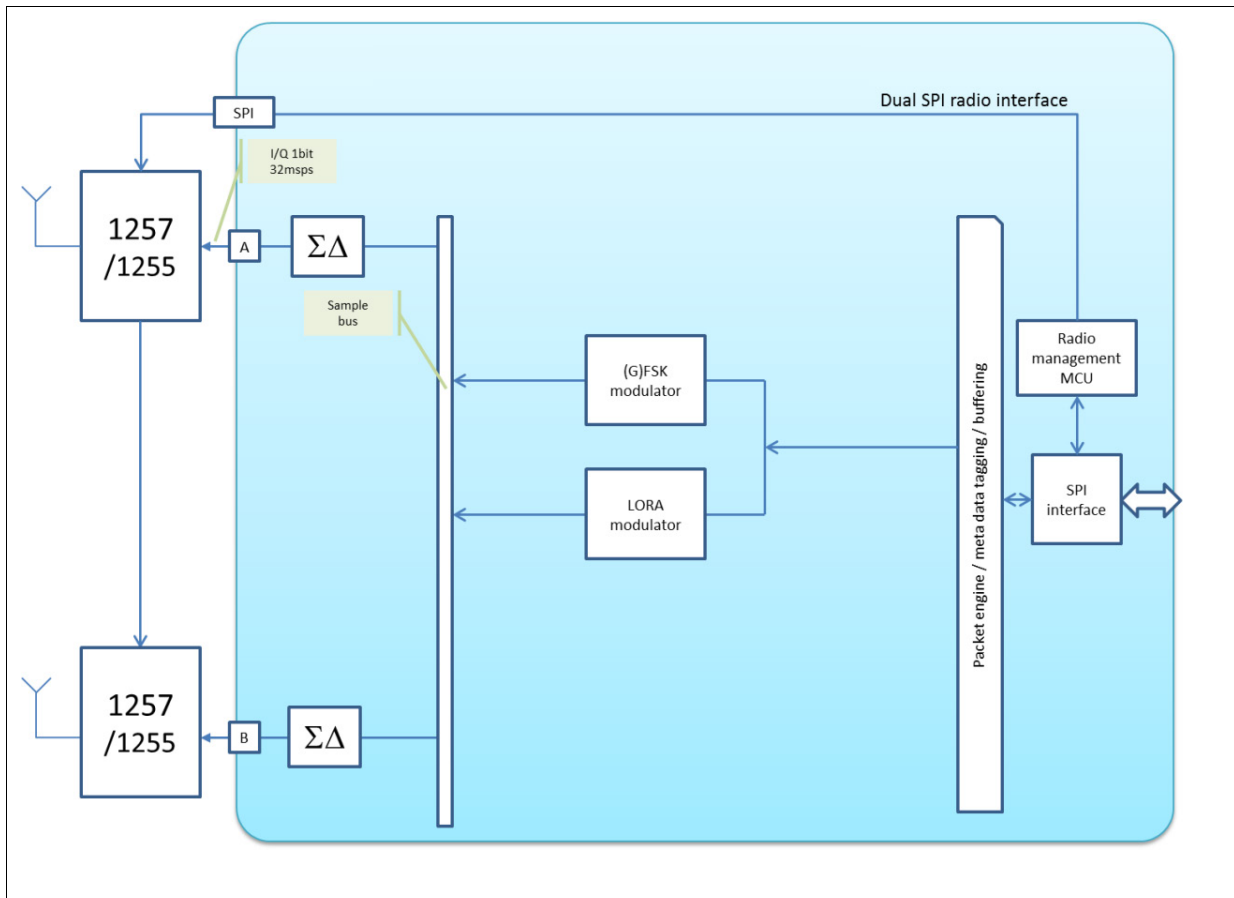

**Figure 15: Transmission Schematics**

A third party radio can be supported for TX operations as well. If the third party radio SPI protocol differs from SX1255/57 then the SPI protocol from SX1301 must be adapted to the specific format required by the third party radio using an FPGA/CPLD or any other suitable programmable component. In that mode the digitized I/Q stream from the SX1301 is a sigma delta 1 bit sample at a 32 MSps rate and must also be adapted to the specific format required by the third party radio using an FPGA/CPLD or any other suitable programmable component.

3.10 Reference Application

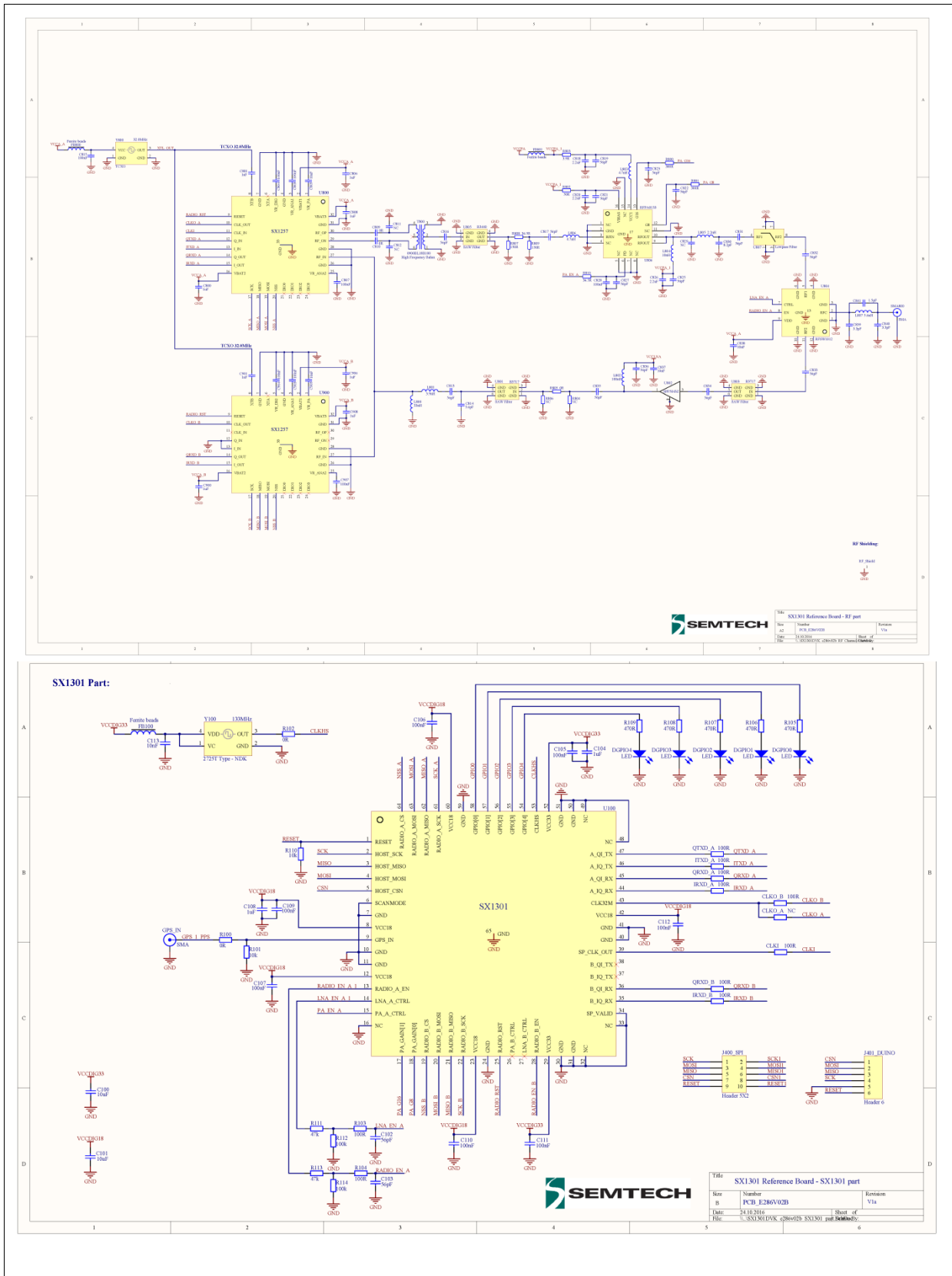

Figure 16: Reference Application

### 3.11 SX1301 Sensitivity Performance in Reference Application

Sensitivities are given for 32 bytes payload, 10% PER.

Symbol	Descriptions	Conditions	Typ	Unit
RFS_SF12_0	LoRa sensitivity at SF12 : IF8 path	BW = 125 kHz BW = 250 kHz BW = 500 kHz	-139.5 -136.5 -133.5	dBm
RFS_SF12_07	LoRa sensitivity at SF12 : IF0 to 7 paths	BW = 125 kHz	-139.5	dBm
ACR_SF12_1M	Receiver CW interferer rejection at 1 MHz offset at SF12	BW = 125 kHz	+80	dB
CCR_SF12	Co-channel rejection at SF12	Wanted signal 10 dB above sensitivity	+25*	dB
RFS_SF7	LoRa sensitivity at SF7 : IF8 path	BW = 125 kHz BW = 250 kHz BW = 500 kHz	-126.5 -123.5 -120.5	dBm
RFS_SF7	LoRa sensitivity at SF7 : IF0 to 7 paths	BW = 125 kHz	-126	dBm
ACR_SF7_1M	Receiver CW interferer rejection at 1 MHz offset	BW = 125 kHz	+70	dB
CCR_SF7	Co-channel rejection at SF7	Wanted signal 10 dB above sensitivity	+9*	dB
RFS_F	FSK sensitivity	FDA = 50 kHz , BT = 100 kb/s	-103	dBm
BRF	Bit rate FSK	Programmable : limited by SSB: FDA + BRF/2 < 250 kHz	1.2 to 100	kb/s
FDA	Frequency deviation, FSK	Programmable	0.6 to 200	kHz

**Note:** \* CCR>0 means that interferer level is greater than wanted signal level. LoRa modulation works with a negative S(N+I)R

**Table 11: SX1301 Performance in Reference Application**

**3.12 SX1301 Sensitivity vs Data Rate in LoRa Mode**

The data rates and sensitivities are only function of the modulation bandwidth and the spreading factor. They are not function of the carrier frequency (868 or 433 MHz)

The sensitivities given are typical measurements done around 867 MHz using a SX1257 front-end with an external low-noise amplifier, SAW filter, and TRX switch as described in the “reference design” section.

Others RF front-end can be supported for future gateways generation. The sensitivity of a receiver can be then calculated as follow:

$$\text{Sensitivity (dBm)} = -174 + 10\log_{10}(BW) + SNR + NF \quad \text{with}$$

- “-174” = due to thermal noise in 1 Hz of bandwidth and can only be influenced by changing the temperature of the receiver, in dBm
- “BW” = receiver bandwidth, in Hz
- “SNR” = minimum ratio of wanted signal power to noise that can be demodulated, in dB
- “NF” = receiver Noise Figure, in dB

The noise figure is the amount of noise power added by the RF front-end in the receiver to the thermal noise power from the input of the receiver. The overall noise figure of cascaded RF stages (such as external amplifier, filter, switch, IC RF receiver chain, ...) is given by the Friis formula:

$$F_{total} = F_1 + \frac{F_2 - 1}{G_1} + \dots + \frac{F_N - 1}{G_1 G_2 \dots G_{N-1}}$$

$$NF (dB) = 10\log_{10}(F_{total})$$

with  $F_{1..N}$  is the linear noise figure and  $G_{1..N-1}$  is the linear gain of the respective cascaded 1<sup>st</sup> to N<sup>th</sup> RF stages.

**3.12.1 125kHz Mode: IF8, IF[0 to 7] Paths**

SF	Data rate (bit/sec)	Sensitivity (dBm)
7	5469	-126.5
8	3125	-129.0
9	1758	-131.5
10	977	-134.0
11	537	-136.5
12	293	-139.5

**Table 12: Sensitivity with 125 kHz Mode**

**3.12.2 250 & 500 kHz Mode: IF8 only**

SF	Data rate (bit/sec)	Sensitivity (dBm)
7	10938	-123.5
8	6250	-126.0
9	3516	-128.5
10	1953	-131.0
11	1074	-133.5
12	586	-136.5

**Table 13: Sensitivity with 250 kHz Mode**

SF	Data rate (bit/sec)	Sensitivity (dBm)
7	21875	-120.5
8	12500	-123.0
9	7031	-125.5
10	3906	-128.0
11	2148	-130.5
12	1172	-133.5

**Table 14: Sensitivity with 500 kHz Mode**
**3.13 SX1301 Interference Rejection**

The following graphs show typical measurement results at 870 MHz with 125 kHz bandwidth measured on the SX1301 with the documented front-end “reference design”.

The frequency asymmetry in the interferer rejection comes from the SAW filter transfer function. This measure is taken on the upper-most channels of the design; therefore the SAW filter starts to attenuate interferences above the wanted signal frequencies. The interferer rejection is arbitrarily limited to 100dB by the measurement setup.

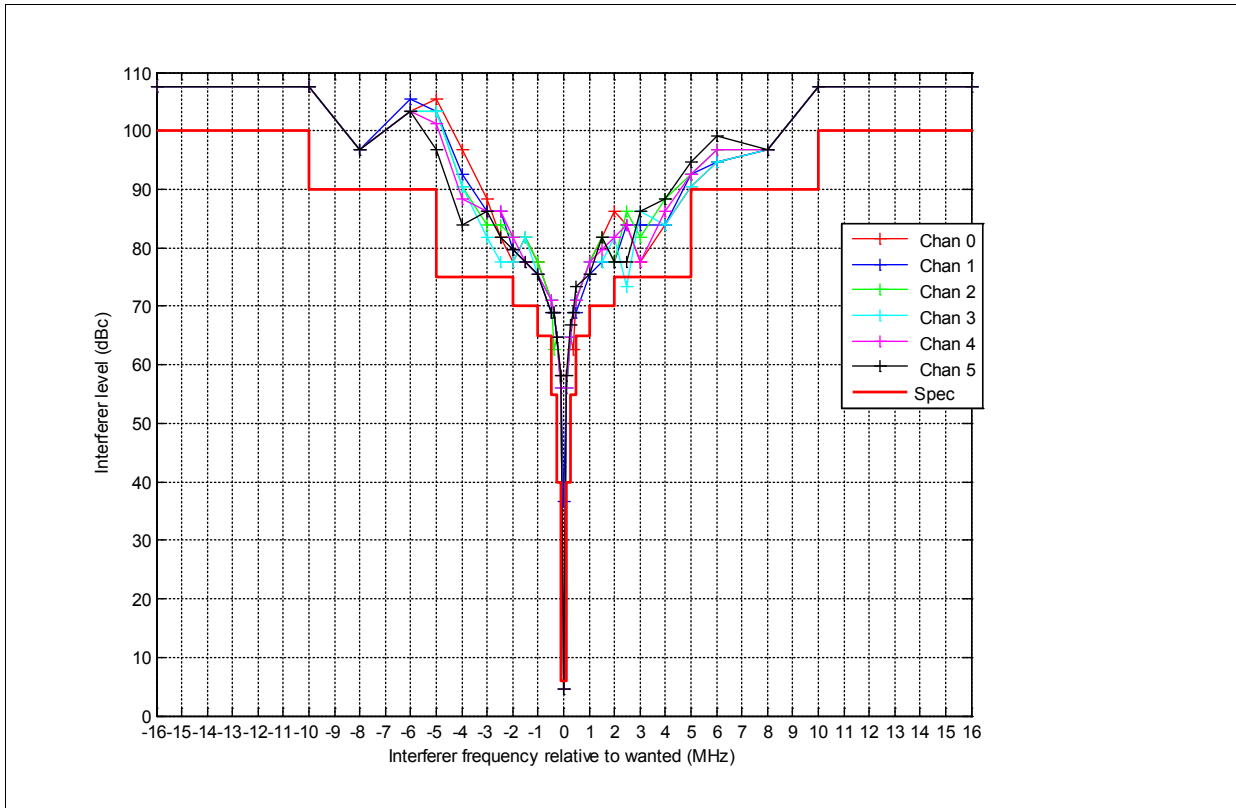

**Figure 17: CW Interferer Rejection at SF7 for 50% PER at Sensitivity + 3dB**

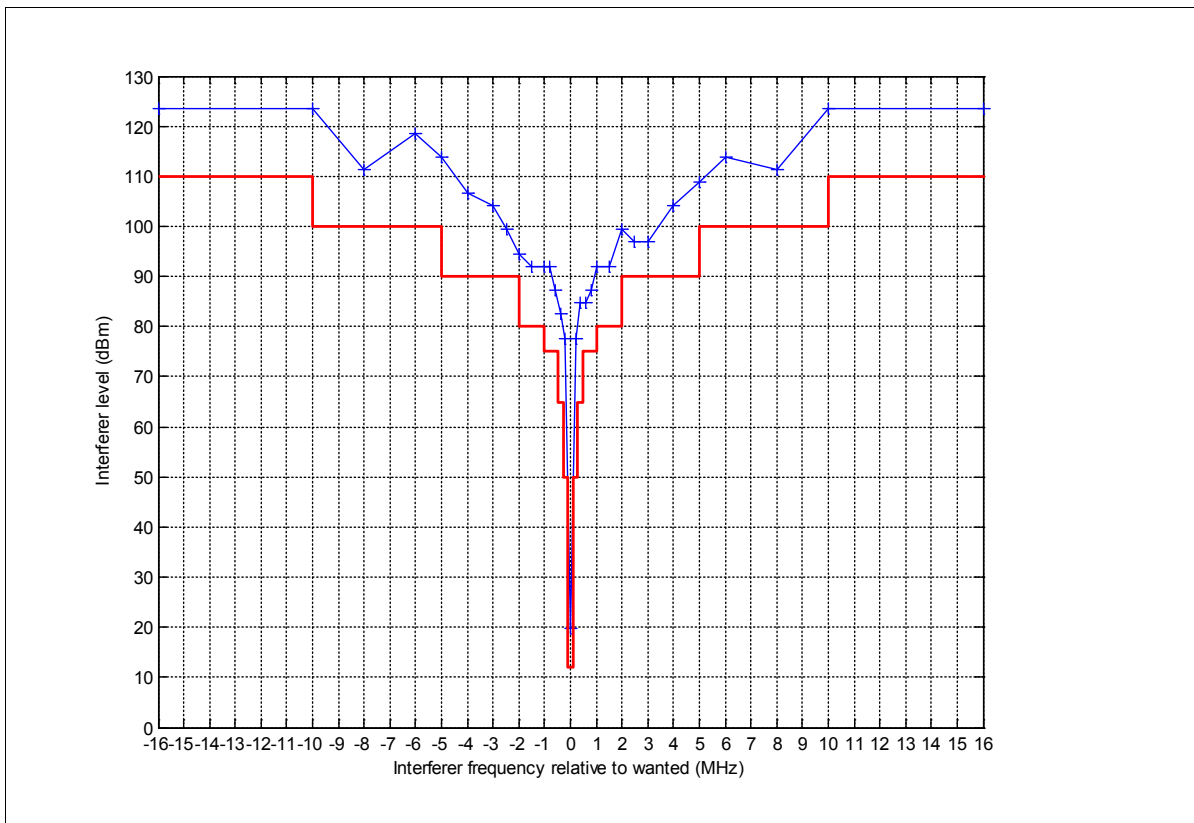

**Figure 18: CW Interferer Rejection at SF12 for 50% PER at Sensitivity + 3dB**

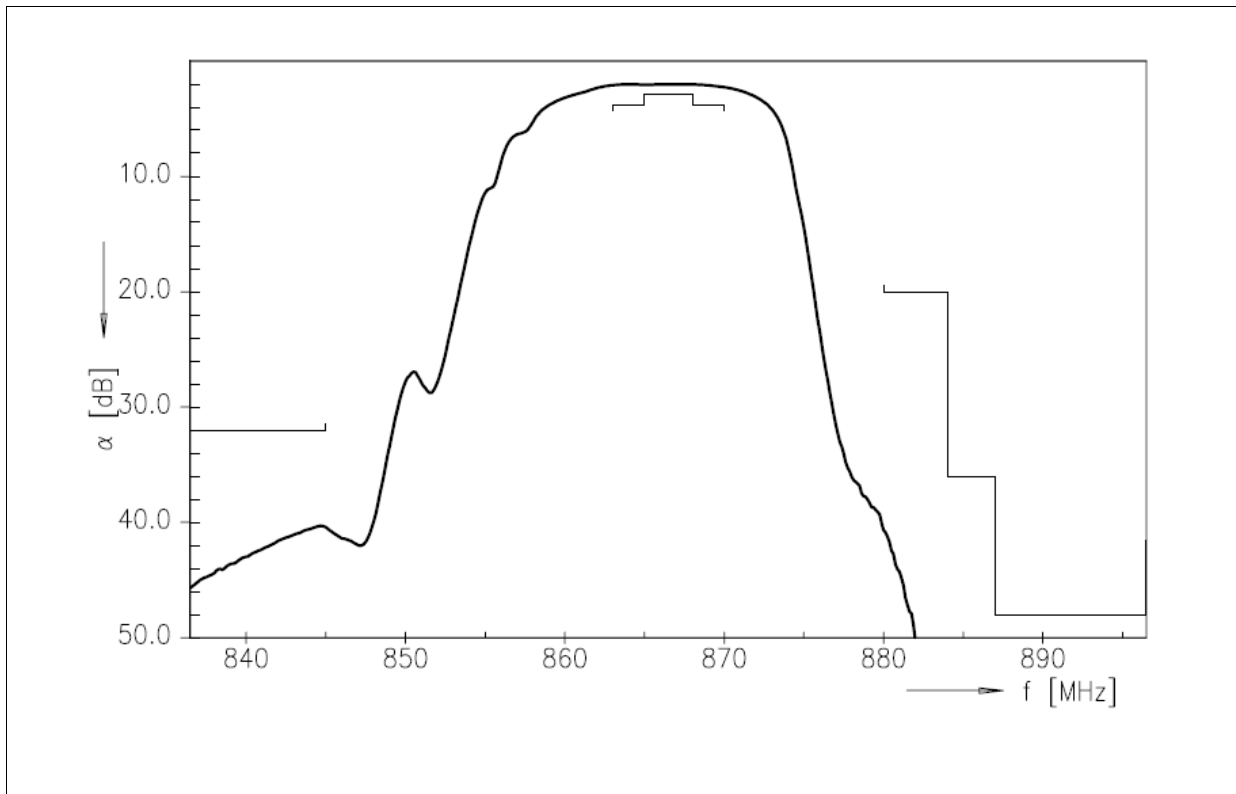

Figure 19: EPCOS B3117 SAW Filter Transfer Function

### 3.14 Hardware Abstraction Layer (HAL)

#### 3.14.1 Introduction

The Semtech SX1301 is an all-digital half-duplex radio modem capable of receiving multiple modulations, multiple radio channels, and multiple data rates simultaneously. This SX1301 is highly configurable. Because of the variable number (and types) of radio channels, modems and transceivers, and because the different hardware implementations can be quite different (typically, not the same register mapping, naming and various features), presenting a unified Hardware Abstraction Layer (HAL) software to the user can greatly simplify writing an application and porting an application between different hardware.

The SX1301 registers are managed by the HAL software. The HAL software can be found on GitHub at the following address:

[https://github.com/Lora-net/lora\\_gateway](https://github.com/Lora-net/lora_gateway)

The hardware supported by the current HAL software is the following:

- SX1301 based board
- Two SX1257 radios
- FPGA (TX mask baseband filter, Background Spectral Scan state machine and SPI muxing) and associated SX1272 radio to execute Background Spectral Scan feature
- A native SPI link between the gateway host and the SX1301 LoRa concentrator

One example of how to use the HAL software is the packet\_forwarder program running on the host of a LoRa gateway. The packet\_forwarder program can be found on GitHub at the following address:

[https://github.com/Lora-net/packet\\_forwarder](https://github.com/Lora-net/packet_forwarder)

### 3.14.2 Abstraction Presented to the Gateway Host

The system composed of a SX1301 and one or more radio transceivers is represented to the user as the following entities:

- 1 or more radio chains,
- 1 or more RX modems with a settable Intermediate Frequency (IF),
- A unified RX packet buffer,
- A single TX chain.

The link between the SX1301 and the gateway host is transparent for the user.

#### **Radio Chain**

A radio chain selects and amplifies a limited portion of the RF spectrum, and digitizes it to be used by the modem chains.

A radio chain is characterized by its bandwidth, maximum and minimum allowed RF frequency in RX, maximum and minimum allowed RF frequency in TX.

#### **Modem Chain**

A modem chain demodulates a small portion (a RF channel) of the RF spectrum digitized by a radio chain. Each modem chain RF channel can be placed individually inside the bandwidth of a radio using the IF (for Intermediate Frequency) setting, that's why they are designated in the abstraction as "IF+modem" chains.

The modem demodulates packets according to its intrinsic capabilities (e.g. the modulations it can process) and user-selected settings (e.g. what is the channel bandwidth for modems that supports multiple bandwidths) and send the receive packets to the RX buffer.

An IF+modem chain is characterized by its type (e.g. Lora "multi", FSK "standard"). That type defines what sort of signal can be demodulated and how the settings are interpreted.

#### **RX Buffer**

Packets that are received by all the modem chains are stored in the RX packet buffer until the gateway host come and fetch them.

#### **TX Chain**

The TX chain is composed of a single multi-standard, multi-bandwidth, multi-data-rate modem and is used to send the single packet waiting in the TX packet buffer through one of the radio chains.



#### 4 External Components

A decoupling capacitor (Cdec) is required to minimize the ripple on the power lines.

Component	Value	Manufacturer	Part number	Package
Cdec	100 nF, 10 V	TDK	C0603X5R1A104KT	0201 (0603 metric)
	100 nF, 6.3 V	Taiyo Yuden	EMK063AC6104MP-F	0201 (0603 metric)
	100 nF, 6.3 V	Murata	GRM033R60J104ME19D	0201 (0603 metric)

**Table 15: Recommended External Components**

**5 PCB Layout Considerations**

The bottom ground paddle must be soldered to a ground plane. The ground plane must be large enough to support SX1301 power dissipation.

The PCB layout must minimize distances between the IC and the decoupling capacitors.

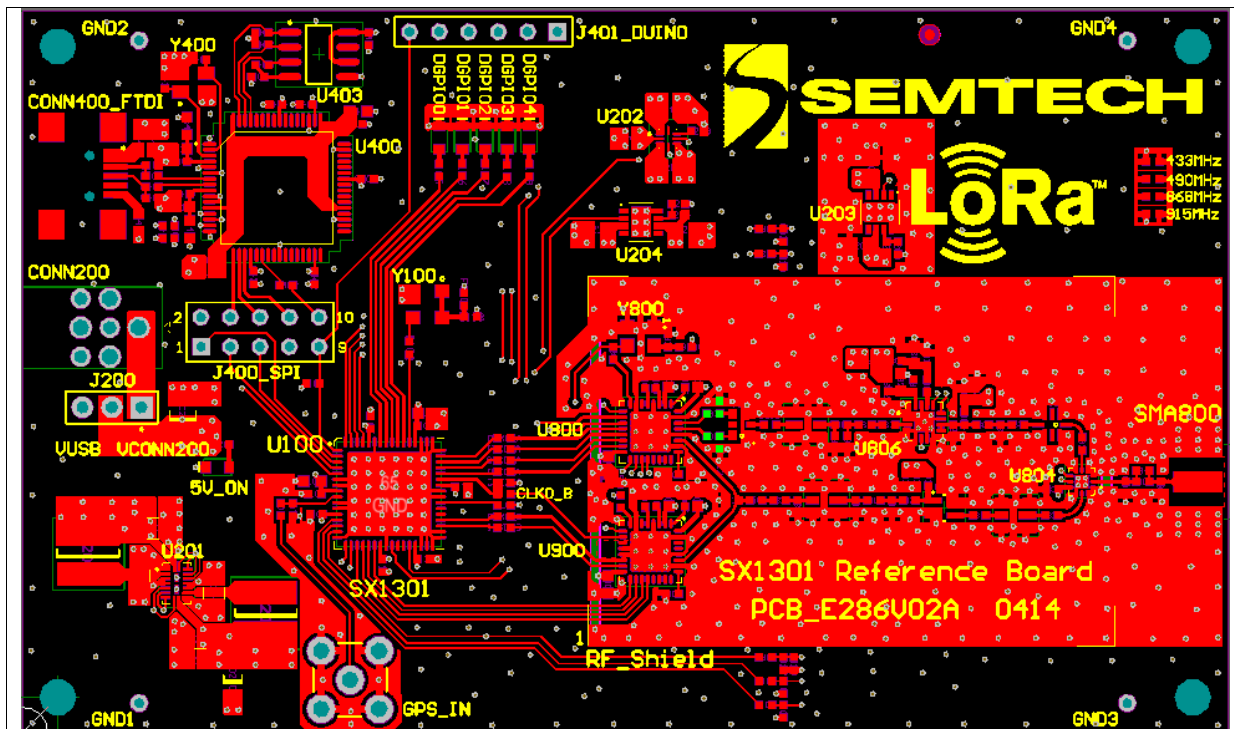

Top layer - signals

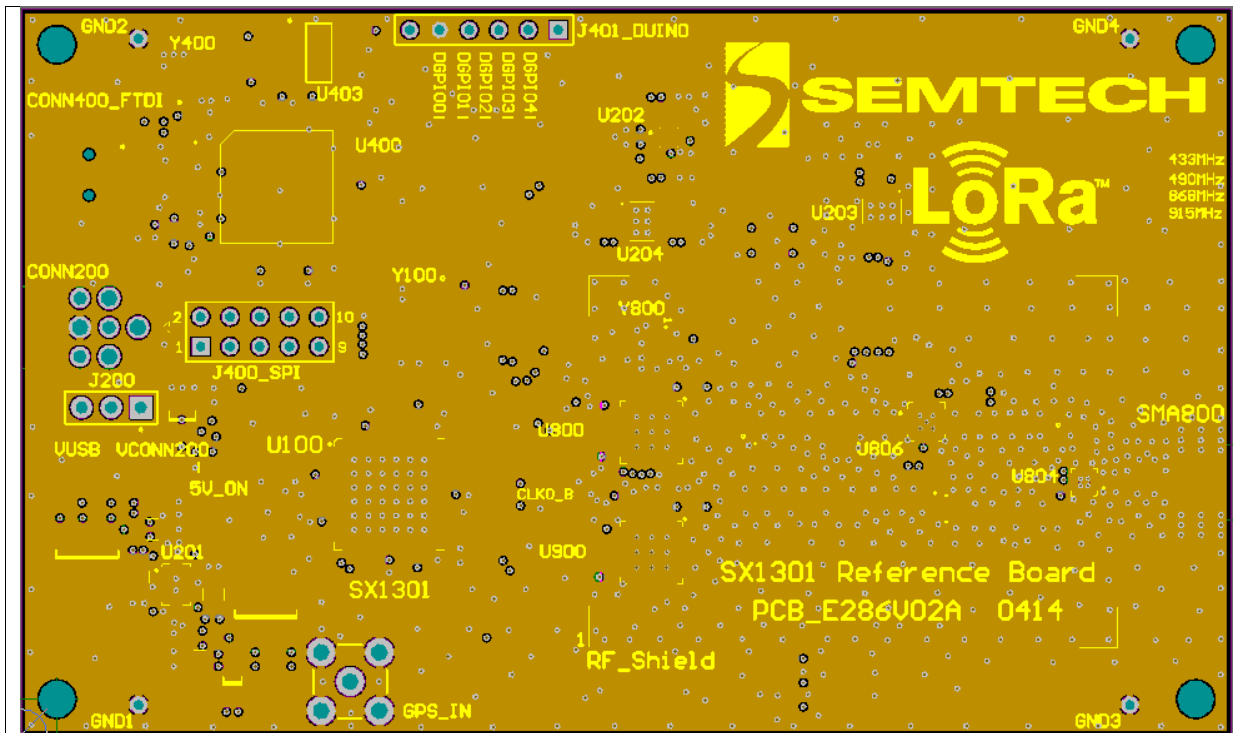

Second layer - shield

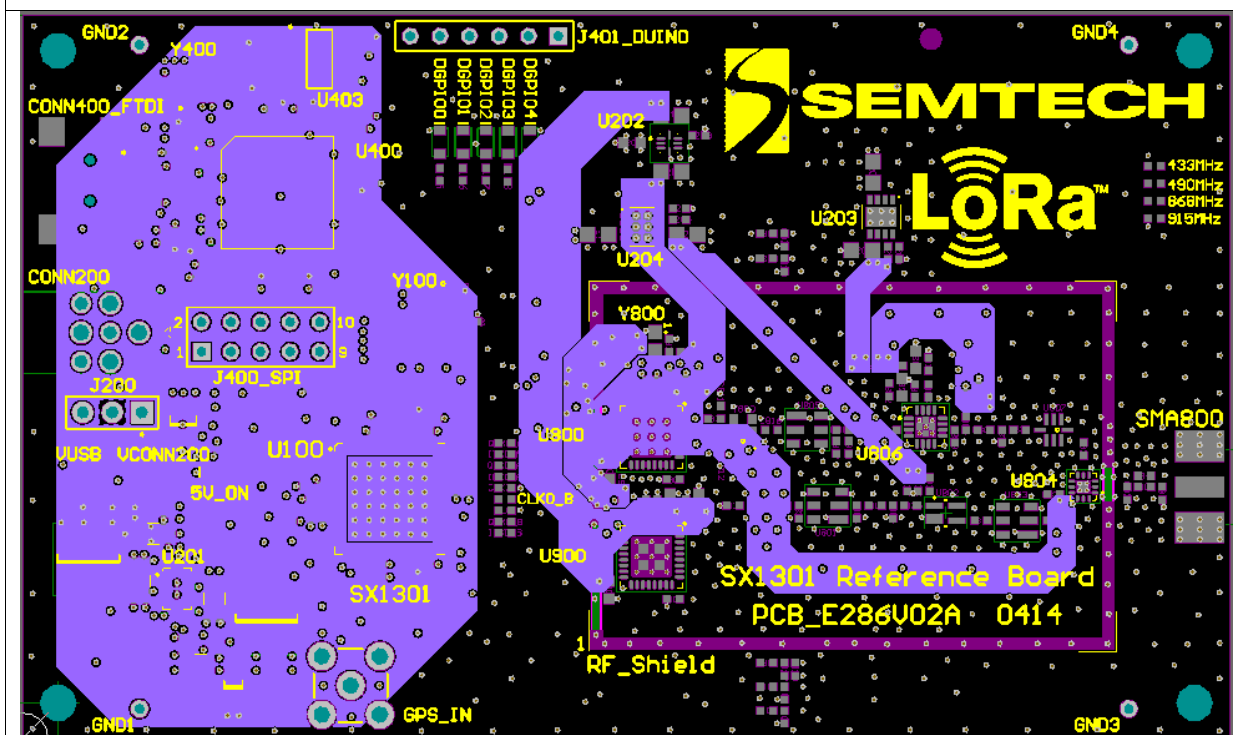

Third layer - power

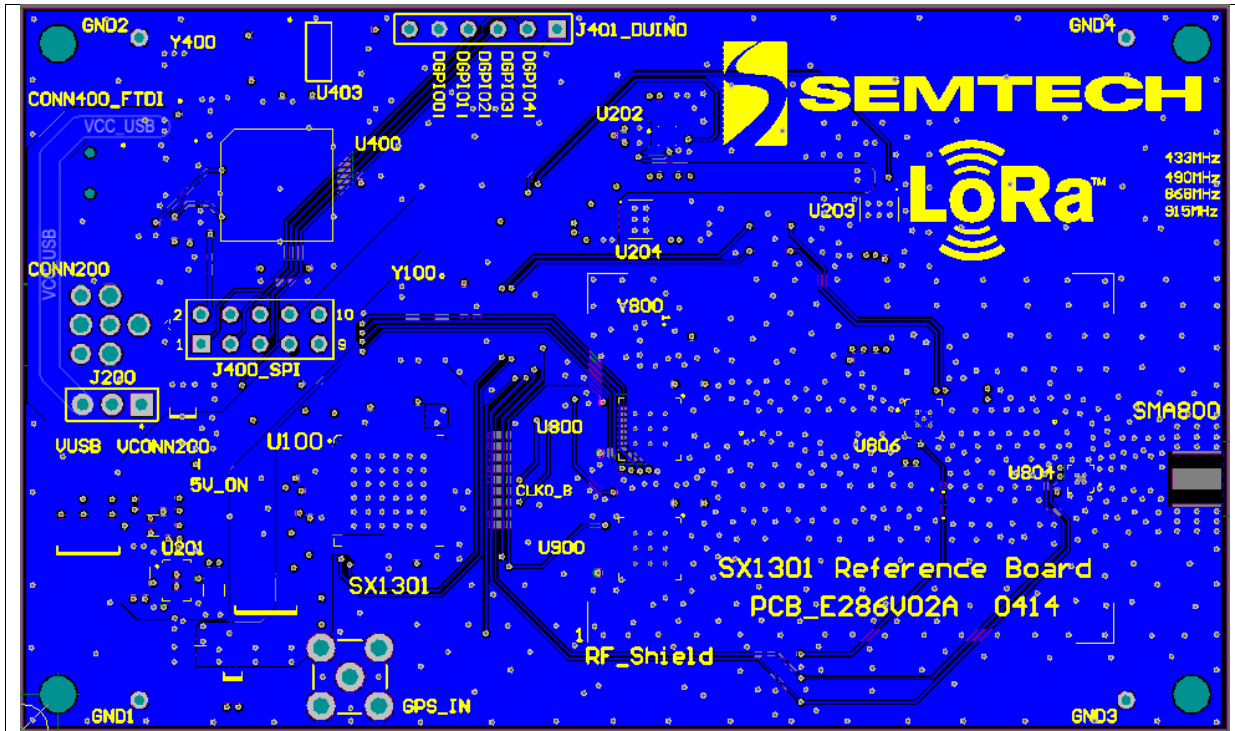

Bottom layer – shield and thermal dissipation

Figure 20: PCB Layout Example

## 6 Packaging Information

### 6.1 Package Outline Drawing

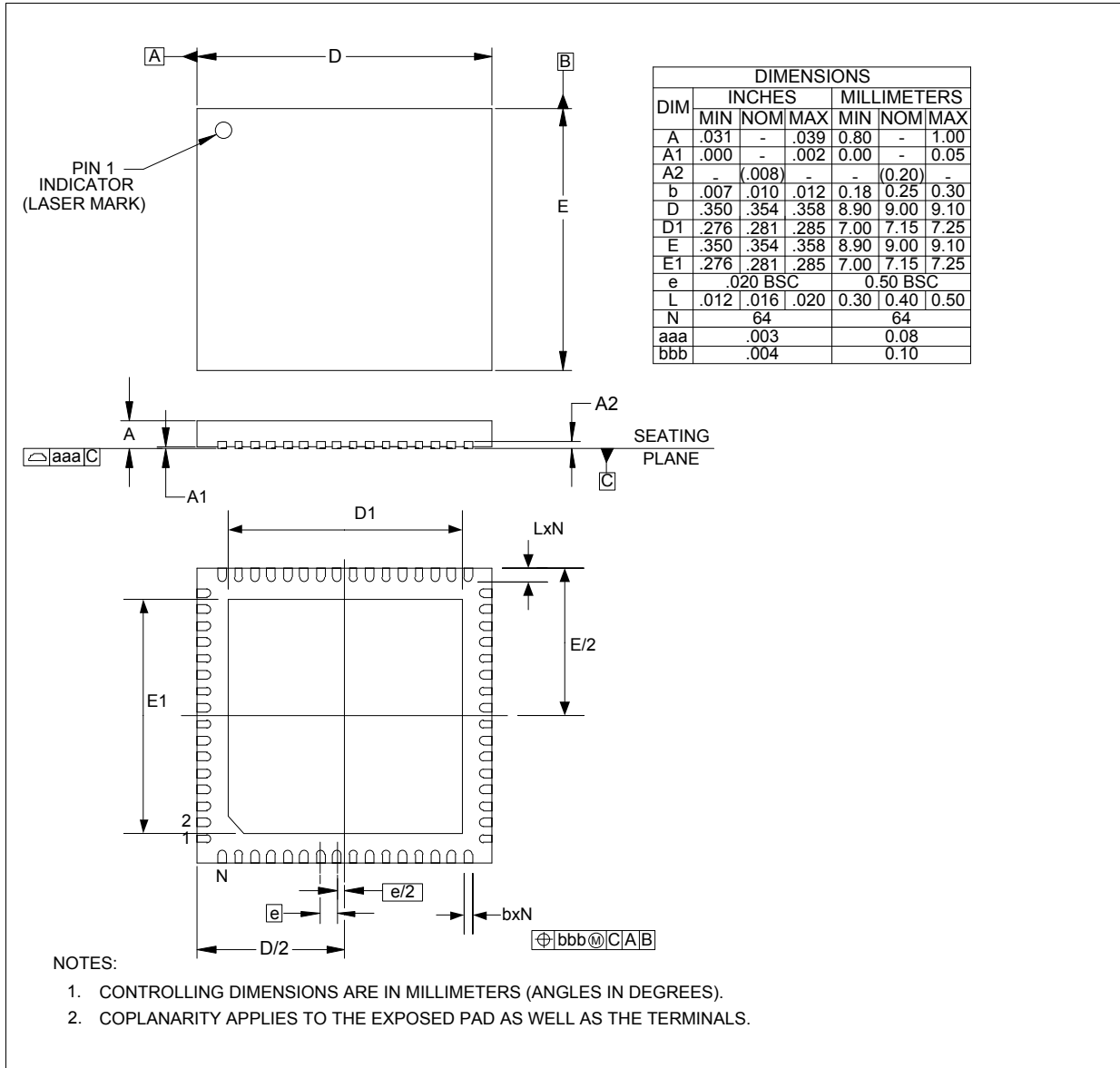
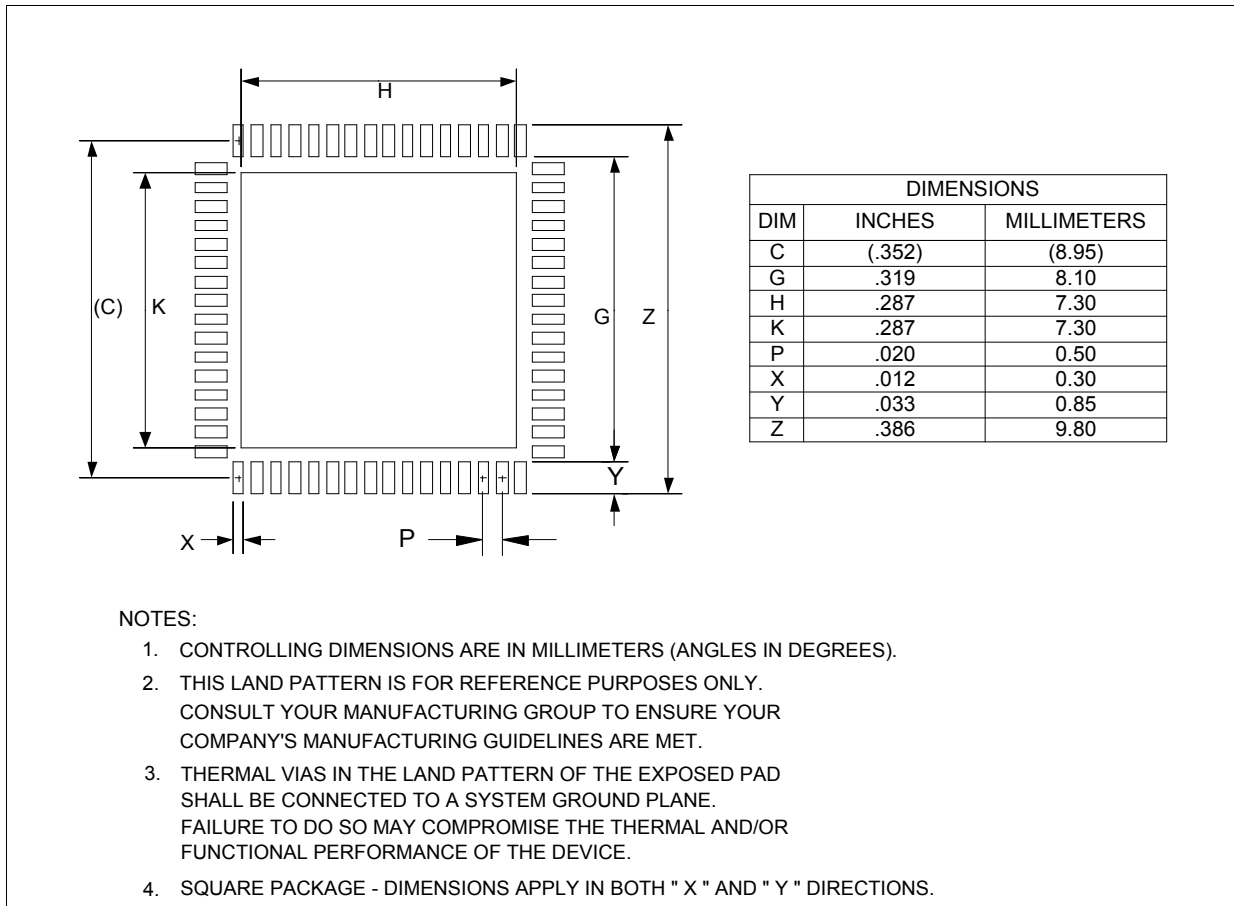

**Figure 21: Package Dimensions**

### 6.2 Thermal Impedance of Package

Thermal impedance with natural convection is 16.4 °C/W. Thermal impedance with heat sink on package bottom is 0.18 °C/W.

The measurement was made with chip paddle soldered to PCB ground plane with minimum 100 cm<sup>2</sup> air exposed area and heat sink per JESD51-7. The package is mounted on a 4-layer (2S2P) standard JEDEC board.

**6.3 Land Pattern Drawing**

**Figure 22: Land Pattern Drawing**

**7 Revision Information**

Revision	Information
V2.4	First release

© Semtech 2017

All rights reserved. Reproduction in whole or in part is prohibited without the prior written consent of the copyright owner. The information presented in this document does not form part of any quotation or contract, is believed to be accurate and reliable and may be changed without notice. No liability will be accepted by the publisher for any consequence of its use. Publication thereof does not convey nor imply any license under patent or other industrial or intellectual property rights. Semtech assumes no responsibility or liability whatsoever for any failure or unexpected operation resulting from misuse, neglect improper installation, repair or improper handling or unusual physical or electrical stress including, but not limited to, exposure to parameters beyond the specified maximum ratings or operation outside the specified range.

SEMTECH PRODUCTS ARE NOT DESIGNED, INTENDED, AUTHORIZED OR WARRANTED TO BE SUITABLE FOR USE IN LIFE-SUPPORT APPLICATIONS, DEVICES OR SYSTEMS OR OTHER CRITICAL APPLICATIONS. INCLUSION OF SEMTECH PRODUCTS IN SUCH APPLICATIONS IS UNDERSTOOD TO BE UNDERTAKEN SOLELY AT THE CUSTOMER'S OWN RISK. Should a customer purchase or use Semtech products for any such unauthorized application, the customer shall indemnify and hold Semtech and its officers, employees, subsidiaries, affiliates, and distributors harmless against all claims, costs damages and attorney fees which could arise.

#### **Contact information**

Semtech Corporation

Wireless & Sensing Products Division

200 Flynn Road, Camarillo, CA 93012

Phone: (805) 498-2111 Fax: (805) 498-3804

[www.semtech.com](http://www.semtech.com)