



Product Description

RFMD's SXA-389 amplifier is a high efficiency GaAs Heterojunction Bipolar Transistor (HBT) MMIC housed in low-cost surface-mountable plastic package. These HBT MMICs are fabricated using molecular beam epitaxial growth technology which produces reliable and consistent performance from wafer to wafer and lot to lot. These amplifiers are specially designed for use as driver devices for infrastructure equipment in the 400MHz to 2500MHz cellular, ISM, WLL, PCS, W-CDMA applications.

Optimum Technology Matching® Applied

- GaAs HBT
- GaAs MESFET
- InGaP HBT
- SiGe BiCMOS
- Si BiCMOS
- SiGe HBT
- GaAs pHEMT
- Si CMOS
- Si BJT
- GaN HEMT
- InP HBT
- RF MEMS
- LDMOS

Typical IP3, P1dB, Gain

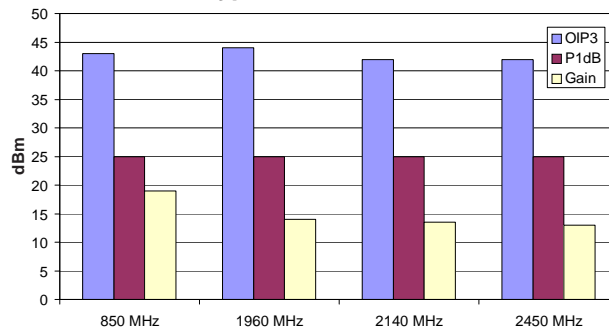

Features

- Available in RFMD Green, RoHS Compliant, and Pb-Free (Z Part Number)
- On-Chip Active Bias Control, Single 5V Supply
- High Output 3rd Order Intercept: +42 to +44 dBm Typ.
- High P_{1dB} : +25 dBm Typ.
- High Gain: +19 dB at 850 MHz
- High Efficiency: Consumes Only 600 mW
- Patented High Reliability GaAs HBT Technology
- Surface-Mountable Power Plastic Package

Applications

- W-CDMA, PCS, Cellular Systems
- High Linearity IF Amplifiers
- Multi-Carrier Applications

Parameter	Specification			Unit	Condition
	Min.	Typ.	Max.		
Small Signal Gain		19.0		dB	850MHz
		14.0		dB	1960MHz
	12.5	13.5	15.0	dB	2140MHz
		13.0		dB	2450MHz
Output Power at 1dB Compression		25.0		dBm	850MHz
		25.0		dBm	1960MHz
	24.0	25.0		dBm	2140MHz
		25.0		dBm	2450MHz
Output Third Order Intercept Point		43.0		dBm	850MHz
		44.0		dBm	1960MHz
	39.0	42.0		dBm	2140MHz
		42.0		dBm	2450MHz
Noise Figure		4.7		dB	850MHz
		5.5		dB	1960MHz
		6.0		dB	2140MHz
		6.0		dB	2450MHz
Input VSWR		1.3:1			850MHz
		1.4:1			1960MHz
		1.3:1			2140MHz
		1.1:1			2450MHz
Device Operating Current	90.0	115.0	122.0	mA	V _{CC} =5V
Operating Dissipated Power		575.0	610.0	mW	
Thermal Resistance		100		°C/W	junction to backside

Test Conditions: Z₀=50Ω, T_A=25°C

RF MICRO DEVICES®, RFMD®, Optimum Technology Matching®, Enabling Wireless Connectivity™, PowerStar®, POLARIS™ TOTAL RADIO™ and UltimateBlue™ are trademarks of RFMD, LLC. BLUETOOTH is a trademark owned by Bluetooth SIG, Inc., U.S.A. and licensed for use by RFMD. All other trade names, trademarks and registered trademarks are the property of their respective owners. ©2006, RF Micro Devices, Inc.

Absolute Maximum Ratings

Parameter	Rating	Unit
Max Device Current (I_D)	240	mA
Max Device Voltage (V_D)	6	V
Max RF Input Power	100	mW
Max Dissipated Power	1500	mW
Max Junction Temperature (T_J)	165	°C
Operating Temperature Range (T_L)	-40 to + 85	°C
Max Storage Temperature	150	°C
ESD	1B	Class
Moisture Sensitivity Level	MSL 2	



Caution! ESD sensitive device.

Exceeding any one or a combination of the Absolute Maximum Rating conditions may cause permanent damage to the device. Extended application of Absolute Maximum Rating conditions to the device may reduce device reliability. Specified typical performance or functional operation of the device under Absolute Maximum Rating conditions is not implied.

RoHS status based on EU Directive 2002/95/EC (at time of this document revision).

The information in this publication is believed to be accurate and reliable. However, no responsibility is assumed by RF Micro Devices, Inc. ("RFMD") for its use, nor for any infringement of patents, or other rights of third parties, resulting from its use. No license is granted by implication or otherwise under any patent or patent rights of RFMD. RFMD reserves the right to change component circuitry, recommended application circuitry and specifications at any time without prior notice.

Operation of this device beyond any one of these limits may cause permanent damage. For reliable continuous operation, the device voltage and current must not exceed the maximum operating values specified in the table on page one.

Bias Conditions should also satisfy the following expression:

$$I_D V_D < (T_J - T_L) / R_{TH, j-l}$$

Recommended Mounting Configuration for Optimum RF and Thermal Performance

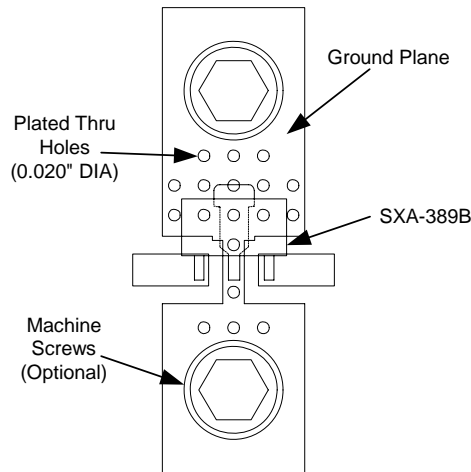

850MHz Application Circuit Data, $V_{CC}=5V$, $I_D=120mA$ (Tuned for Output IP3)

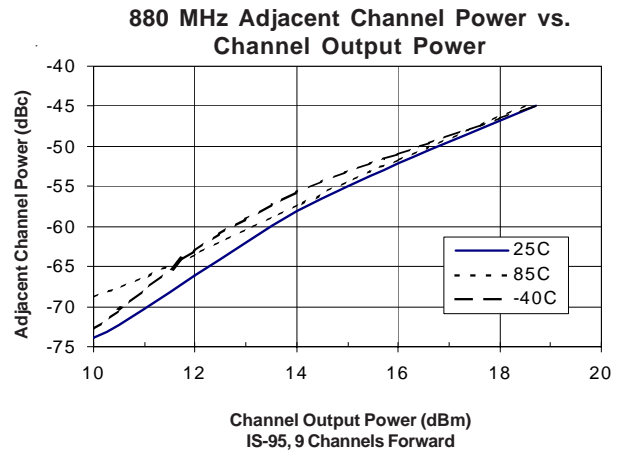
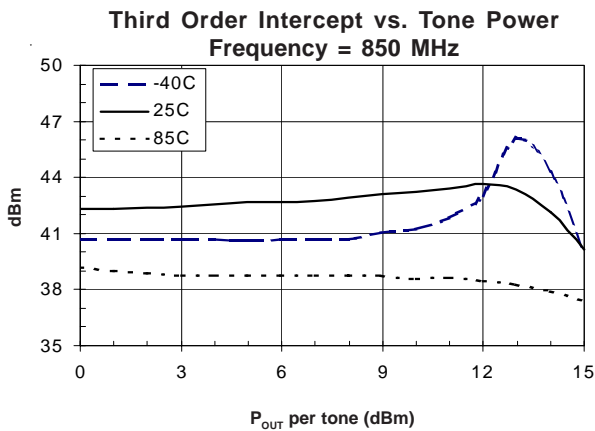
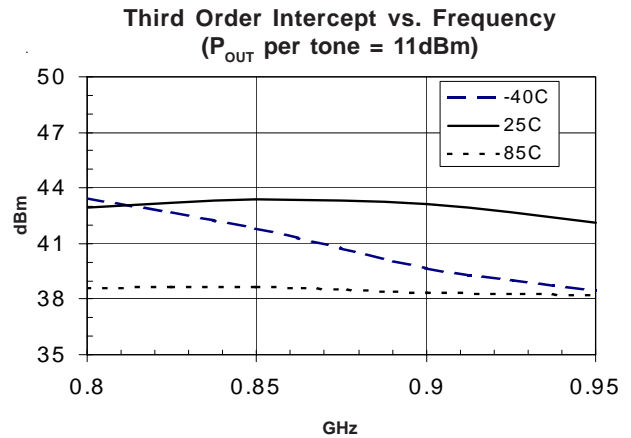
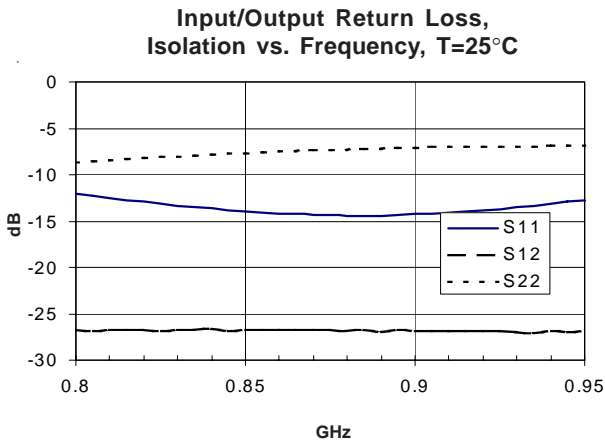
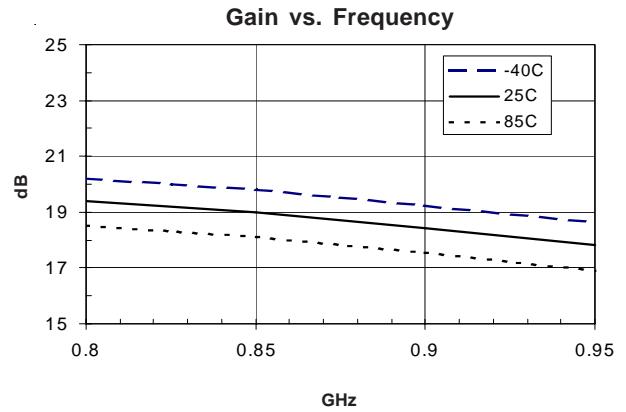
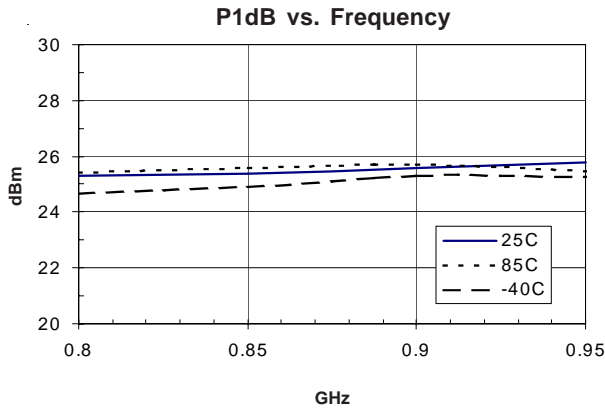

1960MHz Application Circuit Data, $V_{CC}=5V$, $I_D=120mA$ (Tuned for Output IP3)

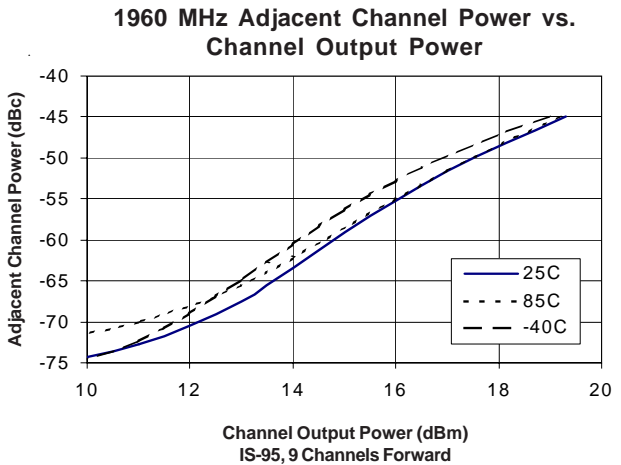
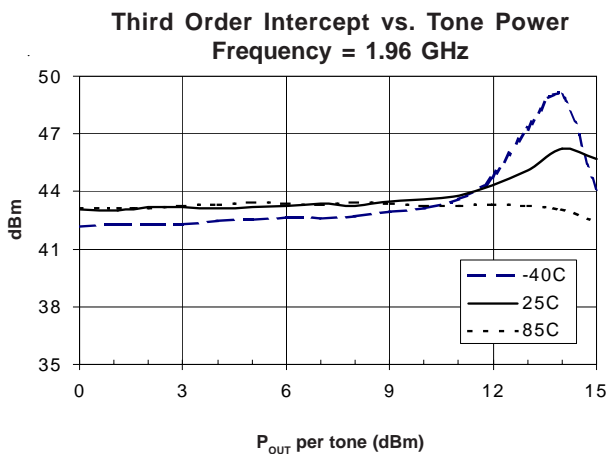
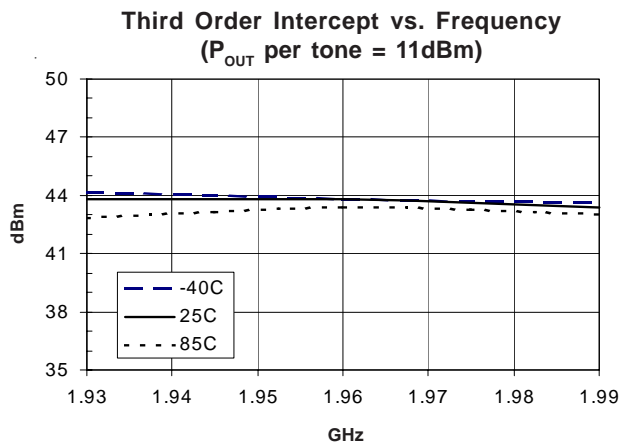
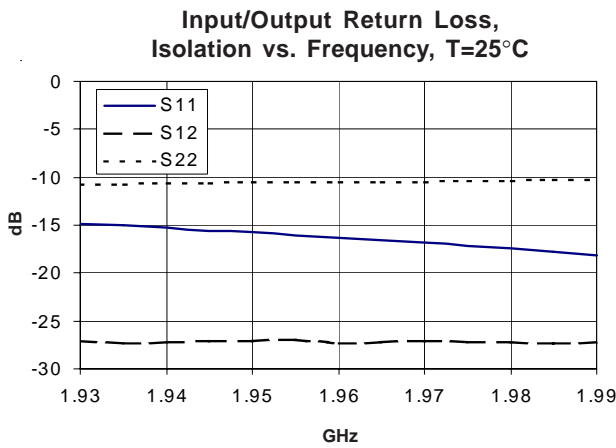
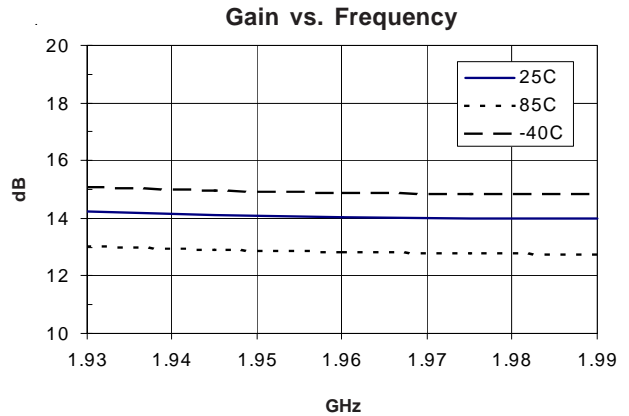
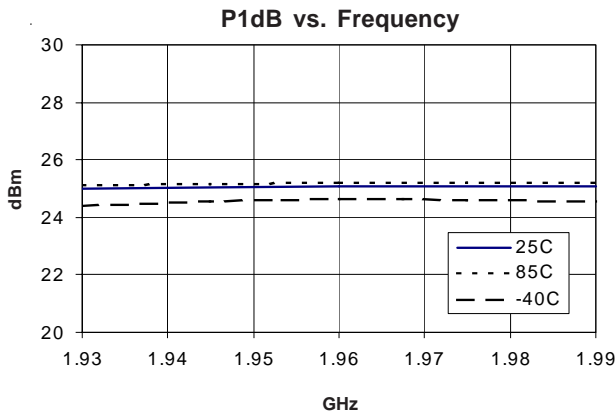

2140MHz Application Circuit Data, $V_{CC}=5V$, $I_D=120mA$ (Tuned for Output IP3)

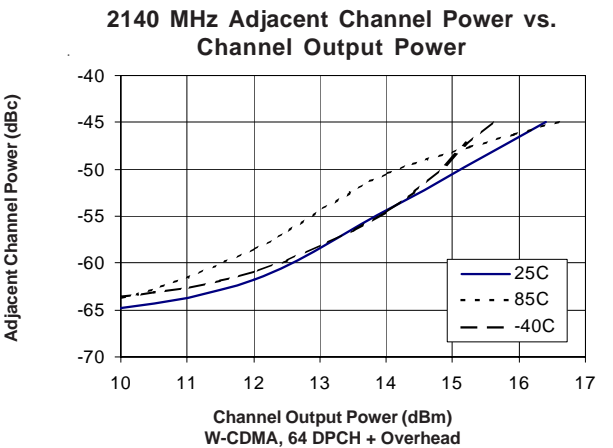
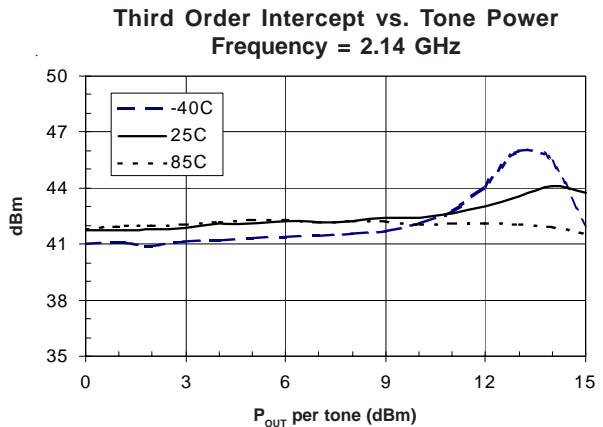
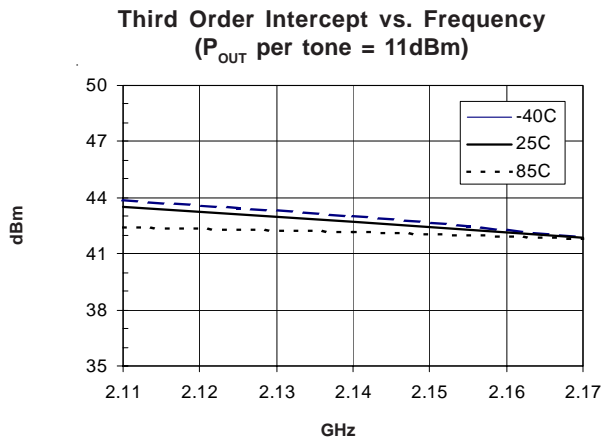
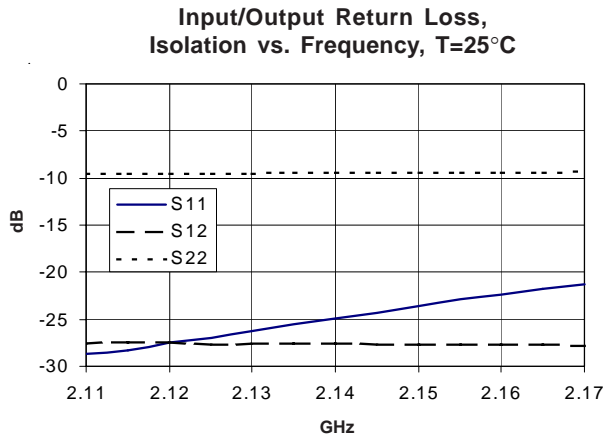
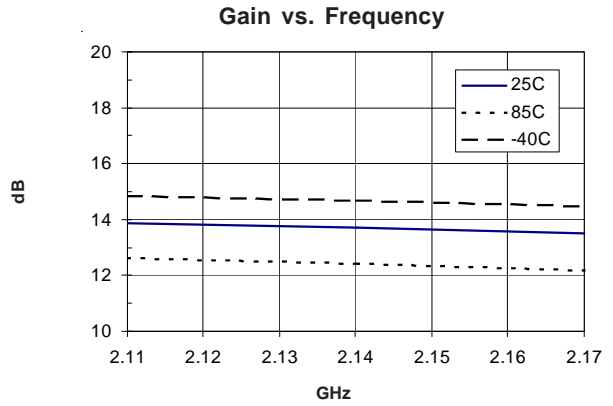
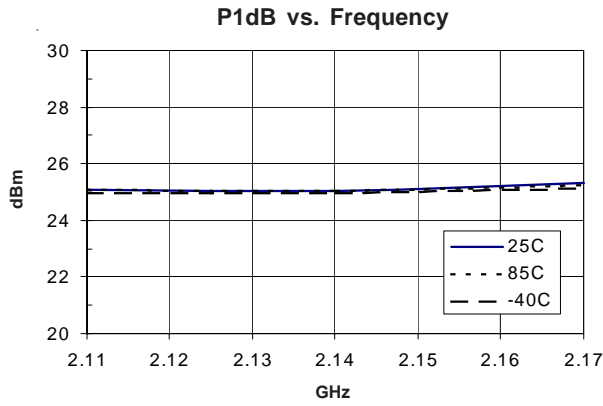

2450MHz Application Circuit Data, $V_{CC}=5V$, $I_D=120mA$ (Tuned for Output IP3)

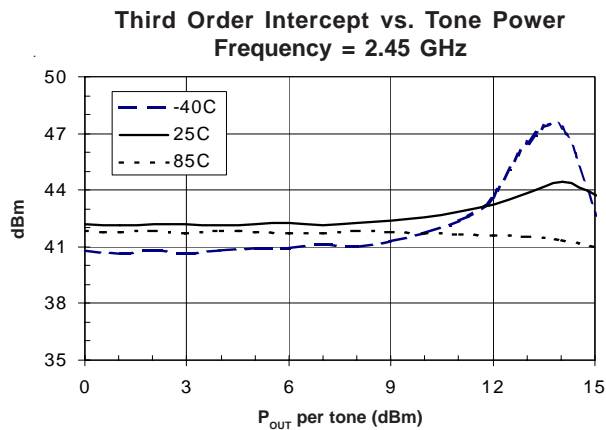
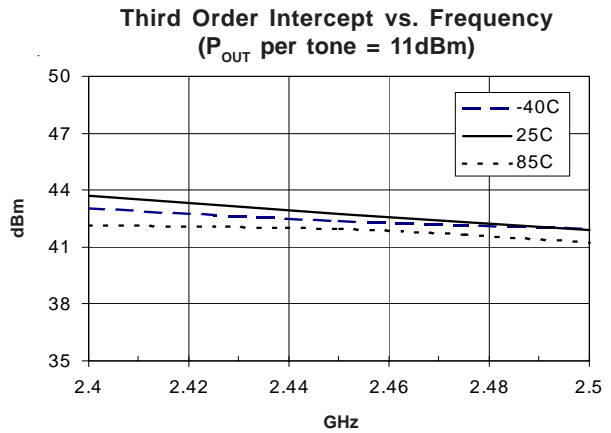
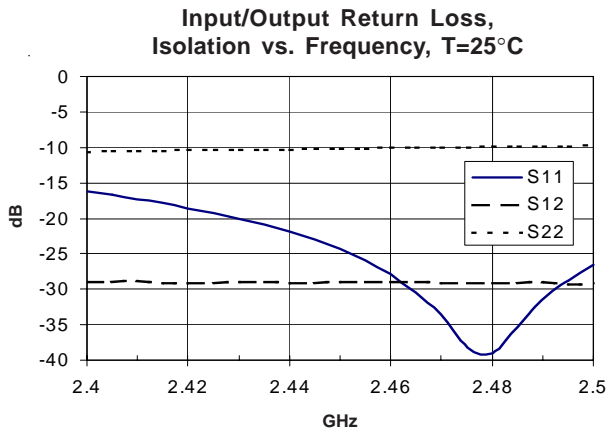
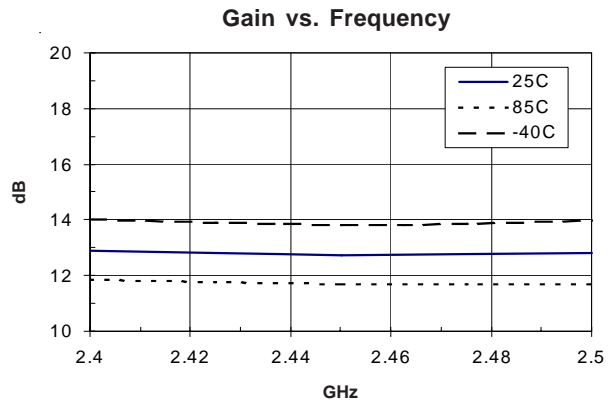
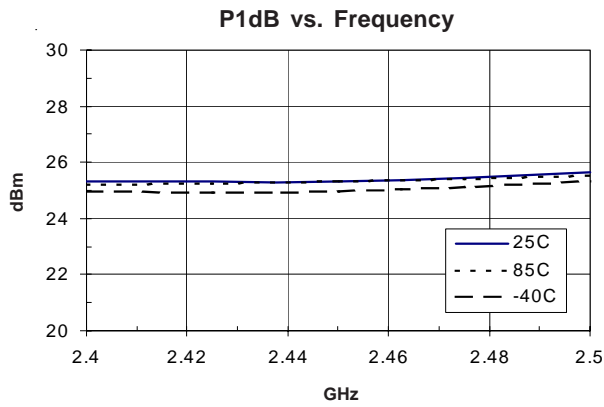

Pin	Function	Description
1	Base	Base Pin
2	GND and Emitter	Connection to ground. Use via holes to reduce lead inductance. Place via holes as close to ground leads as possible.
3	Collector	Collector pin
4	GND and Emitter	Connection to ground. Use via holes to reduce lead inductance. Place via holes as close to ground leads as possible.

Suggested Pad Layout

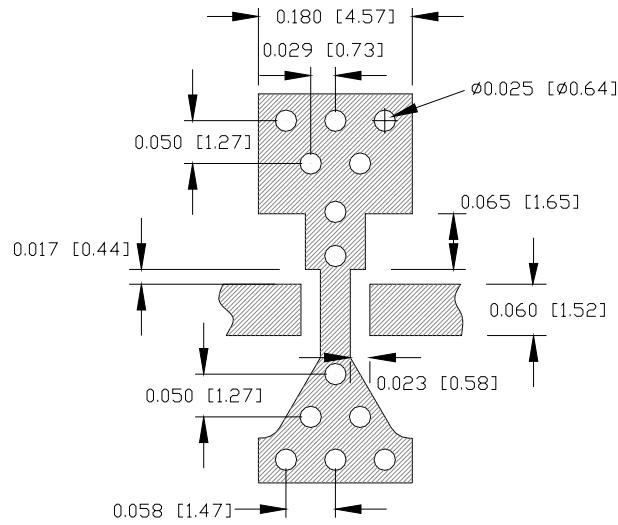

Package Drawing

Dimensions in inches (millimeters)

Refer to drawing posted at www.rfmd.com for tolerances.

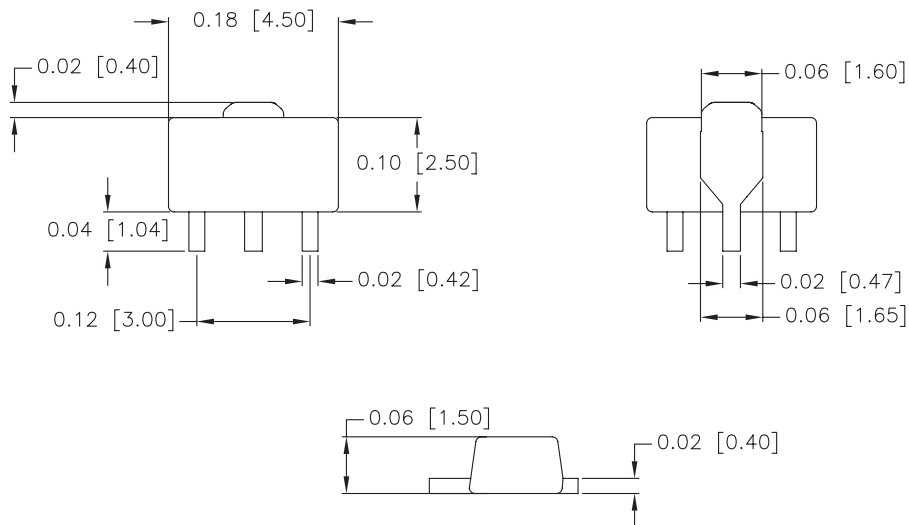

Application Schematic

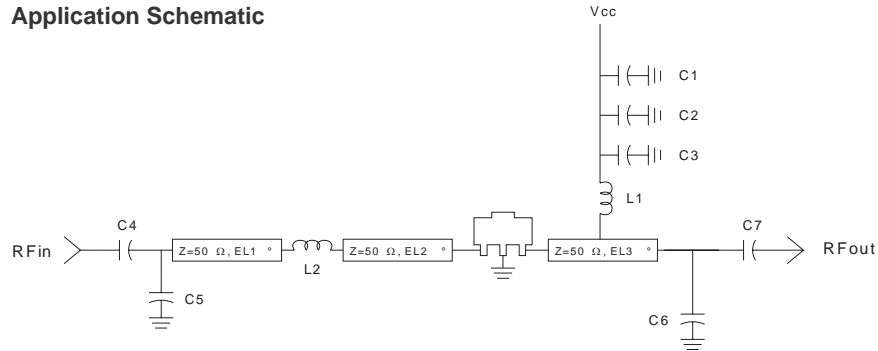

Ref. Des.	Vendor Series	850 MHz	1960 MHz	2140 MHz	2450 MHz
C1	Matsuo 267M3502104K	0.1uF 10%	0.1uF 10%	0.1uF 10%	0.1uF 10%
C2	Rohm MCH18	1000pF 5%	1000pF 5%	1000pF 5%	1000pF 5%
C3, C7	Rohm MCH18	47pF 5%	22pF 5%	22pF 5%	22pF 5%
C4	Rohm MCH18	47pF 5%	22pF 5%	22pF 5%	1.2pF ±0.25pF
C5	Rohm MCH18	3.9pF ±0.25pF	-	-	-
C6	Rohm MCH18	3.9pF ±0.25pF	0.5pF ±0.25pF	0.5pF ±0.25pF	0.5pF ±0.25pF

Ref. Des.	Vendor Series	850 MHz	1960 MHz	2140 MHz	2450 MHz
C6 Position		2	1	1	1
L1	Toko LL1608-FS	33nH 5%	18nH 5%	18nH 5%	15nH 5%
L2	Toko LL1608-FS	1.2nH ±0.3nH	thru	thru	thru
EL1		9.7	-	-	-
EL2		5.6	-	-	-
EL3		13.2	28.7	31.4	35.9

Evaluation Board Layout

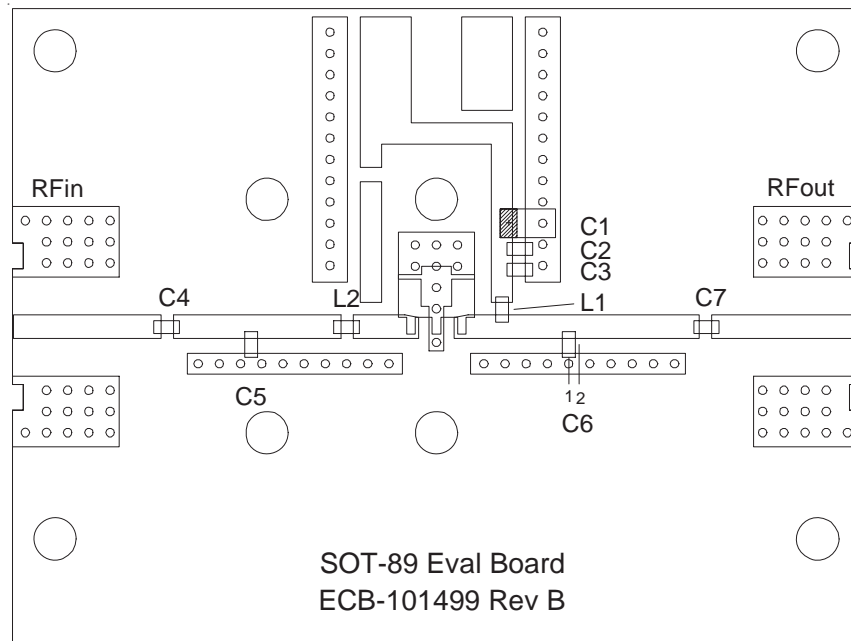

Part Identification

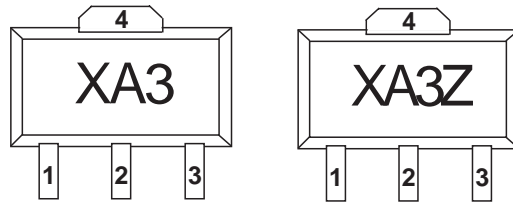

Alternate marking “SXA389Z” or “SXA389” on line one with Trace Code on line 2.

Ordering Information

Part Number	Reel Size	Devices/Reel
SXA-389	7"	1000
SXA-389Z	7"	1000

SXA-389(Z)

