

General Description

The SY8089E1 is a high efficiency 1.5MHz synchronous step down DC/DC regulator, which is capable of delivering up to 2A output current. It can operate over a wide input voltage range from 2.5V to 5.5V and integrate main switch and synchronous switch with very low $R_{DS(ON)}$ to minimize the conduction loss.

The low output voltage ripple, the small external inductor and the capacitor sizes are achieved with 1.5MHz switching frequency.

Ordering Information

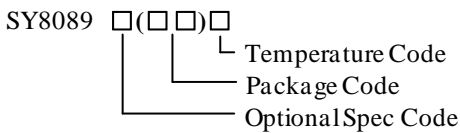

Ordering Number	Package type	Note
SY8089E1AAC	SOT23-5	--

Features

- 2.5V to 5.5V Input Voltage Range
- Low $R_{DS(ON)}$ for Internal Switches (Top/Bottom) 130m Ω /85m Ω
- High Switching Frequency 1.5MHz Minimizes the External Components
- Internal Soft-start Limits the Inrush Current
- Forced PWM Operation
- 100% Dropout Operation
- Hiccup for Short Circuit Protection
- Output Auto Discharge Function
- RoHS Compliant and Halogen Free
- Compact Package: SOT23-5

Applications

- Set Top Box
- USB Dongle
- Media Player
- Smart phone

Typical Applications

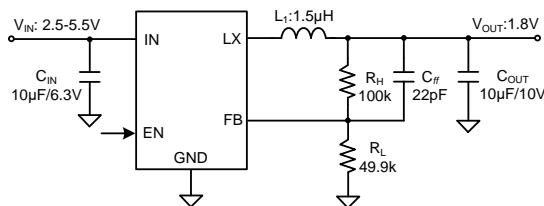

Figure1. Schematic Diagram

Inductor and C_{OUT} Selection Table

V_{OUT} [V]	L [μ H]	C_{OUT} [μ F]			
		4.7	10	22	2x22
1.2/ 1.8 /3.3	1.5		☆	✓	✓
	2.2			✓	✓
	3.3			✓	✓

Note: '☆' means recommended for most applications.

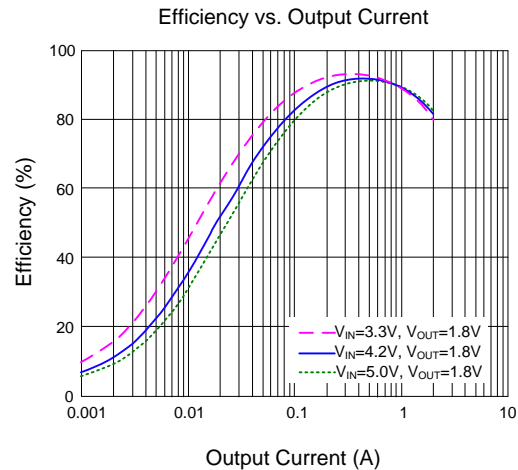
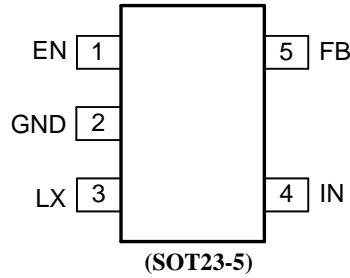

Figure2. Efficiency vs. Output Current

Pinout (Top View)



Top Mark: D9xyz (device code: D9, *x*=year code, *y*=week code, *z*=lot number code)

Pin Name	Pin Number	Pin Description
EN	1	Enable control. Pull high to turn on. Do not leave it floating.
GND	2	Ground pin.
LX	3	Inductor pin. Connect this pin to the switching node of the inductor.
IN	4	Input pin. Decouple this pin to the GND pin with at least a 10μF ceramic capacitor.
FB	5	Output feedback pin. Connect this pin to the center point of the output resistor divider (as shown in Figure 1) to program the output voltage: $V_{OUT}=0.6 \times (1+R_H/R_L)$.

Block Diagram

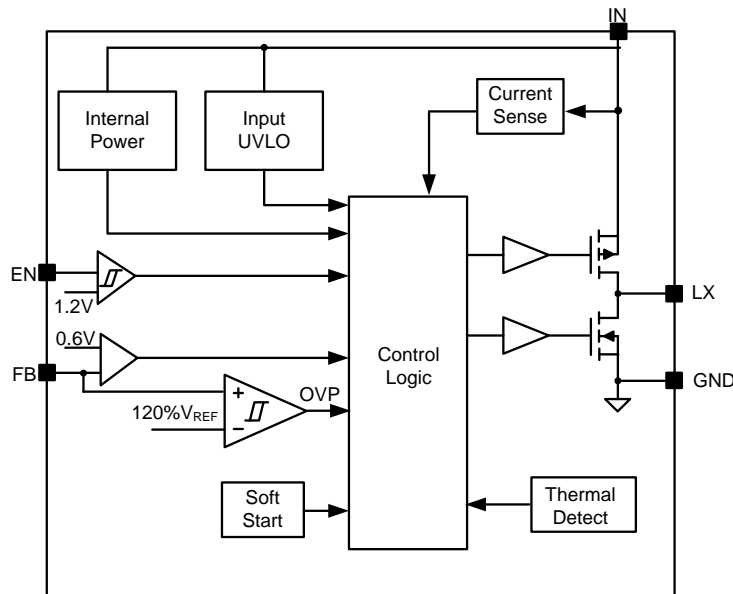

Figure3. Block Diagram



Absolute Maximum Ratings (Note 1)

Supply Input Voltage	-0.3V to 6.0V
FB, EN Voltage	-0.3V to $V_{IN}+0.6V$
LX Voltage	-0.3V ^(*1) to 6.0V ^(*2)
Power Dissipation, P_D @ $T_A = 25^\circ C$	0.83W
Package Thermal Resistance (Note 2)	
θ_{JA}	120°C/W
θ_{JC}	20°C/W
Junction Temperature Range	-40°C to 150°C
Lead Temperature (Soldering, 10 sec.)	260°C
Storage Temperature Range	-65°C to 150°C

(*1) LX Voltage Tested Down to -3V<40ns
(*2) LX Voltage Tested Up to +7V<40ns

Recommended Operating Conditions (Note 3)

Supply Input Voltage	2.5V to 5.5V
Junction Temperature Range	-40°C to 125°C
Ambient Temperature Range	-40°C to 85°C



Electrical Characteristics

($V_{IN} = 5V$, $V_{OUT} = 1.8V$, $L = 1.5\mu H$, $C_{OUT} = 10\mu F$, $T_A = 25^\circ C$, unless otherwise specified)

Parameter	Symbol	Test Conditions	Min	Typ	Max	Unit
Input Voltage Range	V_{IN}		2.5		5.5	V
Input UVLO Threshold	V_{UVLO}				2.5	V
Input UVLO Hysteresis	V_{HYS}			150		mV
Shutdown Current	I_{SHDN}	$V_{EN}=0V$		0.1	1	μA
Feedback Reference Voltage	V_{REF}		591	600	609	mV
LX Node Discharge Resistance	R_{DIS}			50		Ω
Top FET R_{ON}	$R_{DS(ON)1}$			130		m Ω
Bottom FET R_{ON}	$R_{DS(ON)2}$			85		m Ω
EN Input Voltage High	$V_{EN,H}$		1.2			V
EN Input Voltage Low	$V_{EN,L}$				0.4	V
Min ON Time	$t_{ON,MIN}$			60		ns
Maximum Duty Cycle	D_{MAX}		100			%
Turn On Delay	$t_{ON,DLY}$	from EN high to LX start switching		0.5		ms
Soft-start Time	t_{SS}	V_{OUT} from 0% to 100%		1		ms
Switching Frequency	f_{SW}			1.5		MHz
Top FET Current Limit	$I_{LMT, TOP}$		3.5			A
Thermal Shutdown Temperature	T_{SD}			160		$^\circ C$
Thermal Shutdown Hysteresis	T_{HYS}			20		$^\circ C$

Note 1: Stresses beyond the “Absolute Maximum Ratings” may cause permanent damage to the device. These are stress ratings only. Functional operation of the device at these or any other conditions beyond those indicated in the operational sections of the specification is not implied. Exposure to absolute maximum rating conditions for extended periods may affect device reliability.

Note 2: θ_{JA} of SY8089E1 is measured in the natural convection at $T_A = 25^\circ C$ on a 2OZ two-layer Silergy evaluation board. Pin 3 is the case position for θ_{JC} measurement.

Note 3: The device is not guaranteed to function outside its operating conditions.

SOT23-5 Package Outline & PCB layout

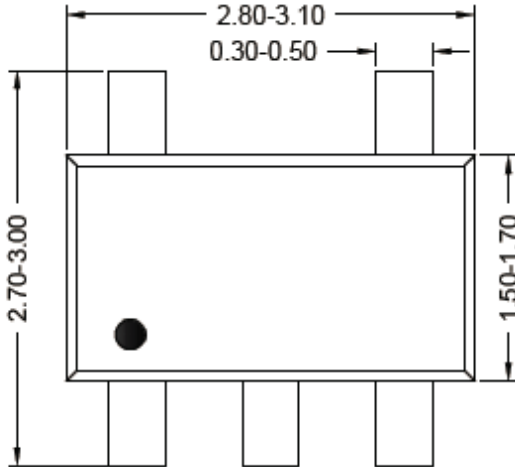

Top view

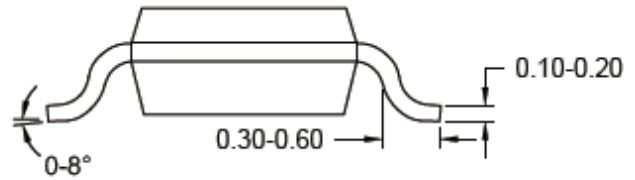

Side view

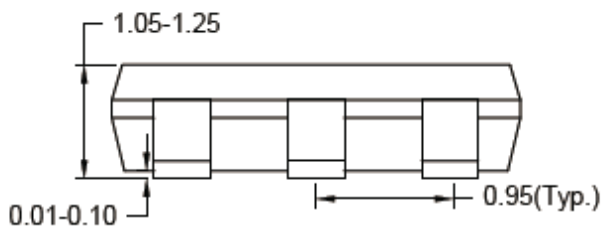

Front view

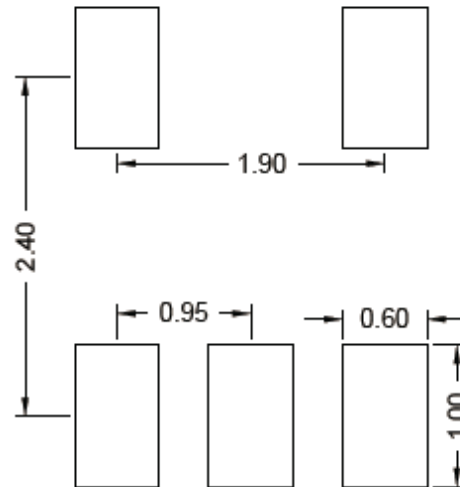

Recommended Pad Layout

Notes: All dimension in millimeter and exclude mold flash & metal burr.

Taping & Reel Specification

1. Taping orientation

SOT23-5

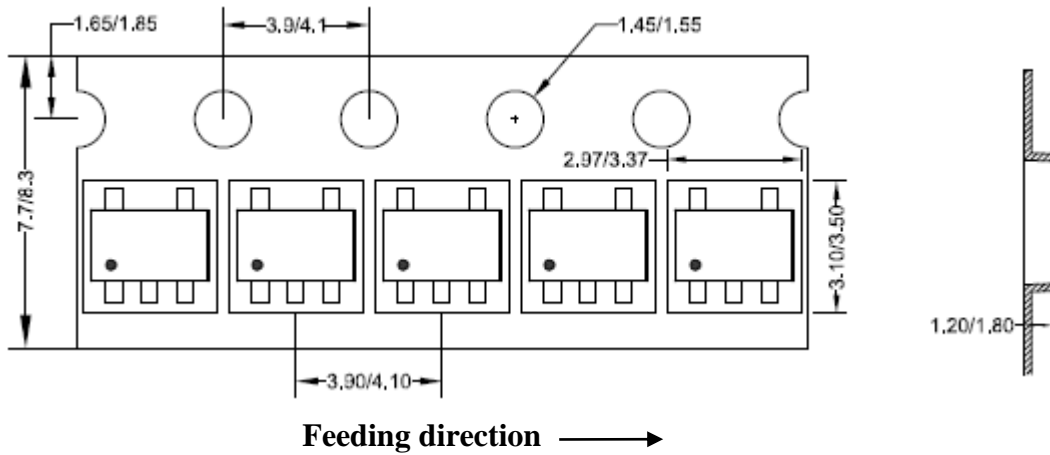

2. Carrier Tape & Reel specification for packages

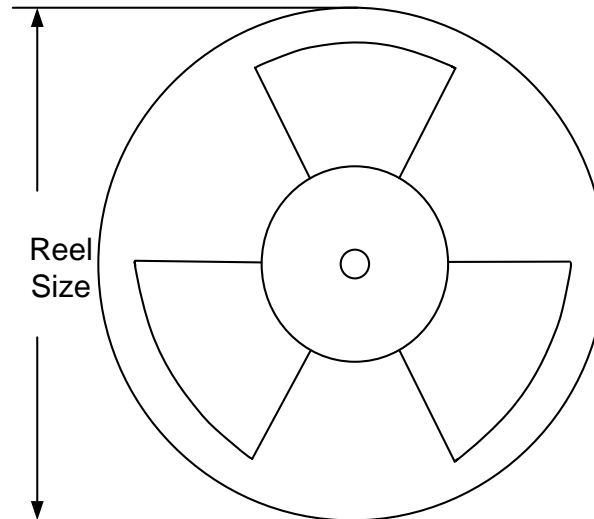

Package type	Tape width (mm)	Pocket pitch(mm)	Reel size (Inch)	Trailer length(mm)	Leader length (mm)	Qty per reel
SOT23-5	8	4	7"	280	160	3000

3. Others: NA