

# SZ1.5SMC Series

## Surface Mount > 1500W



### Additional Information



Resources



Accessories



Samples

### Agency Approvals

Agency	Agency File Number
	E128662

### Maximum Ratings and Thermal Characteristics

Parameter	Symbol	Value	Unit
Peak Power Dissipation (Note 1) @ $T_L = 25^\circ\text{C}$ , Pulse Width = 1 ms	$P_{PK}$	1500	W
DC Power Dissipation @ $T_L = 75^\circ\text{C}$ Measured Zero Lead Length (Note 2)	$P_D$	4.0	W
Derate Above $75^\circ\text{C}$		54.6	mW/ $^\circ\text{C}$
Thermal Resistance from Junction-to-Lead	$R_{\theta JL}$	18.3	$^\circ\text{C}/\text{W}$
DC Power Dissipation (Note 3) @ $T_A = 25^\circ\text{C}$	$P_D$	0.75	W
Derate Above $25^\circ\text{C}$		6.1	mW/ $^\circ\text{C}$
Thermal Resistance from Junction-to-Ambient	$R_{\theta JA}$	75	$^\circ\text{C}/\text{W}$
Forward Surge Current (Note 4) @ $T_A = 25^\circ\text{C}$	$I_{FSM}$	200	A
Operating and Storage Temperature Range	$T_J, T_{stg}$	-65 to +150	$^\circ\text{C}$

Stresses exceeding Maximum Ratings may damage the device. Maximum Ratings are stress ratings only. Functional operation above the Recommended Operating Conditions is not implied. Extended exposure to stresses above the Recommended Operating Conditions may affect device reliability.

- 10 x 1000  $\mu\text{s}$ , non-repetitive.
- 1 in square copper pad, FR-4 board.
- FR-4 board, using Littelfuse minimum recommended footprint, as shown in 403-03 case outline dimensions spec.
- 1/2 sine wave (or equivalent square wave),  $P_{av} = 8.3$  ms, duty cycle = 4 pulses per minute maximum.

### Description

The SZ1.5SMC series is designed to protect voltage sensitive components from high voltage, high energy transients. They have excellent clamping capability, high surge capability, low zener impedance and fast response time. The SZ1.5SMC series is supplied in the exclusive, cost-effective, highly reliable Littelfuse package and is ideally suited for use in communication systems, automotive, numerical controls, process controls, medical equipment, business machines, power supplies and many other industrial/consumer applications.

### Features & Benefits

- Zener Transient Overvoltage Suppressors
- Working Peak Reverse Voltage Range – 5.8 V to 77.8 V
- Standard Zener Breakdown Voltage Range – 6.45 V to 95.5 V
- Peak Power – 1500 W @ 1 ms
- ESD protection of data lines in accordance with IEC 61000-4-2 30kV(Air), 30kV (Contact)
- ESD Rating of Class 3 (> 16 KV) per Human Body Model
- Maximum Clamp Voltage @ Peak Pulse Current
- Low Leakage < 5  $\mu\text{A}$  Above 10 V
- $V_{BR} @ T_J = V_{BR} @ 25^\circ\text{C} \times (1 + \alpha T \times (T_J - 25))$  ( $\alpha$ : Temperature Coefficient)
- Recognized to UL 497B as an Isolated Loop Circuit Protector
- Maximum Temperature Coefficient Specified
- Response Time is Typically < 1 ns
- Pb-Free Packages are Available
- SZ Prefix for Automotive and Other Applications Requiring Unique Site and Control Change Requirements; AEC-Q101 Qualified and PPAP Capable

### Functional Diagram

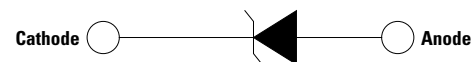

# SZ1.5SMC Series

## Surface Mount > 1500W

**I-V Curve Characteristics** ( $T_A = 25^\circ\text{C}$  unless otherwise noted,  $V_F = 3.5\text{ V Max @ } I_F = 100\text{ A}$ ) (Note 5)

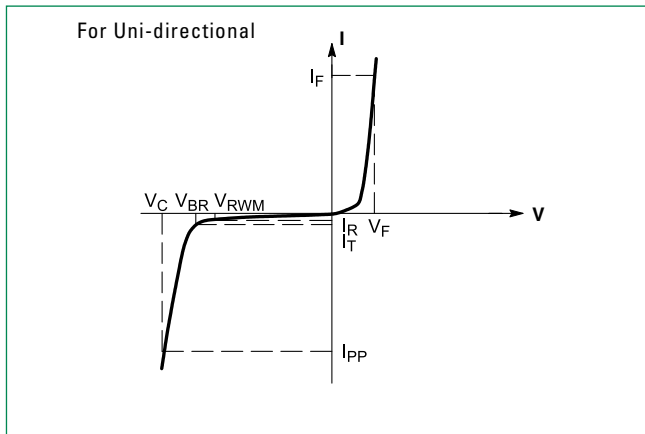

Symbol	Parameter
$I_{PP}$	Maximum Reverse Peak Pulse Current
$V_C$	Clamping Voltage @ $I_{PP}$
$V_{RWM}$	Working Peak Reverse Voltage
$I_R$	Maximum Reverse Leakage Current @ $V_{RWM}$
$V_{BR}$	Breakdown Voltage @ $I_T$
$I_T$	Test Current
$I_F$	Forward Current
$V_F$	Forward Voltage @ $I_F$

**Note 5:** 1/2 sine wave (or equivalent square wave), PW = 8.3 ms, non-repetitive duty cycle.

**Electrical Characteristics** ( $T_A = 25^\circ\text{C}$  unless otherwise noted)

Device	Device Marking	$V_{RWM}$ (Note 6)	$I_R$ @ $V_{RWM}$	Breakdown Voltage				$V_C$ @ $I_{PP}$ (Note 8)		MV BR TYP.
				$V_{BR}$ (V) (Note 7)			@ $I_T$	$V_C$	$I_{PP}$	
				Min	Nom	Max	mA	Volts	Amps	
SZ1.5SMC6.8AT3G	6V8A	5.8	1000	6.45	6.8	7.14	10	10.5	143	0.057
SZ1.5SMC7.5AT3G	7V5A	6.4	500	7.13	7.5	7.88	10	11.3	132	0.061
SZ1.5SMC10AT3G	10A	8.55	10	9.5	10	10.5	1	14.5	103	0.073
SZ1.5SMC12AT3G	12A	10.2	5	11.4	12	12.6	1	16.7	90	0.078
SZ1.5SMC13AT3G	13A	11.1	5	12.4	13	13.7	1	18.2	82	0.081
SZ1.5SMC15AT3G	15A	12.8	5	14.3	15	15.8	1	21.2	71	0.084
SZ1.5SMC16AT3G	16A	13.6	5	15.2	16	16.8	1	22.5	67	0.086
SZ1.5SMC18AT3G	18A	15.3	5	17.1	18	18.9	1	25.2	59.5	0.088
SZ1.5SMC20AT3G	20A	17.1	5	19	20	21	1	27.7	54	0.09
SZ1.5SMC22AT3G	22A	18.8	5	20.9	22	23.1	1	30.6	49	0.092
SZ1.5SMC24AT3G	24A	20.5	5	22.8	24	25.2	1	33.2	45	0.094
SZ1.5SMC27AT3G	27A	23.1	5	25.7	27	28.4	1	37.5	40	0.096
SZ1.5SMC30AT3G	30A	25.6	5	28.5	30	31.5	1	41.4	36	0.097
SZ1.5SMC33AT3G	33A	28.2	5	31.4	33	34.7	1	45.7	33	0.098
SZ1.5SMC36AT3G	36A	30.8	5	34.2	36	37.8	1	49.9	30	0.099
SZ1.5SMC39AT3G	39A	33.3	5	37.1	39	41	1	53.9	28	0.1
SZ1.5SMC43AT3G	43A	36.8	5	40.9	43	45.2	1	59.3	25.3	0.101
SZ1.5SMC47AT3G	47A	40.2	5	44.7	47	49.4	1	64.8	23.2	0.101
SZ1.5SMC51AT3G	51A	43.6	5	48.5	51	53.6	1	70.1	21.4	0.102
SZ1.5SMC56AT3G	56A	47.8	5	53.2	56	58.8	1	77	19.5	0.103
SZ1.5SMC62AT3G	62A	53	5	58.9	62	65.1	1	85	17.7	0.104
SZ1.5SMC68AT3G	68A	58.1	5	64.6	68	71.4	1	92	16.3	0.104
SZ1.5SMC75AT3G	75A	64.1	5	71.3	75	78.8	1	103	14.6	0.105
SZ1.5SMC82AT3G	82A	70.1	5	77.9	82	86.1	1	113	13.3	0.105
SZ1.5SMC91AT3G	91A	77.8	5	86.5	91	95.5	1	125	12	0.106

**Notes:**

6. A transient suppressor is normally selected according to the maximum working peak reverse voltage ( $V_{RWM}$ ), which should be equal to or greater than the DC or continuous peak operating voltage level.

7.  $V_{BR}$  measured at pulse test current  $I_T$  at an ambient temperature of  $25^\circ\text{C}$ .

8. Surge current waveform per Figure 2 and derate per Figure 3 of the General Data - 1500 Watt at the beginning of this group.

# SZ1.5SMC Series

Surface Mount > 1500W

## Ratings and Characteristic Curves

**Figure 1. Pulse Rating Curve**

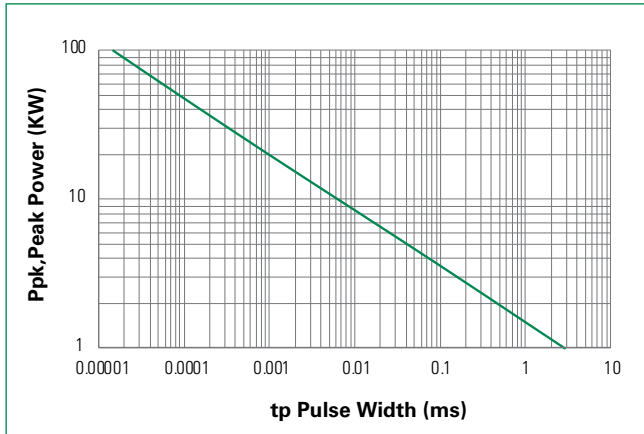

**Figure 2. Pulse Waveform**

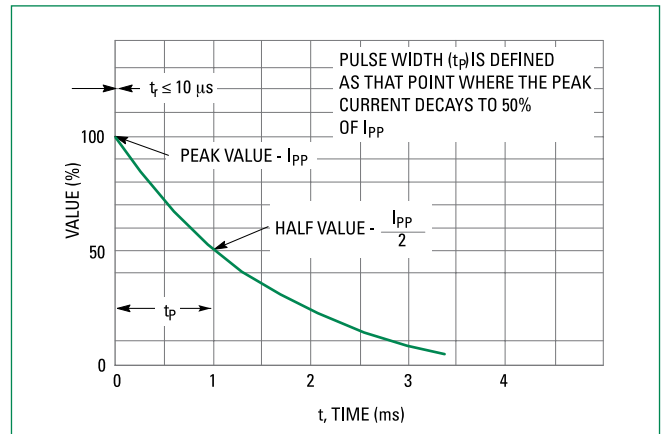

**Figure 3. Surge Derating Curve**

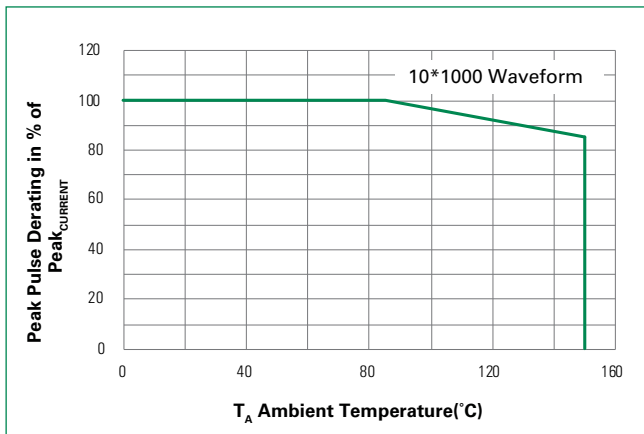

**Figure 4. Typical Junction Capacitance vs. Bias Voltage**

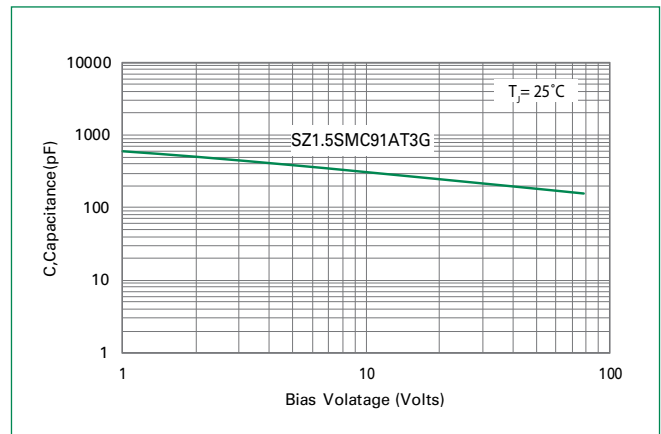

# SZ1.5SMC Series

## Surface Mount > 1500W

### Soldering Parameters

<b>Reflow Condition</b>		Lead-free assembly
<b>Pre Heat</b>	- Temperature Min ( $T_{s(min)}$ )	150°C
	- Temperature Max ( $T_{s(max)}$ )	200°C
	- Time (min to max) ( $t_s$ )	60 – 120 secs
<b>Average ramp up rate (Liquidus Temp (<math>T_L</math>) to peak)</b>		3°C/second max
<b><math>T_{s(max)}</math> to <math>T_L</math> - Ramp-up Rate</b>		3°C/second max
<b>Reflow</b>	- Temperature ( $T_L$ ) (Liquidus)	217°C
	- Time (min to max) ( $t_L$ )	60 – 150 seconds
<b>Peak Temperature (<math>T_p</math>)</b>		260 <sup>+0/-5</sup> °C
<b>Time within 5°C of actual peak Temperature (<math>t_p</math>)</b>		30 seconds max
<b>Ramp-down Rate</b>		6°C/second max
<b>Time 25°C to peak Temperature (<math>T_p</math>)</b>		8 minutes max.
<b>Do not exceed</b>		260°C

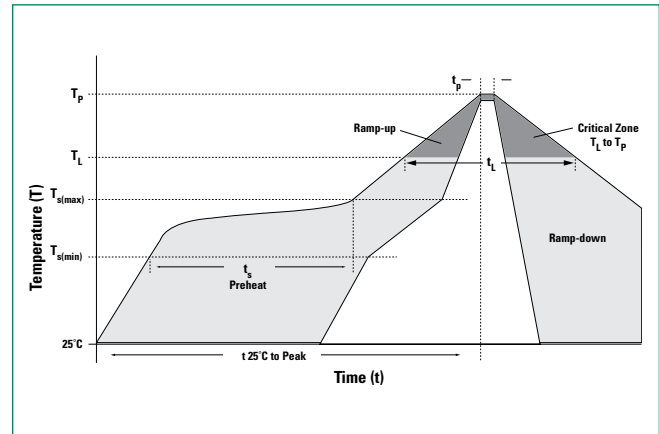

### Physical Specifications

<b>Weight</b>	0.00733 ounce, 0.228 grams
<b>Case</b>	JEDEC DO214AB. Void-Free, Transfer-Molded, Thermosetting Plastic Epoxy Meets UL 94V-0
<b>Polarity</b>	Color band denotes cathode for unidirectional components.
<b>Terminal</b>	Matte Tin-plated leads, Solderable per JESD22-B102

### Environmental Specifications

<b>High Temp. Storage</b>	JESD22-A103
<b>HTRB</b>	JESD22-A108
<b>Temperature Cycling</b>	JESD22-A104
<b>MSL</b>	JEDEC-J-STD-020, Level 1
<b>H3TRB</b>	JESD22-A101
<b>RSH</b>	JESD22-A111

### Dimensions

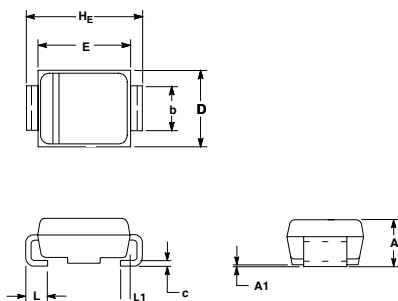

Dim	Inches			Millimeters		
	Min	Nom	Max	Min	Nom	Max
A	0.079	0.087	0.095	2.00	2.22	2.41
A1	0.002	0.004	0.008	0.05	0.10	0.20
b	0.115	0.118	0.125	2.92	3.00	3.18
c	0.006	0.009	0.012	0.15	0.23	0.30
D	0.220	0.230	0.240	5.59	5.84	6.10
E	0.260	0.270	0.280	6.60	6.86	7.11
HE	0.305	0.313	0.320	7.75	7.94	8.13
L	0.030	0.040	0.050	0.76	1.02	1.27
L1	0.020 REF			0.051 REF		

### Soldering Footprint

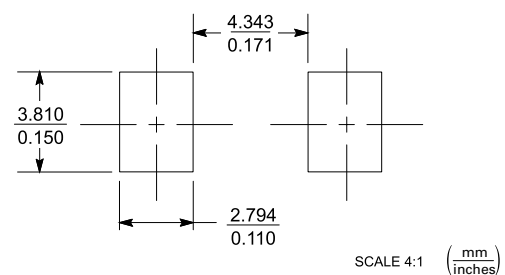

### Ordering Information

Device	Package	Shipping
SZ1.5SMCxxAT3G	SMC (Pb-Free)	2,500 / Tape & Reel

# SZ1.5SMC Series

## Surface Mount > 1500W

### Part Marking System

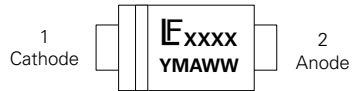

**XXXX** = Device Code (max four digits)  
**Y** = Year  
**M** = Month  
**A** = Assembly Location  
**WW** = Lot Code

### Part Numbering System

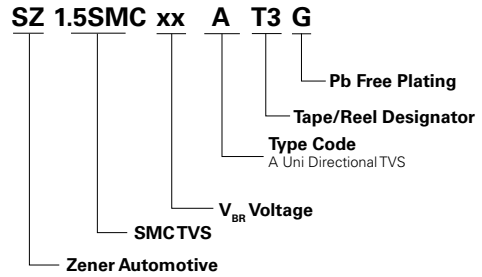

### Tape and Reel Specification

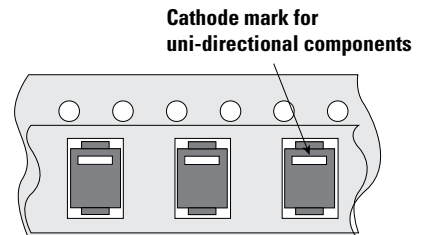
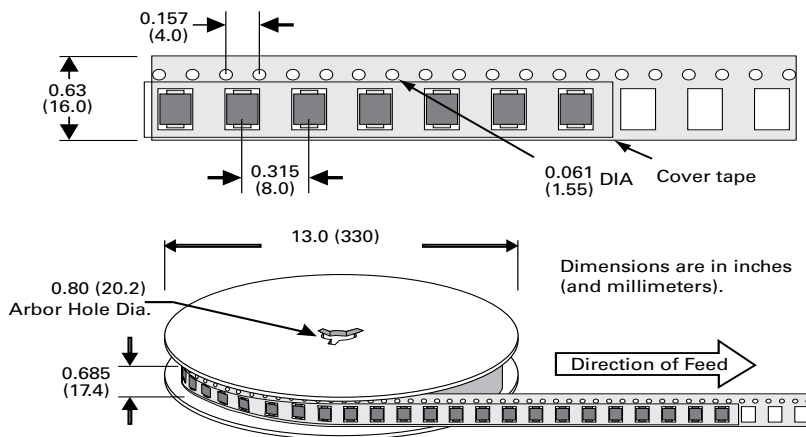

**Disclaimer Notice** - Information furnished is believed to be accurate and reliable. However, users should independently evaluate the suitability of and test each product selected for their own applications. Littelfuse products are not designed for, and may not be used in, all applications. Read complete Disclaimer Notice at: [www.littelfuse.com/disclaimer-electronics](http://www.littelfuse.com/disclaimer-electronics).