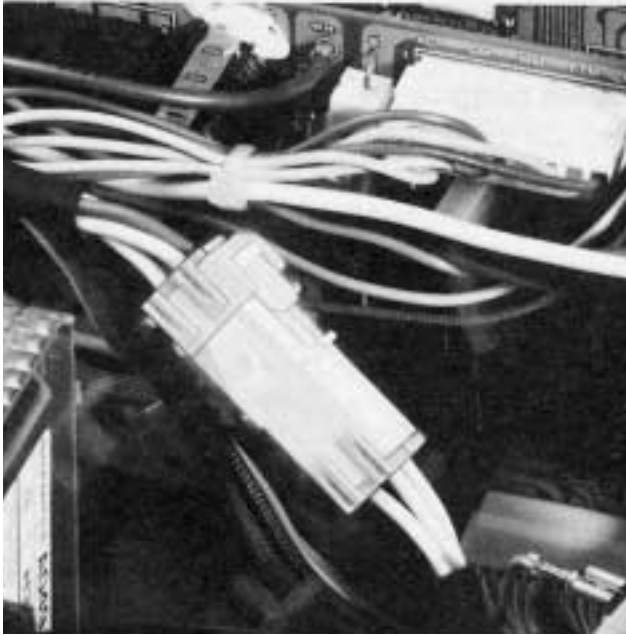

JST

Crimp

5.0mm
(.197") pitch

ZL CONNECTOR

Disconnectable Crimp style Wire-to-wire connectors

ZL connectors are reliable, smoothly mating wire-to-wire connectors.

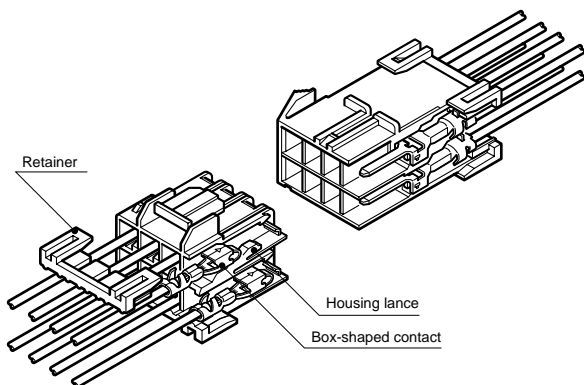

Features

• **Housing lances**

The lances on the resilient housing are not affected by external force. They allow the contact to be easily inserted and securely locked into the housing, and require only a light insertion force.

• **Retainer**

The retainer ensures high reliability by preventing non-insertion or accidental release of the contact. Installed after the contacts are inserted, it locks and secures the contacts at the lance sections.

• **Box-shaped contacts**

Our box-shaped contacts serve as socket contacts in a wide variety of applications from low-voltage, low-current signal circuits to power supply circuits.

• **Mountable on a variety of panels**

Due to our unique panel installation locking mechanisms, the housing can be easily installed on panels of various thicknesses without using tools.

Specifications

- Current rating: 10A AC, DC max.
 - Voltage rating: 300V AC, DC max.
 - Temperature range: -25°C to +90°C
(including temperature rise in applying electrical current)
 - Contact resistance: Initial value/7m Ω max.
After environmental testing/10m Ω max.
 - Insulation resistance: 1,000M Ω min.
 - Withstanding voltage: 1,500V AC/minute
 - Applicable wire: AWG #26 to #16
0.13 to 1.25mm²
 - Applicable panel thickness: 0.7 to 2.4mm(.028" to .094")
- * Contact JST for details.

Note: The current rating varies depending on the number of circuits and the wire size used in each connector.

The table below lists the current rating as a function of the number of circuits and wire size.

Current unit: A

Circuits	Wire size (AWG)					
	#16	#18	#20	#22	#24	#26
2	10	6	5	4	3	2
4	9	5	4	3	3	2
6	8	4	3	3	2	2
8	6	4	3	3	2	2
12	6	4	3	3	2	2
16	5	3	2	2	1	1

Standards

 Recognized E60389

 Certified LR20812

Contact

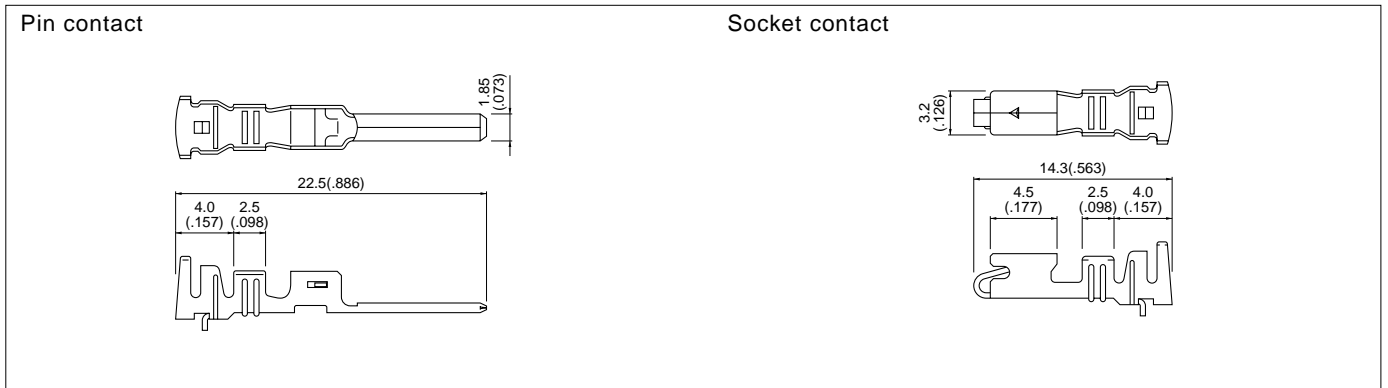

Model No.		Applicable wire			Q'ty / reel
Pin contact	Socket contact	mm ²	AWG #	Insulation O.D. mm(in.)	
SZM-01T-P0.7	SZF-01T-P0.7	0.13 to 0.5	26 to 20	1.3 to 2.7 (.051 to .106)	3,000
SZM-41T-P0.7	SZF-41T-P0.7	0.75 to 1.25	18 to 16	1.9 to 3.1 (.075 to .122)	
		0.3+0.3 to 0.5+0.5	22+22 to 20+20	1.7+1.7 to 2.0+2.0 (.067+.067 to .079+.079)	

Material and Finish

Phosor bronze , tin-plated

Note: Contact JST for special products.

Housing

Material: Housing...Nylon 6, UL94V-0, white
Retainer...Glass-filled nylon 66, UL94V-0, ivory

Circuits	Voltage rating	Current rating	Receptacle housing(for pin contact)		Plug housing(for socket contact)		Retainer	
2	300V	10.0A	ZLR-02V 	Q'ty / bag 500	ZLP-02V 	Q'ty / bag 500	ZLS-02V (Used with both housings with 2 and 4 circuits) 	Q'ty / bag 1,000
4	300V	9.0A	ZLR-04V 	Q'ty / bag 500	ZLP-04V 	Q'ty / bag 500		Q'ty / bag 1,000

ZL CONNECTOR

Housing

Material: Housing...Nylon 6, UL94V-0, white
Retainer...Glass-filled nylon 66, UL94V-0, ivory

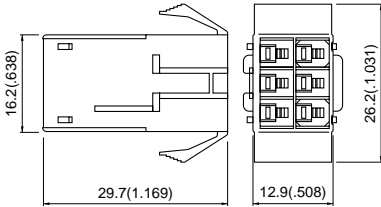
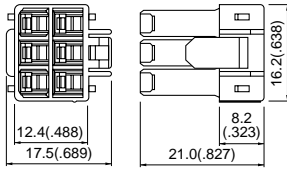
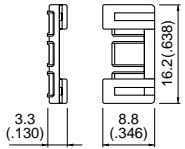
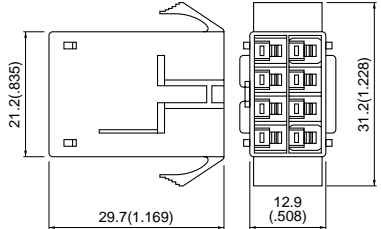
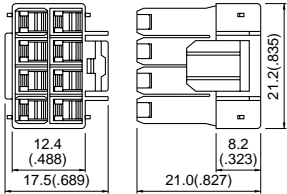
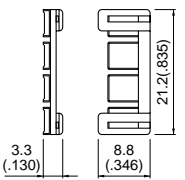
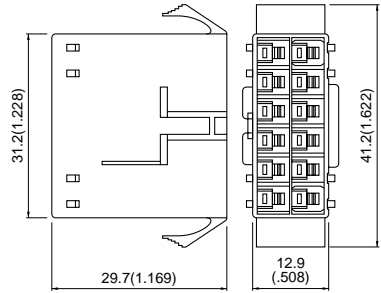
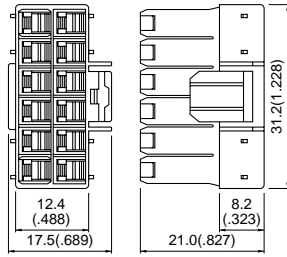
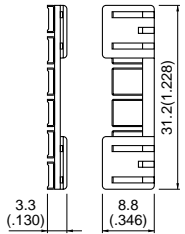
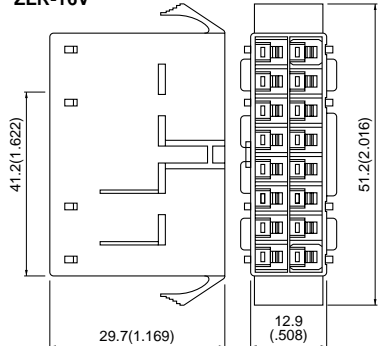
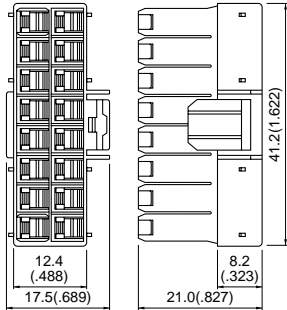
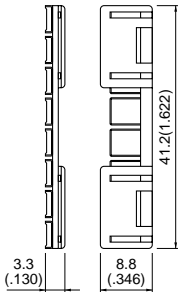
Circuits	Voltage rating	Current rating	Receptacle housing(for pin contact)		Plug housing(for socket contact)		Retainer	
6	300V	8.0A	ZLR-06V 	Q'ty / bag 500	ZLP-06V 	Q'ty / bag 500	ZLS-03V 	Q'ty / bag 1,000
8	300V	6.0A	ZLR-08V 	Q'ty / bag 500	ZLP-08V 	Q'ty / bag 500	ZLS-08V 	Q'ty / bag 1,000
12	300V	6.0A	ZLR-12V 	Q'ty / bag 200	ZLP-12V 	Q'ty / bag 200	ZLS-12V 	Q'ty / bag 1,000
16	300V	5.0A	ZLR-16V 	Q'ty / bag 200	ZLP-16V 	Q'ty / bag 200	ZLS-16V 	Q'ty / bag 1,000

Note: 1. ZL connectors with any number of circuits can be used either panel mounted or free hanging. The panel hole dimensions are given on the next page.
2. Contact JST for special products.

Contact position location numbers

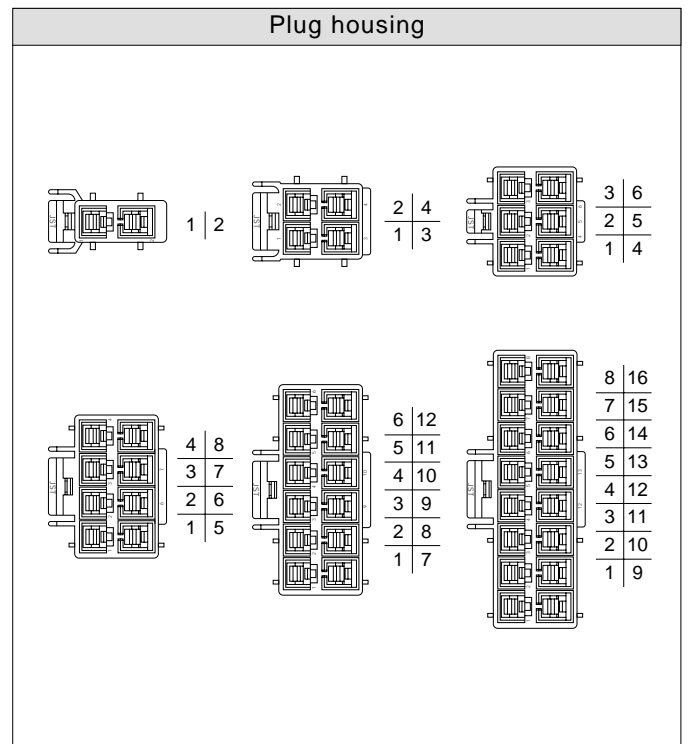
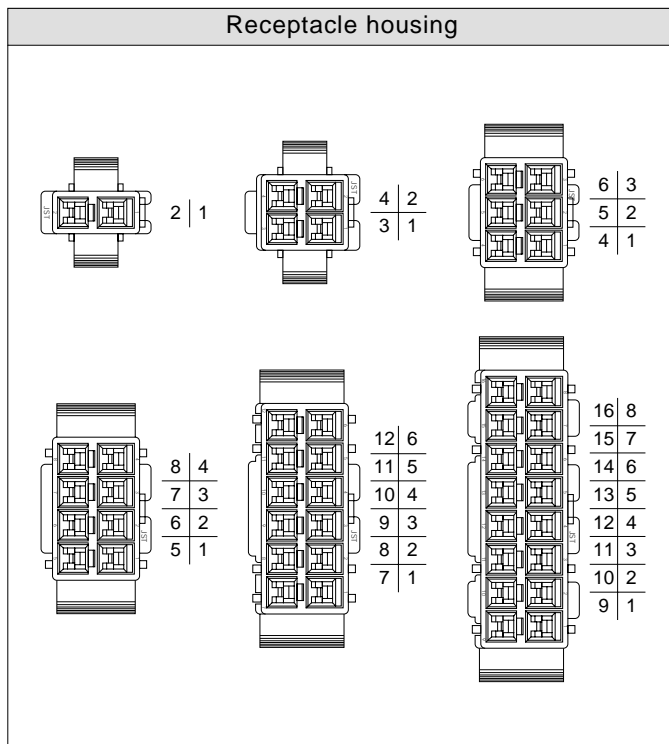
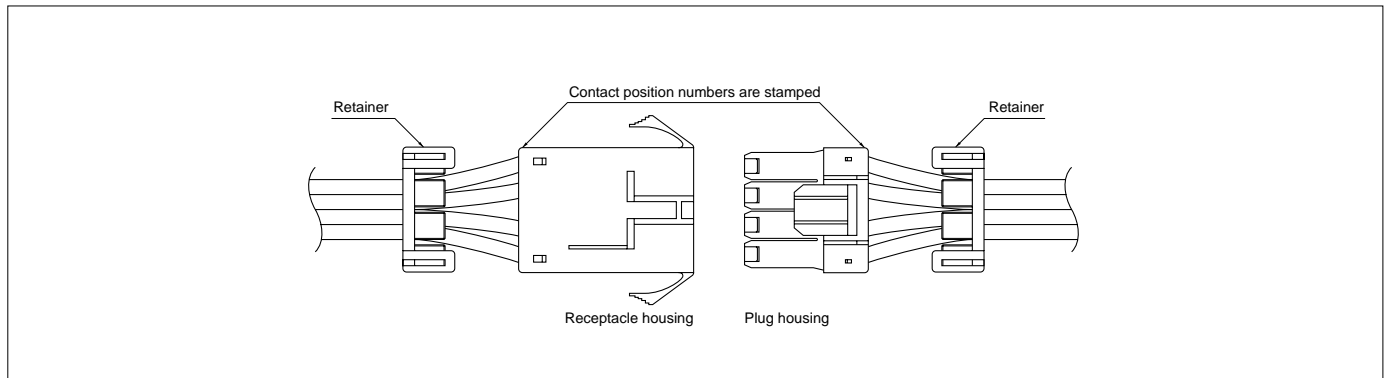

ZL CONNECTOR

Panel layout

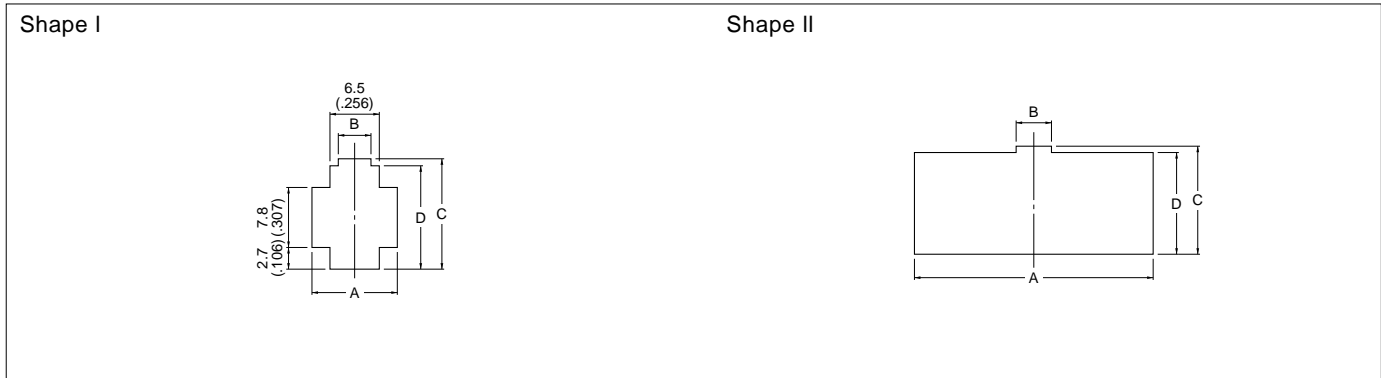

Circuits	Receptacle housing	Panel hole shape	Panel dimensions mm(in.)				General tolerance ± 0.13 ($\pm .005$)	Applicable panel thickness mm(in.)
			A	B	C	D		
2	ZLR-02V	I	11.5(.453)	4.4(.173)	13.95(.549)	13.2(.520)	0.7 to 2.4 (0.28 to .094)	
4	ZLR-04V	II	16.5(.650)	5.2(.205)	13.95(.549)	13.2(.520)		
6	ZLR-06V	II	21.5(.846)	5.2(.205)	13.95(.549)	13.2(.520)		
8	ZLR-08V	II	26.5(1.043)	5.2(.205)	13.95(.549)	13.2(.520)		
12	ZLR-12V	II	36.5(1.437)	5.2(.205)	13.95(.549)	13.2(.520)		
16	ZLR-16V	II	46.5(1.831)	5.2(.205)	13.95(.549)	13.2(.520)		

Note:

1. Punch holes in the panel according to the sketch and table shown above. Burrs must be removed.
2. The strength of the panel must be considered when punching two or more holes.
3. The connector must be inserted from the same side as the hole is punched.

Assembly layout

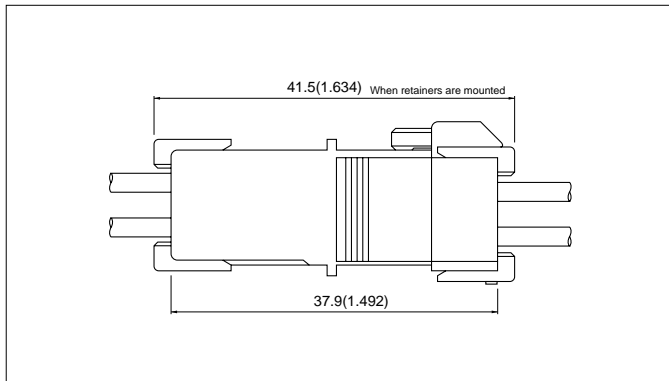

Circuits	Dimensions mm(in.)
2, 4	18.1(.713)
6, 8, 12, 16	17.5(.689)

Applicator for the semi-automatic press AP-K2N

Contact	Crimp applicator MKS-L		Compact crimp applicator MKS-LS		Strip-crimp applicator MKS-SC
	with safety cover	without safety cover	with safety cover	without safety cover	with safety cover
SZF-01T-P0.7	APLMK SZF/M01-07	APLNC SZF/M01-07	-	-	-
SZM-01T-P0.7	APLMK SZF/M01-07	APLNC SZF/M01-07	-	-	-
SZF-41T-P0.7	APLMK SZF/M41-07	APLNC SZF/M41-07	-	-	-
SZM-41T-P0.7	APLMK SZF/M41-07	APLNC SZF/M41-07	-	-	-