

Package: QFN, 6 mmx6 mm



Product Description

RFMD's SZM-2166Z is a high linearity class AB Heterojunction Bipolar Transistor (HBT) amplifier housed in a low-cost surface-mountable plastic Q-FlexN multi-chip module package. This HBT amplifier is made with InGaP on GaAs device technology and fabricated with MOCVD for an ideal combination of low cost and high reliability. This product is specifically designed for 802.16 customer premises equipment (CPE) terminals in the 2.3GHz to 2.7GHz bands. It can run from a 3V to 6V supply. The external output match and bias adjustability allows load line optimization for other applications over narrower bands. It features an output power detector, on/off power control, and high RF overdrive robustness. A 20dB step attenuator feature can be utilized by switching the second stage Power up/down control. This product features a RoHS compliant and Green package with matte finish, designated by the "Z" suffix

Optimum Technology Matching® Applied

- GaAs HBT
- GaAs MESFET
- InGaP HBT
- SiGe BiCMOS
- Si BiCMOS
- SiGe HBT
- GaAs pHEMT
- Si CMOS
- Si BJT
- GaN HEMT
- RF MEMS

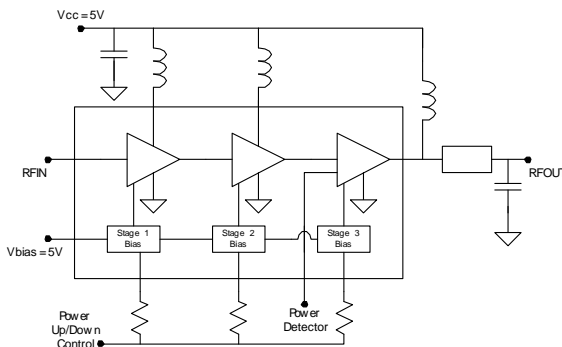

Features

- $P_{1dB} = 35\text{ dBm}$ at 6V
- Three Stages of Gain: 37 dB
- 802.11g 54 Mb/s Class AB Performance
- $P_{OUT} = 27\text{ dBm}$ at 2.5% EVM, $V_{CC} = 6\text{V}$, 878 mA
- Active Bias with Adjustable Current
- On-Chip Output Power Detector
- Low Thermal Resistance
- Power Up/Down Control $< 1\mu\text{s}$
- Attenuator step 20dB at $V_{PC2} = 0\text{V}$

Applications

- 802.16 WiMAX Driver or Output Stage
- 802.11b/g WiFi, WiFi
- CPE Terminal Applications

Parameter	Specification			Unit	Condition
	Min.	Typ.	Max.		
Frequency of Operation	2300		2700	MHz	
Output Power at 1dB Compression		35		dBm	2.7 GHz
Small Signal Gain	34.5	36		dB	2.7 GHz
EVM		2.5		%	27 dBm Output power EVM 802.11g 54 Mb/s-2.7 GHz
Third Order Suppression		-40	-35	dBc	($P_{OUT} = 23\text{ dBm}$ per tone)-2.7 GHz
Noise Figure		8.3		dB	2.7 GHz
Worst Case Input Return Loss	10	14		dB	2.5 GHz to 2.7 GHz
Worst Case Output Return Loss	13	14		dB	2.5 GHz to 2.7 GHz
Output Voltage Range		0.9 to 1.8		V	$P_{OUT} = 10\text{ dBm}$ to 33 dBm
Quiescent Current	615	724	832	mA	$V_{CC} = 6\text{V}$
Power Up Control Current		4		mA	$V_{PC} = 6\text{V}$, $I_{VPC1} + I_{VPC2} + I_{VPC3}$
V_{CC} Leakage Current			100	μA	$V_{CC} = 6\text{V}$, $V_{PC} = 0\text{V}$
Thermal Resistance		12		$^{\circ}\text{C}/\text{W}$	junction - lead

Test Conditions: 2.5 GHz to 2.7 GHz App circuit, $Z_0 = 50\Omega$, $V_{CC} = 6.0\text{V}$, $I_q = 724\text{ mA}$, $T_{BP} = 30^{\circ}\text{C}$

Absolute Maximum Ratings

Parameter	Rating	Unit
VC3 Collector Bias Current (I_{VC3})	1500	mA
VC2 Collector Bias Current (I_{VC2})	500	mA
VC1 Collector Bias Current (I_{VC1})	150	mA
****Device Voltage (V_D)	9.0	V
Operating Lead Temperature (T_L)	-40 to +85	°C
****Max CW RF output Power for 50Ω continuous long term operation	30	dBm
Max CW RF Input Power for 50Ω output load	26	dBm
Max CW RF Input Power for 10:1 VSWR FR out load	5	dBm
Max Storage Temperature	-40 to +150	°C
Operating Junction Temperature (T_J)	+150	°C
ESD Human Body Model	Class 1B	
Moisture Sensitivity Level	MSL-1	



Caution! ESD sensitive device.

Exceeding any one or a combination of the Absolute Maximum Rating conditions may cause permanent damage to the device. Extended application of Absolute Maximum Rating conditions to the device may reduce device reliability. Specified typical performance or functional operation of the device under Absolute Maximum Rating conditions is not implied.

RoHS status based on EU Directive 2002/95/EC (at time of this document revision).

The information in this publication is believed to be accurate and reliable. However, no responsibility is assumed by RF Micro Devices, Inc. ("RFMD") for its use, nor for any infringement of patents, or other rights of third parties, resulting from its use. No license is granted by implication or otherwise under any patent or patent rights of RFMD. RFMD reserves the right to change component circuitry, recommended application circuitry and specifications at any time without prior notice.

****With specified application circuit
 ****No RF Drive

Operation of this device beyond any one of these limits may cause permanent damage. For reliable continuous operation, the device voltage and current must not exceed the maximum operating values specified in the table on page one.

Bias Conditions should also satisfy the following expression:

$$I_{CQ} V_{CC} < (T_J - T_L) / R_{TH, j}$$

Note: I_{CQ} in this equation is for the stage with the highest current

Typical Performance with appropriate app circuit ($V_{CC}=6V$, $I_{CQ}=655mA$, 802.11g 54Mb/s 64QAM)

Parameter	Unit	2.3	**2.4	***2.5	***2.6	***2.7
		GHz ¹	GHz ¹	GHz ²	GHz ²	GHz ²
Gain at $P_{OUT}=26dBm$	dB	37.5	37.5	37.5	37.0	35.0
P_{1dB}	dBm	34.0	34.0	35.0	35.0	35.0
EVM% at 27dBm Output Power	%	2.3	2.9	1.7	1.7	2.5
Current at P_{OUT} 2.5% EVM	mA	768	779	900	889	878
Input Return Loss	dB	23.0	21.0	14.0	14.0	14.0
Output Return Loss	dB	14.0	11.0	20.0	25.0	18.0

Note 1: Measured with 2.3GHz to 2.4GHz Application circuit

Note 2: Measured with 2.5GHz to 2.7GHz Application circuit

Measured 2.3GHz to 2.4GHz Application Circuit Data ($V_{CC}=V_{PC}=6.0V$, $I_q=653mA$, $T=25^\circ C$)

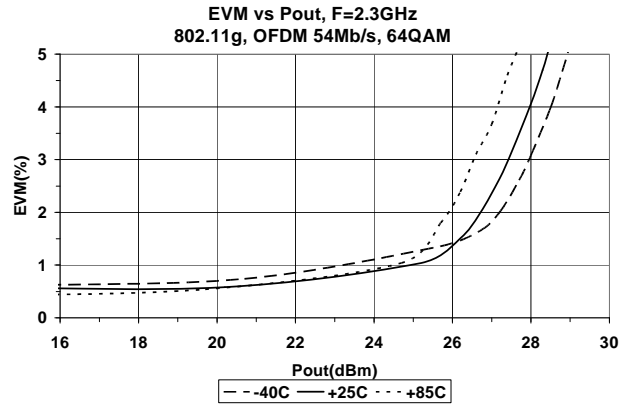
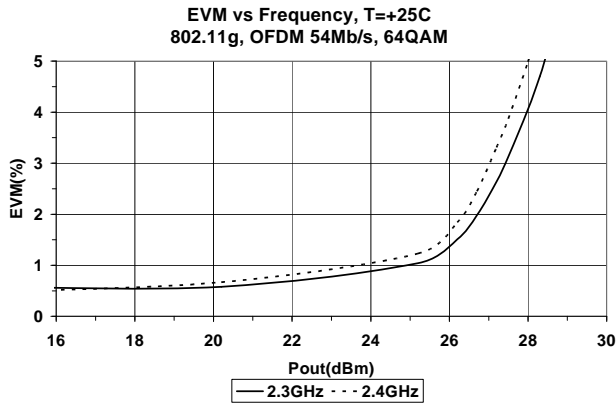

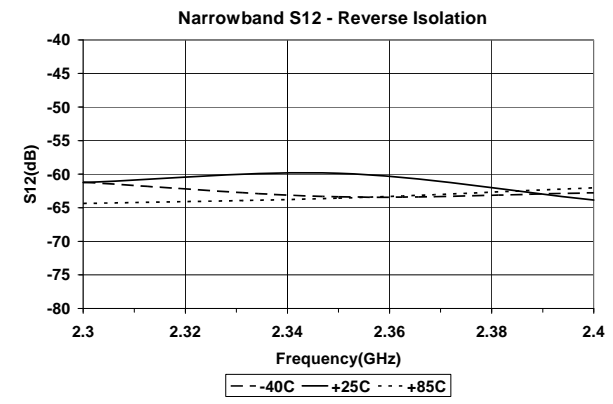
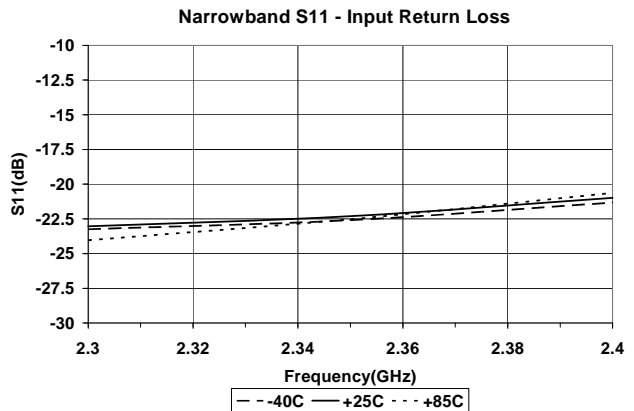
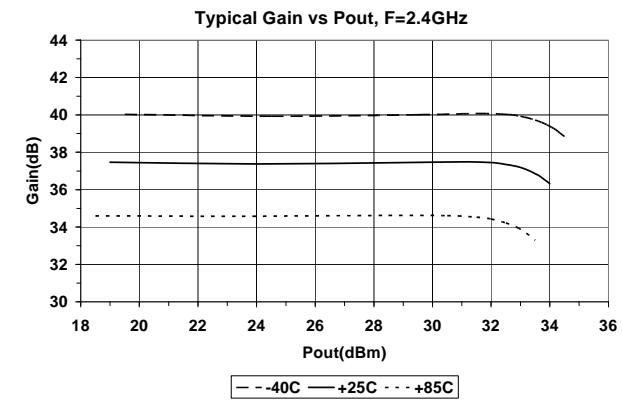
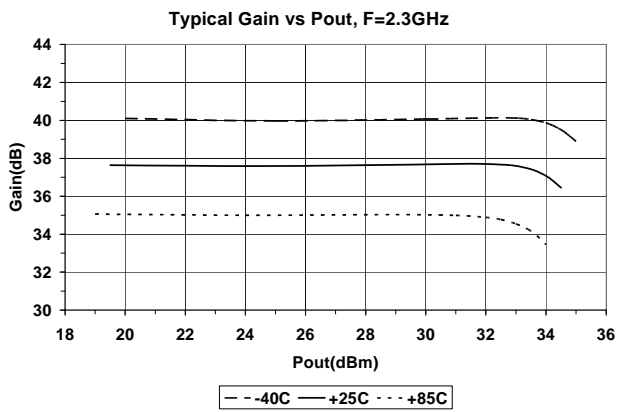
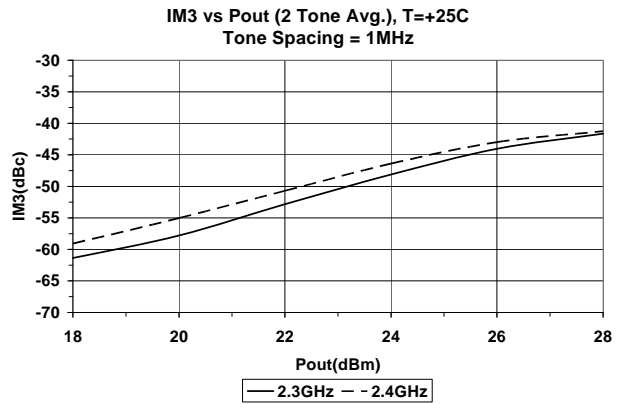
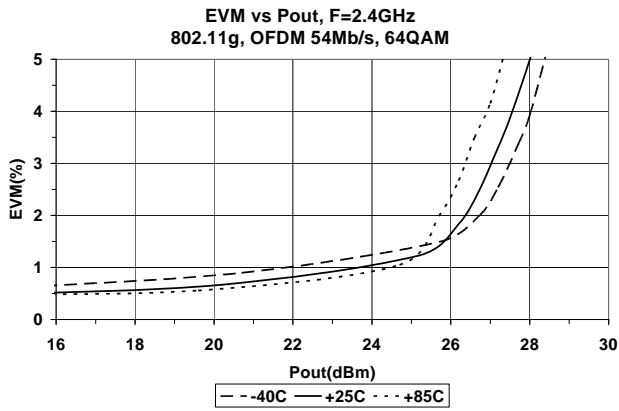

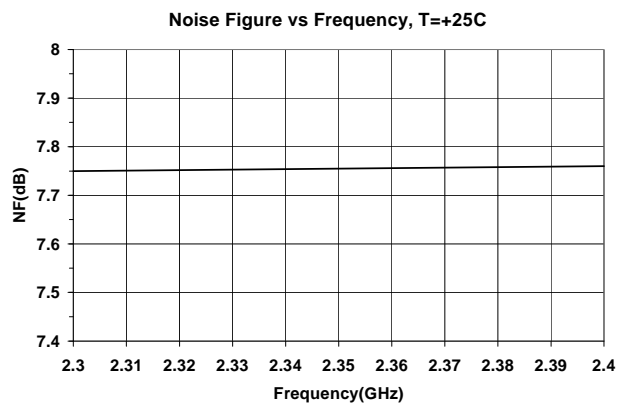
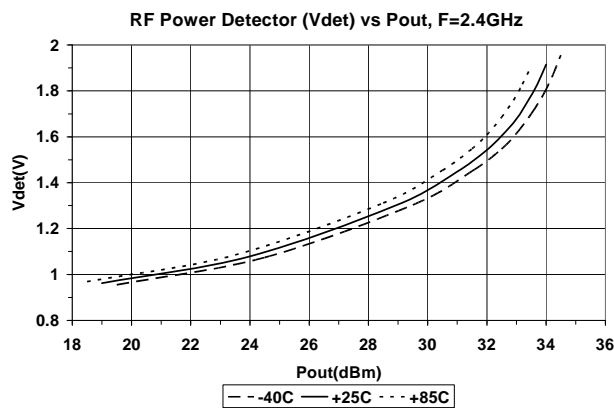
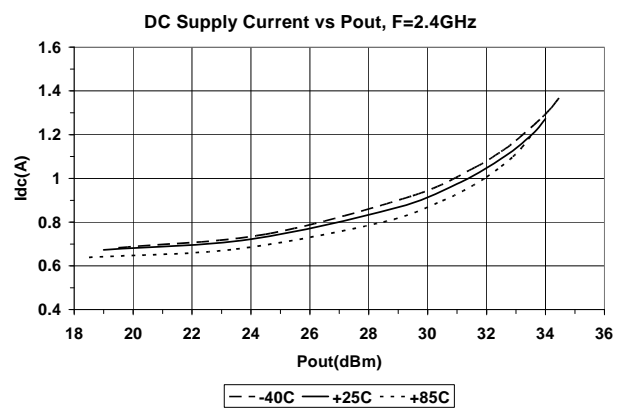
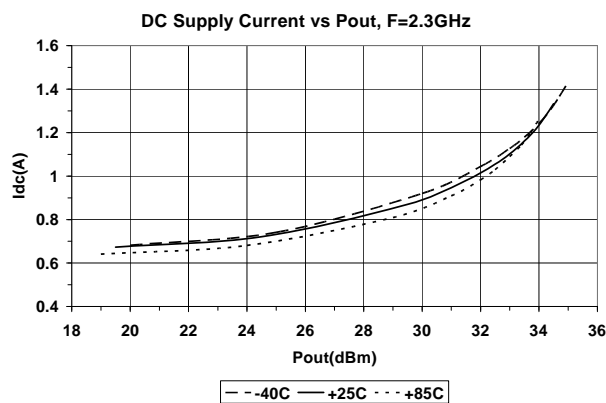
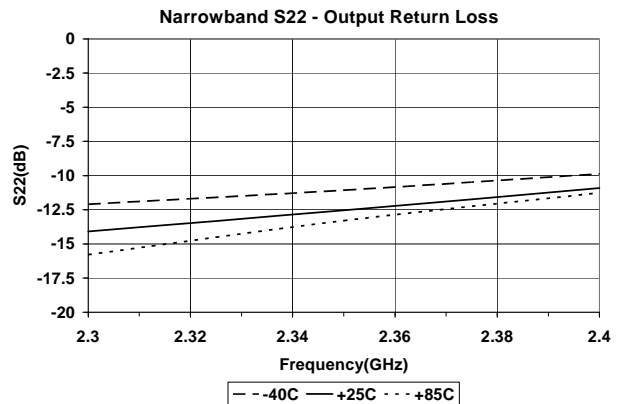
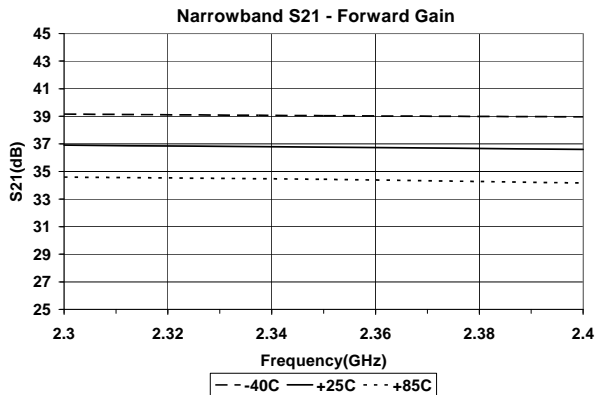

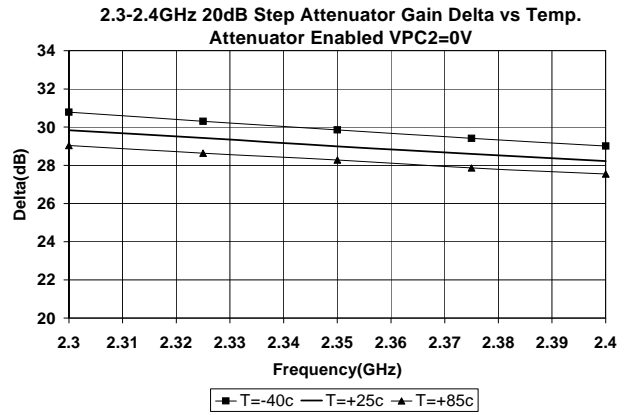
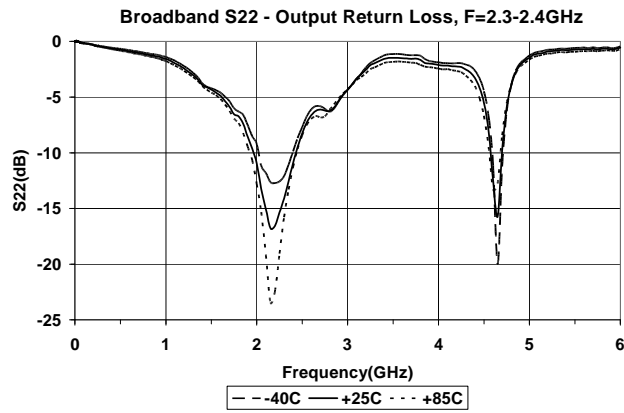
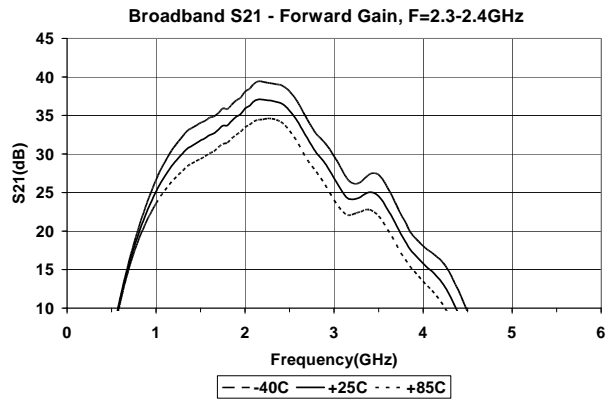
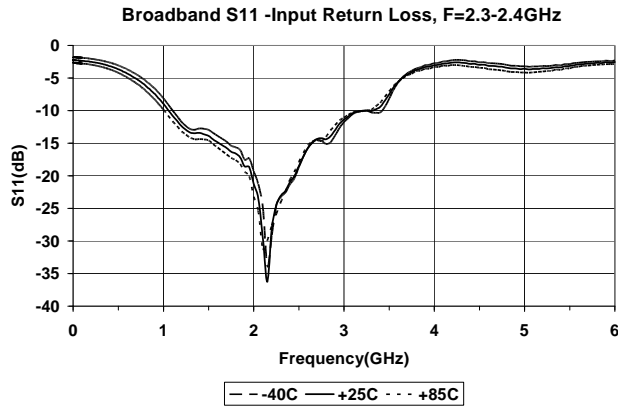

Measured 2.4GHz to 2.5GHz Application Circuit Data ($V_{CC}=V_{PC}=6.0V$, $I_q=653mA$, $T=25^\circ C$)

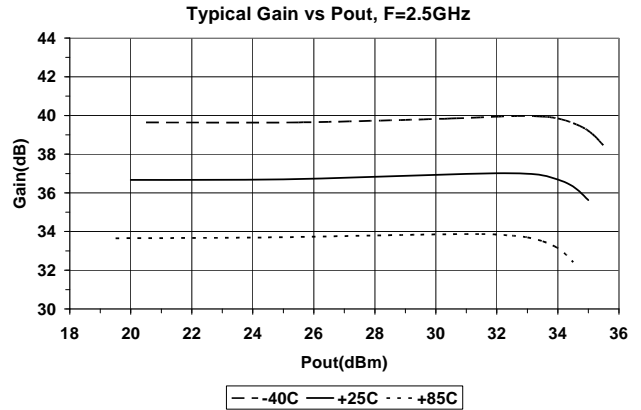
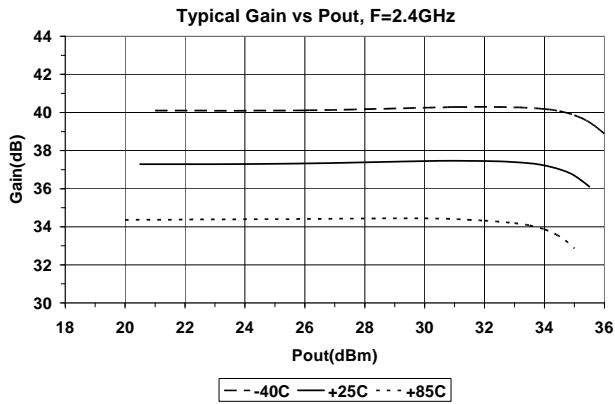
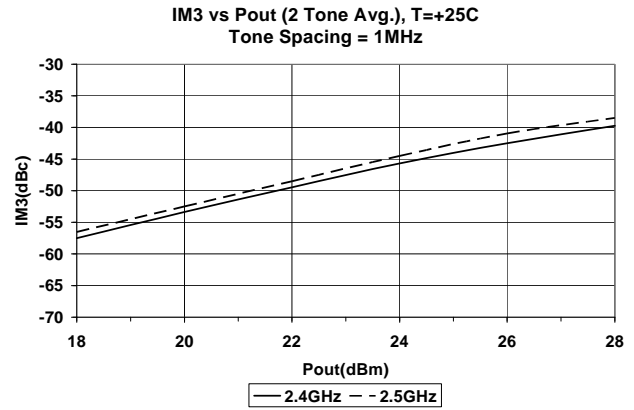
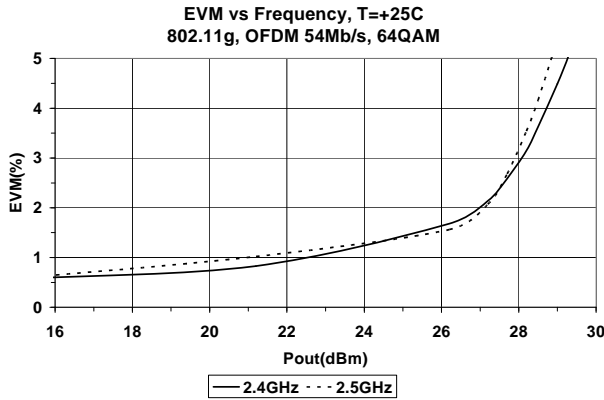
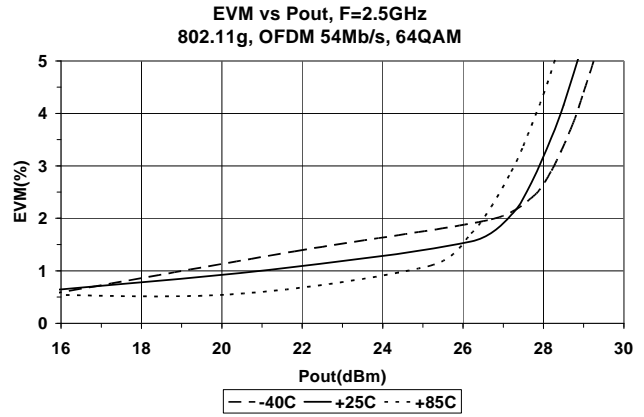
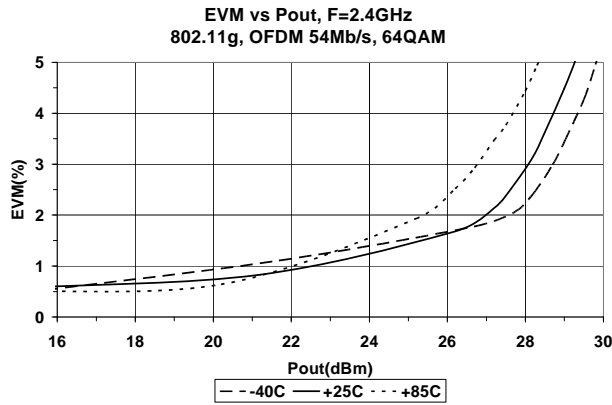

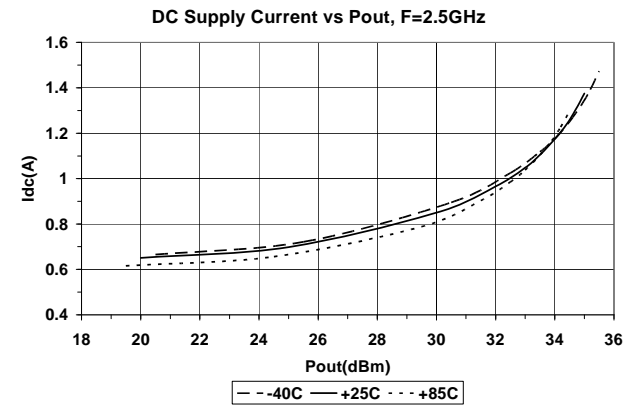
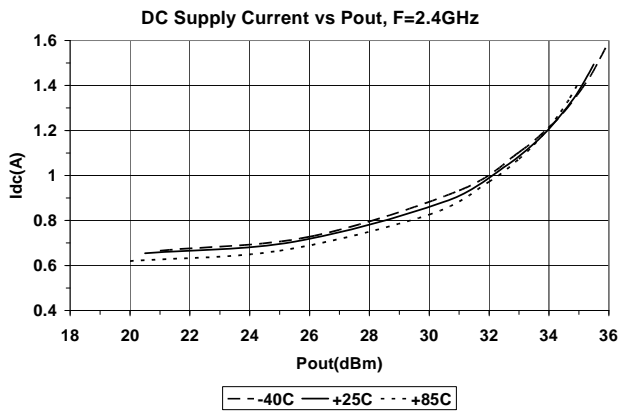
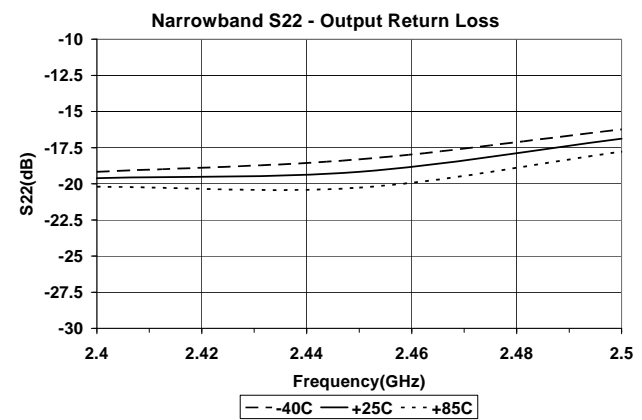
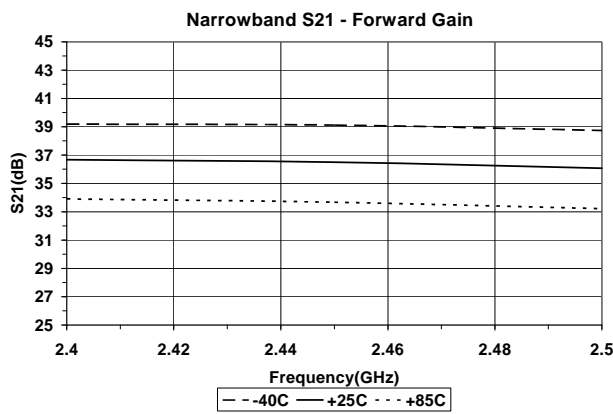
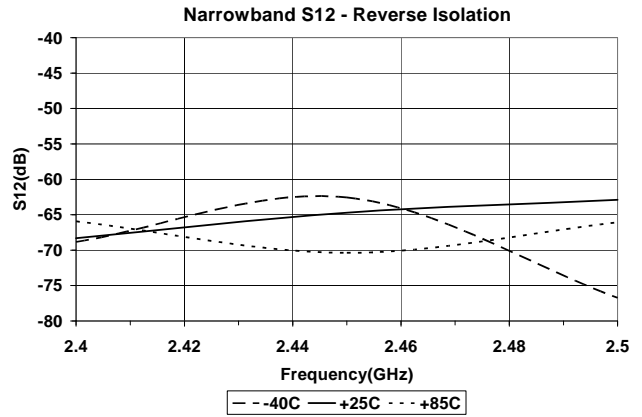
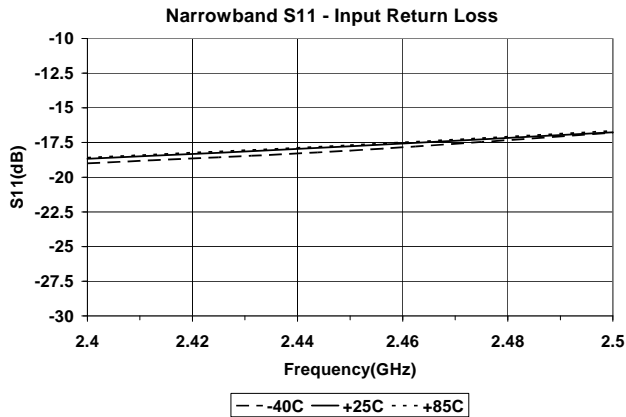

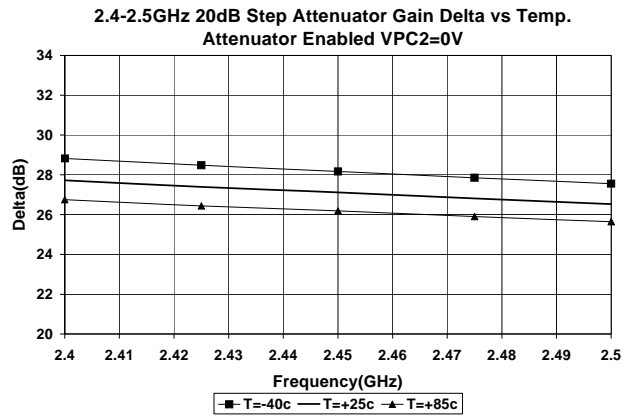
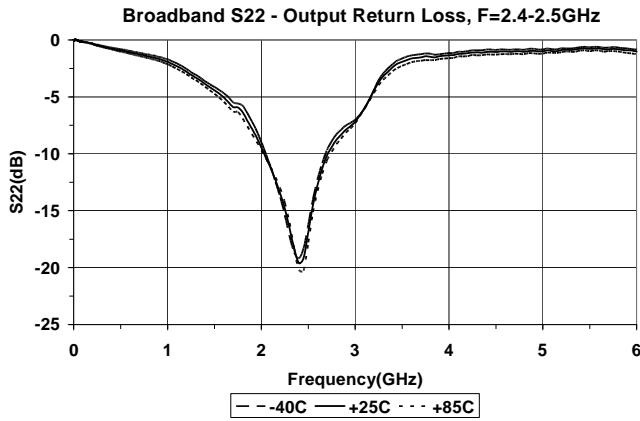
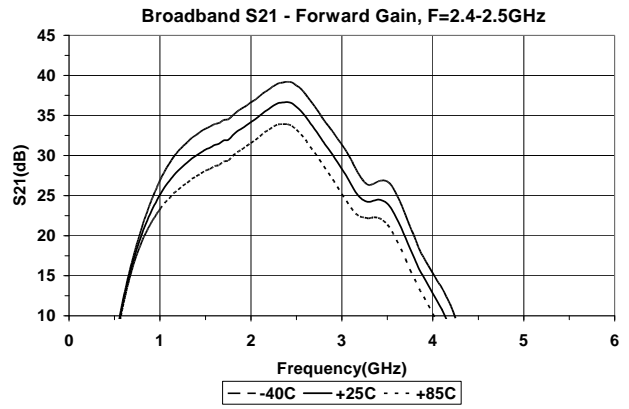
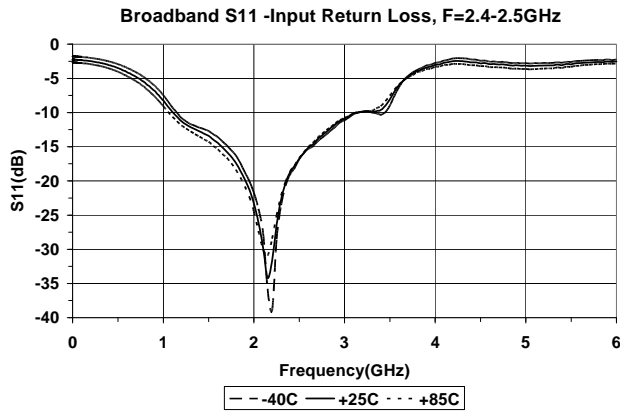
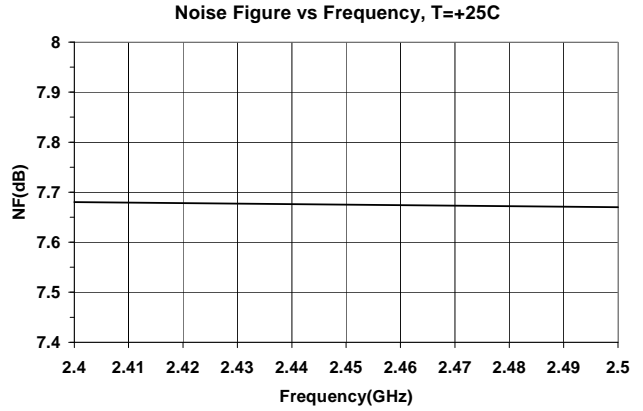
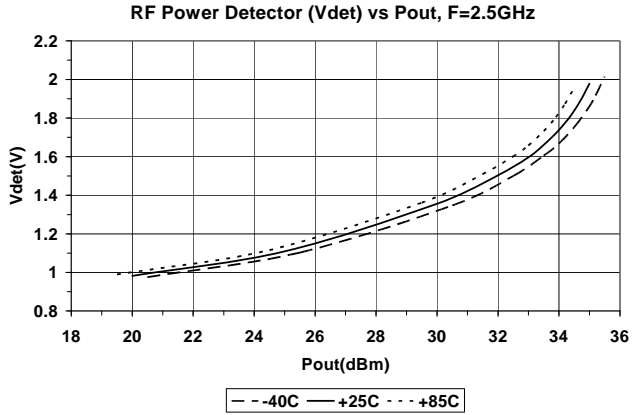

Measured 2.5GHz to 2.7GHz Application Circuit Data ($V_{CC}=V_{PC}=6.0V$, $I_q=724mA$, $T=25^\circ C$)

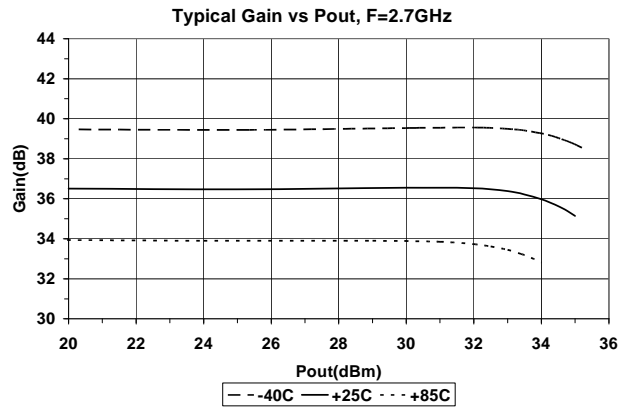
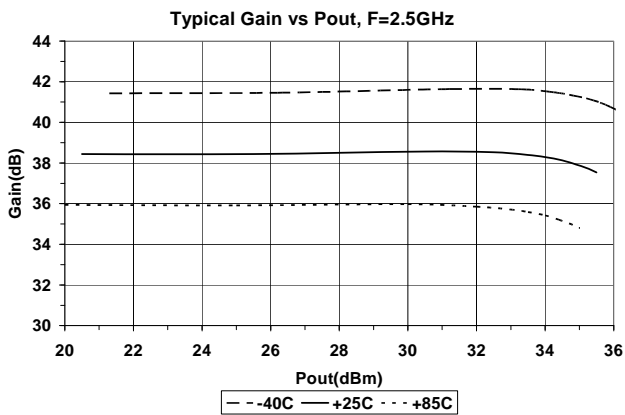
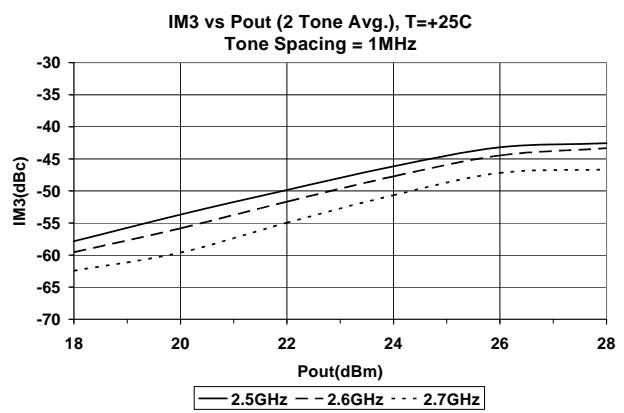
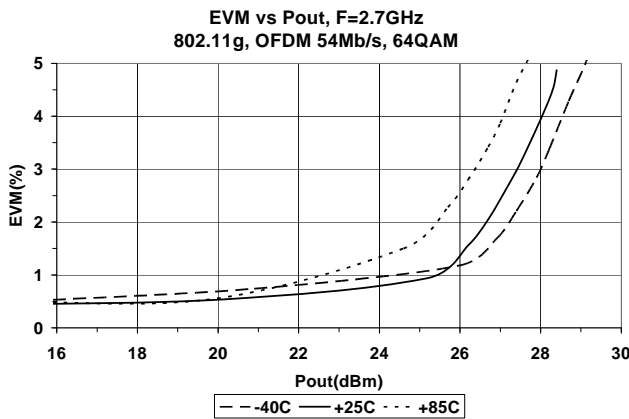
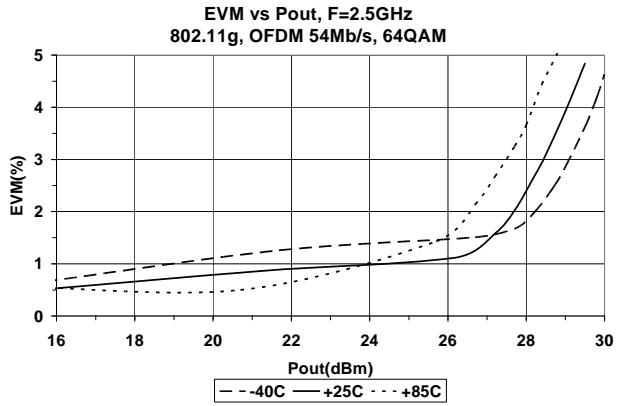
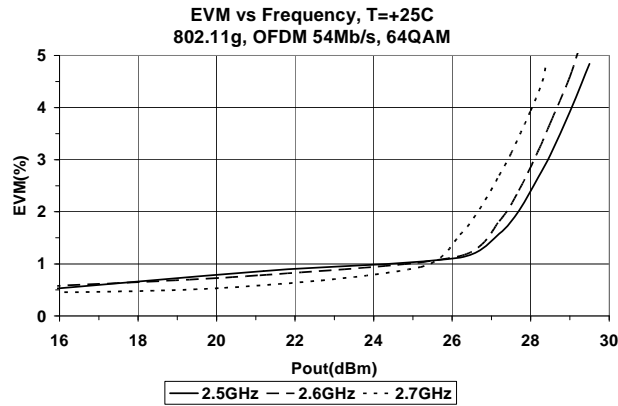

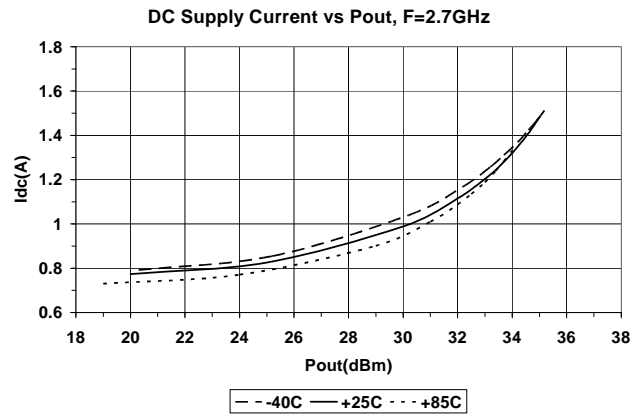
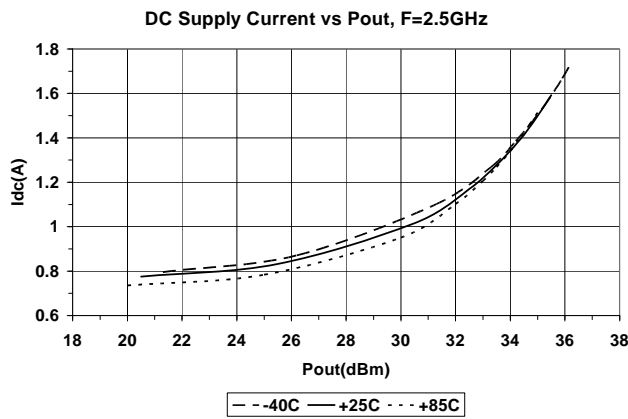
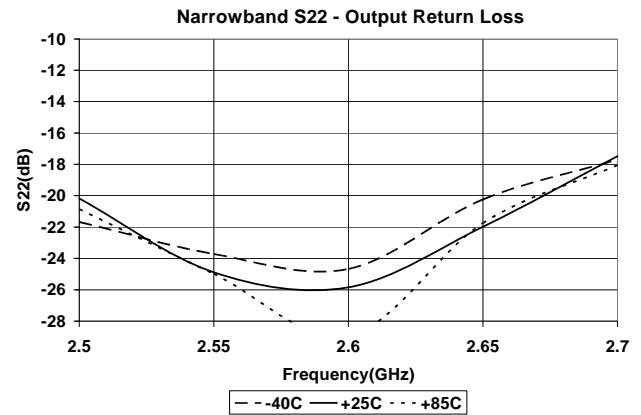
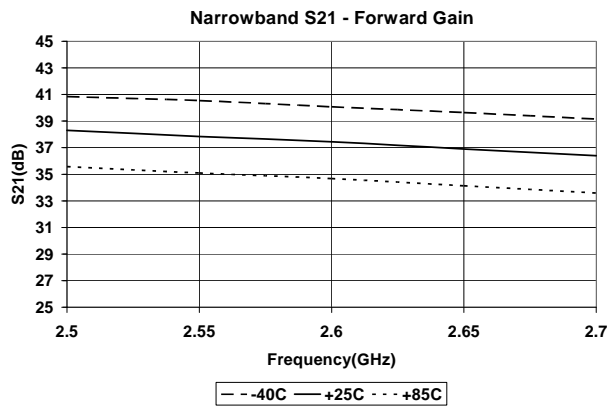
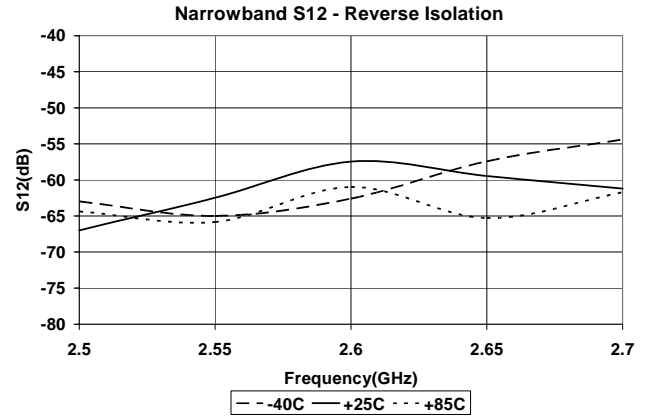
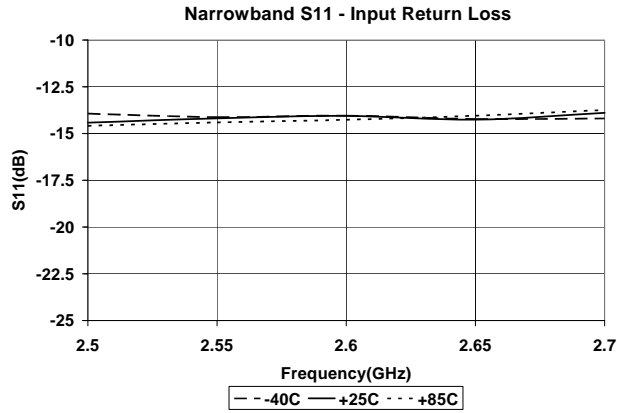

RF Power Detector (Vdet) vs Pout, F=2.7GHz

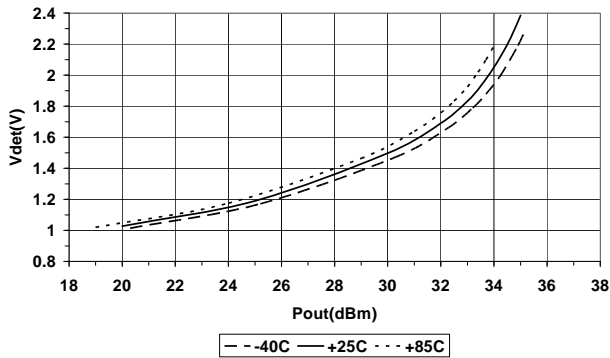

Noise Figure vs Frequency, T=+25C

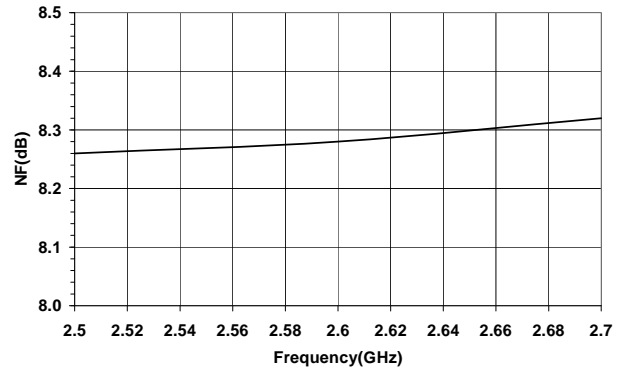

Broadband S11 -Input Return Loss, F=2.5-2.7GHz

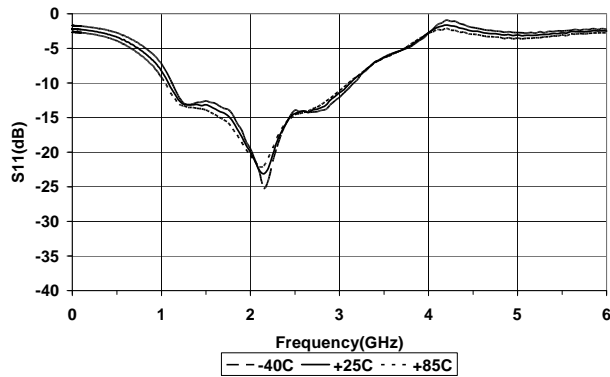

Broadband S21 - Forward Gain, F=2.5-2.7GHz

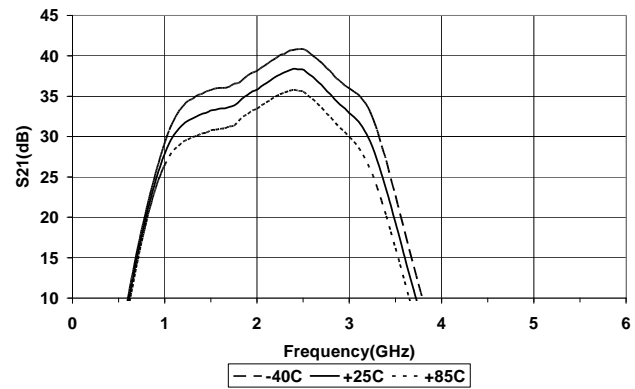

Broadband S22 - Output Return Loss, F=2.5-2.7GHz

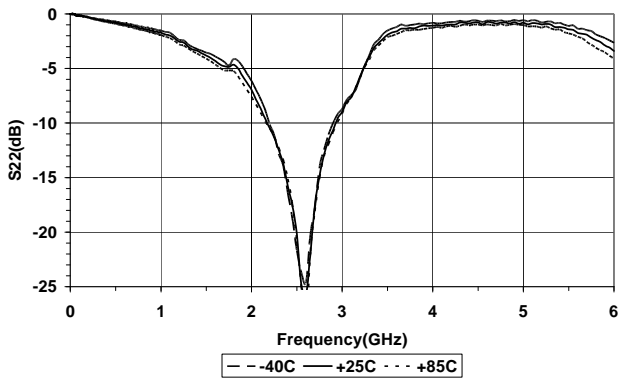

2.5-2.7GHz 20dB Step Attenuator Gain Delta vs Temp. Attenuator Enabled VPC2=0V

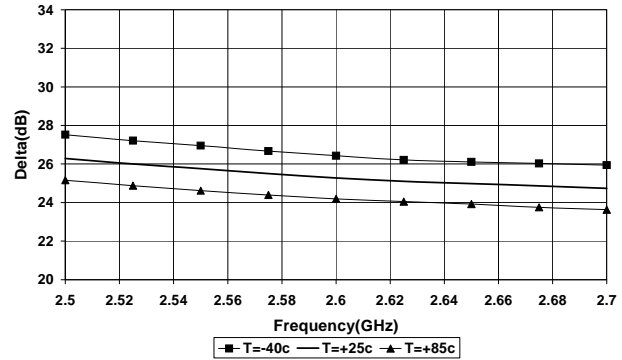

Pin	Function	Description
7, 11, 12, 22, 29, 31, 39, 40	NC	These are no connect (NC) pins and are not wired inside the package. It is recommended to connect them as shown in the application circuit to achieve the stated performance.
1, 10, 21, 30	GND	These pins are internally grounded inside the package to the backside ground paddle. It is recommended to also ground them externally to the package to achieve the specified performance.
2	VC1	This is the collector of the first stage.
3	VBIAS12	This is the supply voltage for the active bias circuit of the 1st and 2nd stages.
4-5	R1A-R2A	A resistor is tied across these pins internal to the package.
6	RF IN	This is the RF input pin. It is DC grounded inside the package. Do not apply DC voltage to this pin.
8	VPC1	Power up/down control pin for the 1st stage. An external series resistor is required for proper setting of bias levels depending on control voltage. The voltage of this pin should never exceed the voltage on pin 3 by more than 0.5V unless the supply current from pin 3 is limited <10mA.
9	VPC2	Power up/down control pin for the 2nd stage. Power down VPC<1V for step attenuator function enable. An external series resistor is required for proper setting of bias levels depending on control voltage. The voltage on this pin should never exceed the voltage on pin 3 by more than 0.5V unless the supply current from pin 3 is limited<10mA.
13, 38	VC2A, VC2B	These two pins are connected internal to the package and connect to the 2nd stage collector. To achieve specified performance, the layout of these pins should match the Recommended Land Pattern.
14-15 17-18 33-34 36-37	C1A-C2A C3A-C4A C4B-C3B C2B-C1B	These pins have capacitors across them internal to the package as shown in the below schematic. They are used as tuning and RF coupling elements between the 2nd and 3rd stage.
16, 35	VB3A, VB3B	These are the connections to the base of the 3rd stage output device. To achieve specified performance, the layout of these pins should match the Recommended Land Pattern.
19	VPC3	Power up/down control pin for the 2nd stage. An external series resistor is required for proper setting of bias levels depending on control voltage. The voltage on this pin should never exceed the voltage on pin 32 by more than 0.5V unless the supply current from pin 33 is limited <10mA.
20	VDET	This is the output port for the power detector. It samples the power at the input of the 3rd stage.
23-28	RF OUT	These are the RF output pins and DC connections to the 3rd stage collector.
32	VBIAS3	This is the supply voltage for the active bias circuit of the 3rd stage.

2.3GHz to 2.4GHz Evaluation Board Schematic

$$V_{CC}=V+=V_{PC}=6.0V$$

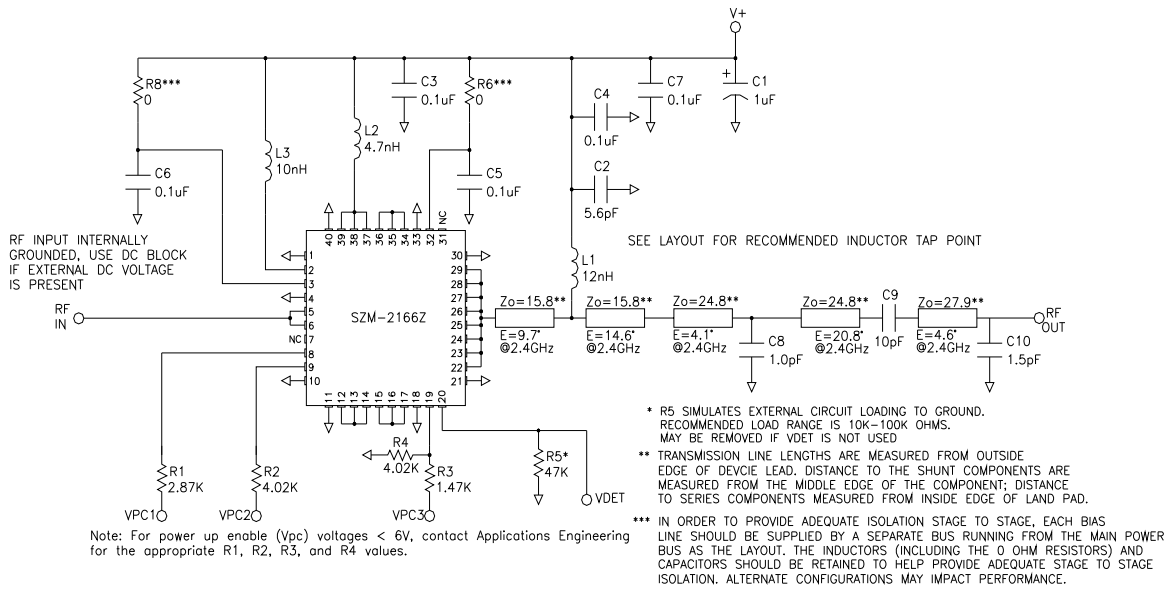

2.3GHz to 2.4GHz Evaluation Board Layout

$V_{CC}=V+=V_{PC}=6.0V$

Board material GETEK, 10mil thick, Dk=3.9, 2oz copper

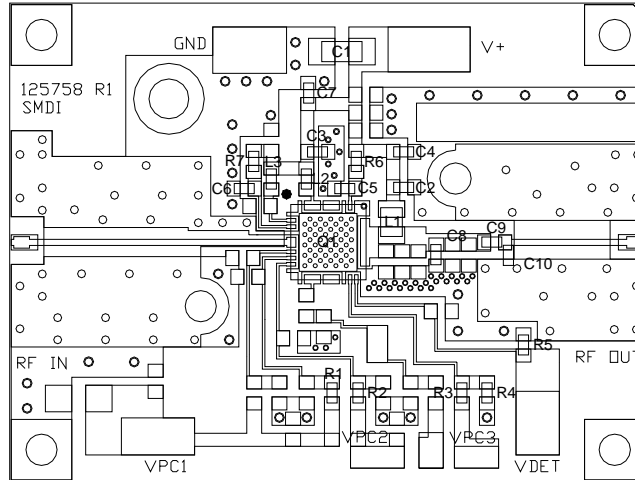

Bill of Materials

DESG	Description	Notes
Q1	SZM-2166Z	6mmx6mm QFN
R1	2.87K Ω , 0603 1%	0402 may be used.
R2, 4	4.02K Ω , 0603 1%	0402 may be used.
R3	1.47K Ω , 0603 1%	0402 may be used.
R5	47K Ω , 0603	0402 may be used.
R6, 7	0 Ω , 0603	0402 may be used.
C1	1uF 16V MLCC CAP	Tantalum ok for EVM performance. Use MLCC type for best IM3 levels.
C2	5.6pF CAP, 0603	NPO ROHM MCH185A5R6DK or equiv.
C3, 4, 5, 6, 7	0.1uF CAP, 0603	X7R 0402 ok, ROHM MCH182CN104K or equiv.
C8	1.0pF CAP, 0603	NPO, low ESR, ATC 600S1R0CW250 or equiv.
C9	10pF CAP, 0603	NPO, low ESR, ATC 600S100JW250 or equiv.
C10	1.5pF CAP, 0603	NPO, low ESR, ATC 600S1R5JW250 or equiv.
L1	12nH IND 0805	Coilcraft 0805HQ - 12NXJBB
L2	4.7nH IND, 0603	TOKO 0603 - LL1608FH4N7J
L3	10nH IND, 0603	TOKO 0603 - LL1608FH10NJ

2.4GHz to 2.5GHz Evaluation Board Schematic

$$V_{CC}=V+=V_{PC}=6.0V$$

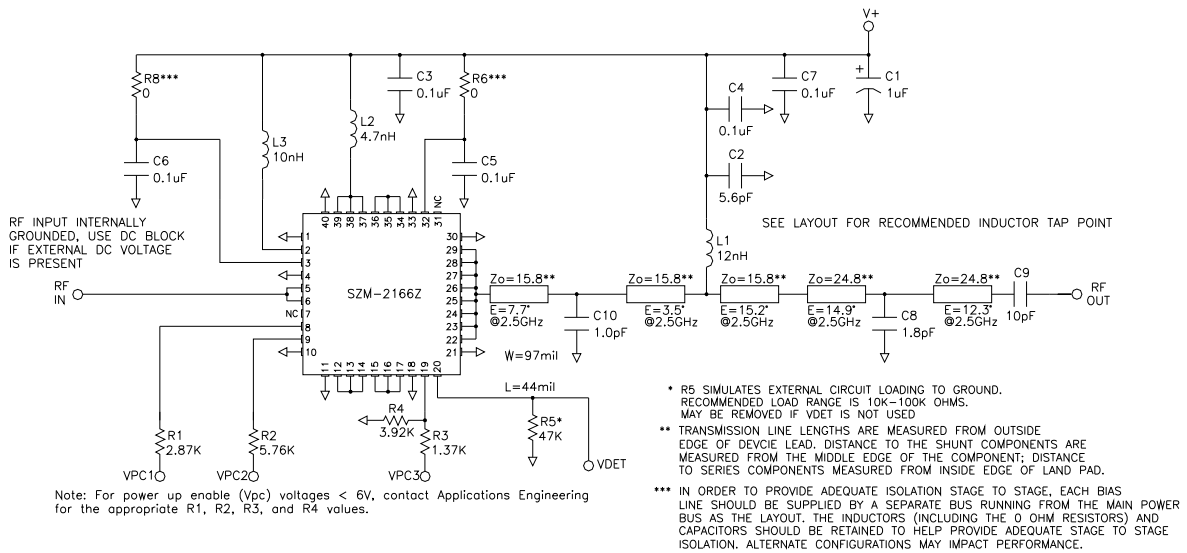

2.4GHz to 2.5GHz Evaluation Board Layout

$V_{CC}=V+=V_{PC}=6.0V$

Board material GETEK, 10mil thick, Dk=3.9, 2oz copper

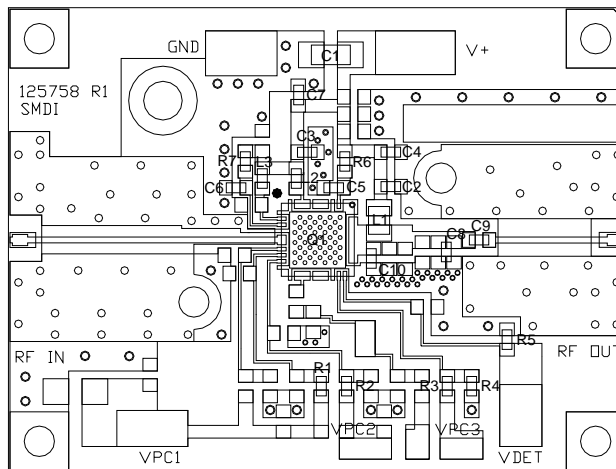

Bill of Materials

DESG	Description	Notes
Q1	SZM-2166Z	6mmx6mm QFN
R1	2.87K Ω , 0603 1%	0402 may be used.
R2	5.76K Ω , 0603 1%	0402 may be used.
R3	1.37K Ω , 0603 1%	0402 may be used.
R4	3.92K Ω , 0603 1%	0402 may be used.
R5	47K Ω , 0603	0402 may be used.
R6, 7	0 Ω , 0603	0402 may be used.
C1	1uF 16V MLCC CAP	Tantulum ok for EVM performance. Use MLCC type for best IM3 levels.
C2	5.6pF CAP, 0603	NPO ROHM MCH185A5R6DK or equiv.
C3, 4, 5, 6, 7	0.1uF CAP, 0603	X7R 0402 ok, ROHM MCH182CN104K or equiv.
C8	1.8pF CAP, 0603	NPO, low ESR, ATC 600S1R8CW250 or equiv.
C9	10pF CAP, 0603	NPO, low ESR, ATC 600S100JW250 or equiv.
C10	1.0pF CAP, 0603	NPO, low ESR, ATC 600S1R0JW250 or equiv.
L1	12nH IND 0805	Coilcraft 0805HQ - 12NXJBB
L2	4.7nH IND, 0603	TOKO 0603 - LL1608FH4N7J
L3	10nH IND, 0603	TOKO 0603 - LL1608FH10NJ

2.5GHz to 2.7GHz Evaluation Board Layout

$V_{CC}=V+=V_{PC}=6.0V$

Board material GETEK, 10mil thick, Dk=3.9, 2oz copper

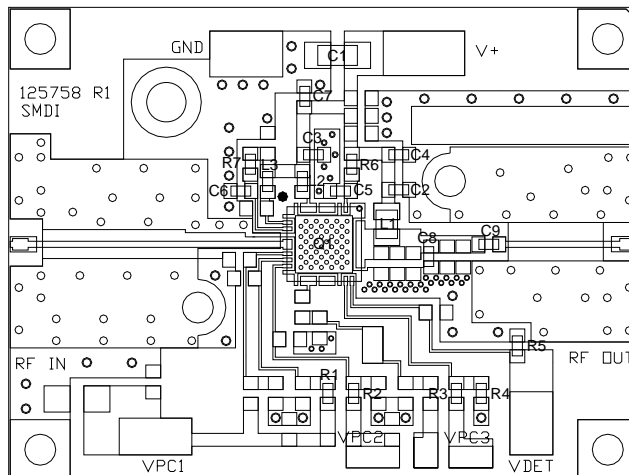

Bill of Materials

DESG	Description	Notes
Q1	SZM-2166Z	6mmx6mm QFN
R1	2.05K Ω , 0603 1%	0402 may be used.
R2	4.99K Ω , 0603 1%	0402 may be used.
R3	1.37K Ω , 0603 1%	0402 may be used.
R4	4.02K Ω , 0603 1%	0402 may be used.
R5	47K Ω , 0603	0402 may be used.
R6, 7	0 Ω , 0603	0402 may be used.
C1	1uF 16V MLCC CAP	Tantulum ok for EVM performance. Use MLCC type for best IM3 levels.
C2	5.6pF CAP, 0603	NPO ROHM MCH185A5R6DK or equiv.
C3, 4, 5, 6, 7	0.1uF CAP, 0603	X7R 0402 ok, ROHM MCH182CN104K or equiv.
C8	2.0pF CAP, 0603	NPO, low ESR, ATC 600S2ROCW250 or equiv.
C9	10pF CAP, 0603	NPO, low ESR, ATC 600S100JW250 or equiv.
L1	12nH IND 0805	Coilcraft 0805HQ - 12NXJBB
L2	2.2nH IND, 0603	TOKO 0603 - LL1608FH2N2J
L3	3.9nH IND, 0603	TOKO 0603 - LL1608FH3N9J

Package Outline Drawing

(dimensions in mm)

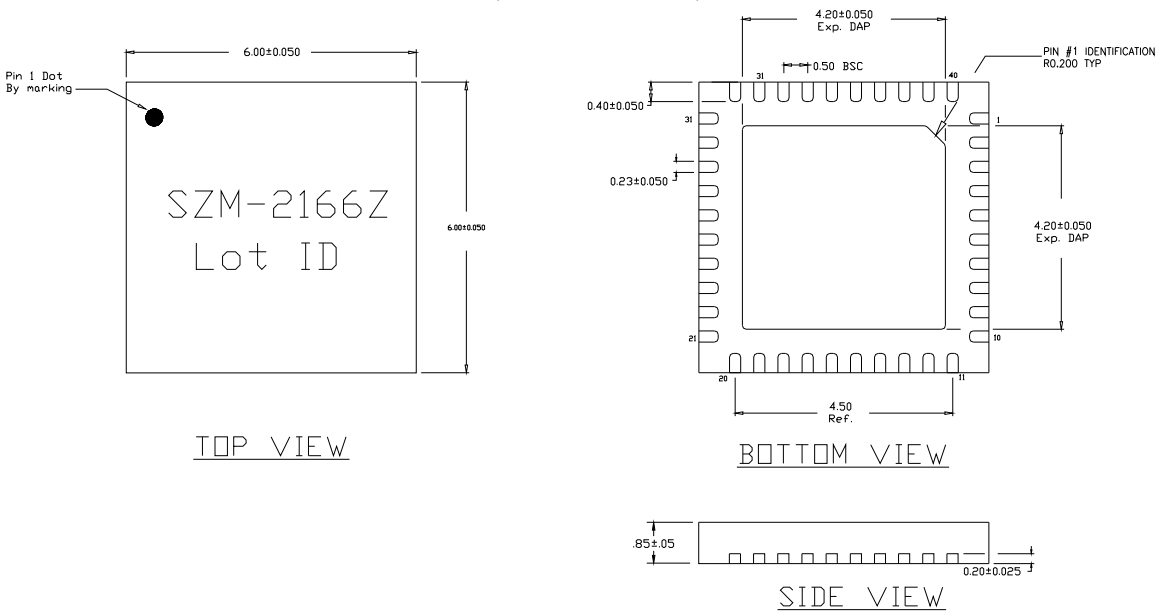

Metal Land Pattern and PCB Soldermask

Recommended Metal Land Pattern
(dimensions in mm[in]):

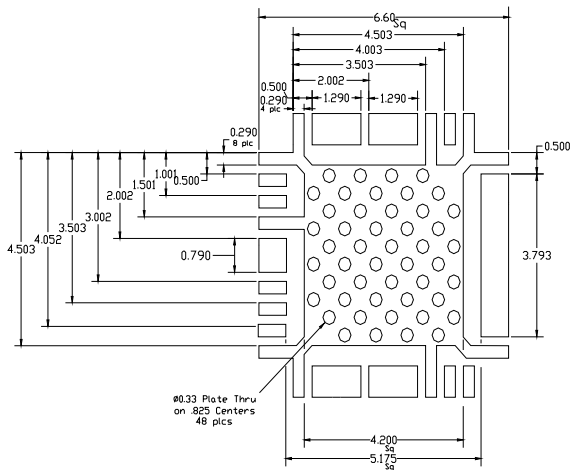

Recommended PCB Soldermask
for Land Pattern (dimensions in mm[in]):

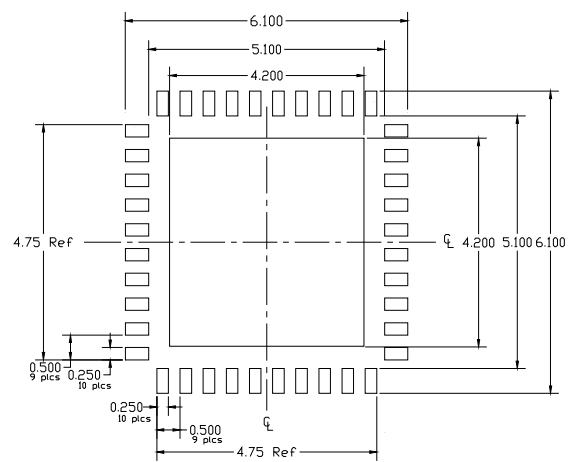

Ordering Information

Ordering Code	Description
SZM2166ZSQ	Standard 25 piece bag
SZM2166ZSR	Standard 100 piece reel
SZM2166Z	Standard 1000 piece reel
SZM2166ZPCK-EVB1	Evaluation Board 2.3GHz to 2.4 GHz Tune and 5 loose sample pieces
SZM2166ZPCK-EVB2	Evaluation Board 2.4GHz to 2.5GHz Tune and 5 loose sample pieces
SZM2166ZPCK-EVB3	Evaluation Board 2.5GHz to 2.7 GHz Tune and 5 loose sample pieces