

Supply Voltage: 1.8 to 3.6 V

- Typical sleep mode current < 0.1 μ A; retains state and RAM contents over full supply range; fast wakeup of < 2 μ s
- Two built-in brown-out detectors cover sleep and active modes

10-Bit Analog to Digital Converter

- Up to 300 ksp/s
- Up to 18 external inputs
- External pin or internal VREF (no external capacitor required)
- Built-in temperature sensor (± 3 $^{\circ}$ C); no calibration required
- External conversion start input option
- Autonomous burst mode with 16-bit automatic averaging accumulator

Dual Comparators

- Programmable hysteresis and response time
- Configurable as interrupt or reset source
- Low current (< 0.5 μ A)

Memory

- 32 kB flash; in-system programmable in 1024-byte sectors; full read/write/erase functionality over the entire supply range
- 4352 bytes internal data RAM (256 + 4K)

On-Chip Debug

- On-chip debug circuitry facilitates full speed, non-intrusive in-system debug (no emulator required)

High-Speed 8051 μ C Core

- Pipe-lined instruction architecture; executes 70% of instructions in 1 or 2 system clocks
- 25 MIPS peak throughput with 25 MHz clock

Development Kit: Si1000DK-915, Si1000DK-470, Si1002DK-868

Transceiver Features

- Frequency range = 240–960 MHz
- Sensitivity = -121 dBm
- FSK, GFSK, and OOK modulation
- Max output power = +20 dBm
- RF power consumption
 - 18.5 mA receive
 - 85 mA @ +20 dBm transmit
- Data rate = 0.123 to 256 kbps
- Auto-frequency calibration (AFC)
- Antenna diversity and transmit/receive switch control
- Programmable packet handler
- TX and RX 64 byte FIFOs
- Frequency hopping capability
- On-chip crystal tuning

Digital Peripherals

- 22 port I/O
- Hardware enhanced UART, SPI and I²C serial ports available concurrently
- Low power 32-bit smaRTClock
- Four general purpose 16-bit counter/timers; six channel programmable counter array (PCA)

Clock Sources

- Precision internal oscillators: 24.5 MHz with $\pm 2\%$ accuracy supports UART operation; spread-spectrum mode for reduced EMI
- Low power 20 MHz internal oscillator
- External oscillator: crystal, RC, C, CMOS clock
- smaRTClock oscillator: 32.768 kHz crystal or self-oscillate

Ordering Part Number

- Si1001-E-GM, 42-pin LGA (5 mm x 7 mm)

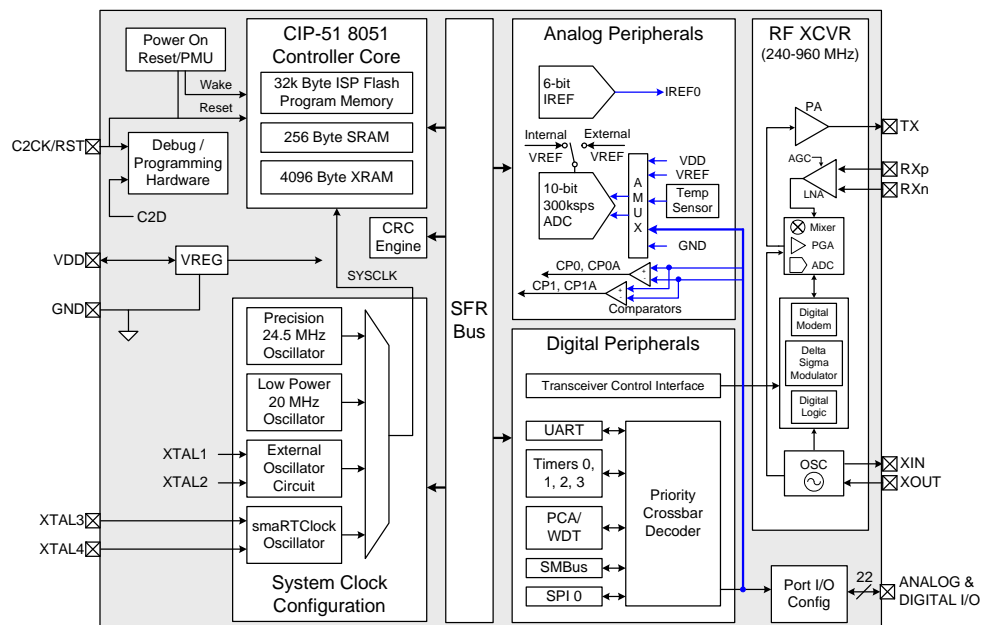



Smart.
Connected.
Energy-Friendly



Products
www.silabs.com/products



Quality
www.silabs.com/quality



Support and Community
community.silabs.com

Disclaimer

Silicon Laboratories intends to provide customers with the latest, accurate, and in-depth documentation of all peripherals and modules available for system and software implementers using or intending to use the Silicon Laboratories products. Characterization data, available modules and peripherals, memory sizes and memory addresses refer to each specific device, and "Typical" parameters provided can and do vary in different applications. Application examples described herein are for illustrative purposes only. Silicon Laboratories reserves the right to make changes without further notice and limitation to product information, specifications, and descriptions herein, and does not give warranties as to the accuracy or completeness of the included information. Silicon Laboratories shall have no liability for the consequences of use of the information supplied herein. This document does not imply or express copyright licenses granted hereunder to design or fabricate any integrated circuits. The products must not be used within any Life Support System without the specific written consent of Silicon Laboratories. A "Life Support System" is any product or system intended to support or sustain life and/or health, which, if it fails, can be reasonably expected to result in significant personal injury or death. Silicon Laboratories products are generally not intended for military applications. Silicon Laboratories products shall under no circumstances be used in weapons of mass destruction including (but not limited to) nuclear, biological or chemical weapons, or missiles capable of delivering such weapons.

Trademark Information

Silicon Laboratories Inc., Silicon Laboratories, Silicon Labs, SiLabs and the Silicon Labs logo, CMEMS®, EFM, EFM32, EFR, Energy Micro, Energy Micro logo and combinations thereof, "the world's most energy friendly microcontrollers", Ember®, EZLink®, EZMac®, EZRadio®, EZRadioPRO®, DSPLL®, ISOmodem®, Precision32®, ProSLIC®, SiPHY®, USBXpress® and others are trademarks or registered trademarks of Silicon Laboratories Inc. ARM, CORTEX, Cortex-M3 and THUMB are trademarks or registered trademarks of ARM Holdings. Keil is a registered trademark of ARM Limited. All other products or brand names mentioned herein are trademarks of their respective holders.



Silicon Laboratories Inc.
400 West Cesar Chavez
Austin, TX 78701
USA

<http://www.silabs.com>