

Dual Enhancement-Mode MOSFET (N- and P-Channel)

Product Summary

	V _{DS} (V)	r _{DS(on)} (Ω)	I _D (A)
N-Channel	25	0.10 @ V _{GS} = 10 V	± 3.5
		0.15 @ V _{GS} = 4.5 V	± 2.0
P-Channel	-25	0.25 @ V _{GS} = -10 V	± 2.3
		0.40 @ V _{GS} = -4.5 V	± 1.8

Recommended upgrade: Si4532DY, Si4539DY or Si9939DY

Lower profile/smaller size—see LITE FOOT® equivalent: Si6542DQ or Si6543DQ

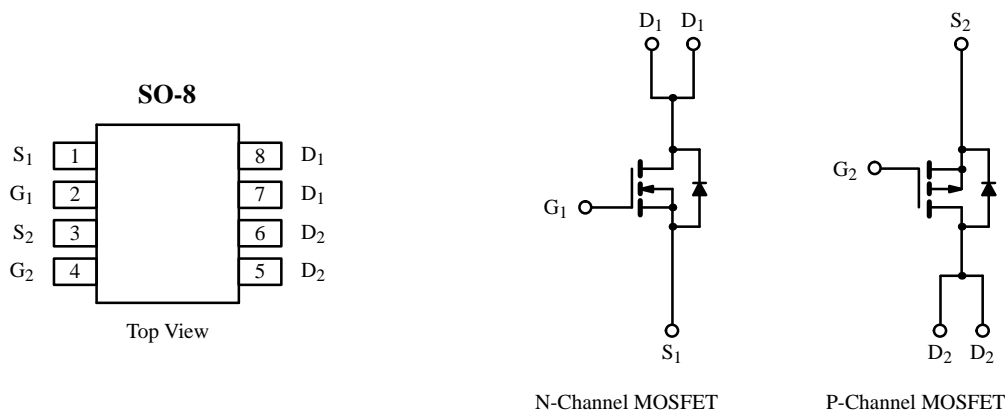

Absolute Maximum Ratings (T_A = 25° C Unless Otherwise Noted)

Parameter	Symbol	N-Channel	P-Channel	Unit
Drain-Source Voltage	V _{DS}	25	-25	V
Gate-Source Voltage	V _{GS}	± 20	± 20	
Continuous Drain Current (T _J = 150°C) ^a	I _D	T _A = 25°C	± 3.5	A
		T _A = 70°C	± 2.8	
Pulsed Drain Current	I _{DM}	± 14	± 9.2	
Continuous Source Current (Diode Conduction) ^a	I _S	1.7	-1.6	
Maximum Power Dissipation ^a	P _D	T _A = 25°C	2.0	W
		T _A = 70°C	1.3	
Operating Junction and Storage Temperature Range	T _J , T _{stg}	-55 to 150		°C

Thermal Resistance Ratings

Parameter	Symbol	N- or P-Channel	Unit
Maximum Junction-to-Ambient ^a	R _{thJA}	62.5	°C/W

Notes

a. Surface Mounted on FR4 Board, t ≤ 10 sec.

Subsequent updates to this data sheet may be obtained via facsimile by calling Siliconix FaxBack, 1-408-970-5600. Please request FaxBack document #1219. A SPICE Model data sheet is available for this product (FaxBack document #5111).

Specifications ($T_J = 25^\circ\text{C}$ Unless Otherwise Noted)

Parameter	Symbol	Test Condition	Min	Typ ^a	Max	Unit	
Static							
Gate Threshold Voltage	$V_{GS(th)}$	$V_{DS} = V_{GS}, I_D = 250\ \mu\text{A}$	N-Ch	1.0		V	
		$V_{DS} = V_{GS}, I_D = -250\ \mu\text{A}$	P-Ch	-1.0			
Gate-Body Leakage	I_{GSS}	$V_{DS} = 0\ \text{V}, V_{GS} = \pm 20\ \text{V}$			± 100	nA	
Zero Gate Voltage Drain Current	I_{DSS}	$V_{DS} = 20\ \text{V}, V_{GS} = 0\ \text{V}$	N-Ch		2	μA	
		$V_{DS} = -20\ \text{V}, V_{GS} = 0\ \text{V}$	P-Ch		-2		
		$V_{DS} = 20\ \text{V}, V_{GS} = 0\ \text{V}, T_J = 55^\circ\text{C}$	N-Ch		25		
		$V_{DS} = -20\ \text{V}, V_{GS} = 0\ \text{V}, T_J = 55^\circ\text{C}$	P-Ch		-25		
On-State Drain Current ^b	$I_{D(on)}$	$V_{DS} \geq 5\ \text{V}, V_{GS} = 10\ \text{V}$	N-Ch	3.5		A	
		$V_{DS} \leq -5\ \text{V}, V_{GS} = -10\ \text{V}$	P-Ch	-2.3			
Drain-Source On-State Resistance ^b	$r_{DS(on)}$	$V_{GS} = 10\ \text{V}, I_D = 1\ \text{A}$	N-Ch		0.08	0.10	Ω
		$V_{GS} = -10\ \text{V}, I_D = 1\ \text{A}$	P-Ch		0.13	0.25	
		$V_{GS} = 4.5\ \text{V}, I_D = 0.5\ \text{A}$	N-Ch		0.12	0.15	
		$V_{GS} = -4.5\ \text{V}, I_D = 0.5\ \text{A}$	P-Ch		0.20	0.40	
Forward Transconductance ^b	g_{fs}	$V_{DS} = 15\ \text{V}, I_D = 3.5\ \text{A}$	N-Ch		5.0	S	
		$V_{DS} = -15\ \text{V}, I_D = -3.5\ \text{A}$	P-Ch		3.2		
Diode Forward Voltage ^b	V_{SD}	$I_S = 1.25\ \text{A}, V_{GS} = 0\ \text{V}$	N-Ch		1.1	1.4	V
		$I_S = -1.25\ \text{A}, V_{GS} = 0\ \text{V}$	P-Ch		-1.2	-1.6	
Dynamic^a							
Total Gate Charge	Q_g	N-Channel $V_{DS} = 12.5\ \text{V}, V_{GS} = 10\ \text{V}, I_D = 2.3\ \text{A}$ P-Channel $V_{DS} = -12.5\ \text{V}, V_{GS} = -10\ \text{V}, I_D = -2.3\ \text{A}$	N-Ch		9.4	27	nC
Gate-Source Charge	Q_{gs}		N-Ch		1.6		
			P-Ch		1.3		
Gate-Drain Charge	Q_{gd}		N-Ch		3.1		
			P-Ch		3.0		
Turn-On Delay Time	$t_{d(on)}$		N-Channel $V_{DD} = 25\ \text{V}, R_L = 25\ \Omega$ $I_D \cong 1\ \text{A}, V_{GEN} = 10\ \text{V}, R_G = 6\ \Omega$ P-Channel $V_{DD} = -25\ \text{V}, R_L = 25\ \Omega$ $I_D \cong -1\ \text{A}, V_{GEN} = -10\ \text{V}, R_G = 6\ \Omega$	N-Ch		9	
Rise Time	t_r	N-Ch			8	20	
		P-Ch			19	40	
Turn-Off Delay Time	$t_{d(off)}$	N-Ch			45	90	
		P-Ch			42	90	
Fall Time	t_f	N-Ch			25	50	
		P-Ch			27	50	
Source-Drain Reverse Recovery Time	t_{rr}	$I_F = 1.25\ \text{A}, di/dt = 100\ \text{A}/\mu\text{s}$		N-Ch			75
			P-Ch		69	100	

Notes

- a. Guaranteed by design, not subject to production testing.
 b. Pulse test; pulse width $\leq 300\ \mu\text{s}$, duty cycle $\leq 2\%$.

Typical Characteristics (25°C Unless Otherwise Noted)

N-Channel

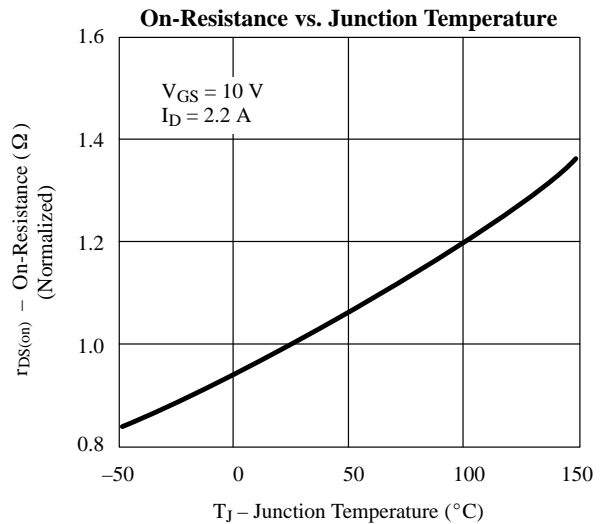
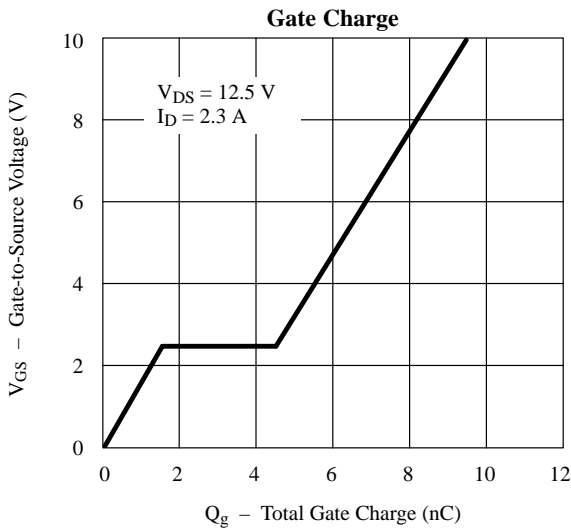
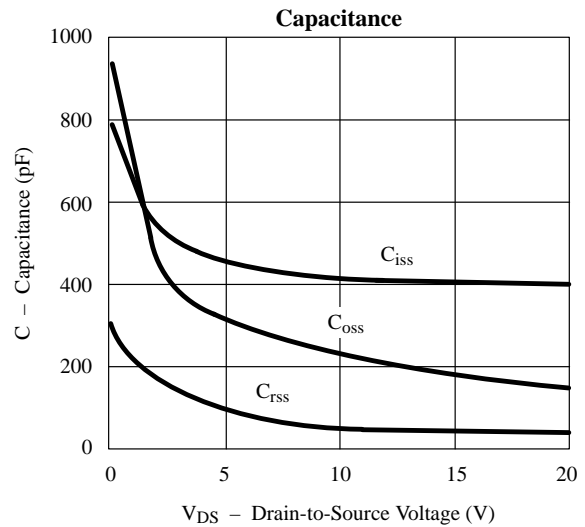
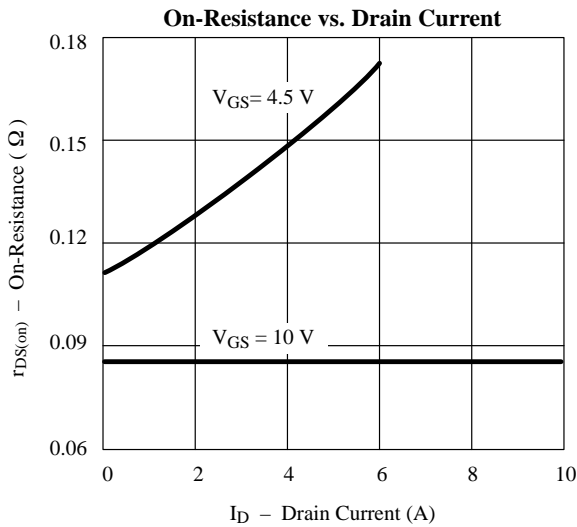
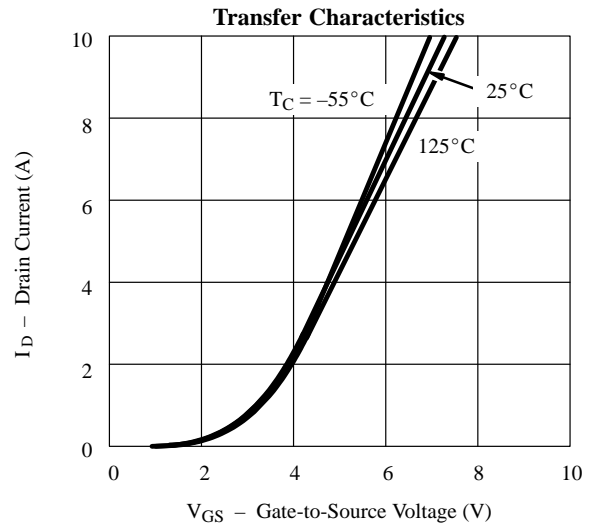
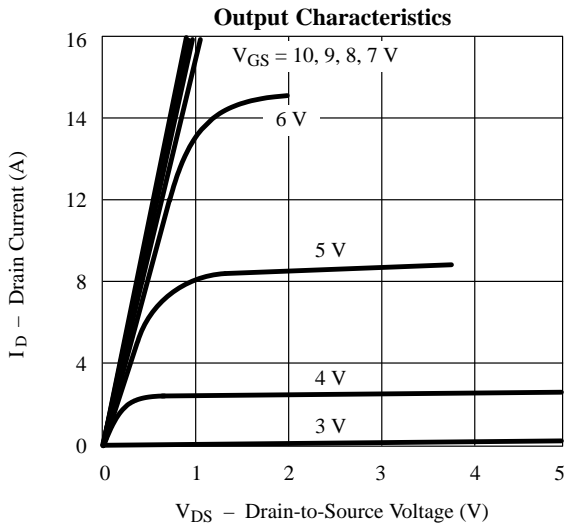

Typical Characteristics (25°C Unless Otherwise Noted)

N-Channel

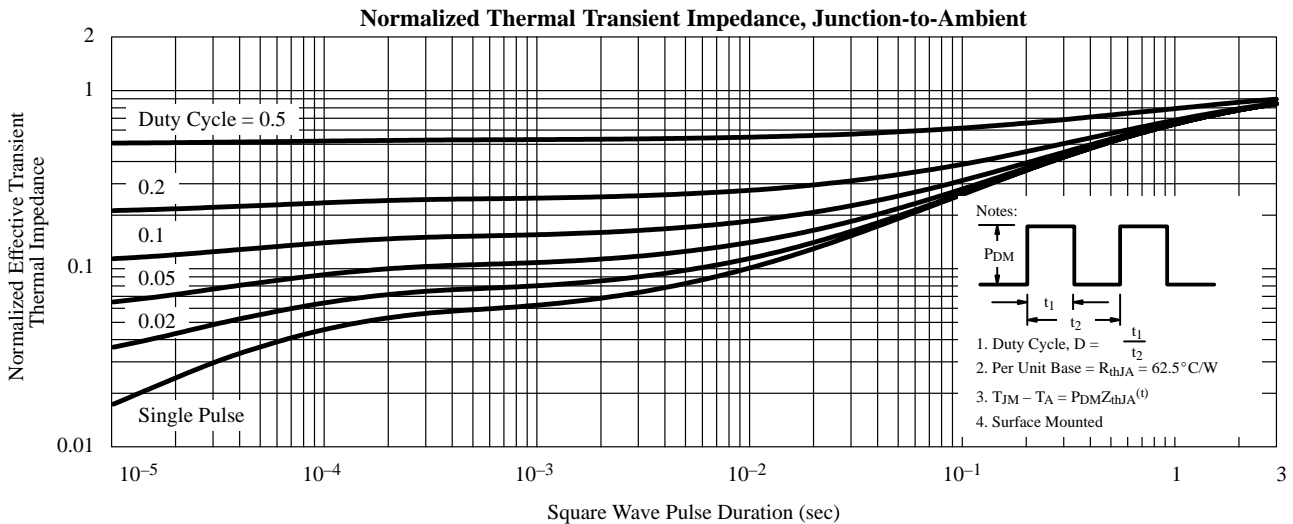
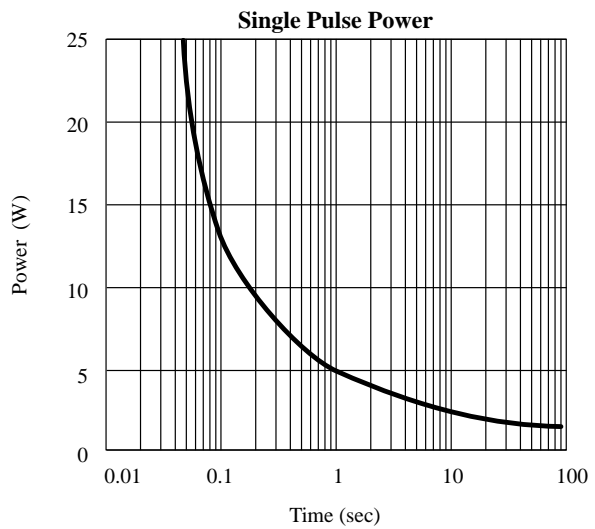
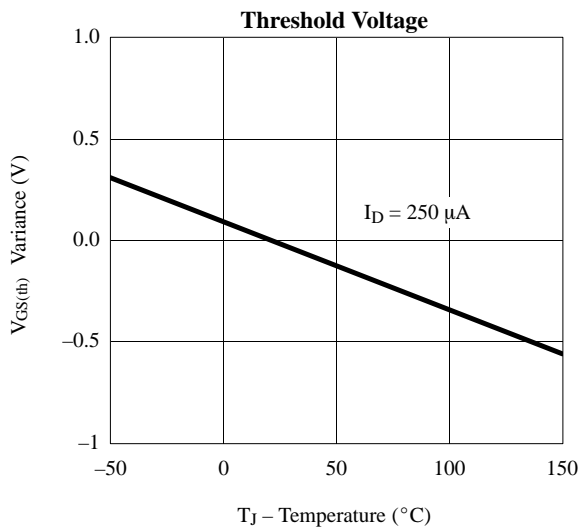
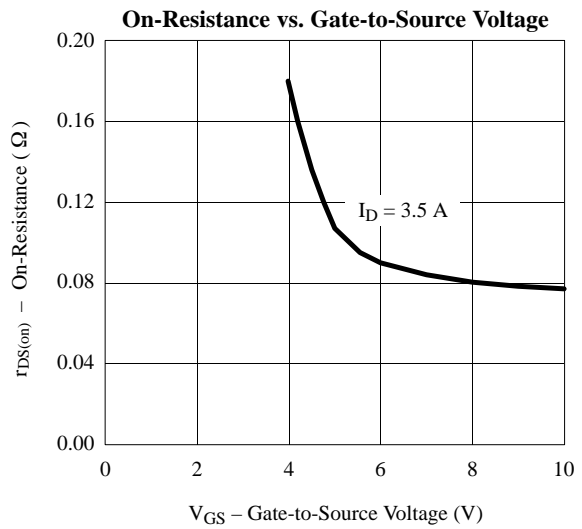
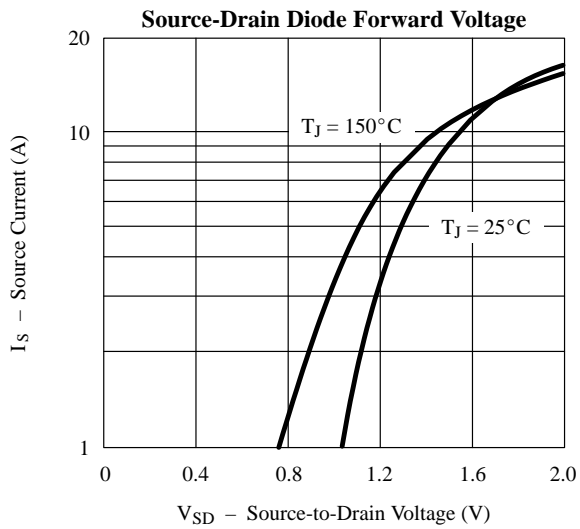

Typical Characteristics (25°C Unless Otherwise Noted)

P-Channel

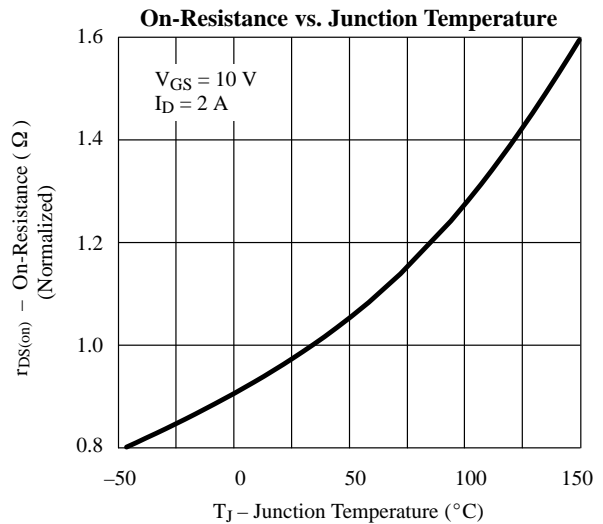
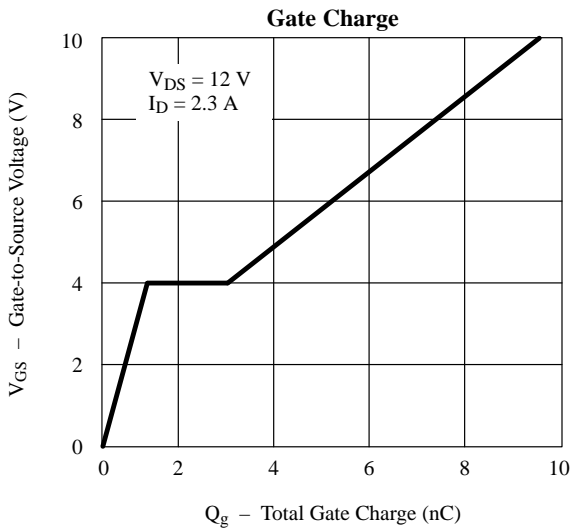
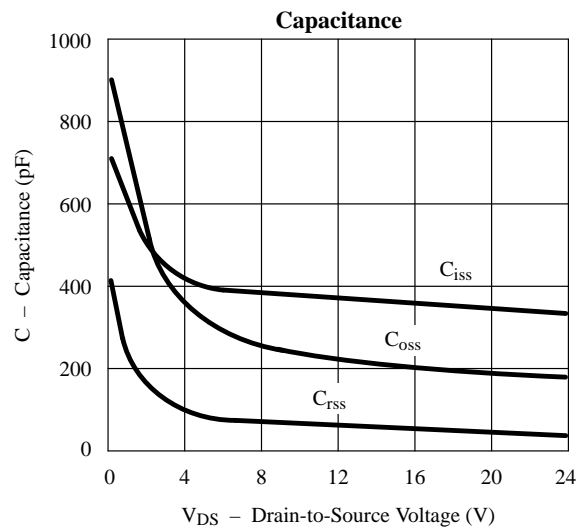
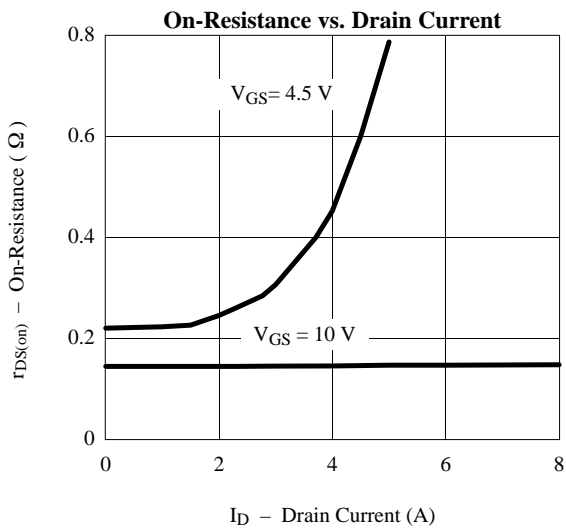
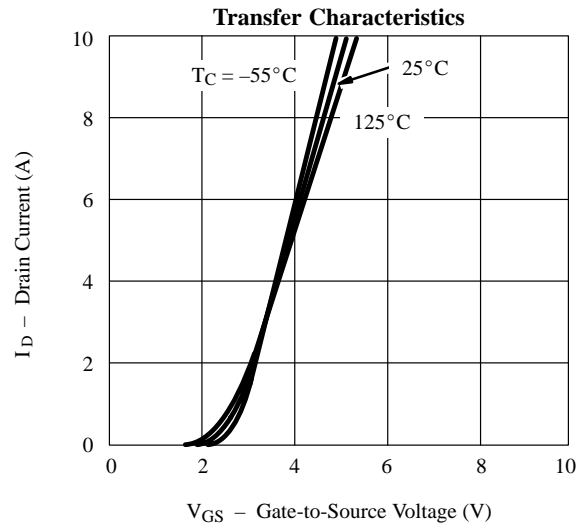
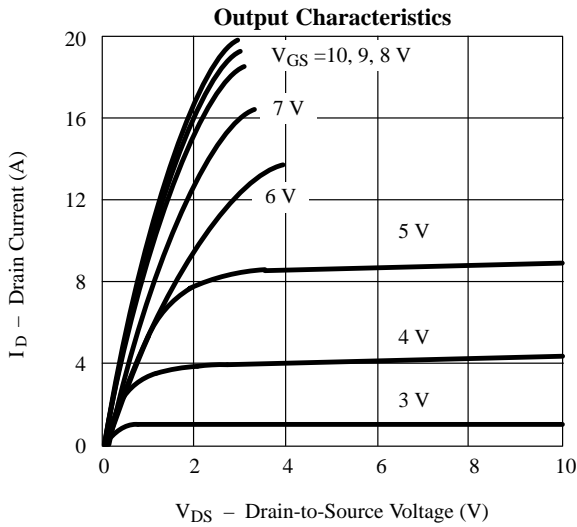

Typical Characteristics (25°C Unless Otherwise Noted)

P-Channel

