



LCD Module Technical Specification

First Edition

Mar. 28, 2002

Final Revision

T-51410D104-FW-P-AG

Checked by (Quality Assurance Div.)

*****The part number and specification are still tentative.**

Checked by (Design Engineering Div.)

Prepared by (Production Div.)

Table of Contents

1. Applications	2
2. Features	2
3. Mechanical Specifications	2
4. Mechanical Drawing TFT LCD Module	3
5. Input / Output Terminals	6
6. Absolute Maximum Ratings	7
7. Electrical Characteristics	7
8. Power Sequence	13
9. Optical Characteristics	14
10. Reliability TEST	17
11. Block Diagram	18

Revision History

Rev.	Date	Page	Comment

1.Application

This data sheet applies to a color TFT LCD module.

Module applies to OA product, car TV(must use Analog to Digital drive board), which require high quality flat panel display. If you must use in high reliability environment can't over reliability test condition

Optrex assumes no responsibility for any damage resulting from the use of the device which dose not comply with the instructions and the precautions inthese specification sheet.

2. Features

- . Amorphous silicon TFT LCD panel with back-light unit
- . Pixel in stripe configuration
- . Slim and compact, designed for O/A application
- . Display Colors: 262,144 colors
- . Optimum Viewing Direction: 12 o'clock
- . 3.3V LVDS interface standard: DS90CF364 as receiver
- . +3.3V DC supply voltage for TFT LCD panel driving
- . Backlight driving DC/AC inverter not included in this module
- . Wide Viewing Angle

3.Mechanical Specifications

Parameter	Specifications	Unit
Screen Size	26.4(diagonal)	cm
	10.4 (diagonal)	inch
Display Format	800 × (R, G, B) × 600	dot
Display Colors	262,144	
Active Area	211.2(H) × 158.4 (V)	mm
Pixel Pitch	0.264 (H) × 0.264 (V)	mm
Pixel Configuration	Stripe	
Outline Dimension	243 (w) × 185.1(H) × 11(typ.) (D)	mm
Weight	470(typ.),	g
Back-light	CCFL, 2 tubes	
Surface treatment	Anti-glare and hard-coating	
Display mode	Normally white	

OUTLINE DRAWING: Rear View (Unit : mm)

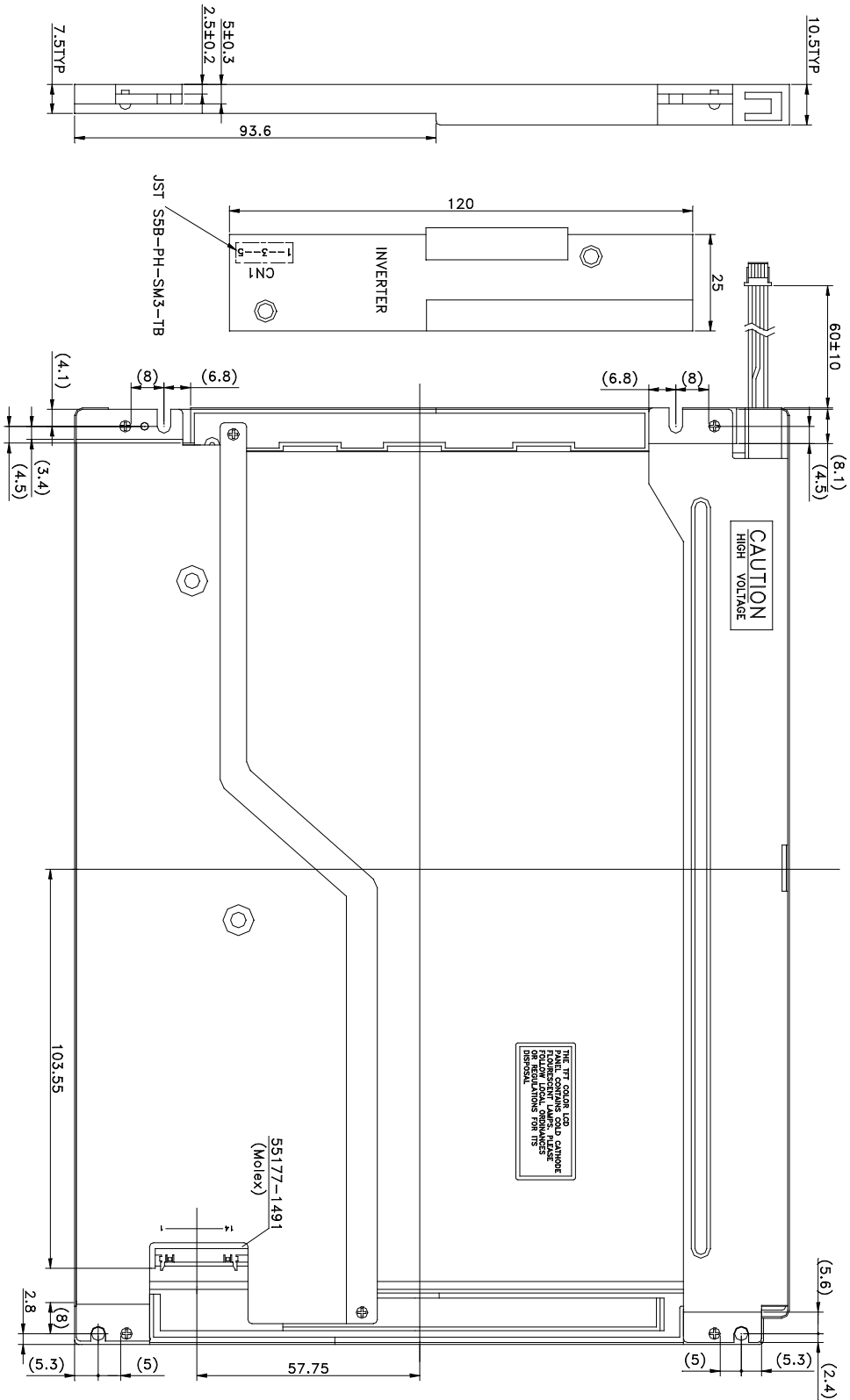

5. Input Terminals

5-1) TFT-LCD Panel Driving

Connector type: Molex 55177-1491

Pin No.	Symbol	Function	Remark
1	VDD	Power supply : +3.3V	
2	VDD	Power supply : +3.3V	
3	GND		
4	GND		
5	IN0-	Pixel data Transmission pair 0 (negative -)	
6	IN0+	Pixel data Transmission pair 0 (positive +)	
7	IN1-	Pixel data Transmission pair 1 (negative -)	
8	IN1+	Pixel data Transmission pair 1 (positive +)	
9	IN2-	Pixel data Transmission pair 2 (negative -)	
10	IN2+	Pixel data Transmission pair 2 (positive +)	
11	CLK-	Sampling Clock (negative -)	
12	CLK+	Sampling Clock (positive +)	
13	GND		
14	GND		

Recommended Transmitter (DS90C*363 of National Semiconductor) to interface Assignment:

Input terminal of DS 90C*363		Graphic controller output signal		Output signal symbol	To interface terminal(Symbol)
Symbol	No.	Symbol	Function		
TIN0	44	R0	Red pixel data (LSB)		No.5 : IN0- No.6 : IN0+
TIN1	45	R1	Red pixel data		
TIN2	47	R2	Red pixel data		
TIN3	48	R3	Red pixel data		
TIN4	1	R4	Red pixel data		
TIN5	3	R5	Red pixel data(MSB)		
TIN6	4	G0	Green pixel data (LSB)		No.7 : IN1- No.8 : IN1+
TIN7	6	G1	Green pixel data		
TIN8	7	G2	Green pixel data		
TIN9	9	G3	Green pixel data		
TIN10	10	G4	Green pixel data		
TIN11	12	G5	Green pixel data(MSB)		
TIN12	13	B0	Blue pixel data(LSB)		No.9 : IN2- No.10 : IN2+
TIN13	15	B1	Blue pixel data		
TIN14	16	B2	Blue pixel data		
TIN15	18	B3	Blue pixel data		
TIN16	19	B4	Blue pixel data		
TIN17	20	B5	Blue pixel data(MSB)		
TIN18	22	NC	No connection		No.9 : IN2- No.10 : IN2+
TIN19	23	NC	No connection		
TIN20	25	ENAB	Compound Synchronization signal		
CLK in	26	NCLK	Data sampling clock	TCLK out- TCLK out+	No.11 : CLK IN- No.12 : CLK IN+

Data stream of IN0-/+, IN1-/+, and IN2-/+

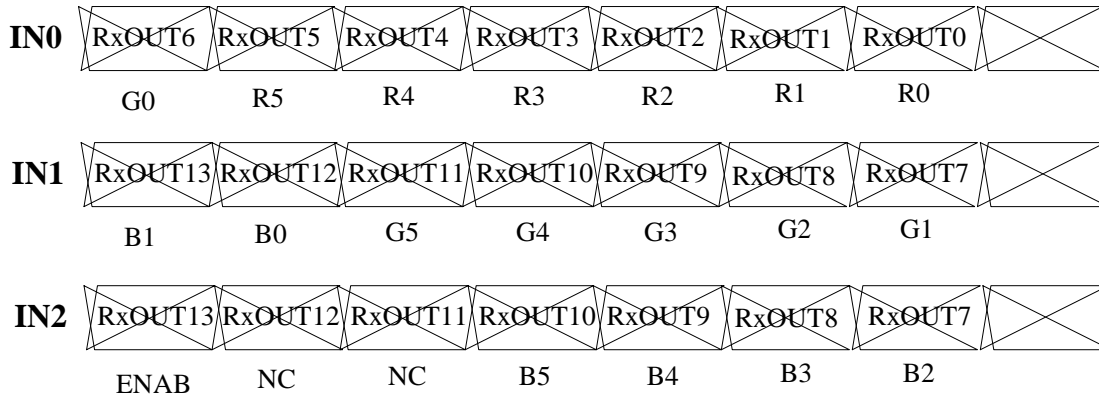

LVDS Interface Block Diagram

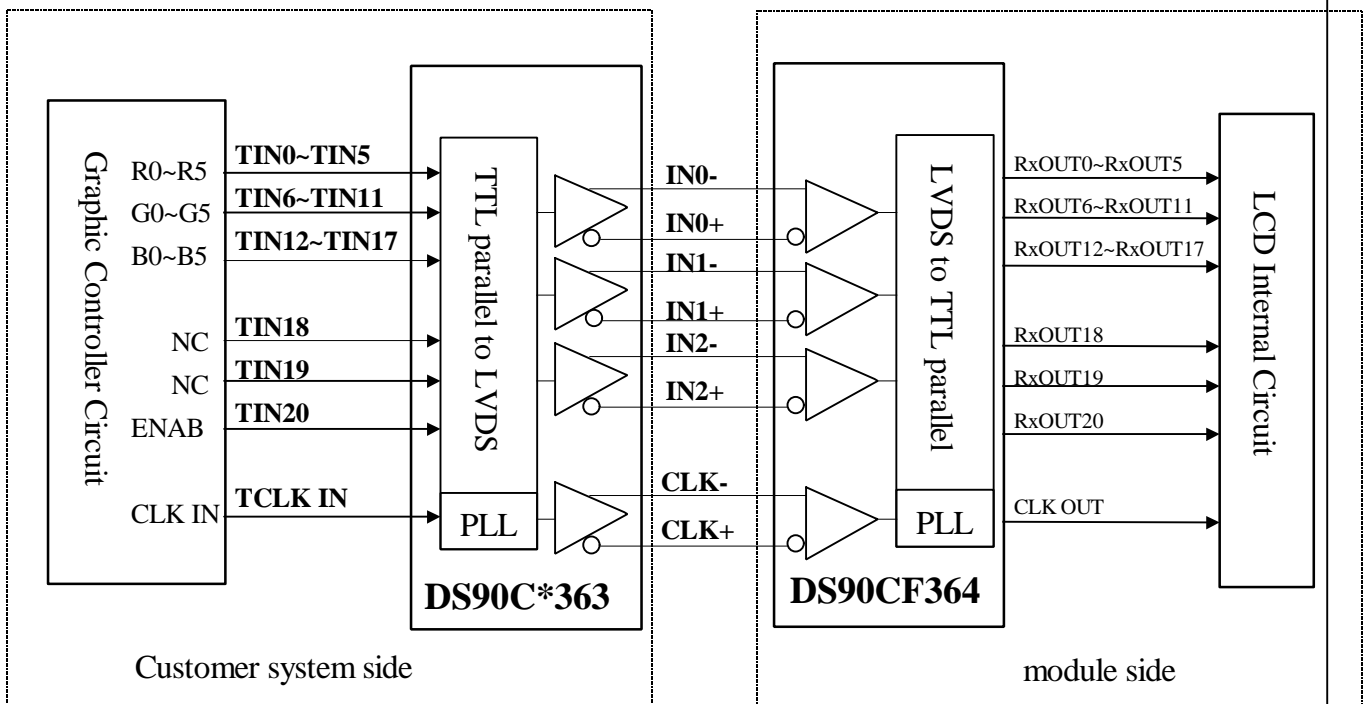

5-2) Backlight driving

Connector type : "BHR-02VS-1" of Japan Solderless Terminal MFG Co. LTD

PIN NO.	Symbol	Description	Remark
1	LV	Ground	White
2	HV	Lamp power input	Pink (or Gray)
3	HV	Lamp power input	Pink (or Gray)

6. Absolute Maximum Ratings:

GND=0V, Ta=25

Parameters	Symbol	MIN.	MAX.	Unit	Remark
Supply Voltage	V _{DD}	-0.3	+4.0	V	
Input Signals Voltage	V _{IN}	-0.3	VDD+0.3	V	Note 6-1
Backlight Driving Voltage	V _L	-	2000	V	
Backlight Driving Frequency	F _L	0	100	KHz	
Storage Temperature	T _{ST}	-20	+60		Note 6-2
Operating Temperature	T _{OP}	0	+50		

Note 6-1: LVDS signal

Note 6-2: Humidity : 80% RH Max. at Ta ≤ 40 .

Maximum wet-bulb temperature is at 39 or less at Ta > 40 and no condensation.

7. Electrical Characteristics

7-1) Recommended Operating Conditions:

GND = 0V, Ta = 25

Item	Symbol	Min.	Typ.	Max.	Unit	Remark
Supply Voltage	VDD	3.0	3.3	3.6	V	
Current Dissipation	I _{DD}	-	370	430	mA	Note 7-1
LVDS Differential input high threshold	V _{TH}	-	-	100	mV	Note 7-2
LVDS Differential input low threshold	V _{TL}	-100	-	-		
Lamp Current	I _{FL}	6.0	14.0	16.0	mA	Note 7-3 Note 7-5
Lamp Voltage	V _L	400	430	530	Vrms	Note 7-3
Lamp Initial Voltage	V _{SFL}	-	-	875	Vrms	at Ta=25°C Note 7-4
		-	-	1300		at Ta=0°C Note 7-4
Lamp Driving Frequency	F _L	30	55	60	KHz	
Lamp power consumption		4	8	11	W	Note 7-5
Lamp Life Time		30000	40000		Hrs	Note 7-6
LCD Panel Life Time(MTBF)			50000		Hrs	

Note 7-1 : To test the current dissipation of VDD, using the “color bars” testing pattern shown as below

1	2	3	4	5	6	7	8
---	---	---	---	---	---	---	---

1. White
2. Yellow
3. Cyan
4. Green
5. Magenta
6. Red
7. Blue
8. Black

Idd current dissipation testing pattern

Note 7-2 : Please refers to DS90CF364 specification by National Semiconductor Corporation.

This LCD module conforms to LVDS standard.

Note 7-3 : The back-light driving waveform should be as closed to sine-wave as possible.

In order to satisfy the quality of B/L , no matter use what kind of inverter , the output lamp current must between Min. and Max. to avoid the abnormal display image caused by B/L.

Note 7-4 : Not including the efficiency of backlight DC/AC inverter

Note 7-5 : Lamp current is measured with current meter for high frequency as shown below

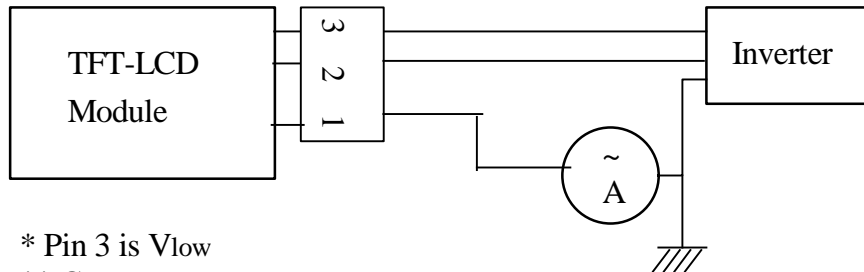

* Pin 3 is Vlow

** Current meter :

Yokogawa 2016-01

Lamp current dissipation testing configuration

Note 7-6: The life time is determined as the time at which brightness of lamp is 50% compare

to that of initial value at the typical lamp current.

7-2) Input / Output signal timing chart

(A) Vertical Timing

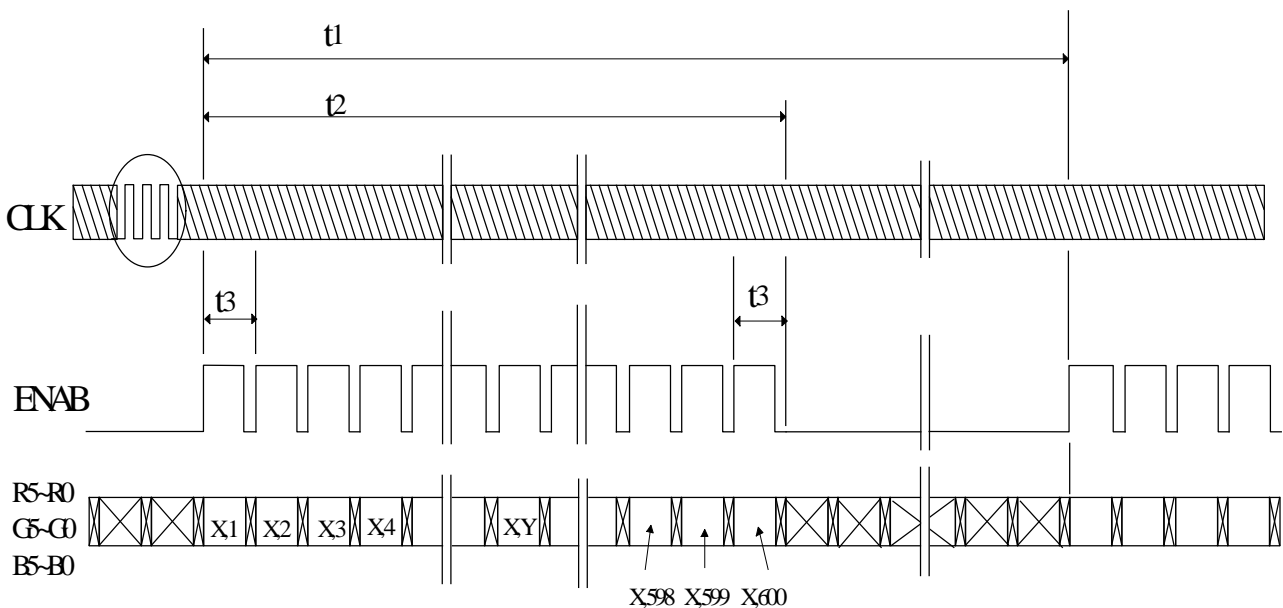

(B) Horizontal Timing

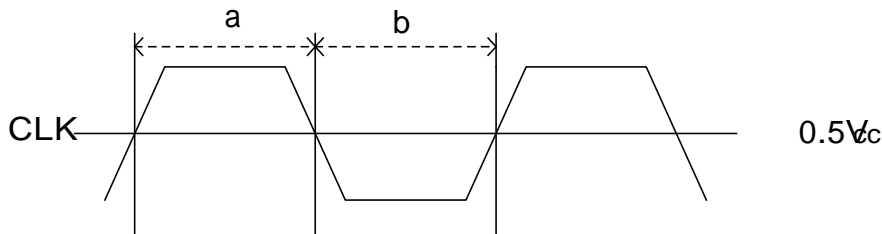
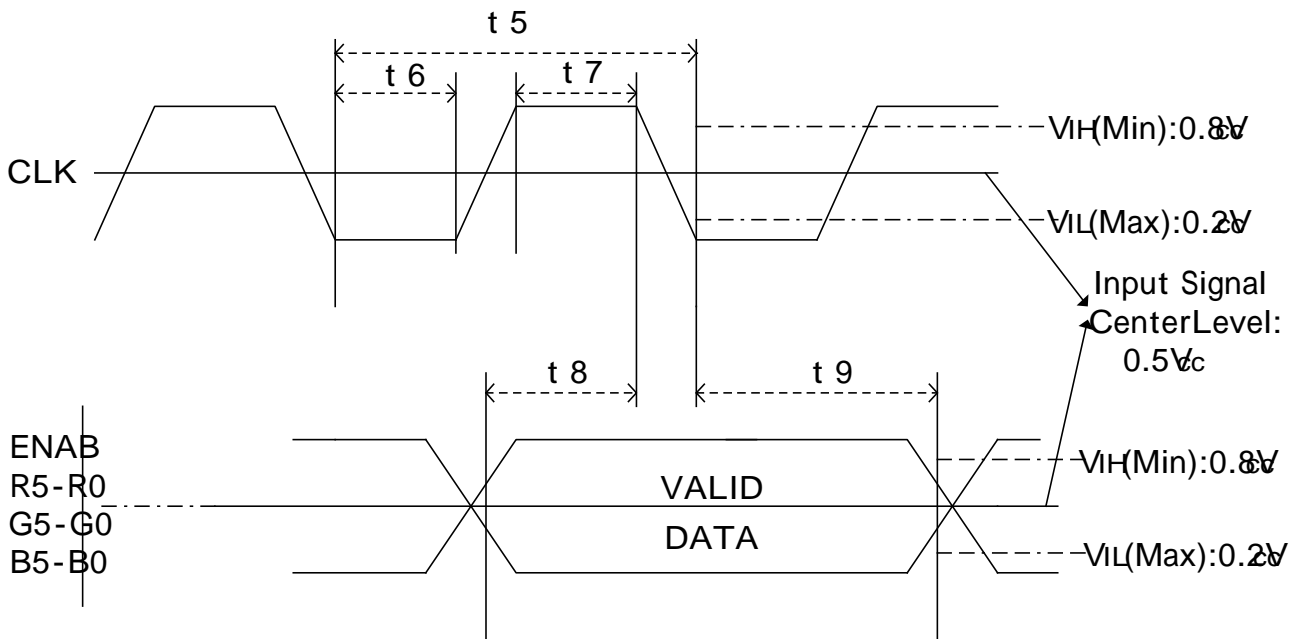
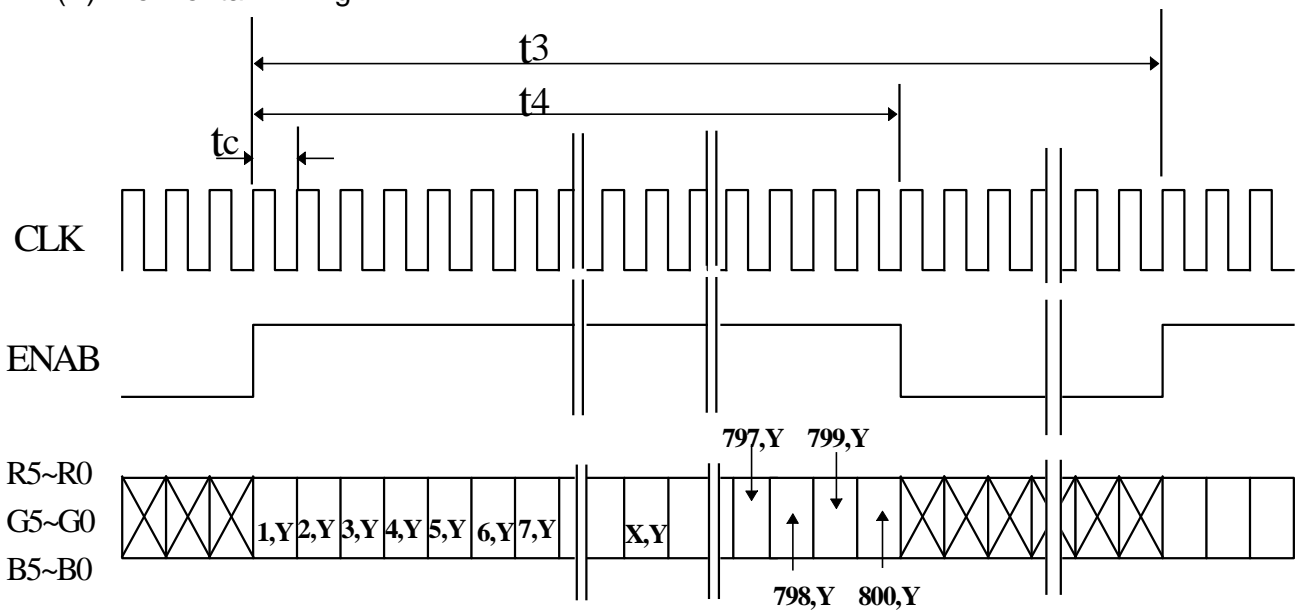

Duty (a , b) : 50 . ± 10%

D) Timing Specifications

Item	Symbol	Min.	Typ.	Max.	Unit	Remark
Frame Cycling	t1	604 X t3	628X t3	660 X t3	-	
		-	16.58	17.86	ms	
Vertical Display Period	t2	600 X t3	600 X t3	600 X t3	-	
Horizontal Scanning Time	t3	844 X t5	1056 X t5	1064 X t5	-	
		26.3	26.4	-	μs	
Horizontal Display Period	t4	-	800 X t5	-	-	
Clock Cycle	t5	24.0	25.0	-	ns	
Clock High Level Time	t6	9.0	-	-	ns	
Clock Low Level Time	t7	9.0	-	-	ns	
Hold time	t8	4.0	-	-	ns	
Set-up time	t9	5.0	-	-	ns	

7-3) Display Color and Gray Scale Reference

Color		Input Color Data																	
		Red						Green						Blue					
		R5	R4	R3	R2	R1	R0	G5	G4	G3	G2	G1	G0	B5	B4	B3	B2	B1	B0
Basic Colors	Black	0	0	0	0	0	0	0	0	0	0	0	0	0	0	0	0	0	0
	Red (63)	1	1	1	1	1	1	0	0	0	0	0	0	0	0	0	0	0	0
	Green (63)	0	0	0	0	0	0	1	1	1	1	1	1	0	0	0	0	0	0
	Blue (63)	0	0	0	0	0	0	0	0	0	0	0	0	1	1	1	1	1	1
	Cyan	0	0	0	0	0	0	1	1	1	1	1	1	1	1	1	1	1	1
	Magenta	1	1	1	1	1	1	0	0	0	0	0	0	1	1	1	1	1	1
	Yellow	1	1	1	1	1	1	1	1	1	1	1	1	0	0	0	0	0	0
	White	1	1	1	1	1	1	1	1	1	1	1	1	1	1	1	1	1	1
Red	Red (00)	0	0	0	0	0	0	0	0	0	0	0	0	0	0	0	0	0	0
	Red (01)	0	0	0	0	0	1	0	0	0	0	0	0	0	0	0	0	0	0
	Red (02)	0	0	0	0	1	0	0	0	0	0	0	0	0	0	0	0	0	0
	Darker																		
	Brighter																		
	Red (61)	1	1	1	1	0	1	0	0	0	0	0	0	0	0	0	0	0	0
	Red (62)	1	1	1	1	1	0	0	0	0	0	0	0	0	0	0	0	0	0
	Red (63)	1	1	1	1	1	1	0	0	0	0	0	0	0	0	0	0	0	0
Green	Green (00)	0	0	0	0	0	0	0	0	0	0	0	0	0	0	0	0	0	0
	Green (01)	0	0	0	0	0	0	0	0	0	0	0	1	0	0	0	0	0	0
	Green (02)	0	0	0	0	0	0	0	0	0	0	1	0	0	0	0	0	0	0
	Darker																		
	Brighter																		
	Green (61)	0	0	0	0	0	0	1	1	1	1	0	1	0	0	0	0	0	0
	Green (62)	0	0	0	0	0	0	1	1	1	1	1	0	0	0	0	0	0	0
	Green (63)	0	0	0	0	0	0	1	1	1	1	1	1	0	0	0	0	0	0
Blue	Blue (00)	0	0	0	0	0	0	0	0	0	0	0	0	0	0	0	0	0	0
	Blue (01)	0	0	0	0	0	0	0	0	0	0	0	0	0	0	0	0	0	1
	Blue (02)	0	0	0	0	0	0	0	0	0	0	0	0	0	0	0	0	1	0
	Darker																		
	Brighter																		
	Blue (61)	0	0	0	0	0	0	0	0	0	0	0	0	1	1	1	1	0	1
	Blue (62)	0	0	0	0	0	0	0	0	0	0	0	0	1	1	1	1	1	0
	Blue (63)	0	0	0	0	0	0	0	0	0	0	0	0	1	1	1	1	1	1

7-4) Pixel Arrangement

The LCD module pixel arrangement is the stripe.

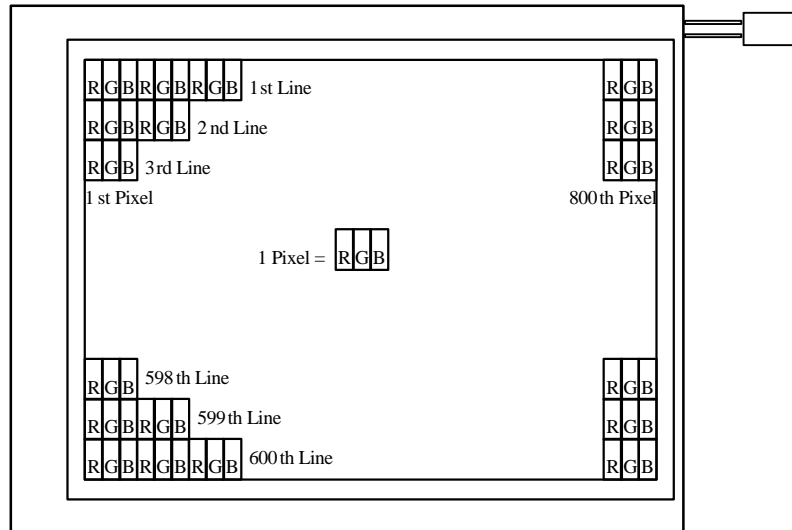

8.) Power On Sequence

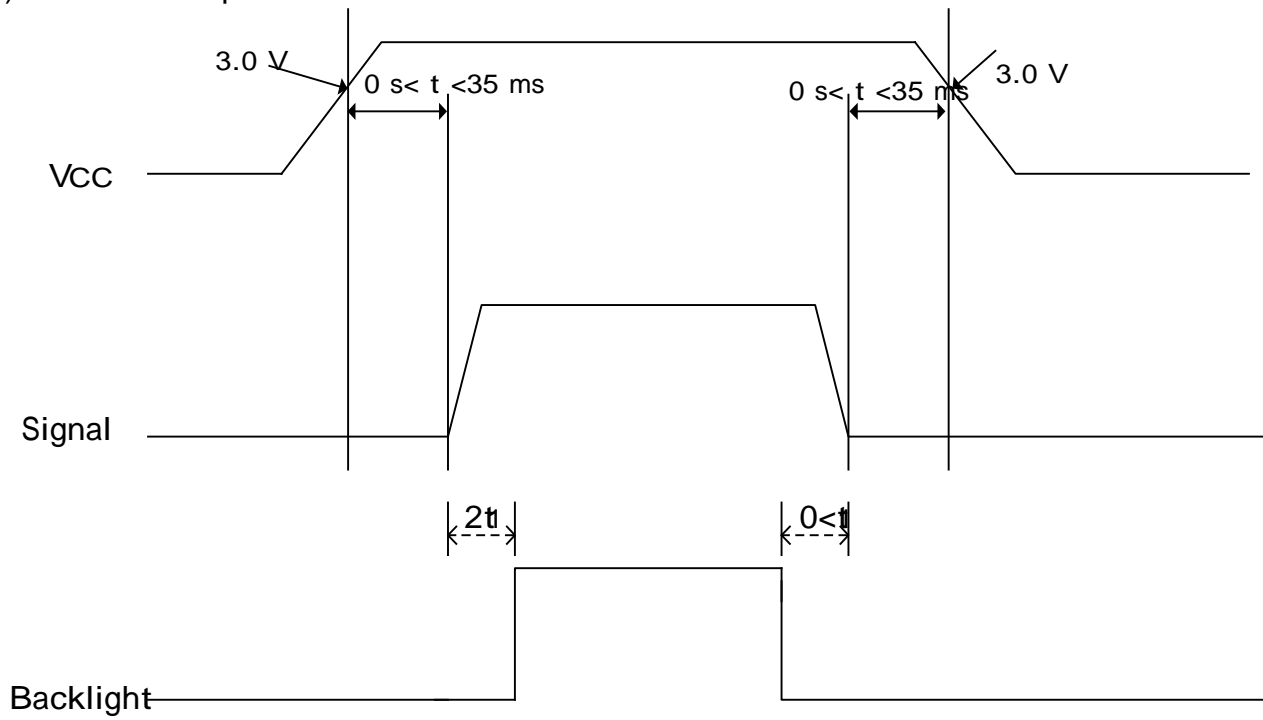

1. The supply voltage for input signals should be same as V_{CC} .
2. When the power is off , please keep whole signals (Hsync, Vsync, CLK, Data) low level or high impedance

9.) Optical Characteristics

9-1) Specification:

Ta = 25

Parameter		Symbol	Condition	MIN.	TYP.	MAX.	Unit	Remarks
Viewing Angle	Horizontal		CR≥10	± 55	± 60	-	deg	Note 9-1
	Vertical	(to 12 o'clock)		50	55	-	deg	
		(to 6 o'clock)		35	40	-	deg	
Contrast Ratio		CR	Optimum direction	100	180	-	-	Note 9-2
Response time	Rise	Tr	=0°	-	15	50	ms	Note 9-4
	Fall	Tf	=0°	-	25	50	ms	
Luminance		L	=0°/ =0°	310	350	-	cd/m ²	Note 9-3
Luminance Uniformity		U		55	80	-	%	Note 9-5
White Chromaticity		x		0.280	0.330	0.380	-	
		y		0.340	0.390	0.440	-	
Cross Talk Ratio		CTK		-	-	3.5	%	Note 9-6

All the optical measurement shall be executed 30 minutes after backlight being turn-on. The optical characteristics shall be measured in dark room (ambient illumination on panel surface less than 1 Lux). The measuring configuration shows as following figure.

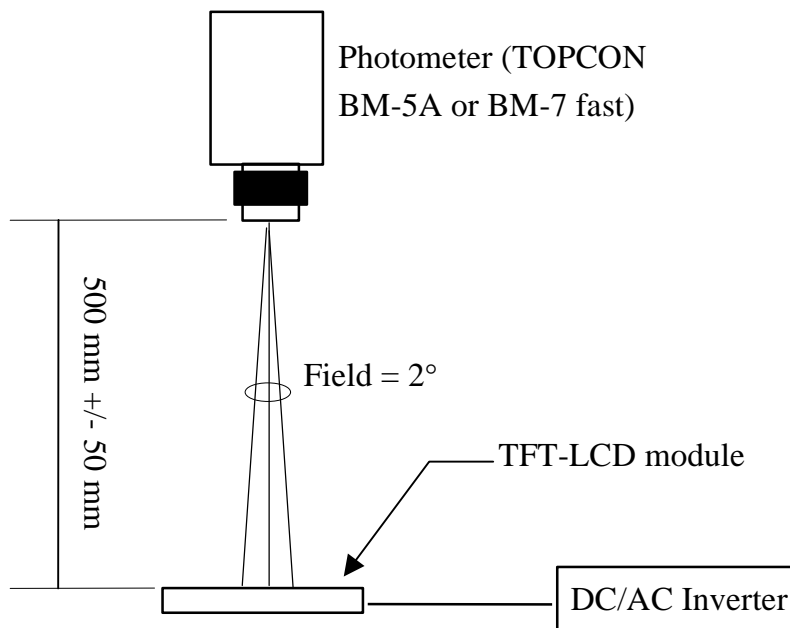

Optical characteristics measuring configuration

Note 9-1` : The definitions of viewing angles are as follows.

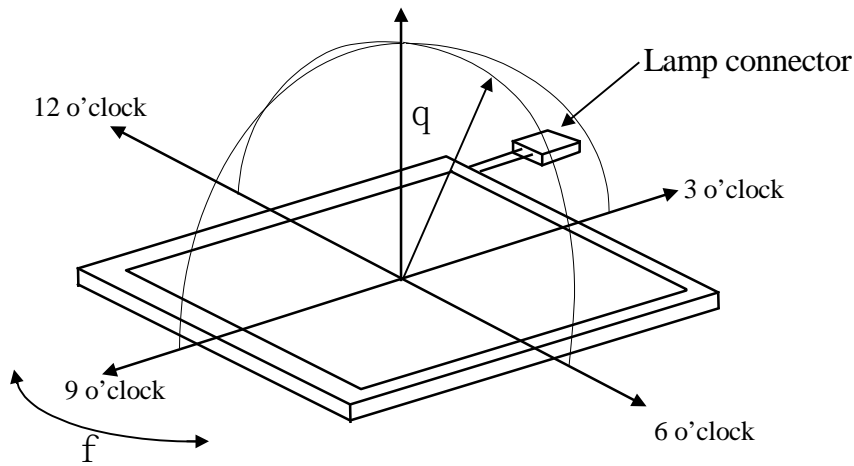

Note 9-2 : The definition of contrast ratio $CR = \frac{\text{Luminance at gray level 63}}{\text{Luminance at gray level 0}}$

Note 9-3 : Topcon BM-5A luminance meter 2° field of view is used in the testing (after 30 minutes' operation). The typical luminance value is measured at lamp current 14.0 mA.

Note 9-4: Definition of Response Time T_r and T_f :

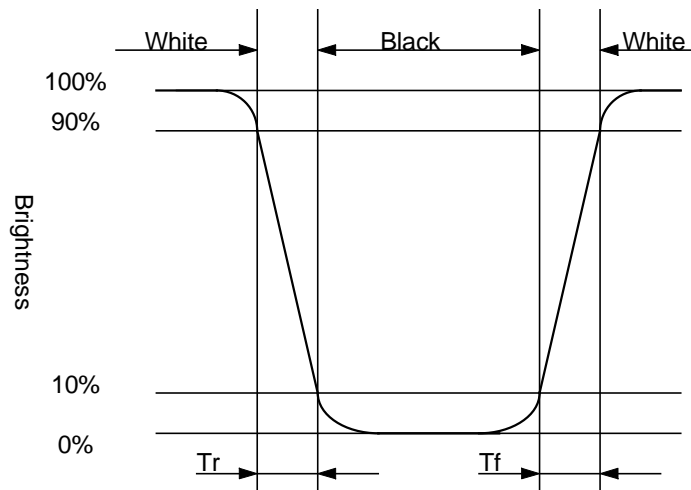

Note 9-5: The uniformity of LCD is defined as

$$U = \frac{\text{The Minimum Brightness of the 9 testing Points}}{\text{The Maximum Brightness of the 9 testing Points}}$$

Luminance meter : BM-5A or BM-7 fast(TOPCON)

Measurement distance : 500 mm +/- 50 mm

Ambient illumination : < 1 Lux

Measuring direction : Perpendicular to the surface of module

The test pattern is white (Gray Level 63).

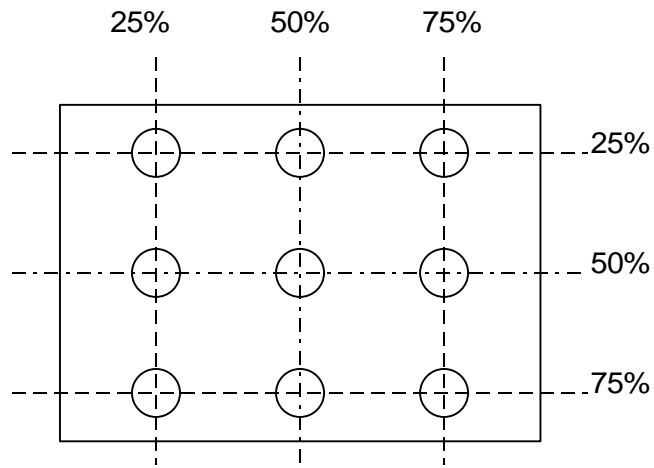

Note 8-6: Cross Talk (CTK) = $\frac{|YA-YB|}{YA} \times 100\%$

YA: Brightness of Pattern A

YB: Brightness of Pattern B

Luminance meter : BM 5A (TOPCON)

Measurement distance : 500 mm +/- 50 mm

Ambient illumination : < 1 Lux

Measuring direction : Perpendicular to the surface of module

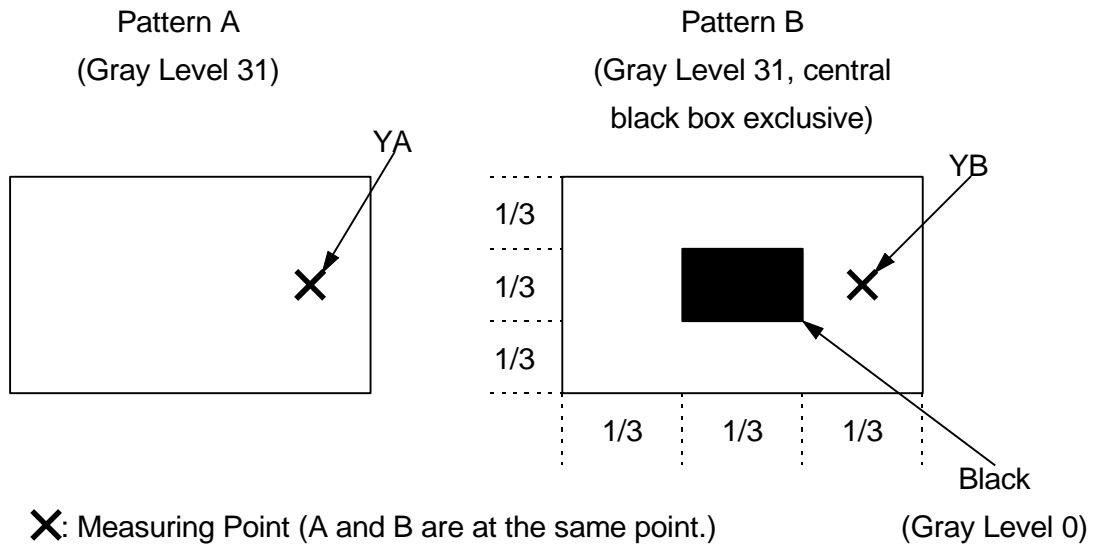

10. Reliability Test

No	Test Item	Test Condition	Remark
1	High Temperature Storage Test	Ta = +60 , 240 hrs	
2	Low Temperature Storage Test	Ta = -20 , 240 hrs	
3	Low Temperature Operation Test	Ta = 0 , 240 hrs	
4	High Temperature & High Humidity Operation Test	Ta = +50 , 80%RH, 240 hrs (No Condensation)	
5	Thermal Cycling Test (non-operating)	0 → +25 → +60 , 50 Cycles 1Hr 0.5Hr 1Hr	
6	Vibration Test (non-operating)	Frequency: 10 ~ 57 Hz, Amplitude: 0.15 mm 58~500Hz, 1G Sweep time: 11 min Test Period: 3 hrs (1 hr for each direction of X, Y, Z)	
7	Shock Test (non-operating)	80G, 6ms, X,Y, Z 1 times for each direction	

Ta: ambient temperature

[Judgement Criteria]

Under the display quality test conditions with normal operation state , there should be no change which may affect practical display function.

11.)Block Diagram

