

LCD Module Technical Specification

Type No. **T-51513D104J-FW-A-AJN**



Approved by (Quality Assurance Division)



Checked by (ACI Engineering Division)



Prepared by (ACI Engineering Division)

No.	Item	Page
--	CONTENTS	1
1	APPLICATION	2
2	OVERVIEW	3
3	ABSOLUTE MAXIMUM RATINGS	4
4	ELECTRICAL CHARACTERISTICS	4
5	INTERFACE PIN CONNECTION	7
6	INTERFACE TIMING	8
7	BLOCK DIAGRAM	12
8	MECHANICAL SPECIFICATION	13
9	OPTICAL CHARACTERISTICS	15
10	RELIABILITY TEST CONDITION	18
11	INSPECTION STANDARDS	19
12	OTHER FEATURE	20
13	HANDLING PRECAUTIONS FOR TFT-LCD MODULE	21
--	PACKAGING SPECIFICATION	24
--	PRODUCTS NUMBER LABELING FORMS	27
--	LAMP UNIT for 10.4" VGA	29

1. APPLICATION

This specification applies to color TFT-LCD module, T-51513D104J-FW-A-AJN.

These specification papers are the proprietary product of OPTREX and include materials protected under copyright of OPTREX. No part of this document may be reproduced in any form or by any means without the express written permission of OPTREX.

OPTREX does not assume any liability for infringement of patents, copyrights or other intellectual property rights of third parties by or arising from use of a product specified in this document. No license, express, implied or otherwise, is granted under any patents, copyrights or other intellectual property rights of OPTREX or of others.

OPTREX classifies the usage of the TFT-LCD module as follows. Please confirm the usage before using the product.

(1) Standard Usage

Computers, office equipment, factory automation equipment, test and measurement equipment, communications, transportation equipment(automobiles, ships, trains, etc.), provided, however, that operation is not influenced by TFT-LCD directly.

(2) Special Usage

Medical equipment, safety equipment, transportation equipment, provided, however, that TFT-LCD is necessary to its operation.

(3) Specific Usage

Cockpit Equipment, military systems, aerospace equipment, nuclear reactor control systems, life support systems and any other equipment. OPTREX should make a contract that stipulate apportionment of responsibilities between OPTREX and our customer.

The product specified in this document is designed for "Standard Usage" unless otherwise specified in this document. If customers intend to use the product for applications other than those specified for "Standard Usage", they should contact OPTREX sales representative in advance.

OPTREX has been making continuous effort to improve the reliability of its products. Customers should implement sufficient reliability design of their application equipments such as redundant system design, fail-safe functions, anti-failure features.

OPTREX assumes no responsibility for any damage resulting from the use of the product that does not comply with the instructions and the precautions specified in this document.

Please contact and consult a OPTREX sales representative for any questions regarding this product.

2. OVERVIEW

T-51513D104J-FW-A-AJN is 10.4" color TFT-LCD (Thin Film Transistor Liquid Crystal Display) module composed of LCD panel, driver ICs, control circuit, and backlight unit.

By applying 6 bit digital data 640×480 , 262K-color images are displayed on the 10.4" diagonal screen. Input power voltage is 3.3 V for LCD driving.

The type of data and control signals are digital and transmitted via CMOS interface per Typ. 25 MHz clock cycle.

Inverter for backlight is not included in this module. General specifications are summarized in the following table:

ITEM	SPECIFICATION
Display Area (mm)	211.2(H) \times 158.4 (V) (10.39-inch diagonal)
Number of Dots	640 \times 3 (H) \times 480 (V)
Pixel Pitch (mm)	0.33 (H) \times 0.33 (V)
Color Pixel Arrangement	RGB vertical stripe
Display Mode	Normally white TN
Number of Color	262K
Luminance (cd/m ²)	430
Wide Viewing Angle Technology	Optical compensation film
Viewing Angle (CR \geq 10)	-65~65° (H) -65~45° (V)
Surface Treatment	Antiglare and hard-coating 3H
Electrical Interface	CMOS
Optimum Viewing Angle (Contrast ratio)	6 o'clock
Module Size (mm)	243.0 (W) \times 181.6 (H) \times 12.2 (D)
Module Mass (g)	570
Backlight Unit	CCFL, 2-tubes, edge-light, replaceable

Characteristic value without any note is typical value.

3. ABSOLUTE MAXIMUM RATINGS

ITEM	SYMBOL	MIN.	MAX.	UNIT
Power Supply Voltage for LCD	VCC	-0.3	4.0	V
Logic Input Voltage	VI	-0.3	6.0	V
Lamp Voltage	VL	0	2000	Vrms
Lamp Current	IL	0	9	mArms
Lamp Frequency	FL	40	100	kHz
Operation Temperature (Panel) <small>Note 1,2)</small>	T _{op(Panel)}	-20	70	°C
Operation Temperature (Ambient) <small>Note 2)</small>	T _{op(Ambient)}	-20	70	°C
Storage Temperature <small>Note 2)</small>	T _{stg}	-20	80	°C

[Note]

1) Measured at the center of active area and at the center of panel back surface

2) Top, Tstg ≤ 40°C : 90%RH max. without condensation

Top, Tstg > 40°C : Absolute humidity shall be less than the value of 90%RH at 40°C without condensation.

4. ELECTRICAL CHARACTERISTICS

(1) TFT- LCD

Ambient temperature: Ta = 25

ITEM	SYMBOL	MIN.	TYP.	MAX.	UNIT	Remarks
Power Supply Voltage for LCD	VCC	3.0	3.3	3.6	V	*1)
Power Supply Current for LCD	ICC	--	200	300	mA	*2)
Permissive Input Ripple Voltage	VRP	--	--	100	mVp-p	
Logic Input Voltage	High	VIH	2.0	--	5.5	V
	Low	VIL	0	--	0.8	V

*1) Power and signals sequence:

$$t1 \leq 10 \text{ ms} \quad 200 \text{ ms} \leq t4$$

$$0 < t2 \leq 50 \text{ ms} \quad 200 \text{ ms} \leq t5$$

$$0 < t3 \leq 50 \text{ ms} \quad 0 \leq t6$$

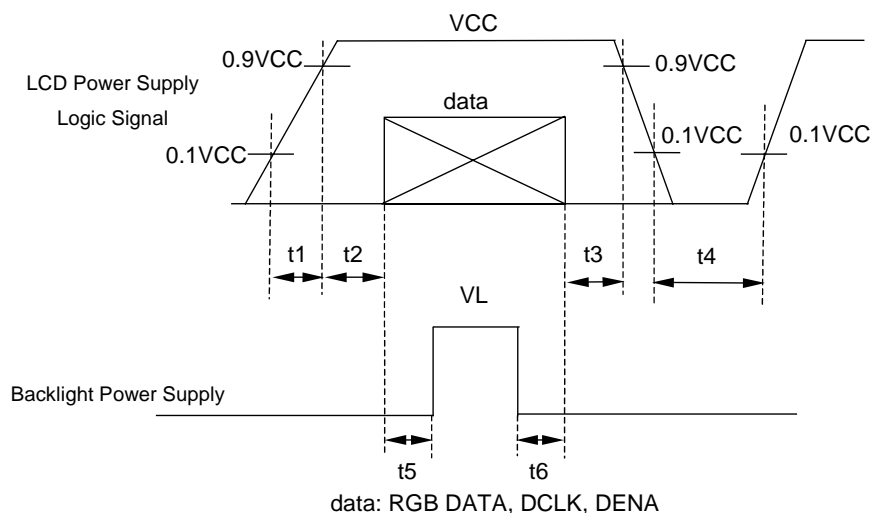

VCC-dip conditions:

- 1) When $2.4\text{ V} \leq \text{VCC} < 3.0\text{ V}$, $t_d \leq 10\text{ ms}$
- 2) When $\text{VCC} < 2.4\text{ V}$

VCC-dip conditions should also follow the power and signals sequence.

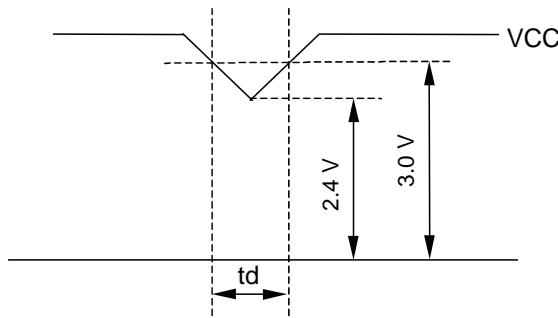

*2) Typical current condition:

64- gray- bar-pattern
480 line mode

$\text{VCC} = + 3.3\text{ V}$, $f_H=31.5\text{kHz}$, $f_V=60\text{Hz}$, $f_{\text{CLK}}= 25\text{MHz}$

(2) Backlight

$T_a=25^\circ\text{C}$

ITEM	SYMBOL	MIN.	TYP.	MAX.	UNIT	Remarks
Lamp Voltage	VL	--	485	--	Vrms	$I_L=6.0\text{ mArms}$
Lamp Current	IL	3.0	6.0	7.0	mArms	*1), *5)
Lamp Frequency	FL	40	--	100	kHz	*2)
Starting Lamp Voltage	VS	900	--	--	Vrms	$T_a = 25^\circ\text{C}$
		1350	--	--	Vrms	$T_a = 0^\circ\text{C}$
		1440	--	--	Vrms	$T_a = -20^\circ\text{C}$
Lamp Life Time	LT	50000	--	--	h	*3), *4) $I_L=6.0\text{mArms}$ Continuous Operation

*1) Lamp Current measurement method (The current meter is inserted in low voltage line.)

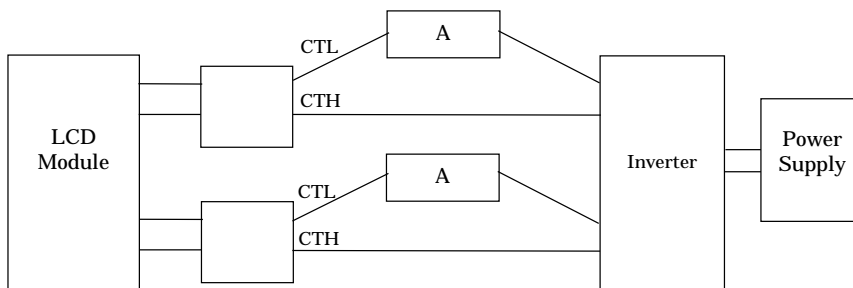

*2) Lamp frequency of inverter may produce interference with horizontal synchronous frequency, and this may cause horizontal beat on the display. Therefore, please adjust lamp frequency, and keep inverter as far from module as possible or use electronic shielding between inverter and module to avoid the interference.

*3) Lamp life time is defined as the time either when the brightness becomes 50% of the initial value, or when the starting lamp voltage does not meet the value specified in this table.

- *4) The life time of the backlight depends on the ambient temperature. The life time will decrease under low/high temperature.
- *5) Please use the inverter which has symmetrical current wave form as follows,
 The degree of unbalance: less than 10%
 The ratio of wave height: less than $\sqrt{2} \pm 10\%$

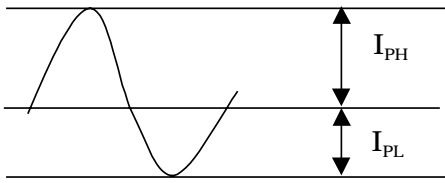

I_{PH} : High side peak

I_{PL} : Low side peak

The degree of unbalance = $|I_{PH} - I_{PL}| / I_{rms} \times 100(\%)$

The ratio of wave height = $I_{PH}(\text{or } I_{PL}) / I_{rms}$

CURRENT WAVE FORM

5. INTERFACE PIN CONNECTION

(1) CN 1(Interface Signal)

Used connector: DF9B-31P-1V(32)(HIROSE)

Corresponding connector: DF9-31S-1V(HIROSE)

Pin No.	Symbol	Function
1	GND	
2	DCLK	Clock signal for sampling catch data signal
3	HD	Horizontal sync signal *1)
4	VD	Vertical sync signal *1)
5	GND	
6	R0	Red data signal(LSB)
7	R1	Red data signal
8	R2	Red data signal
9	R3	Red data signal
10	R4	Red data signal
11	R5	Red data signal(MSB)
12	GND	
13	G0	Green data signal(LSB)
14	G1	Green data signal
15	G2	Green data signal
16	G3	Green data signal
17	G4	Green data signal
18	G5	Green data signal(MSB)
19	GND	
20	B0	Blue data signal(LSB)
21	B1	Blue data signal
22	B2	Blue data signal
23	B3	Blue data signal
24	B4	Blue data signal
25	B5	Blue data signal(MSB)
26	GND	
27	DENA	Data enable signal (to settle the viewing area)
28	VCC	3.3 V Power Supply
29	VCC	3.3 V Power Supply
30	GND	
31	SC	Scan direction control (Low=Normal, High=Reverse)

*1) HD and VD are not being used for timing control.

*2) The shielding case is connected with GND

(2) CN 2, 3 (Backlight)

Backlight-side connector: BHR-02(8.0)VS-1N(JST)

Inverter-side connector: SM02(8.0)B-BHS(JST)

Pin No.	Symbol	Function
1	CTH	VBLH (High Voltage)
2	CTL	VBLL (Low Voltage)

[Note]VBLH-VBLL=VL

6. INTERFACE TIMING

(1) Timing Specifications

ITEM		SYMBOL	MIN.	TYP.	MAX.	UNIT	
DCLK	Frequency	f _{CLK}	20	25	30	MHz	
	Period	t _{CLK}	33.3	40	50	ns	
	Low Width	t _{WCL}	10	--	--	ns	
	High Width	t _{WCH}	10	--	--	ns	
DATA (R,G,B,DENA)	Set up time	t _{DS}	4	--	--	ns	
	Hold time	t _{DH}	4	--	--	ns	
DENA	Horizontal	Active Time	t _{HA}	640	640	640	t _{CLK}
		Blanking Time	t _{HB}	20	160	--	t _{CLK}
		Frequency	f _H	27	31.5	38	kHz
		Period	t _H	26.3	31.7	37.0	μs
	Vertical	Active Time	t _{VA}	480	480	480	t _H
		Blanking Time	t _{VB}	3	45	--	t _H
		Frequency	f _V	55	60	70	Hz
		Period	t _V	14.3	16.7	18.2	ms

[Note]

- 1) DATA is latched at fall edge of DCLK in this specification.
- 2) DENA (Data Enable) should always be positive polarity as shown in the timing specification.
- 3) DCLK should appear during all invalid period.

(2) Timing Chart

a. Pixel Timing Chart

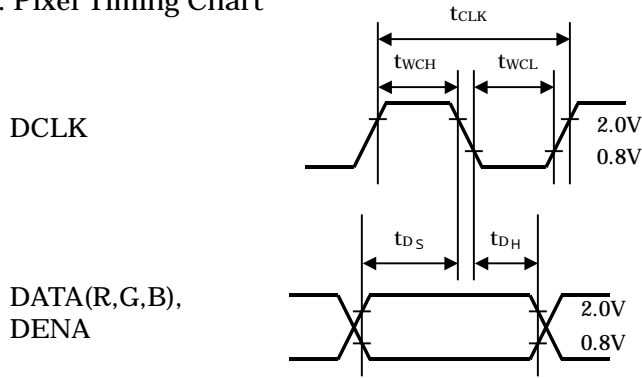

b. Horizontal Timing Chart

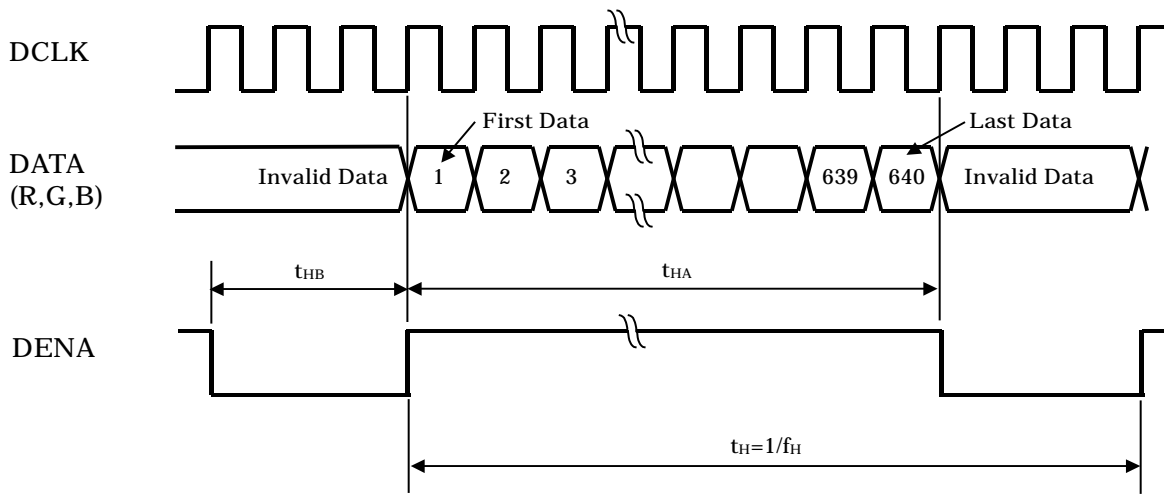

c. Vertical Timing Chart

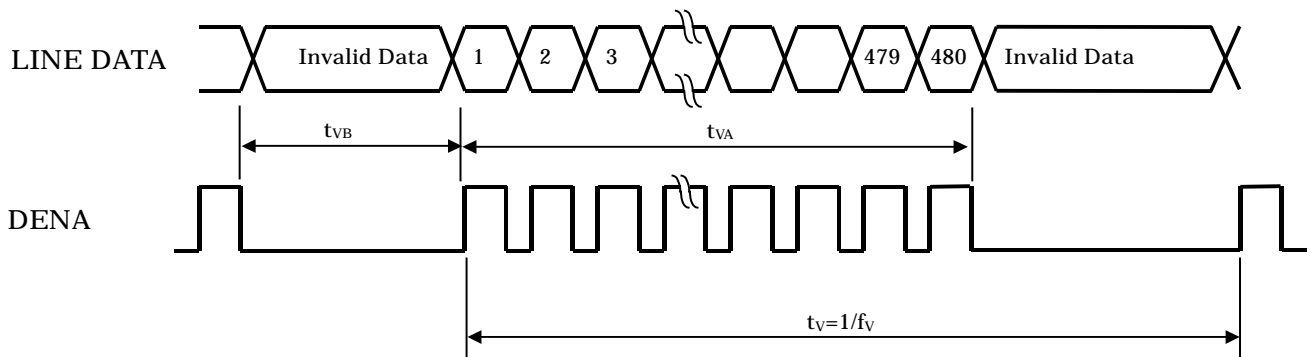

(3) Color Data Assignment

COLOR		INPUT DATA																	
		R DATA						G DATA						B DATA					
		R5	R4	R3	R2	R1	R0	G5	G4	G3	G2	G1	G0	B5	B4	B3	B2	B1	B0
		MSB					LSB	MSB					LSB	MSB					LSB
BASIC COLOR	BLACK	0	0	0	0	0	0	0	0	0	0	0	0	0	0	0	0	0	0
	RED(63)	1	1	1	1	1	1	0	0	0	0	0	0	0	0	0	0	0	0
	GREEN(63)	0	0	0	0	0	0	1	1	1	1	1	1	0	0	0	0	0	0
	BLUE(63)	0	0	0	0	0	0	0	0	0	0	0	0	1	1	1	1	1	1
	CYAN	0	0	0	0	0	0	1	1	1	1	1	1	1	1	1	1	1	1
	MAGENTA	1	1	1	1	1	1	0	0	0	0	0	0	1	1	1	1	1	1
	YELLOW	1	1	1	1	1	1	1	1	1	1	1	1	0	0	0	0	0	0
	WHITE	1	1	1	1	1	1	1	1	1	1	1	1	1	1	1	1	1	1
RED	RED(1)	0	0	0	0	0	1	0	0	0	0	0	0	0	0	0	0	0	0
	RED(2)	0	0	0	0	1	0	0	0	0	0	0	0	0	0	0	0	0	0
	RED(62)	1	1	1	1	1	0	0	0	0	0	0	0	0	0	0	0	0	0
	RED(63)	1	1	1	1	1	1	0	0	0	0	0	0	0	0	0	0	0	0
GREEN	GREEN(1)	0	0	0	0	0	0	0	0	0	0	0	1	0	0	0	0	0	0
	GREEN(2)	0	0	0	0	0	0	0	0	0	0	1	0	0	0	0	0	0	0
	GREEN(62)	0	0	0	0	0	0	1	1	1	1	1	0	0	0	0	0	0	0
	GREEN(63)	0	0	0	0	0	0	1	1	1	1	1	1	0	0	0	0	0	0
BLUE	BLUE(1)	0	0	0	0	0	0	0	0	0	0	0	0	0	0	0	0	0	1
	BLUE(2)	0	0	0	0	0	0	0	0	0	0	0	0	0	0	0	0	1	0
	BLUE(62)	0	0	0	0	0	0	0	0	0	0	0	0	1	1	1	1	1	0
	BLUE(63)	0	0	0	0	0	0	0	0	0	0	0	0	1	1	1	1	1	1

[Note]

- 1) Definition of gray scale
 Color (m) --- n indicates gray scale level.
 Higher n means brighter level.
- 2) Data
 1:High, 0: Low

(4) Display Position and Scan Direction

D(X,Y) shows the data number of input signal for LCD panel signal processing PCB.

SC: Low

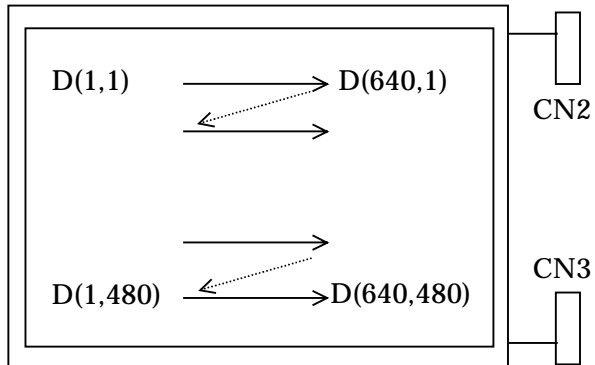

SC: High

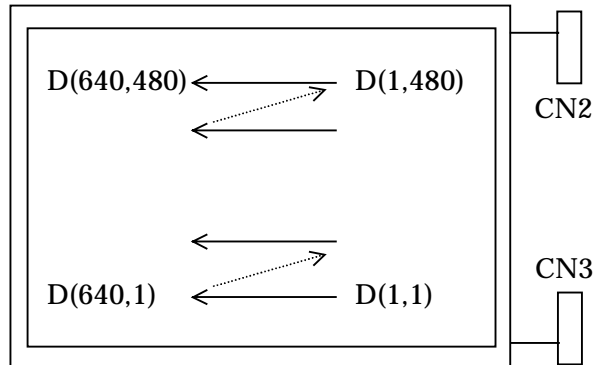

7. BLOCK DIAGRAM

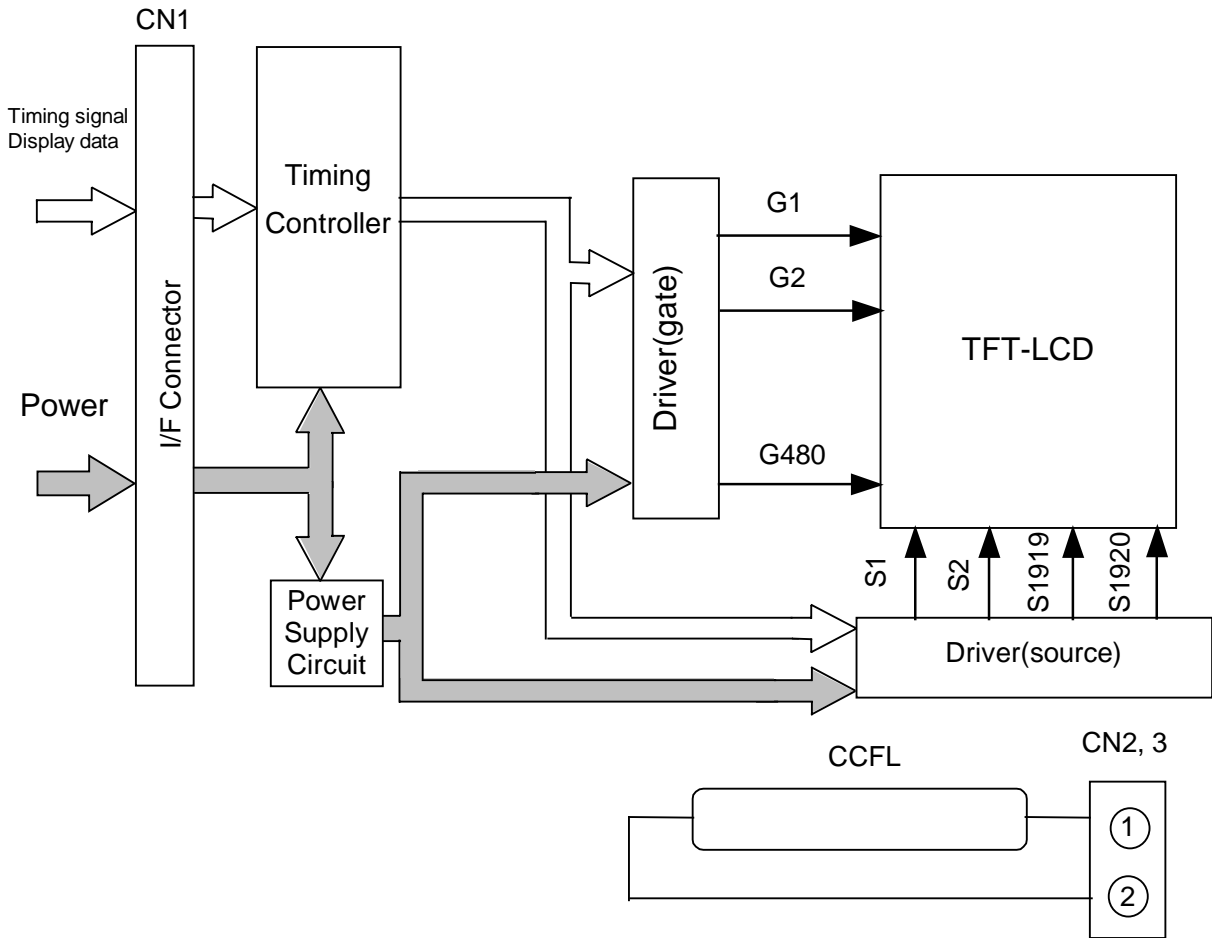

8. MECHANICAL SPECIFICATIONS

(1) Front Side

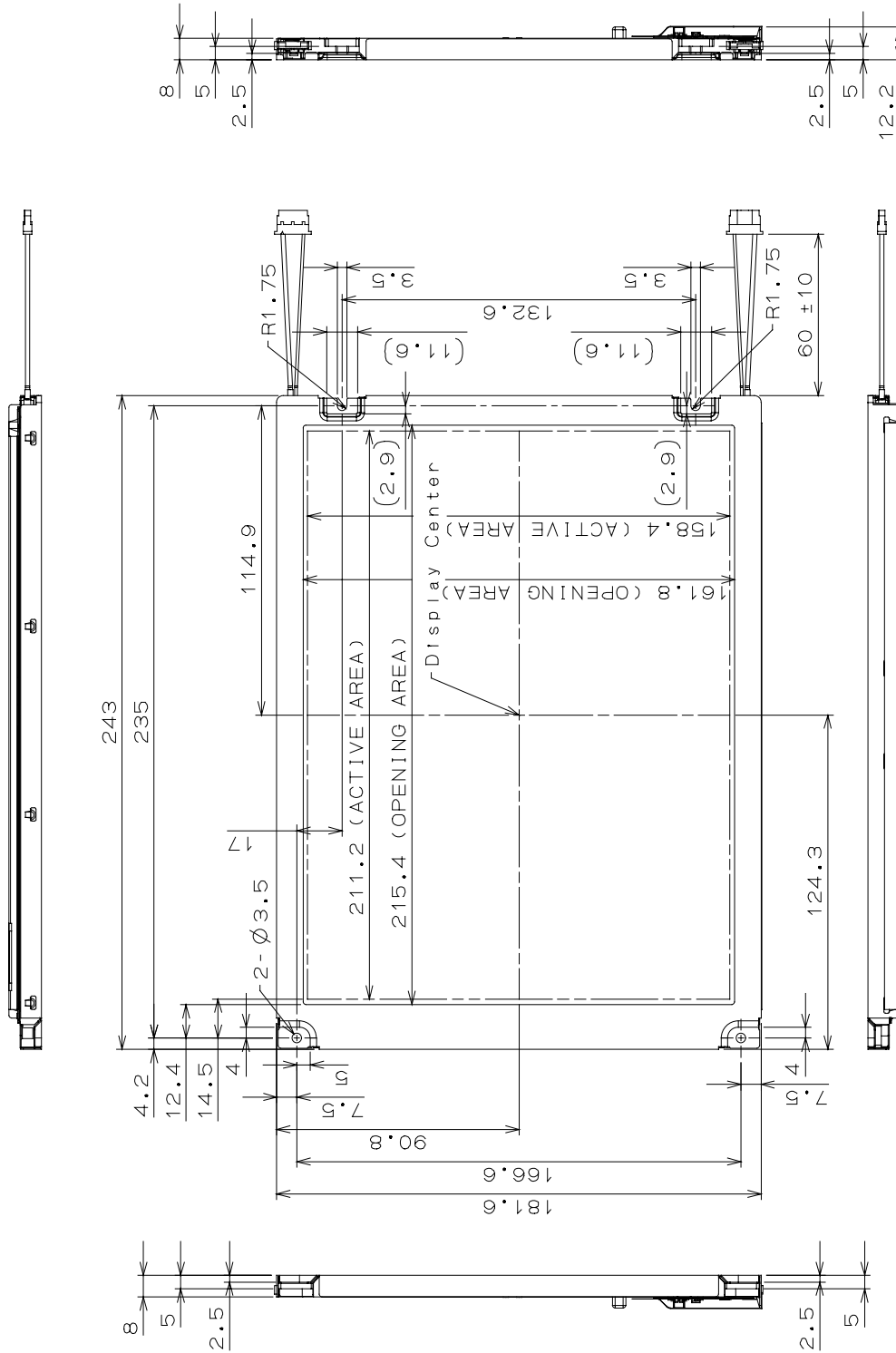

1) Tolerance is ± 0.5 mm unless noted
 2) Except for thickness of PET film

(Unit:mm)

(2) Rear Side

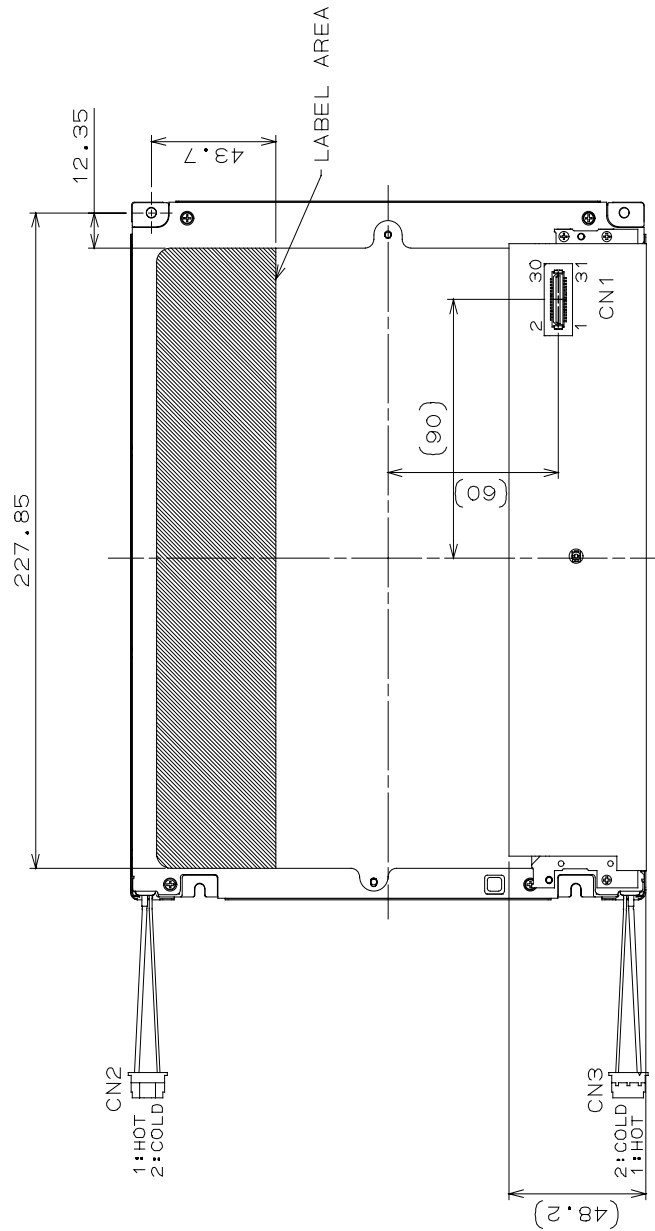

1) Tolerance is $\pm 0.5\text{mm}$ unless noted
 2) Except for thickness of PET film

CN1: DF9B-31P-1V(32)(HIROSE)
 CN2, CN3: BHR-02(8.0)VS-1N(JST)

(Unit:mm)

[Note]

We recommend you referring to the detailed drawing for your design.
 Please contact our company sales representative when you need the detailed drawing.

9. OPTICAL CHARACTERISTICS

Ta=25°C, VCC=3.3 V, Input Signals: Typ. Values shown in Section 6

ITEM	SYMBOL	CONDITION	MIN.	TYP.	MAX.	UNIT	Remarks	
Contrast Ratio	CR	$\theta_V=0^\circ, \theta_H=0^\circ$	350	500	--	--	*1)*2)*5)	
Luminance	Lw	$\theta_V=0^\circ, \theta_H=0^\circ$	340	430	--	cd/m ²	*1)*5)	
Luminance Uniformity	ΔLw	$\theta_V=0^\circ, \theta_H=0^\circ$	--	--	30	%	*1)*3)*5)	
Response Time	tr	$\theta_V=0^\circ, \theta_H=0^\circ$	--	6	--	ms	*1)*4)*5)	
	tf	$\theta_V=0^\circ, \theta_H=0^\circ$	--	19	--	ms	*1)*4)*5)	
Viewing Angle	Horizontal	θ_H	CR \geq 10	-50~50	-65~65	--	°	*1)*5)
	Vertical	θ_V		-40~30	-65~45	--	°	*1)*5)
	Horizontal	θ_H	CR \geq 5	-65~65	-80~80	--		*1)*5)
	Vertical	θ_V		-50~40	-80~50	--		*1)*5)
Image Sticking	tis	2 h	--	--	2	s	*6)	
Color Coordinates	Red	Rx	$\theta_V=0^\circ, \theta_H=0^\circ$	0.554	0.584	0.614	--	*1)*5)
		Ry		0.301	0.331	0.361		
	Green	Gx		0.299	0.329	0.359		
		Gy		0.503	0.533	0.563		
	Blue	Bx		0.132	0.162	0.192		
		By		0.130	0.160	0.190		
	White	Wx		0.283	0.313	0.343		
		Wy		0.299	0.329	0.359		

[Note]

These items are measured using CS1000(MINOLTA) for color coordinates, EZContrast(ELDIM) for viewing angle and CS1000 or BM-5A(TOPCON) for others under the dark room condition (no ambient light) after more than 30 minutes from turning on the lamp unless noted.

Condition: IL=6.0 mArms, FL=55 kHz

Measurement method for luminance and color coordinates is as follows.

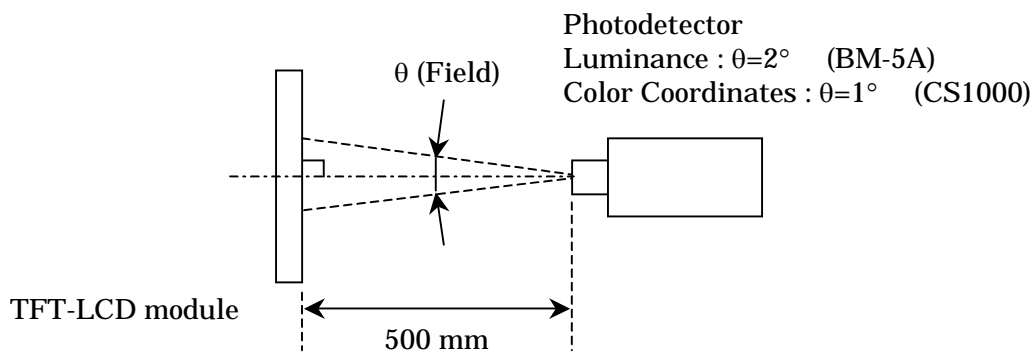

The luminance is measured according to FLAT PANEL DISPLAY MEASUREMENTS STANDARD (VESA Standard).

*1) Measurement Point

Contrast Ratio, Luminance, Response Time, Viewing Angle, Color Coordinates: Display Center
 Luminance Uniformity: point 1~5 shown in a figure below

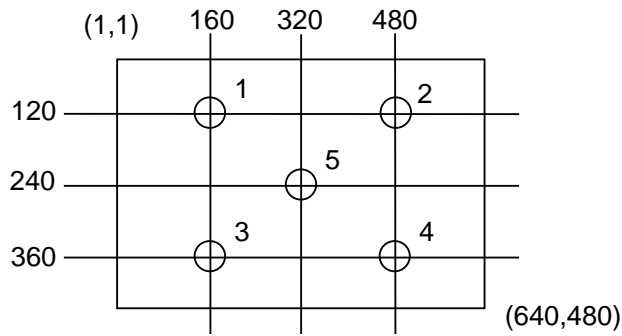

*2) Definition of Contrast Ratio

CR=Luminance with all white pixels / Luminance with all black pixels

*3) Definition of Luminance Uniformity

$$\Delta Lw = [Lw(\text{MAX}) / Lw(\text{MIN}) - 1] \times 100$$

*4) Definition of Response Time

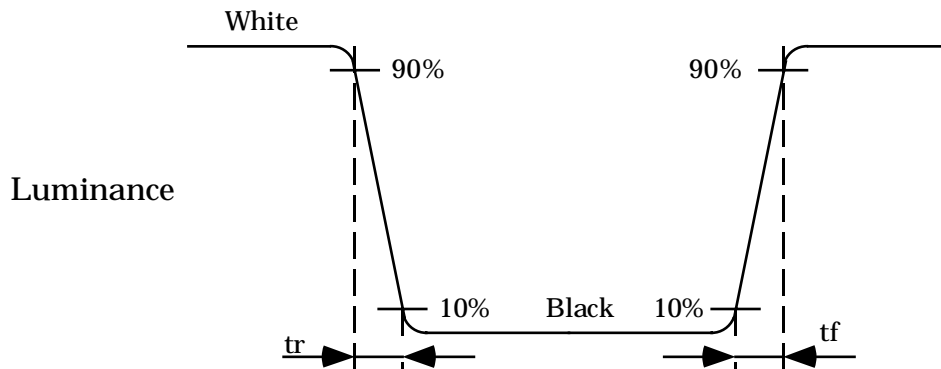

*5) Definition of Viewing Angle (θ_v , θ_H)

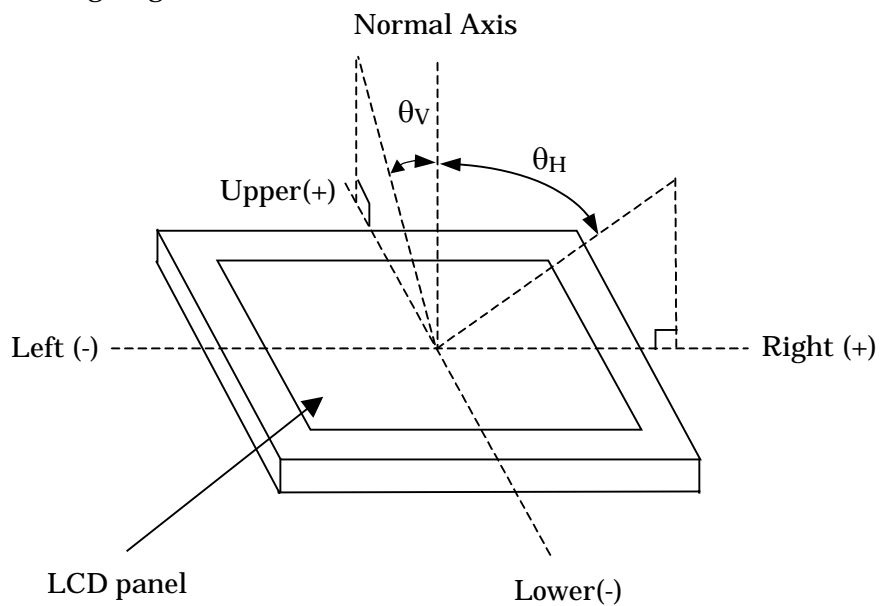

***6) Image Sticking**

Continuously display the test pattern shown in the figure below for two-hours. Then display a completely white screen. The previous image shall not persist more than two seconds at 25°C.

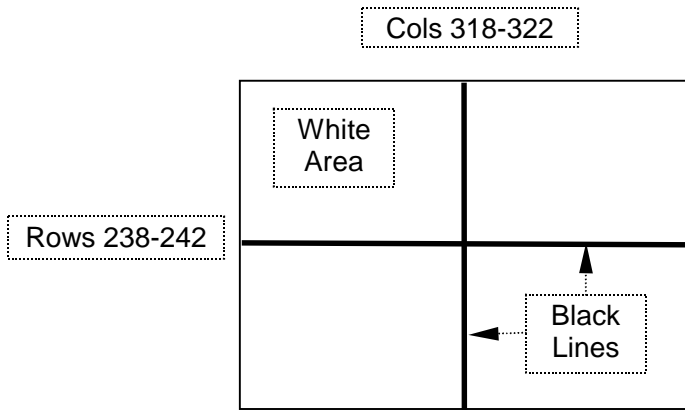

TEST PATTERN FOR IMAGE STICKING TEST

10. RELIABILITY TEST CONDITION

(1) Temperature and Humidity

ITEM	CONDITIONS
HIGH TEMPERATURE HIGH HUMIDITY OPERATION	40°C, 90%RH, 240 h (No condensation)
HIGH TEMPERATURE OPERATION	70°C, 240 h
LOW TEMPERATURE OPERATION	-20°C, 240 h
HIGH TEMPERATURE STORAGE	80°C, 240 h
LOW TEMPERATURE STORAGE	-20°C, 240 h
THERMAL SHOCK (NON-OPERATION)	BETWEEN -20°C (1h) and 80°C(1h), 100 CYCLES

(2) Shock & Vibration

ITEM	CONDITIONS
SHOCK (NON-OPERATION)	Shock level: 1470m/s ² (150G) Waveform: half sinusoidal wave, 2ms Number of shocks: one shock input in each direction of three mutually perpendicular axis for a total of six shock inputs
VIBRATION (NON-OPERATION)	Vibration level: 9.8m/s ² (1.0G) Waveform: sinusoidal Frequency range: 5 to 500Hz Frequency sweep rate: 0.5 octave /min Duration: one sweep from 5 to 500 Hz in each of three mutually perpendicular axis(total 3 hours)

(3) Judgment standard

The judgment of the above tests should be made as follow:

Pass: Normal display image, no damage of the display function. (ex. no line defect)

Partial transformation of the module parts should be ignored.

Fail: No display image, damage of the display function. (ex. line defect)

11. INSPECTION STANDARDS

Inspection condition is as follows:

- Viewing distance: approximately 35 cm.
- Viewing angle: normal to the LCD panel $\pm 10^\circ$ horizontal and vertical.
- Ambient temperature: approximately 25°C.
- Ambient light: 300 - 500 lx.

Bright Dot is defined as follows:

Visible through 5% transmission ND filter under the condition that black image (color 0) is on the display.

DEFECT TYPE		LIMIT	
VISUAL DEFECT	SCRATCH	$0.01 \text{ mm} < W \leq 0.05 \text{ mm}$ $L \leq 10 \text{ mm}$	$N \leq 4$
		$0.01 \text{ mm} < W$ $10 \text{ mm} < L$	$N = 0$
		$0.05 \text{ mm} < W$	$N = 0$
	DENT	$0.2 \text{ mm} < \phi \leq 0.4 \text{ mm}$	$N \leq 4$
		$0.4 \text{ mm} < \phi$	$N = 0$
	BLACK SPOT BUBBLE	$0.2 \text{ mm} < \phi \leq 0.4 \text{ mm}$	$N \leq 5$
		$0.4 \text{ mm} < \phi$	$N = 0$
	LINT	$L \leq 3 \text{ mm}$ $W \leq 0.1 \text{ mm}$	$N \leq 4$
		$3 \text{ mm} < L$ $W \leq 0.1 \text{ mm}$	$N = 0$
$0.1 \text{ mm} < W$		ACCORDING TO BLACK SPOT	
ELECTRICAL DEFECT	BRIGHT DOT	$N \leq 5$	
	DARK DOT	$N \leq 5$	
	TOTAL DOT	$N \leq 8$	
	TWO ADJACENT DOT BRIGHT DOT DARK DOT	$\leq 2 \text{ PAIRS}$ $\leq 2 \text{ PAIRS}$	
	THREE OR MORE ADJACENT DOT	NOT ALLOWED	
	LINE DEFECT	NOT ALLOWED	

*1) W: width,L: length, ϕ : diameter,N: number

*2) DEFINITION OF ADJACENT

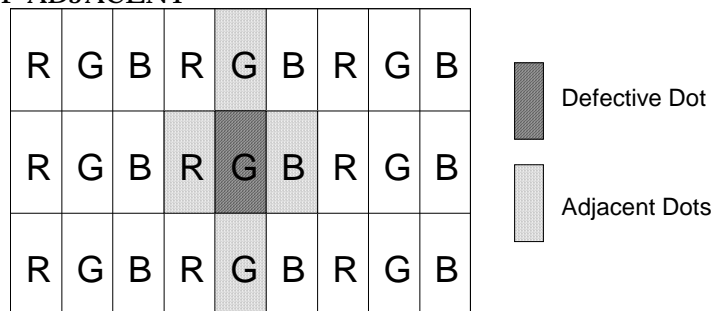

The defects that are not defined above and considered to be problem shall be reviewed and discussed by both parties.

12. OTHER FEATURE

This LCD module complies with RoHS. *)

*) RoHS: Restriction of the use of certain hazardous substances in electrical and electronic equipment

13. HANDLING PRECAUTIONS FOR TFT-LCD MODULE

Please pay attention to the followings in handling TFT-LCD products;

(1) ASSEMBLY PRECAUTION

- a. Please use the mounting hole on the module in installing and do not bending or wrenching LCD in assembling. And please do not drop, bend or twist LCD module in handling.
- b. Please design display housing in accordance with the following guide lines.
 - (a) Housing case must be designed carefully so as not to put stresses on LCD all sides and not to wrench module. The stresses may cause non-uniformity even if there is no non-uniformity statically.
 - (b) Keep sufficient clearance between LCD module back surface and housing when the LCD module is mounted. Approximately 1.0mm of the clearance in the design is recommended taking into account the tolerance of LCD module thickness and mounting structure height on the housing.
 - (c) When some parts, such as, FPC cable and ferrite plate, are installed underneath the LCD module, still sufficient clearance is required, such as 0.5mm. This clearance is, especially, to be reconsidered when the additional parts are implemented for EMI countermeasure.
 - (d) Design the inverter location and connector position carefully so as not to give stress to lamp cable, or not to interface the LCD module by the lamp cable.
 - (e) Keep sufficient clearance between LCD module and the others parts, such as inverter and speaker so as not to interface the LCD module. Approximately 1.0mm of the clearance in the design is recommended.
 - (f) To avoid local elevation/decrease of temperature, considering location of heating element, heat release, thermal design should be done.
- c. Please do not push or scratch LCD panel surface with anything hard. And do not soil LCD panel surface by touching with bare hands. (Polarizer film, surface of LCD panel is easy to be flawed.)
- d. Please do not press any parts on the rear side such as source TCP, gate TCP, control circuit board and FPCs during handling LCD module. If pressing rear part is unavoidable, handle the LCD module with care not to damage them.
- e. Please wipe off LCD panel surface with absorbent cotton or soft cloth in case of it being soiled.
- f. Please wipe off drops of adhesives like saliva and water on LCD panel surface immediately. They might damage to cause panel surface variation and color change.
- g. Please do not take a LCD module to pieces and reconstruct it. Resolving and reconstructing modules may cause them not to work well.
- h. Please do not touch metal frames with bare hands and soiled gloves. A color change of the metal frames can happen during a long preservation of soiled LCD modules.
- i. Please handle metal frame carefully because edge of metal frame is very sharp.
- j. Please pay attention to handling lead wire of backlight so that it is not tugged in connecting with inverter.
- k. Please connect the metal frame of LCD module to GND in order to minimize the effect of external noise and EMI.

- l. Be sure to connect the cables and the connectors correctly.

(2) OPERATING PRECAUTIONS

- a. Please be sure to turn off the power supply before connecting and disconnecting signal input cable.
- b. Please do not change variable resistance settings in LCD module. They are adjusted to the most suitable value. If they are changed, it might happen LCD does not satisfy the characteristics specification.
- c. LCD backlight takes longer time to become stable of radiation characteristics in low temperature than in room temperature.
- d. The interface signal speed is very high. Please pay attention to transmission line design and other high speed signal precautions to satisfy signal specification.
- e. A condensation might happen on the surface and inside of LCD module in case of sudden change of ambient temperature.
- f. Please pay attention not to display the same pattern for very long time. Image might stick on LCD. Even if image sticking happens, it may disappear as the operation time proceeds.
- g. Please obey the same safe instructions as ones being prepared for ordinary electronic products.

(3) PRECAUTIONS WITH ELECTROSTATICS

- a. This LCD module use CMOS-IC on circuit board and TFT-LCD panel, and so it is easy to be affected by electrostatics. Please be careful with electrostatics by the way of your body connecting to the ground and so on.
- b. Please remove protection film very slowly from the surface of LCD module to prevent from electrostatics occurrence.

(4) STORAGE PRECAUTIONS

- a. Please do not leave the LCDs in the environment of high humidity and high temperature such as 60°C90%RH.
- b. Please do not leave the LCDs in the environment of low temperature; below -20°C.

(5) SAFETY PRECAUTIONS

- a. When you waste damaged or unnecessary LCDs, it is recommended to crush LCDs into pieces and wash them off with solvents such as acetone and ethanol, which should later be burned.
- b. If any liquid leaks out of a damaged glass cell and comes in contact with the hands, wash off thoroughly with soap and water.
- c. Be sure to turn off the power supply when inserting or disconnecting the cable.
- d. Inverter should be designed carefully so as not to keep working in case of detecting over current or open circuit on the lamp.

(6) OTHERS

- a. A strong incident light into LCD panel might cause display characteristics changing inferior because of polarizer film, color filter, and other materials becoming inferior. Please do not expose LCD module direct sunlight and strong UV rays.
- b. Please pay attention to a panel side of LCD module not to contact with other materials in preserving it alone.
- c. For the packaging box, please pay attention to the followings;
 - (a) Packaging box and inner case for LCD are designed to protect the LCDs from the damage or scratching during transportation. Please do not open except picking LCDs up from the box.
 - (b) Please do not pile them up more than 5 boxes. (They are not designed so.) And please do not turn over.
 - (c) Please handle packaging box with care not to give them sudden shock and vibrations. And also please do not throw them up.
 - (d) Packaging box and inner case for LCDs are made of cardboard. So please pay attention not to get them wet. (Such like keeping them in high humidity or wet place can occur getting them wet.)

PACKAGING SPECIFICATION

1. PACKAGING BOX

material: cardboard, polyethylene form (Anti-electrostatic spec.)
construction: See Fig. 1
max. packaging number: 10 pcs.
dimension: 457(W) × 302(D) × 422(H) [mm]
mass(including 10 modules): 7.0 kg
label: Labels are put on the box.(See Fig. 2, 3, 4,)

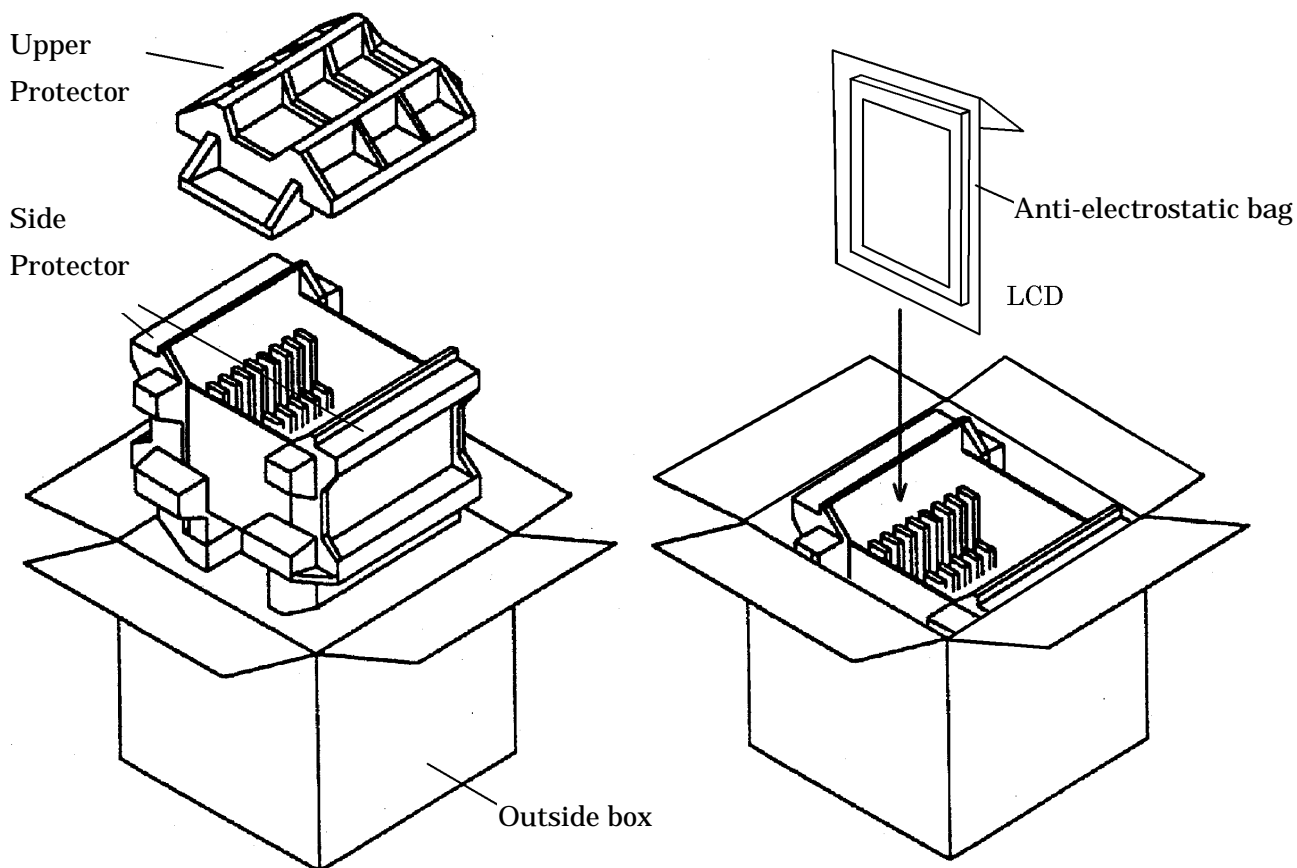

Fig.1 Illustration of packaging box structure

Product name	Packaging number
Bar-code	Bar-code
Serial No.	Serial No.
Bar-code	Bar-code
Serial No.	Serial No.
Bar-code	Bar-code
Serial No.	Serial No.
Bar-code	Bar-code
Serial No.	Serial No.
Bar-code	Bar-code

Fig.2 Label 1

Shipper	Box No.
	Mass
Shipping No.	
Bar-code	
Shipping No.	
Bar-code	
Packaging No.	
Bar-code	
Shipping No.	
Bar-code	
Products name	
Bar-code	

Fig.3 Label 2

Consignee
Product name
Product name of consignee
Order No.
Box No.
Place of production
Bar-code
Shipping date

Fig.4 Label 3

OPTREX
TFT - LCD : AA104VC10
T-51513D104J-FW-A-AJN
P / O NO. 123456789
C / S 001 OF 005
MADE IN JAPAN
 001
2001/11/15
JA1BK4144

Fig.5 Sample of Label 3

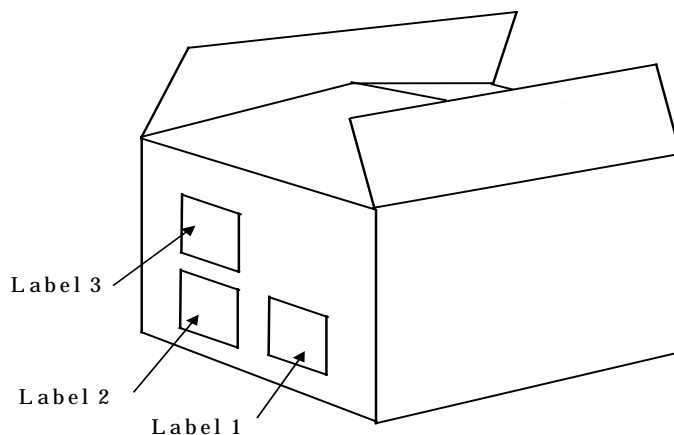

Fig.6 Location of labels

2. LOCATION OF LABEL ON THE PACKAGING BOX

Labels are put on the box.(See Fig.6)

3. PACKAGING FORM OF PRODUCT

- (1) Each of LCD modules is packed in anti-electrostatic bag(Fig.7).
- (2) The packaging box accumulates maximum 10 modules.
- (3) Upper protector is put on the products, and shut the box.

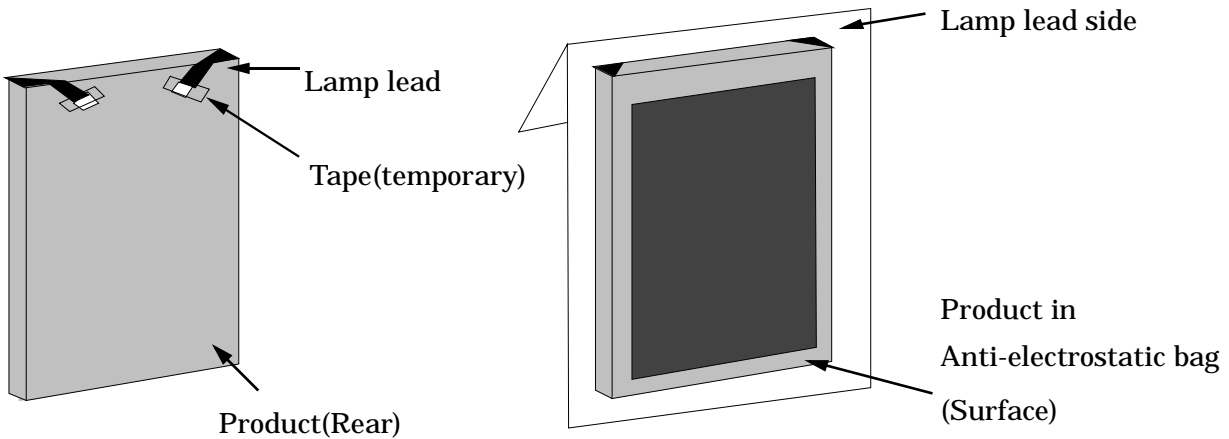

Fig.7

4. CAUTIONS OF SHIPPING & STORAGE

- (1) Do not turn the packaging upside down while storage and transportation. The boxes should not be piled up more than 5.
- (2) Handle with care. Keep off from rain & dew.
- (3) Keep off from direct sunlight exposure. Please store under room temperature & low humidity in original packaging condition when they were shipped.
- (4) Keep other cautions described in handling manual.

PRODUCTS NUMBER LABELING FORMS

Products number label is constructed as below;

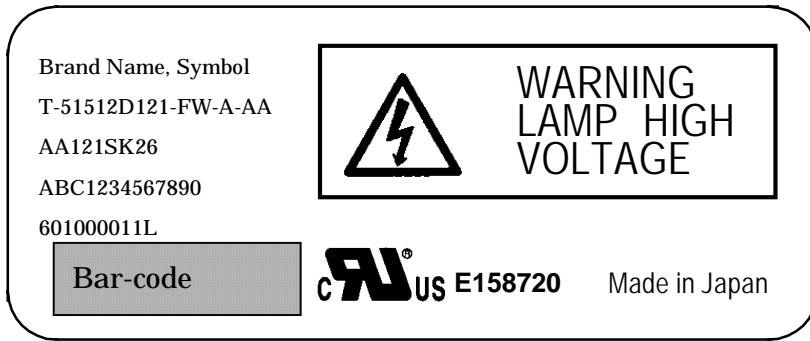

Brand Name, Symbol
 Products Name of Optrex
 Products Name
 Production Key Number(13Digits)
 Date Code
 (Serial Number, Factory Sign)
 Bar-code of Date Code
 UL File No.
 Production Country

Brand Name, Symbol

OPTREX

Products Name of Optrex

ex. T51512D121-FW-A-AA

Products Name

ex.1: AA121SK26 ex.2: AA150XA03 B

Production Key Number(13Digits)

(ID Number for Production Control)

Date Code (Serial Number, Factory Sign)

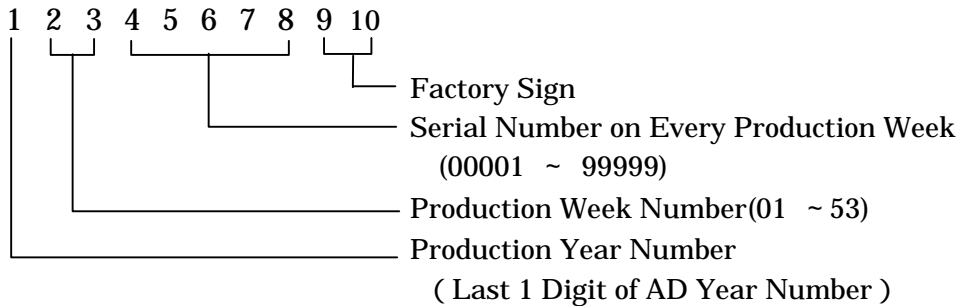

- Date Code is constructed by 9 Digits as below;
 - 1st Digit : Production Year Number (Last 1 Figure of AD Year)
 - 2nd ~ 3rd Digit : Production Week Number in a Year
 (A Year is divided to 53 weeks from Monday to Saturday)
 - 4th ~ 8th Digit : Serial Number on Every Production Weeks.
 (00001 ~ 99999)
 - These are numbered in order according to Production Name.
 - 9th ~ 10th Digit : Factory Sign (on the Module Test Process)
 (1L: Shisui Factory Line, 1W: CPT Fab-1, 1R: CPT Fab-2,
 1U: CPT Wujiang-LCM-1, 1V:CPT Wujiang-LCM-2)

Bar-code(Date Code)

Bar-code Line for computer reading Date Code mentioned as above.

UL File No.

MDTI: E158720, CPT: E194548

Production Country

MDTI: Made in Japan, CPT: Made in Taiwan/China

LAMP UNIT for 10.4"VGA

APPLICATION

This technical literature applies to the replaceable lamp unit that is the maintenance parts for 10.4"VGA TFT-LCD module industrial use (model name: T-51513D104J-FW-A-AJN).

MECHANICAL CHARACTERISTICS

Item	Specification	Remarks
Outline Dimension of Reflector	228.5 × 5.4 × 4.6 (mm)	Except Wire and Lamp Rubber Cushion
Mass	12 (g)(MAX)	
Lamp Diameter	φ2.4 (mm)	

See DRAWING OF OUTLINE DIMENTIONS

ENVIRONMENTAL CONDITIONS

Item	Operation		Non Operation		Remarks
	MIN	MAX	MIN	MAX	
Ambient Temperature	-20°C	70°C	-20°C	80°C	No Condensation

Ta ≤ 40°C : 90% RH max. without condensation

Ta > 40°C : Absolute humidity shall be less than the value of 90% RH at 40°C.

ELECTRICAL CHARACTERISTICS

Operation conditions

Item	Symbol	Condition	MIN	TYP	MAX	Unit	Remarks
Lamp Current	IL	Ta = 25°C	3.0	6.0	7.0	mArms	
Lamp Voltage	VL	Ta = 25°C	-	485	-	Vrms	
Starting Lamp Voltage	VS	Ta = 25°C	900	-	-	Vrms	
		Ta = 0°C	1350	-	-	Vrms	
		Ta = -20°C	1440	-	-	Vrms	
Lamp Frequency	FL	Ta = 25 , IL = 6.0 mArms	40	-	100	kHz	

*) Lamp Current measurement method (The current meter is inserted in low voltage line.)

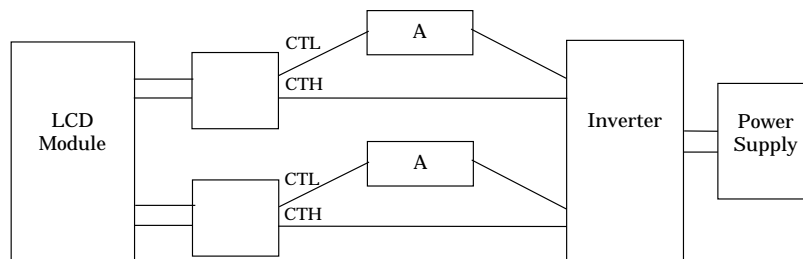

OPTICAL CHARACTERISTICS

Ta=25°C, 60±10%RH

Item	Symbol	MIN	TYP	MAX	Unit	Remarks
Luminance	Lw	340	430	-	cd/m ²	Measurement point shown in the figure below
Color Coordinates (White)	Wx	0.283	0.313	0.343	-	
	Wy	0.299	0.329	0.359	-	

[Conditions]

IL = 6.0mArms, Inverter frequency: 55 kHz

[Measurement Point]

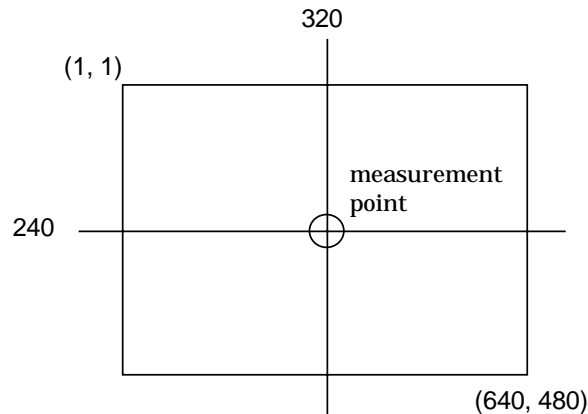

These items are measured when lamp unit are assembled into T-51513D104J-FW-A-AJN for color coordinates, and CS1000 or BM-5A(TOPCON) for Luminance under the dark room condition (no ambient light) after more than 30 minutes from turning on the lamp unless noted.

LIFE TIME OF THE LAMP UNIT

Environmental Conditions are as follows:

Ambient temperature is 25±5°C.

Lamp Current is 6.0 mArms.

Continuous Operation	50,000 hours
Number of turning on and off	100,000 times (30sec ON-OFF)

- (1) Lamp life time is defined as the time either when the brightness becomes 50% of the initial value, or when the starting lamp voltage does not meet the value specified in the table of section 4.
- (2) The life time of the backlight depends on the ambient temperature. The life time will decrease under low/high temperature.

INTERFACE PIN CONNECTION

Backlight-side connector: BHR-02(8.0)VS-1N(JST)

Inverter-side connector: SM02(8.0)B-BHS(JST)

Pin No.	Symbol	Function
1	CTH	VBLH (High voltage)
2	CTL	VBLL (Low voltage)

[Note]

VBLH - VBLL = VL

DRAWING OF OUTLINE DIMENSIONS

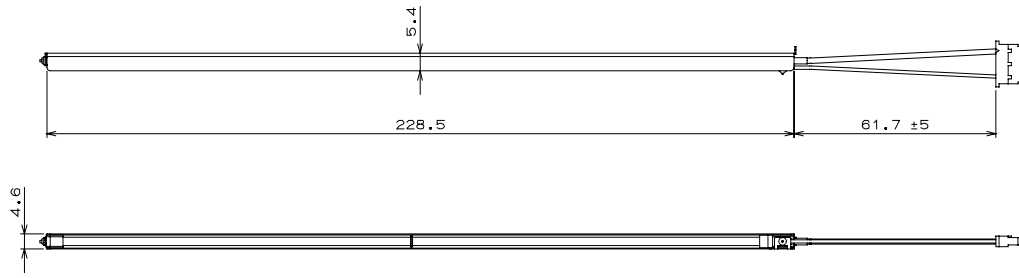

METHOD OF REPLACING THE LAMP UNIT

(1) Precautions

Please pay attention to the following items while replacing the Lamp Unit.

- a. Please do not damage the LCD Panel Surface, and do not touch it with bare hands.
(Wearing gloves is recommended.)
- b. Please be careful with electrostatics, and work in clean environment to prevent entering dust and/or foreign matters that will cause bad display image.
(Using clean bench or similar environment is recommended.)
- c. Please be careful of the edge of the frame metal.

(2) Method of replacing the Lamp Unit

- 1) Put the TFT-LCD Module on the table.(LCD Panel Surface is upside.)

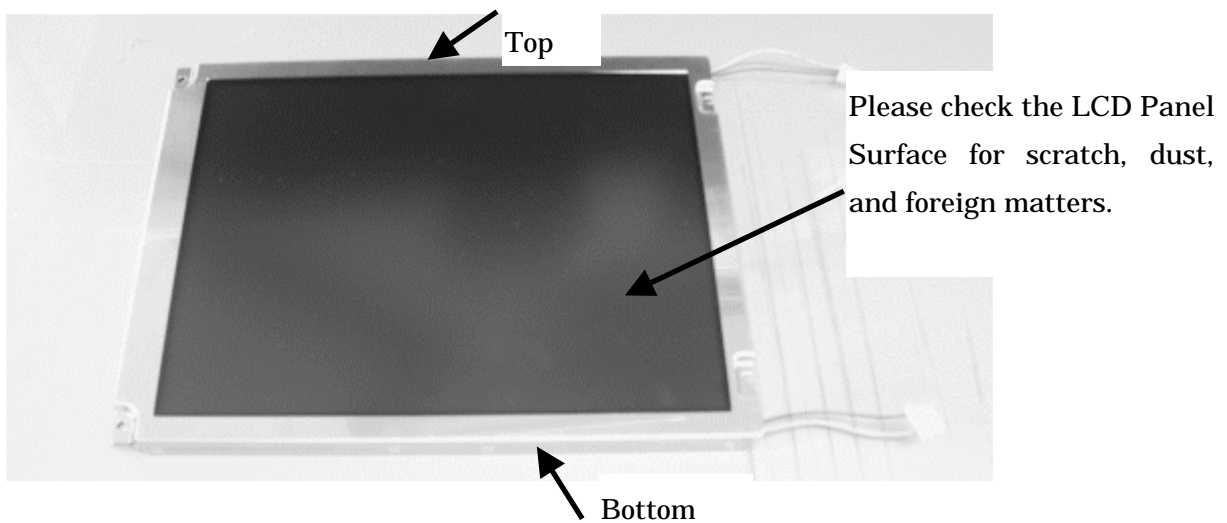

Picture 1

- 2) Turn the TFT-LCD Module upside down.

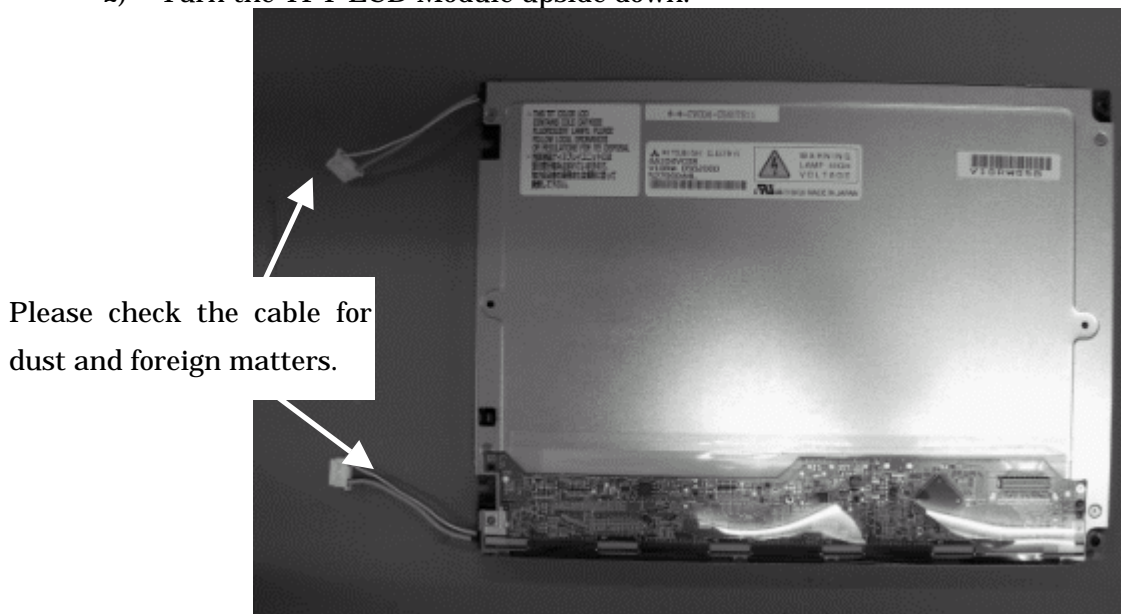

Picture 2

- 3) Stand the TFT-LCD Module up and push out the black latch that fastens the Lamp Unit.

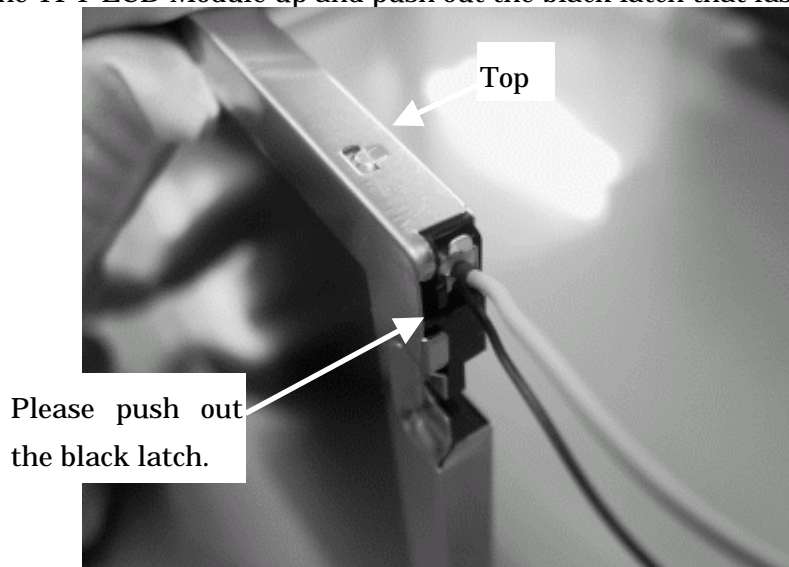

Picture 3

- 4) Pull the cable slowly and remove the Lamp Unit.

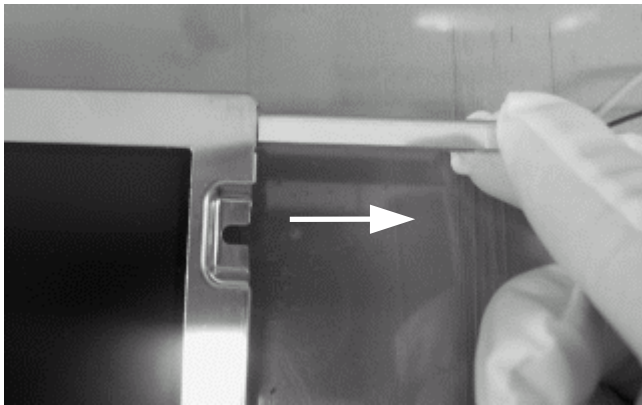

Picture 4

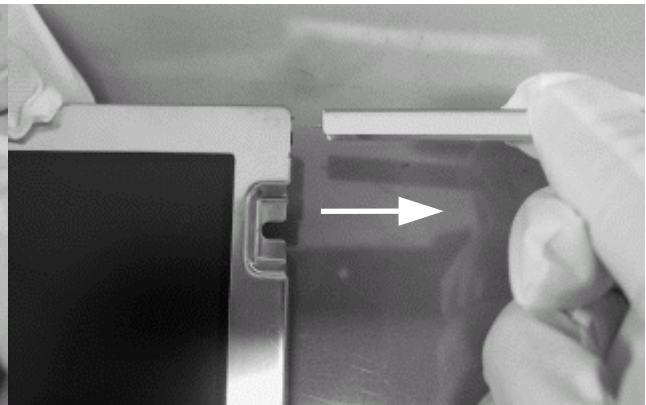

Picture 5

- 5) Remove the other Lamp Unit at the opposite(bottom) side of LCD Module in the same way. See. 3) and 4)
- 6) Picture 6 shows the TFT-LCD Module after removing the Lamp Units.

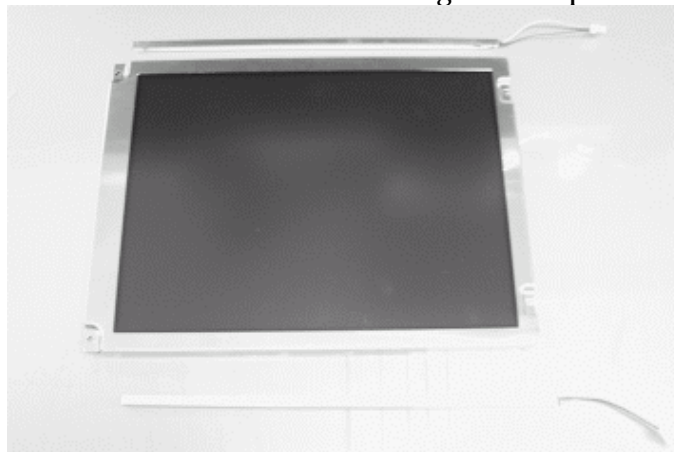

Picture 6

- 7) Prepare to insert the new Lamp Unit.
 - Open the package and take the new Lamp Unit out.
 - Check the new Lamp Unit for dust and foreign matters.
- 8) Stand the TFT-LCD Module up and insert the new Lamp Unit.

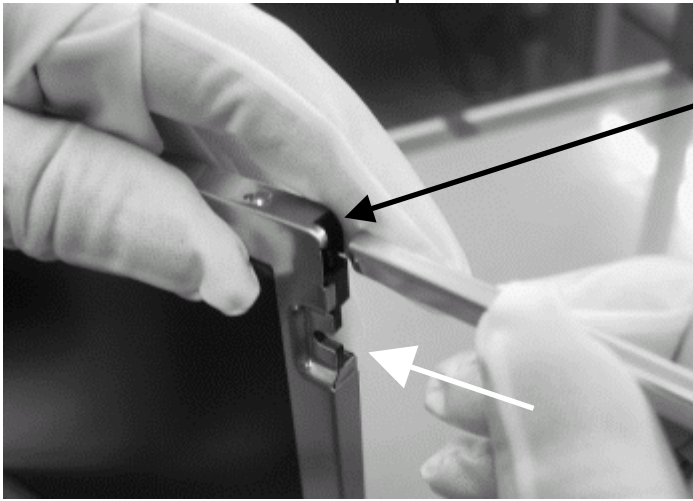

Fold down the black film to keep the end of the black film out. Push the black latch out, and insert the new Lamp Unit. (Set the Lamp opening face down.)

Picture 7

Please do not insert it in the wrong position.

- 9) After inserting, please check the Lamp Unit is fastened by the black latch.

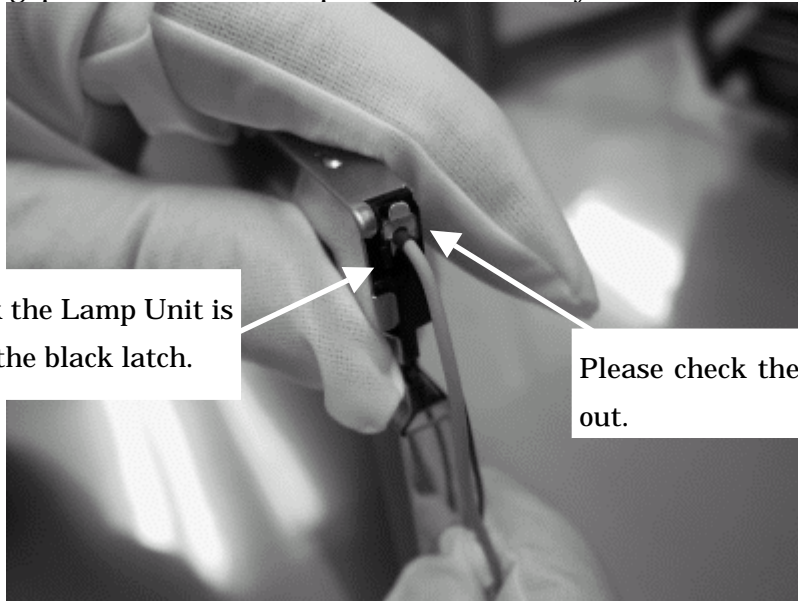

Please check the Lamp Unit is fastened by the black latch.

Please check the black film is out.

Picture 8

- 10) Insert the other Lamp Unit to the opposite(bottom) side of the LCD module in the same way.
See. 8) to 9)
- 11) After replacing the Lamp Unit, please check the following items.
 - Appearance of TFT-LCD Module is not changed after replacing Lamp Unit.
(See. Picture 1 and Picture 2)
 - There is no damage, dust, or foreign matters on the LCD Panel Surface.
 - Install the TFT-LCD Module then check turning on the lamps.