

LCD Module Technical Specification

First Edition
Nov. 05, 2010

Final Revision

Type No. **T-55620GD057JU-LW-AAN**

Customer : **OPTREX STANDARD**

Customer's Product No : -----

OPTREX CORPORATION

Approved: *Yasuo Kawasaki*
QUALITY ASSURANCE DIVISION

Checked: *Hiroyuki Miyanishi*
Product Realization Div.

Prepared: *Hironori Miyano*
Product Realization Div.

APPROVED

By

Signature :

Date :

Please return this specification within two month with your signature.
If not returned within two month, specification will be considered
as having been accepted.

Table of Contents

- 1. Application..... 3
- 2. General Specifications..... 3
- 3. Operating Conditions 3
- 4. Dimensional Outline 4
- 5. Block Diagram..... 5
- 6. I/O Terminal..... 6
- 7. Electrical Specifications..... 8
- 8. Optical Specifications 16
- 9. Test 22
- 10. Appearance Standards..... 23
- 11. Code System of Production Lot 26
- 12. Type Number..... 26
- 13. Applying Precautions 26
- 14. Precautions Relating Product Handling..... 27
- 15. Warranty..... 28

Revision History

Rev.	Date	Page	Comment

1. Application

This specification applies to 5.7" color TFT-LCD module (T-55620GD057JU-LW-AAN).

2. General Specifications

Dot Pixels	:	640×3 [R.G.B] (W) × 480 (H) dots
Dot Size	:	0.06×3 [R.G.B] (W) × 0.18 (H) mm
Pixel Arrangement	:	RGB-Stripe
Color Depth	:	262,144 colors
Viewing Area	:	117.0 (W) × 88.2 (H) mm
Outline Dimensions	:	143.2 (W) × 103.8* (H) × 11.6max. (D) mm * Without LED Cable
Weight	:	180 g max.
LCD Type	:	ATS-26424 (TFT / Normally white-mode / Transmissive)
Viewing Angle	:	12:00 (The Angle of Least Color Inversion)
Interface	:	LVDS(Low Voltage Differential Signaling)
Backlight	:	LED Backlight / White
Lead free	:	Our product corresponds to lead free. Lead free is defined as below: 1) The solder used in the LCD module. 2) Electrical components (Terminal section) used in the LCD module. Any lead used within the electrical component does not apply to our module definition of lead free.
RoHS regulation	:	To our best knowledge, this product satisfies material requirement of RoHS regulation. Our company is doing the best efforts to obtain the equivalent certificate from our suppliers.

3. Operating Conditions

Item	Conditions	Temperature Range	Remark
Operating Temperature Range	Display Surface	-20~70°C	Note1
Storage Temperature Range	Display Surface	-30~80°C	

Note1: Operating temperature range defines the operation only and the contrast, response time and other display optical characteristics are set at Ta=+25°C.

4. Dimensional Outline

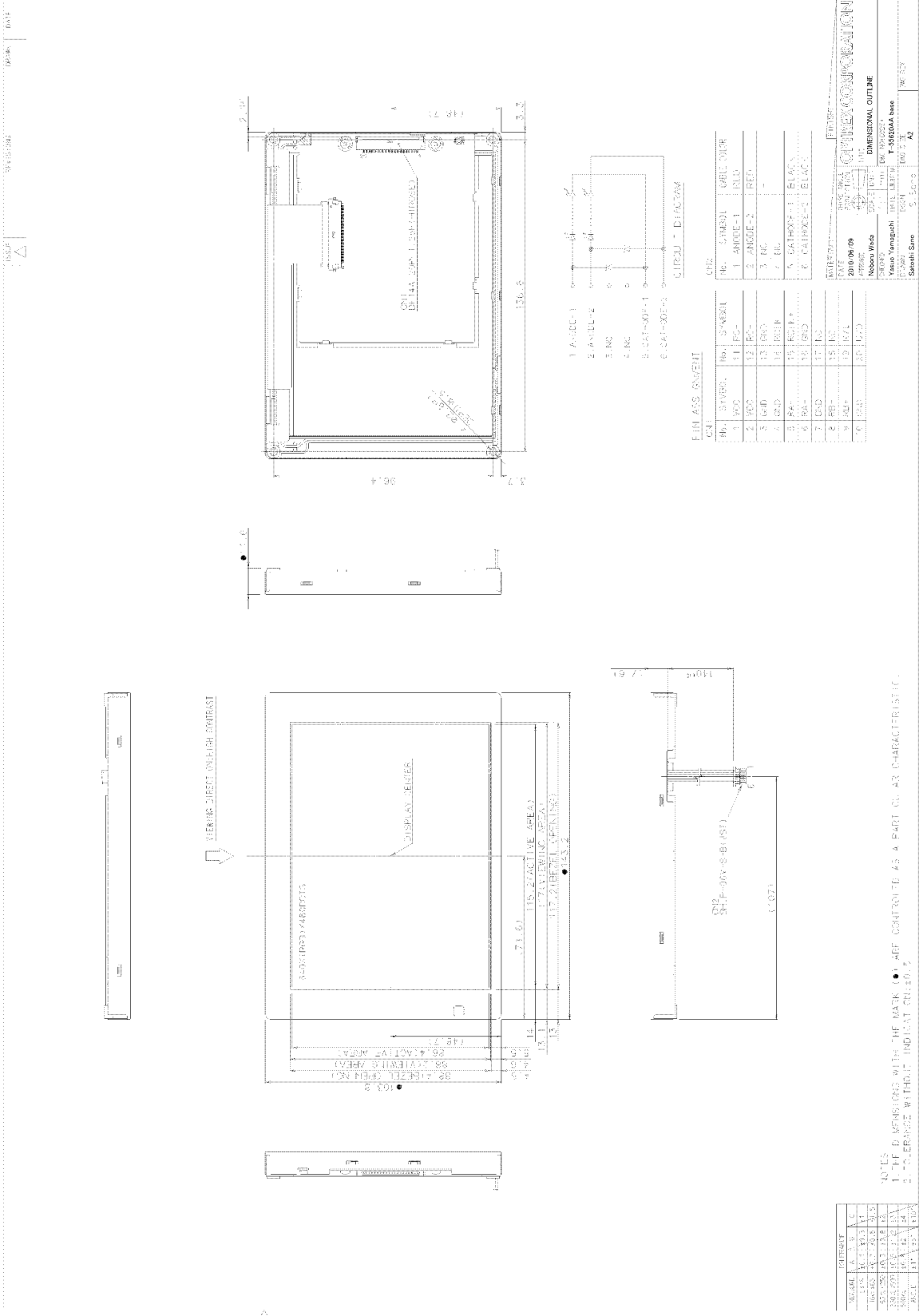

5. Block Diagram

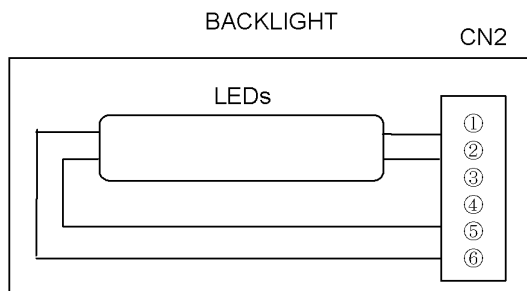
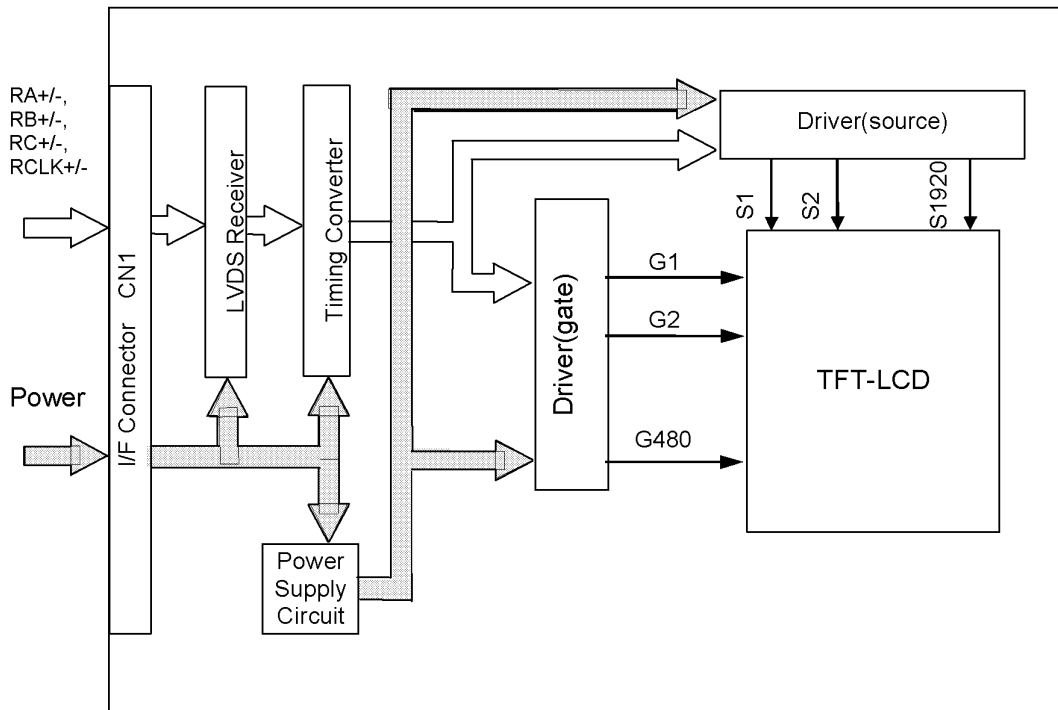

6. I/O Terminal

6.1. CN1 Pin Assignment (INTERFACE SIGNAL)

Used connector DF14A-20P-1.25H(56) (HIROSE)

Corresponding connector DF14-20S-1.25C(HIROSE)

No.	Symbol	Functional Description
1	VCC	Power Supply (DC 3.3V)
2	VCC	Power Supply (DC 3.3V)
3	GND	Power Supply (0V, GND)
4	GND	Power Supply (0V, GND)
5	RA-	LVDS Data Input R0, R1, R2, R3, R4, R5, G0
6	RA+	LVDS Data Input R0, R1, R2, R3, R4, R5, G0
7	GND	Power Supply (0V, GND)
8	RB-	LVDS Data Input G1, G2, G3, G4, G5, B0, B1
9	RB+	LVDS Data Input G1, G2, G3, G4, G5, B0, B1
10	GND	Power Supply (0V, GND)
11	RC-	LVDS Data Input B2, B3, B4, B5, HS, VS, DEN
12	RC+	LVDS Data Input B2, B3, B4, B5, HS, VS, DEN
13	GND	Power Supply (0V, GND)
14	RCLK-	LVDS Clock Input
15	RCLK+	LVDS Clock Input
16	GND	Power Supply (0V, GND)
17	NC	Non Connection
18	NC	Non Connection
19	R/L	Control the shift direction of device internal shift resistor
20	U/D	Set the Up/Down scan direction

6.2. CN2 Pin Assignment (Backlight)

Used connector : SHLP-06V-S-B(JST)

Corresponding connector : SM06B-SHLS-TF(LF)(SN) (JST)

No.	Symbol	Functional Description
1	Anode-1	CABLE COLOR RED
2	Anode-2	CABLE COLOR RED
3	NC	Non-Connection
4	NC	Non-Connection
5	Cathode 1	CABLE COLOR BLACK
6	Cathode 2	CABLE COLOR BLACK

6.3.ISP data mapping

a. ISP 6 bit compatibility mode (6 bit input)

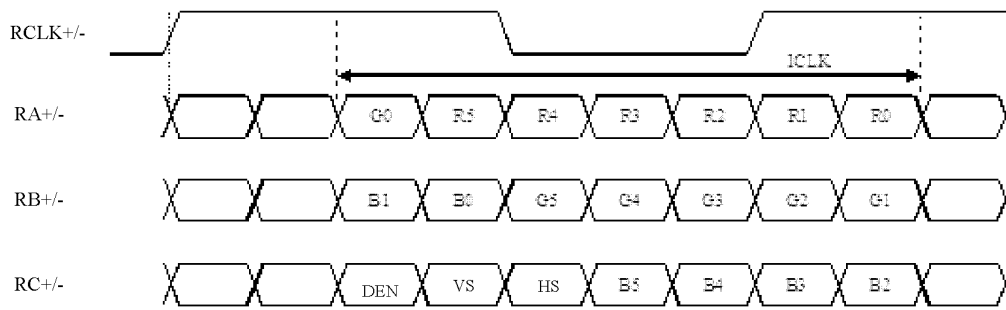

7. Electrical Specifications

7.1. Absolute Maximum Ratings

Ta=-20~70°C, VSS=0V

Parameter	Symbol	Conditions	Min.	Max.	Units
Supply Voltage for LCD	VCC	-	-0.3	4.0	V

7.2. DC Characteristics

Ta=-20~70°C, VSS=0V

Parameter	Symbol	Min.	Typ.	Max.	Units
Supply Voltage for LCD	VCC	3.0	3.3	3.6	V
High Level Input Voltage	V _{IH}	2.0	-	VCC	V
Low Level Input Voltage	V _{IL}	0	-	0.8	V
Power Supply Current for LCD	ICC	-	TBD	TBD	mA

A) Typical current condition

All black pattern with frame 480 line mode.

VCC=+3.3V, f_H=31.468kHz, f_V=59.59Hz, f_{CLK}=25.175MHz

7.3.Interface Timing

7.3.1.Digital Parallel RGB Interface Timing

Ta=-20~70°C, VCC=3.0~3.6V

Parameter	Symbol	Min.	Typ.	Max.	Units
CK Frequency	1/tCK	22.66	25.175	27.69	MHz
CK Period	tCK	36.11	39.7	44.13	ns
CK Pulse Duty	tCKH / (tCKH+ tCKL)	40	50	60	%
HSYC Setup Time	tHST	10	-	-	ns
HSYC Hold Time	tHHT	10	-	-	ns
HSYC Period	tH	750	800	850	tCK
HSYC Pulse Width	tWH	5	30	-	tCK
HSYC Back Porch	tHB	112	144	175	tCK
HSYC Display Term	tHD	-	640	-	tCK
VSYC Setup Time	tVST	10	-	-	ns
VSYC Hold Time	tVHT	10	-	-	ns
VSYC Period	tV	515	525	535	tH
VSYC Pulse Width	tWV	1	3	5	tH
VSYC Back Porch	tVB	5	35	-	tH
VSYC Display Term	tVD	-	480	-	tH
ENAB Setup Time	tDST	10	-	-	ns
ENAB Pulse Width	tEP	-	640	-	tCK
ENAB Frame Active time	tDEA	-	480	-	tH
Data Setup Time	tDST	10	-	-	ns
Data Hold Time	tDHT	10	-	-	ns

Note

1) LVDS timing follows the timing specifications of LVDS receiver IC:THC63LVDF84B(Thine).

7.3.2. Timing Chart

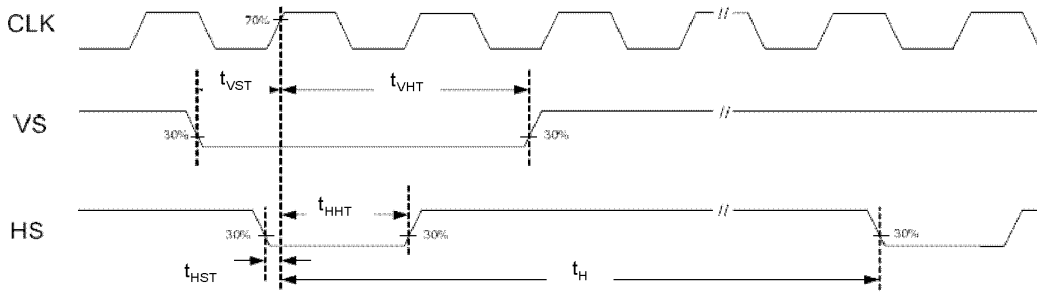
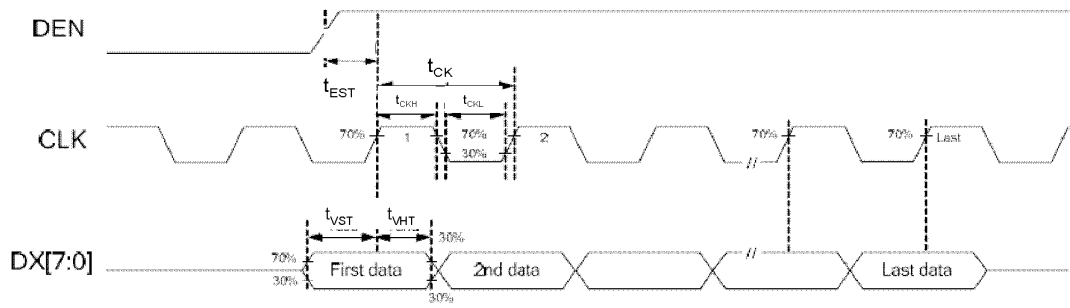

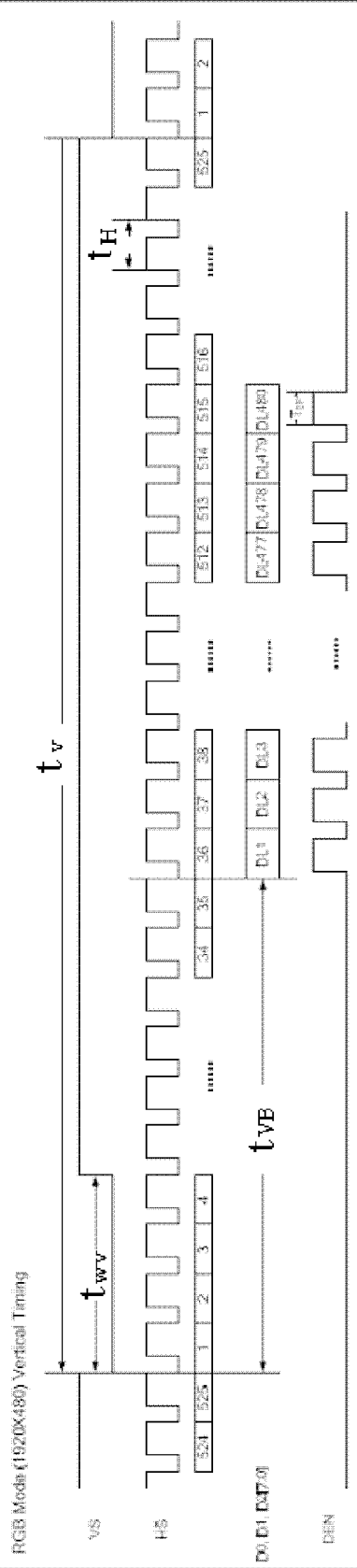

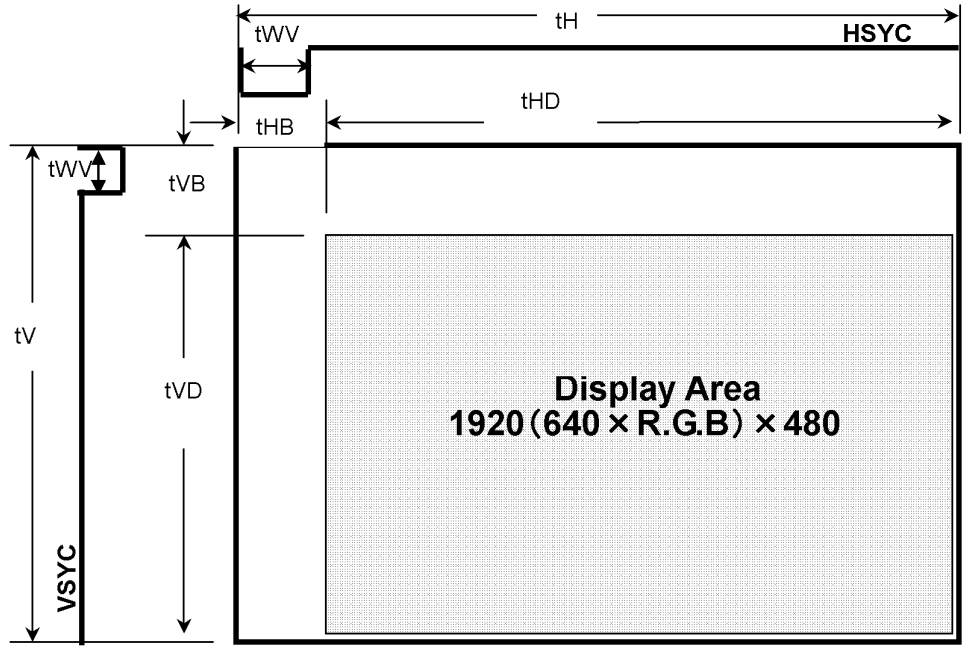

7.4.Pixel Alignment

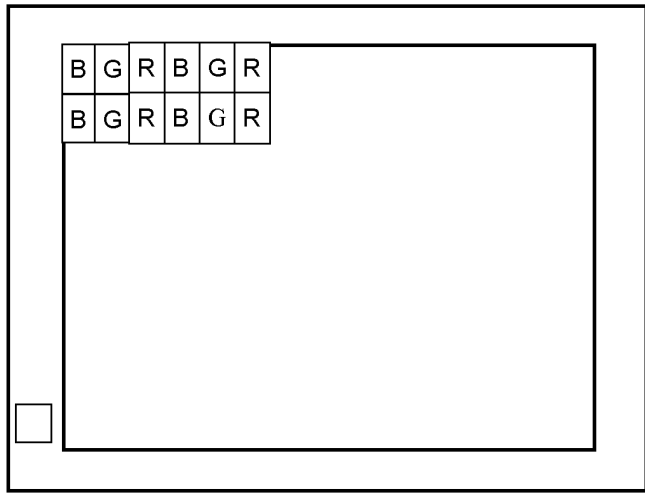

7.5.Color Data Assignment

COLOR	INPUT DATA	R DATA						G DATA						B DATA					
		MSB			LSB			MSB			LSB			MSB			LSB		
		R5	R4	R3	R2	R1	R0	G5	G4	G3	G2	G1	G0	B5	B4	B3	B2	B1	B0
BASIC COLOR	BLACK	0	0	0	0	0	0	0	0	0	0	0	0	0	0	0	0	0	0
	RED (63)	1	1	1	1	1	1	0	0	0	0	0	0	0	0	0	0	0	0
	GREEN (63)	0	0	0	0	0	0	1	1	1	1	1	1	0	0	0	0	0	0
	BLUE (63)	0	0	0	0	0	0	0	0	0	0	0	0	1	1	1	1	1	1
	CYAN	0	0	0	0	0	0	1	1	1	1	1	1	1	1	1	1	1	1
	MAGENTA	1	1	1	1	1	1	0	0	0	0	0	0	1	1	1	1	1	1
	YELLOW	1	1	1	1	1	1	1	1	1	1	1	1	0	0	0	0	0	0
	WHITE	1	1	1	1	1	1	1	1	1	1	1	1	1	1	1	1	1	1
RED	RED (0)	0	0	0	0	0	0	0	0	0	0	0	0	0	0	0	0	0	0
	RED (1)	0	0	0	0	0	1	0	0	0	0	0	0	0	0	0	0	0	0
	RED (2)	0	0	0	0	1	0	0	0	0	0	0	0	0	0	0	0	0	0
	RED (62)	1	1	1	1	1	0	0	0	0	0	0	0	0	0	0	0	0	0
	RED (63)	1	1	1	1	1	1	0	0	0	0	0	0	0	0	0	0	0	0
GREEN	GREEN (0)	0	0	0	0	0	0	0	0	0	0	0	0	0	0	0	0	0	0
	GREEN (1)	0	0	0	0	0	0	0	0	0	0	0	1	0	0	0	0	0	0
	GREEN (2)	0	0	0	0	0	0	0	0	0	0	1	0	0	0	0	0	0	0
	GREEN (62)	0	0	0	0	0	0	1	1	1	1	1	0	0	0	0	0	0	0
GREEN (63)	0	0	0	0	0	0	1	1	1	1	1	1	0	0	0	0	0	0	
BLUE	BLUE (0)	0	0	0	0	0	0	0	0	0	0	0	0	0	0	0	0	0	0
	BLUE (1)	0	0	0	0	0	0	0	0	0	0	0	0	0	0	0	0	0	1
	BLUE (2)	0	0	0	0	0	0	0	0	0	0	0	0	0	0	0	0	1	0
	BLUE (62)	0	0	0	0	0	0	0	0	0	0	0	0	1	1	1	1	1	0
BLUE (63)	0	0	0	0	0	0	0	0	0	0	0	0	1	1	1	1	1	1	

[Note]

- 1) Definition of gray scale
Color (n) --- n indicates gray scale level.
Higher n means brighter level.

2) R Data 1:High, 0: Low
 Relation of IC and LCD Module Data Bus

LCD Module	R5	R4	R3	R2	R1	R0	GND	GND
IC	D07	D06	D05	D04	D03	D02	D01*	D00*

*Connected to "L" in the LCD Module

3) G Data 1:High, 0: Low

LCD Module	G5	G4	G3	G2	G1	G0	GND	GND
IC	D17	D16	D15	D14	D13	D102	D11	D10

4) B Data 1:High, 0: Low

LCD Module	B5	B4	B3	B2	B1	B0	GND	GND
IC	D27	D26	D25	D24	D23	D22	D21	D20

7.6. Inverted Scan Capability

This module has the capability of inverting scan direction by signaling from controller.
 Note that scan direction cannot be changed during operation.

The following drawing shows the relationship between the viewing direction and the scan direction.

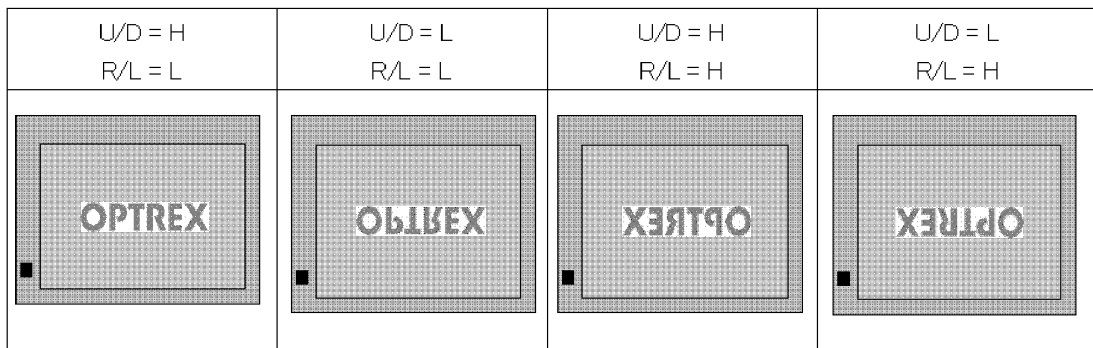

7.7. Lighting Specifications

7.7.1. Absolute Maximum Ratings

Ta=25°C

Parameter	Symbol	Conditions	Min.	Typ.	Max.	Units
Forward Current	IF	Note1	-	80	150	mA
Forward Voltage	VF	IF=80mA / 1 line	-	(16.0)	-	V
Power	PL	IF=80mA / 1 line		1.28	2.7	W
LED Life cycle	-	IF=80mA / 1 line			*(50,000)	Hr

(*B/L Life cycle: The point that became 40% or less of initial brightness is assumed to be longevity.)

【Forward Current Derating Curve】

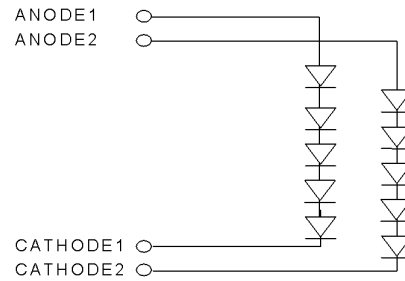
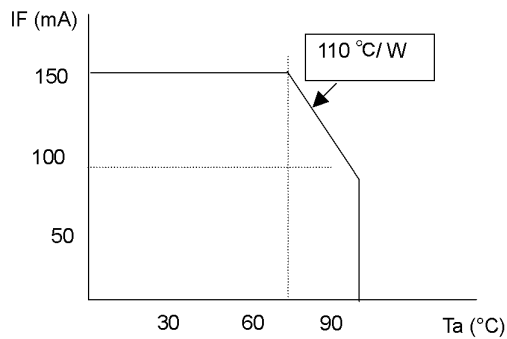

Note1: Current of LED par chip must be lower than 150mA at 70 degC.

The current of LED must be tuned to satisfy as Forward Current Derating Curve mentioned relationship

8. Optical Specifications

8.1. Optical Characteristics

Item	Symbol	Conditions			Standard Value			Unit	Method of Measure	Remark
		θ	ϕ	C	Min.	Typ.	Max.			
Brightness	B	0°	0°	/	280	500	-	cd/m ²	Note1	
Contrast	CR	Best Viewing			150	(500)	-	-		
Color Coordinates	Red	Rx	0°	0°	/	-	(0.611)	-		-
		Ry	0°	0°	/	-	(0.360)	-		-
	Green	Gx	0°	0°	/	-	(0.358)	-		-
		Gy	0°	0°	/	-	(0.567)	-		-
	Blue	Bx	0°	0°	/	-	(0.147)	-		-
		By	0°	0°	/	-	(0.101)	-		-
	White	Wx	0°	0°	/	-	(0.329)	-		-
		Wy	0°	0°	/	-	(0.339)	-		-
Brightness Uniformity	-	0°	0°	/	60	65	-	%		(Fig.2)
Vertical Viewing Angle	Up	θ_U	-	90°	≥ 5	-	70	-		Degree
	Down	θ_D	-	270°	≥ 5	-	70	-		Degree
Horizontal Viewing Angle	Left	ϕ_L	180°	-	≥ 5	-	70	180°		Degree
	Right	ϕ_R	0°	-	≥ 5	-	70	0°	Degree	
Response Time	Rise	τ_r	0°	0°	/	-	TBD	-	ms	
	Decay	τ_d	0°	0°	/	-	TBD	-	ms	

Note1: Under the condition of maximum brightness.

◆ Conditions for Measuring

- ◇ Environment: Dark room with no light or close to no light.
- ◇ Temperature: 25±5°C
- ◇ Humidity: 40~70%RH
- ◇ Driving voltage is set for optimal contrast to measure center of display.
- ◇ LED Backlight driving condition: IF =80.0 (mA)

◆ Optimal viewing angle

(The angle of Least Color Inversion)

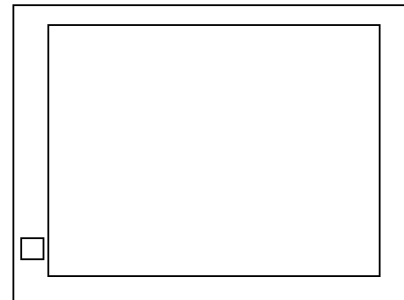
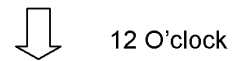



8.2. Definition of Viewing Angle and Optimum Viewing Area

*Point ● shows the point where contrast ratio is measured. : $\theta = 0^\circ$, $\phi = 0^\circ$

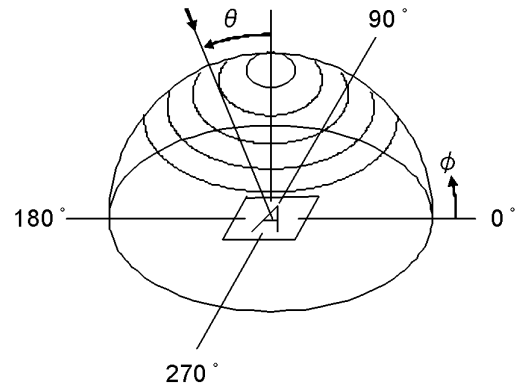
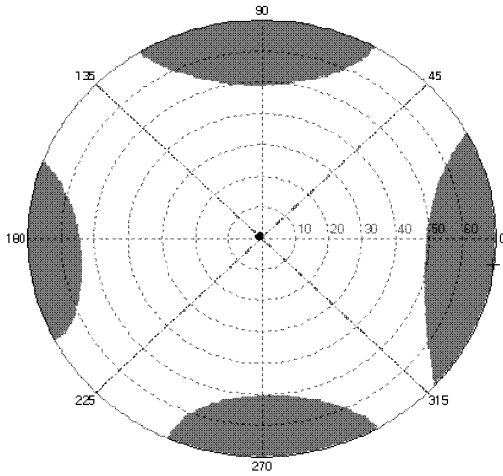
*Driving condition: $F_r = 60\text{Hz}$



*Area  shows typ. $CR \geq 30$

*Area  shows typ. $CR \leq 30$

◆ Method of Brightness Measurement (Fig.1)

(1) Measuring Device

TOPCON: BM-5

(2) Measuring Point

Center of Display: $\theta=0^\circ$, $\phi=0^\circ$

On condition θ : A vertical angle from measuring direction to perpendicular.

ϕ : A horizontal angle from measuring direction to perpendicular.

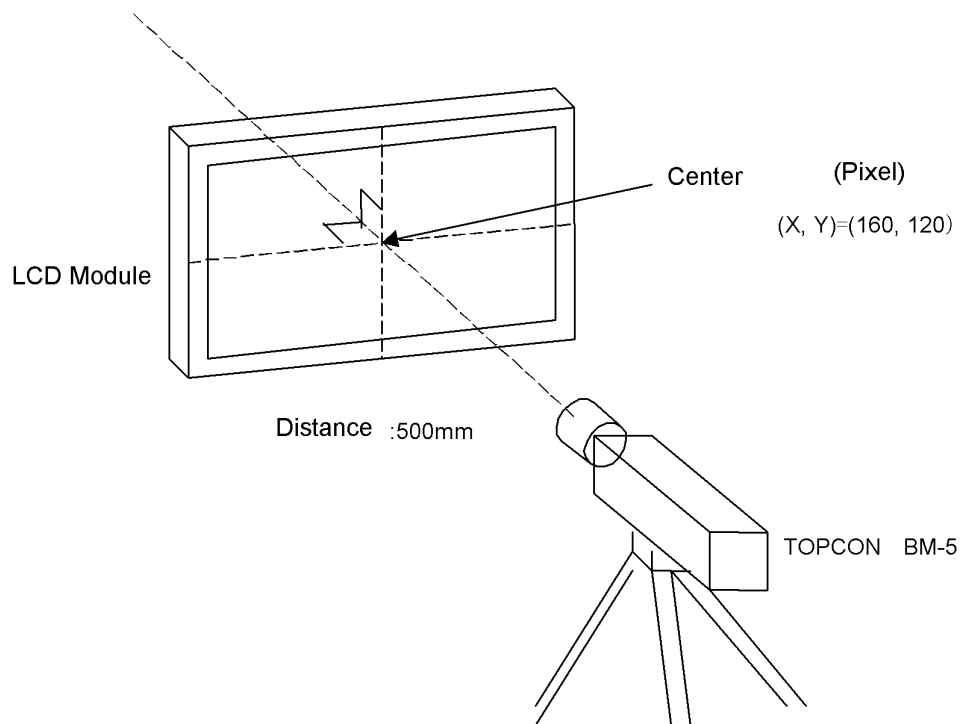

Fig. 1

(3) Method of Measuring

Apply signal voltage (displayed in white) to maximize brightness and measure brightness B (cd/m^2).

The distance between BM-5's front lens to surface panel is 500mm.

Measured after backlight has been lit for more than 30 minutes.

◆ Method of Contrast Measurement (Fig.1)

(1) Measuring Device

TOPCON: BM-5, Measuring Field: 1°

(2) Measuring Point

Center of display: same as Method of Brightness Measurement

(3) Method of Measuring

• Set LCD module to $\theta=0^\circ$, $\phi=0^\circ$.

• Change signal voltage to measure maximum brightness $Y1$ and minimum brightness $Y2$.

• Contrast is derived from $CR=Y1/Y2$.

◆ Definition of Brightness Uniformity (Fig.2)

Definition is calculated from the four points (S1-S9) on the diagram below.

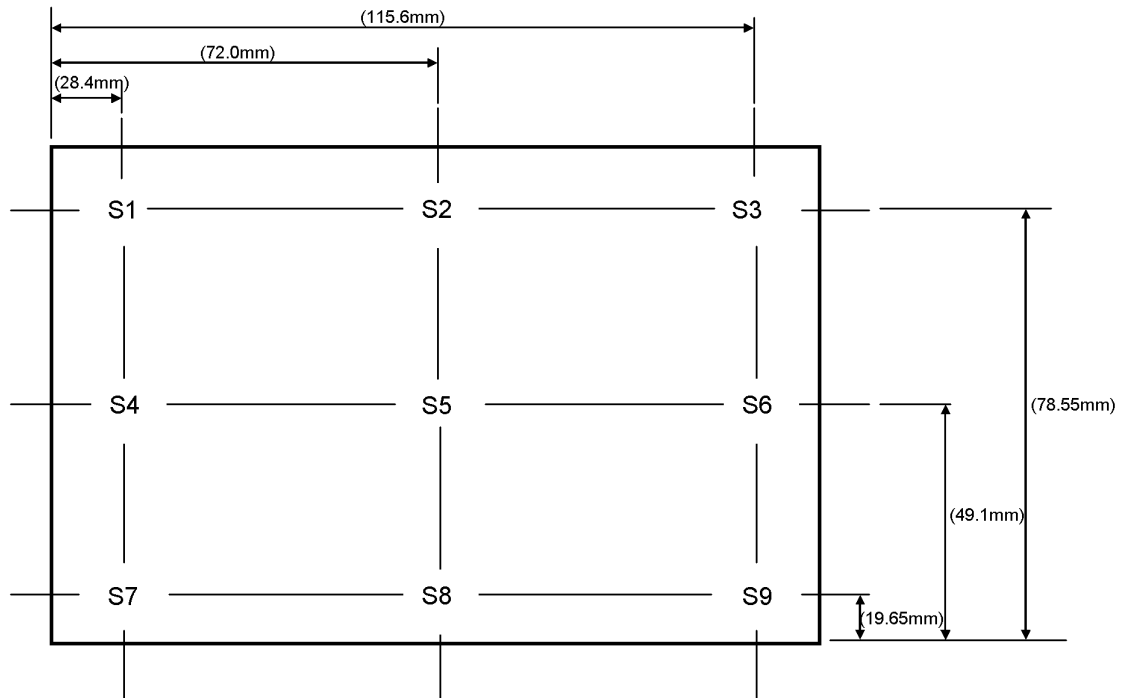

$$\text{Standard Value of Brightness Uniformity[\%]} = \frac{\text{Minimum Value of S1-S9}}{\text{Maximum Value of S1-S9}} \times 100$$

Fig. 2

◆ Method of Viewing Angle Measurement (Fig.3)

(1) Measuring Device

ELDIM: EZ CONTRAST

(2) Measuring Point

Center of display: Same as Method of Brightness Measurement

(3) Angle of Measuring

θ : An angle vertical to perpendicular line from the viewing direction.

ϕ : An angle horizontal to perpendicular from the viewing direction.

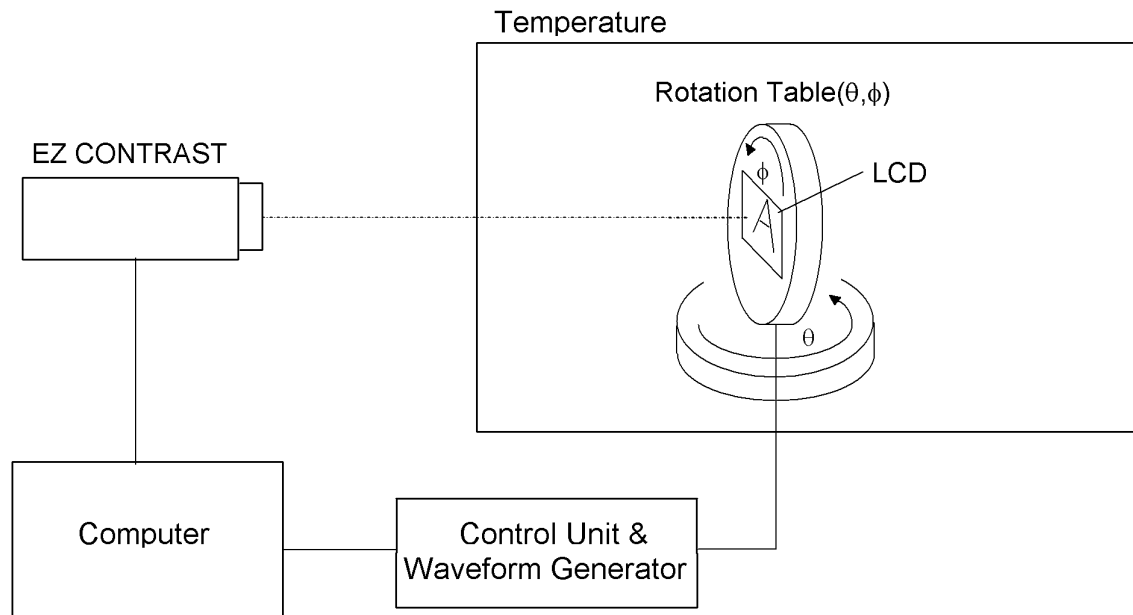

Fig. 3

(4) Method of Measuring

Set the module on the rotation table and measure a vertical axis direction in the state that fixed $\phi = 0$ degrees horizontal axis direction to $\theta = 90$ degrees.

(Viewing angle is measured automatically by EZ CONTRAST)

◆ Measuring Response Time (Fig.4)

(1) Measuring Device

TOPCON BM-5, Measuring Field: 1°

Tektronix Digital Oscilloscope

(2) Measuring Point

Center of display, same as Method of Brightness Measurement

(3) Method of Measuring

- Set LCD panel to $\theta=0^\circ$, and $\phi=0^\circ$.
- Input white→black→white to display by switching signal voltage.
- If the luminance is 0% and 100% immediately before the change of signal voltage, then τ_r is optical response time during the change from 90% to 10% immediately after rise of signal voltage, and τ_d is optical response time during the change from 10% to 90% immediately after decay of signal voltage.

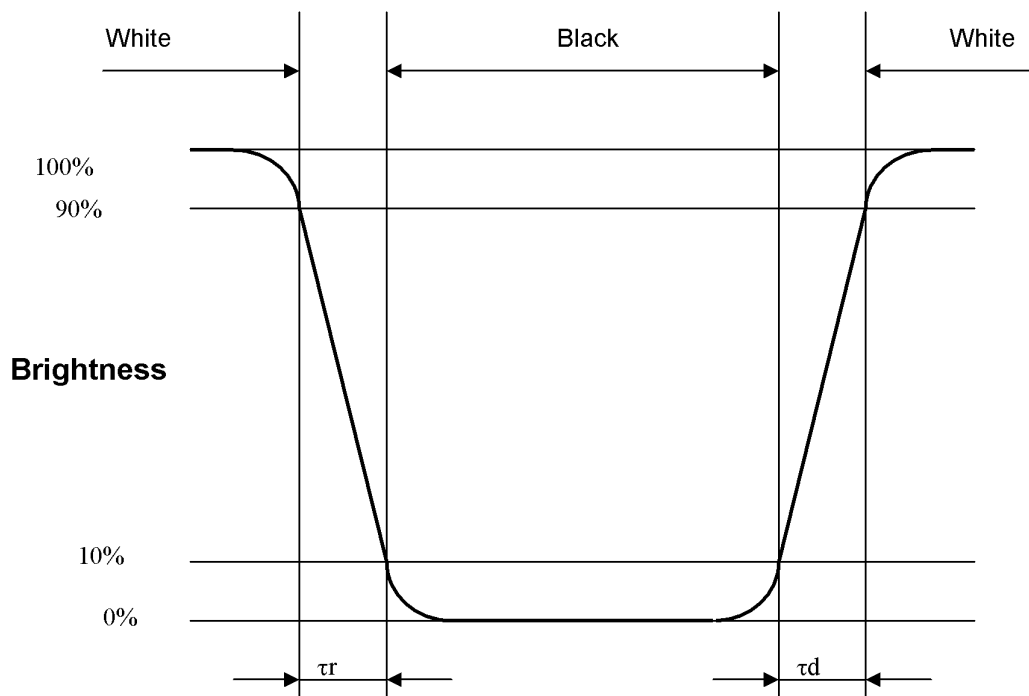

Fig. 4

9. Test

No abnormal function and appearance are found after the following tests.

Conditions: Unless otherwise specified, tests will be conducted under the following condition.

Temperature: $20 \pm 5^\circ\text{C}$

Humidity : $65 \pm 5\% \text{RH}$

tests will not be conducted under functioning state.

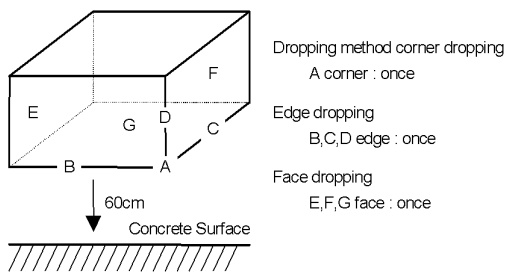
No.	Parameter	Conditions	Notes
1	High Temperature Operating	$70^\circ\text{C} \pm 2^\circ\text{C}$, 96hrs (operation state)	
2	Low Temperature Operating	$-20^\circ\text{C} \pm 2^\circ\text{C}$, 96hrs (operation state)	1
3	High Temperature Storage	$80^\circ\text{C} \pm 2^\circ\text{C}$, 96hrs	2
4	Low Temperature Storage	$-30^\circ\text{C} \pm 2^\circ\text{C}$, 96hrs	1,2
5	Damp Proof Test	$40^\circ\text{C} \pm 2^\circ\text{C}$, 90%RH, 96hrs	1,2
6	Vibration Test	Total fixed amplitude : 1.5mm Vibration Frequency : 10~55Hz One cycle 60 seconds to 3 directions of X, Y, Z each 15 minutes	3
7	Shock Test	To be measured after dropping from 60cm high the concrete surface in packing state. 	

Note 1 :No dew condensation to be observed.

Note 2 :The function test shall be conducted after 4 hours storage at the normal Temperature and humidity after removed from the test chamber.

Note 3 :Vibration test will be conducted to the product itself without putting it in a container.

10. Appearance Standards

10.1. Inspection conditions

The LCD shall be inspected under the white fluorescent light.

Appearance Inspection: Illuminans > 500 [lx]

Operating Inspection: Illuminance < 250 [lx]

The distance between the eyes and the sample shall be more than 30cm.

All directions for inspecting the sample should be within 45° against perpendicular line.

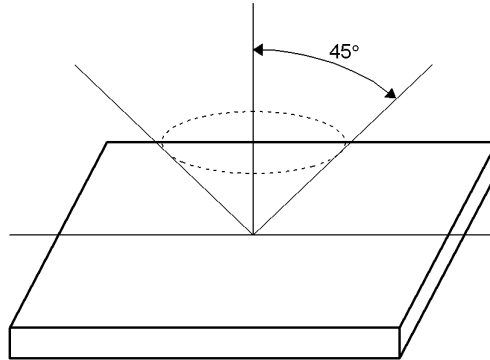

10.2. Definition of applicable Zones

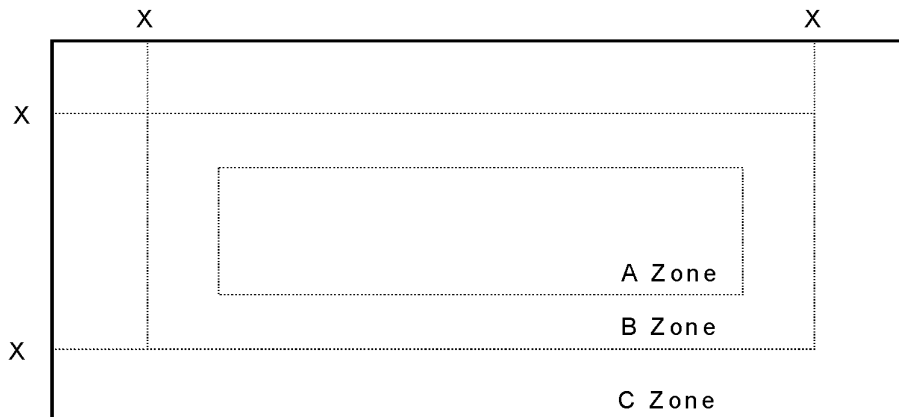

X : Metal Holder Opening

A Zone: Active display area

B Zone = (Viewing Area) – (Active Area)

C Zone: Rest parts

10.3. Standards (Only the display part)

No.	Parameter	Criteria																												
1	Polarizer Scratches	<table border="1"> <thead> <tr> <th colspan="2" rowspan="2">Zone</th> <th colspan="3">Acceptable Number</th> </tr> <tr> <th>A</th> <th>B</th> <th>C</th> </tr> </thead> <tbody> <tr> <td>X(mm)</td> <td>Y(mm)</td> <td></td> <td></td> <td></td> </tr> <tr> <td>$L \leq 15$</td> <td>$0.01 < W \leq 0.05$</td> <td colspan="2">4</td> <td>*</td> </tr> <tr> <td>$L > 15$</td> <td>$W > 0.01$</td> <td colspan="2">0</td> <td>*</td> </tr> <tr> <td>-</td> <td>$W > 0.05$</td> <td colspan="2">0</td> <td>*</td> </tr> </tbody> </table> <p>X : Length, Y : Width * : Disregard</p>	Zone		Acceptable Number			A	B	C	X(mm)	Y(mm)				$L \leq 15$	$0.01 < W \leq 0.05$	4		*	$L > 15$	$W > 0.01$	0		*	-	$W > 0.05$	0		*
Zone		Acceptable Number																												
		A	B	C																										
X(mm)	Y(mm)																													
$L \leq 15$	$0.01 < W \leq 0.05$	4		*																										
$L > 15$	$W > 0.01$	0		*																										
-	$W > 0.05$	0		*																										
2	DENT	<table border="1"> <thead> <tr> <th colspan="2" rowspan="2">Zone</th> <th colspan="3">Acceptable Number</th> </tr> <tr> <th>A</th> <th>B</th> <th>C</th> </tr> </thead> <tbody> <tr> <td colspan="2">Dimension (mm)</td> <td></td> <td></td> <td></td> </tr> <tr> <td colspan="2">$0.30 < D \leq 0.50$</td> <td colspan="2">4</td> <td>*</td> </tr> <tr> <td colspan="2">$0.50 < D$</td> <td colspan="2">0</td> <td>*</td> </tr> </tbody> </table> <p>D : Average Diameter = (long+short)/2 * : Disregard</p>	Zone		Acceptable Number			A	B	C	Dimension (mm)					$0.30 < D \leq 0.50$		4		*	$0.50 < D$		0		*					
Zone		Acceptable Number																												
		A	B	C																										
Dimension (mm)																														
$0.30 < D \leq 0.50$		4		*																										
$0.50 < D$		0		*																										
3	BLACK SPOT WHITE SPOT BUBBLE	<table border="1"> <thead> <tr> <th colspan="2" rowspan="2">Zone</th> <th colspan="3">Acceptable Number</th> </tr> <tr> <th>A</th> <th>B</th> <th>C</th> </tr> </thead> <tbody> <tr> <td colspan="2">Dimension (mm)</td> <td></td> <td></td> <td></td> </tr> <tr> <td colspan="2">$0.30 < D \leq 0.50$</td> <td colspan="2">5</td> <td>*</td> </tr> <tr> <td colspan="2">$0.50 < D$</td> <td colspan="2">0</td> <td>*</td> </tr> </tbody> </table>	Zone		Acceptable Number			A	B	C	Dimension (mm)					$0.30 < D \leq 0.50$		5		*	$0.50 < D$		0		*					
Zone		Acceptable Number																												
		A	B	C																										
Dimension (mm)																														
$0.30 < D \leq 0.50$		5		*																										
$0.50 < D$		0		*																										
4	LINT	<table border="1"> <thead> <tr> <th colspan="2" rowspan="2">Zone</th> <th colspan="3">Acceptable Number</th> </tr> <tr> <th>A</th> <th>B</th> <th>C</th> </tr> </thead> <tbody> <tr> <td>X(mm)</td> <td>Y(mm)</td> <td></td> <td></td> <td></td> </tr> <tr> <td>$L \leq 3.0$</td> <td>$W \leq 0.15$</td> <td colspan="2">4</td> <td>*</td> </tr> <tr> <td>$L > 3.0$</td> <td>$W \leq 0.15$</td> <td colspan="2">0</td> <td>*</td> </tr> <tr> <td>-</td> <td>$W > 0.15$</td> <td colspan="2">According to BLACK SPOT</td> <td>*</td> </tr> </tbody> </table> <p>X : Length, Y : Width * : Disregard</p>	Zone		Acceptable Number			A	B	C	X(mm)	Y(mm)				$L \leq 3.0$	$W \leq 0.15$	4		*	$L > 3.0$	$W \leq 0.15$	0		*	-	$W > 0.15$	According to BLACK SPOT		*
Zone		Acceptable Number																												
		A	B	C																										
X(mm)	Y(mm)																													
$L \leq 3.0$	$W \leq 0.15$	4		*																										
$L > 3.0$	$W \leq 0.15$	0		*																										
-	$W > 0.15$	According to BLACK SPOT		*																										

No.	Parameter	Criteria																							
5	(a) Bright Dot	<table border="1"> <thead> <tr> <th colspan="2" rowspan="2">Zone</th> <th colspan="3">Acceptable Number</th> </tr> <tr> <th>A</th> <th>B</th> <th>C</th> </tr> </thead> <tbody> <tr> <td>Bright Dot</td> <td>Note1</td> <td colspan="2">4</td> <td>*</td> </tr> <tr> <td>Dark Dot</td> <td>Note2</td> <td colspan="2">5</td> <td>*</td> </tr> <tr> <td colspan="2">TOTAL</td> <td colspan="3">5</td> </tr> </tbody> </table> <p>* : Disregard</p>	Zone		Acceptable Number			A	B	C	Bright Dot	Note1	4		*	Dark Dot	Note2	5		*	TOTAL		5		
	Zone				Acceptable Number																				
			A	B	C																				
	Bright Dot		Note1	4		*																			
	Dark Dot	Note2	5		*																				
TOTAL		5																							
(b) Dark Dot																									
Dot Defect	(c) TWO Adjacent Dot	<table border="1"> <thead> <tr> <th colspan="2" rowspan="2">Zone</th> <th colspan="3">Acceptable Number</th> </tr> <tr> <th>A</th> <th>B</th> <th>C</th> </tr> </thead> <tbody> <tr> <td>Bright Dot</td> <td>Note1,3</td> <td colspan="2">2 PAIRS</td> <td>*</td> </tr> <tr> <td>Dark Dot</td> <td>Note2,3</td> <td colspan="2">3 PAIRS</td> <td>*</td> </tr> </tbody> </table> <p>* : Disregard</p>	Zone		Acceptable Number			A	B	C	Bright Dot	Note1,3	2 PAIRS		*	Dark Dot	Note2,3	3 PAIRS		*					
	Zone				Acceptable Number																				
A			B	C																					
Bright Dot	Note1,3	2 PAIRS		*																					
Dark Dot	Note2,3	3 PAIRS		*																					
(d) Three or More Adjacent Dot	NOT ALLOWED																								
(e) Distance	<table border="1"> <thead> <tr> <th colspan="2" rowspan="2">Zone</th> <th colspan="3">Acceptable Level</th> </tr> <tr> <th>A</th> <th>B</th> <th>C</th> </tr> </thead> <tbody> <tr> <td>Bright Dot</td> <td></td> <td colspan="2">5 mm \leq</td> <td>*</td> </tr> <tr> <td>Dark Dot</td> <td></td> <td colspan="2">5 mm \leq</td> <td>*</td> </tr> </tbody> </table> <p>* : Disregard</p>	Zone		Acceptable Level			A	B	C	Bright Dot		5 mm \leq		*	Dark Dot		5 mm \leq		*						
Zone				Acceptable Level																					
		A	B	C																					
Bright Dot		5 mm \leq		*																					
Dark Dot		5 mm \leq		*																					
6	Line Defect	NOT ALLOWED																							

Note 1: Bright Dot is defined as follows:

Visible through 5% transmission ND filter under the condition that black image (color 0) is on the display.

Note 2: Dark Dot is defined as follows:

Recognizable darker than around under the condition that each R(63), G(63), B(63) image is on the display.

Note 3: Definition of adjacent

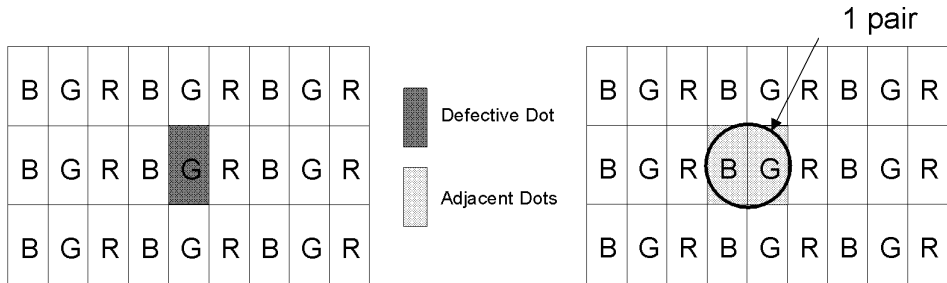

11. Code System of Production Lot

The production lot of module is specified as follows.

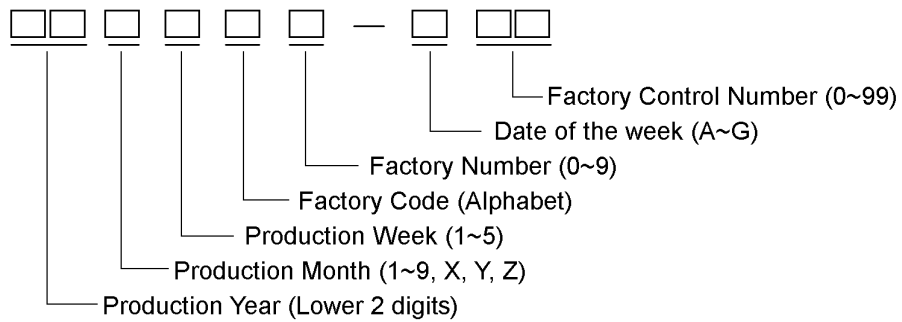

12. Type Number

The type number of module is specified as follows.

355620AA

13. Applying Precautions

Please contact us when questions and/or new problems not specified in this Specifications arise.

14. Precautions Relating Product Handling

The Following precautions will guide you in handling our product correctly.

- 1) Liquid crystal display devices
 - (1) The liquid crystal display panel used in the liquid crystal display module is made of plate glass. Avoid any strong mechanical shock. Should the glass break handle it with care. The polarizer adhering to the surface of the LCD is made of a soft material. Guard against scratching it.
- 2) Care of the liquid crystal display module against static electricity discharge.
 - (1) When working with the module, be sure to ground your body and any electrical equipment you may be using. We strongly recommend the use of anti static mats (made of rubber), to protect worktables against the hazards of electrical shock.
 - (2) Avoid the use of work clothing made of synthetic fibers. We recommend cotton clothing or other conductivity-treated fibers.
 - (3) Slowly and carefully remove the protective film from the LCD module, since this operation can generate static electricity.
- 3) When the LCD module must be stored for long periods of time:
 - (1) Protect the modules from high temperature and humidity.
Conditions: Temperature: 0°C~40°C
 Humidity : Less than 60%RH
 No dew condensation to be observed.
 - (2) Keep the modules out of direct sunlight or direct exposure to ultraviolet rays.
 - (3) Protect the modules from excessive external forces.
- 4) Use the module with a power supply that is equipped with an overcurrent protector circuit, since the module is not provided with this protective feature.
- 5) Do not ingest the LCD fluid itself should it leak out of a damaged LCD module. Should hands or clothing come in contact with LCD fluid, wash immediately with soap.
- 6) Conductivity is not guaranteed for models that use metal holders where solder connections between the metal holder and the PCB are not used. Please contact us to discuss appropriate ways to assure conductivity.
- 7) For models which use COG, TAB, or COF:
 - (1) The mechanical strength of the product is low since the IC chip faces out unprotected from the rear. Be sure to protect the rear of the IC chip from external forces.
 - (2) Given the fact that the rear of the IC chip is left exposed, in order to protect the unit from electrical damage, avoid installation configurations in which the rear of the IC chip runs the risk of making any electrical contact.
- 8) Models which use flexible cable, heat seal, or TAB:
 - (1) In order to maintain reliability, do not touch or hold by the connector area.
 - (2) Avoid any bending, pulling, or other excessive force, which can result in broken connections.
- 9) In case of buffer material such as cushion / gasket is assembled into LCD module, it may have an adverse effect on connecting parts (LCD panel-TCP / HEAT SEAL / FPC / etc., PCB-TCP / HEAT SEAL / FPC etc., TCP-HEAT SEAL, TCP-FPC, HEAT SEAL-FPC, etc.,) depending on its materials. Please check and evaluate these materials carefully before use.

- 10) In case of acrylic plate is attached to front side of LCD panel, cloudiness (very small cracks) can occur on acrylic plate, being influenced by some components generated from polarizer film. Please check and evaluate those acrylic materials carefully before use.
- 11) Flickering due to optical interference may occur by combination of a) LCD driving frame frequency decided by either internal oscillator in driver IC or external clock input by the customer and b) lighting frequency of either backlight or other light sources. Please evaluate enough at the environment of actual use, and decide the driving condition that does not cause flickering.
- 12) Please be advised that do not apply DC voltage to the LCD.
If DC voltage is applied to the LCD, then it may cause poor display quality.

15. Warranty

This product has been manufactured to your company's specifications as a part for use in your company's general electronic products. It is guaranteed to perform according to delivery specifications. For any other use apart from general electronic equipment, we cannot take responsibility if the product is used in medical devices, nuclear power control equipment, aerospace equipment, fire and security systems, or any other applications in which there is a direct risk to human life and where extremely high levels of reliability are required. If the product is to be used in any of the above applications, we will need to enter into a separate product liability agreement.

- 1) We cannot accept responsibility for any defect, which may arise from additional manufacturing of the product (including disassembly and reassembly), after product delivery.
- 2) We cannot accept responsibility for any defect, which may arise after the application of strong external force to the product.
- 3) We cannot accept responsibility for any defect, which may arise due to the application of static electricity after the product has passed your company's acceptance inspection procedures.
- 4) We cannot accept responsibility for intellectual property of a third party, which may arise through the application of our product to your assembly with exception to those issues relating directly to the structure or method of manufacturing of our product.
- 5) Optrex will not be held responsible for any quality issue(s) after two years and beyond from its production date indicated on the lot number (please refer to "Code System of Production Lot" indicated earlier in this specification).