



LCD Module Technical Specification

First Edition
Oct 17, 2001
Final Revision

T-51381L064J-FW-P-AC

液晶之友 电话: 020-33819057
[Http://www.lcdfriends.com](http://www.lcdfriends.com)

Checked by (Quality Assurance Div.)

Checked by (Design Engineering Div.)

Prepared by (Production Div.)

Table of Contents

1. Application	2
2. Features	2
3. Mechanical Specifications	2
4. Mechanical Drawing of module	3
5. Input/output Terminals	4
6. Absolute Maximum Ratings	5
7. Electrical Characteristics	5
8. Optical Characteristics	11
9. Handling Cautions	14
10. Reliability Test	15
11. Block Diagram	16
12. Appendix	17

Revision History

Rev.	Date	Page	Comment

1. Application

This technical specification applies to 6.4" color TFT-LCD module, T-51381L064J-FW-P-AC.

2. Features

- . Compatible with PAL system
- . Pixel in stripe configuration
- . Slim and compact
- . Active area / Outline area = 67.9 %
- . Optimum Viewing Direction : 6 o'clock

3. Mechanical Specifications

Parameter	Specifications	Unit
Screen Size	6.4 (diagonal)	inch
Display Format	960×234	dot
Active Area	130.6 (H)×97.3 (V)	mm
Dot Pitch	0.136 (H)×0.416 (V)	mm
Pixel Configuration	Stripe	
Outline Dimension	156.3 (W)×119.8 (H)×14.3 (D)	mm
Weight	280±5	g

4. Mechanical Drawing of TFT-LCD Module

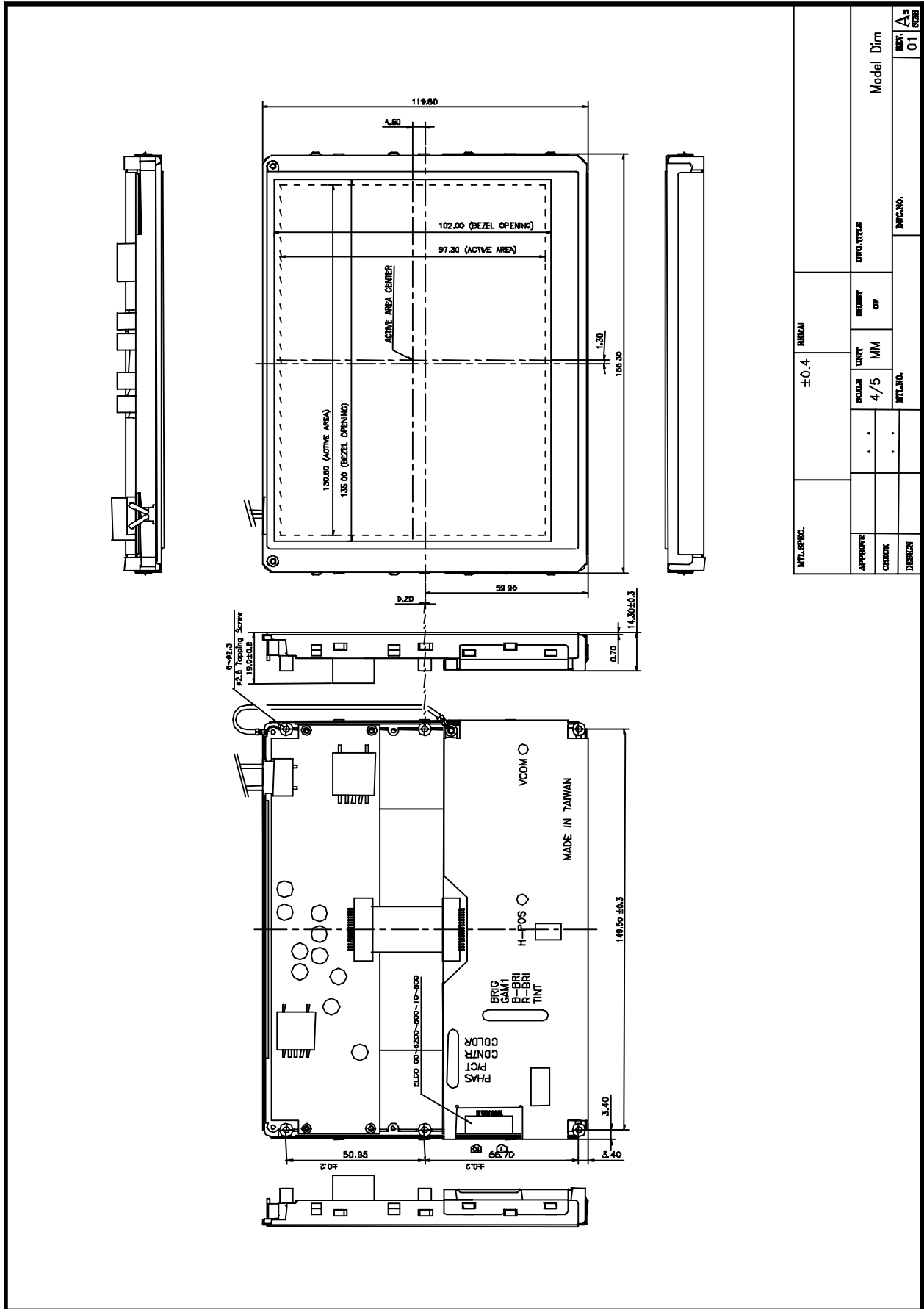

MPL.DWG.C.		REVISION		MPL.DWG.C.		Model Dirm	
±0.4		SCALE	UNIT	REQUIRE	DWG. NO.		REV. NO.
		4/5	MM	OP			01
APPROVE							A
CHECK							01
DESIGNER							01

5. Input / Output Terminals

5-1) TFT-LCD Panel Driving

10 PIN				
Pin No	Symbol	I/O	Description	Remark
1	+5V	O	5V output	
2	COL	I	COLOR	Note 5-1
3	BRT	I	BRIGHTNESS	Note 5-1
4	CNT	I	CONTRAST	Note 5-1
5	VIDEO	I	COMPOSITE VIDEO SIGNAL	
6	GNDS	I	VIDEO GROUND	
7	GNDP	I	12V POWER GROUND	
8	GNDP	I	12V POWER GROUND	
9	+12V	I	+12V DC POWER INPUT	
10	+12V	I	+12V DC POWER INPUT	

Note 5-1 : You can use pin1 (+5V) and variable resistor (VR) to adjust color, brightness and contrast.

5-2) Backlight driving

Pin No	Symbol	Description	Remark
1	VL1	Input terminal (Hi voltage side)	
2	VL2	Input terminal (Low voltage side)	Note 5-2

Note 5-2 : Low voltage side of backlight inverter connects with Ground of inverter circuits.

5-3) Input / Output Connector

A) Video & Power Input Connector

ELCO 00-6200-500-10-800

Pin No. : 10

Pitch : 1.0 mm

B) LCD Module Connector

ELCO 00-6200-500-16-800

Pin No. : 16

Pitch : 1.0mm

C) Backlight Connector

Jst BHR-03VS-1

Pin No. : 3

Pitch : 4mm

6. Absolute Maximum Ratings:

GND = 0 V , Ta = 25 C

Parameter	Symbol	MIN.	MAX.	Unit	Remark
Supply Voltage for Source Driver	V_{SH}	-0.5	+16	V	
Supply Voltage for Gate Driver	H Level	V_{GH}	+26.5	V	
	L Level	V_{GL}	20	V	
Supply voltage for controller	V_{DD}	-0.3	+6.5	V	
Digital input signals		-0.5	5.5	V	
Digital output signals		-0.5	5.5	V	
Storage Temperature		-30	+80	C	
Operation Temperature		-10	+60	C	

7. Electrical Characteristics

7-1) Recommended Operating Conditions:

A) Driving for TFT-LCD Panel

GND = 0V , Ta = 25 C

Parameter	Symbol	MIN.	TYP	MAX.	Unit	Remark	
Supply voltage for source driver	V_{SH}	+13.5	+14	+14.5	V		
Supply voltage for gate driver	H Level	V_{GH}	+19	+20	+24	V	
	L level	V_{GL}	-5.5	-5	-4	V	
Supply voltage for controller	V_{DD}	+4.7	+5	+5.3	V		
Digital input Voltage	H level		+2.4	-	+5	V	Note 7-1
	L level		-0.3	-	+0.8	V	
Digital output voltage	H level		+5	+5.5	V	Note 7-2	
	L level		0	-	+0.45		V

Note 7-1 : \overline{HSY} , \overline{CSY} , \overline{VSY} , \overline{CKC}

Note 7-2 : \overline{HSY} , \overline{VSY} , \overline{PSI} , \overline{PSC} , \overline{FRP}

B) Power on sequence (Voltage source)

The power on sequence only effect by V_{DD} , V_{GL} and V_{GH} , the others do not care.

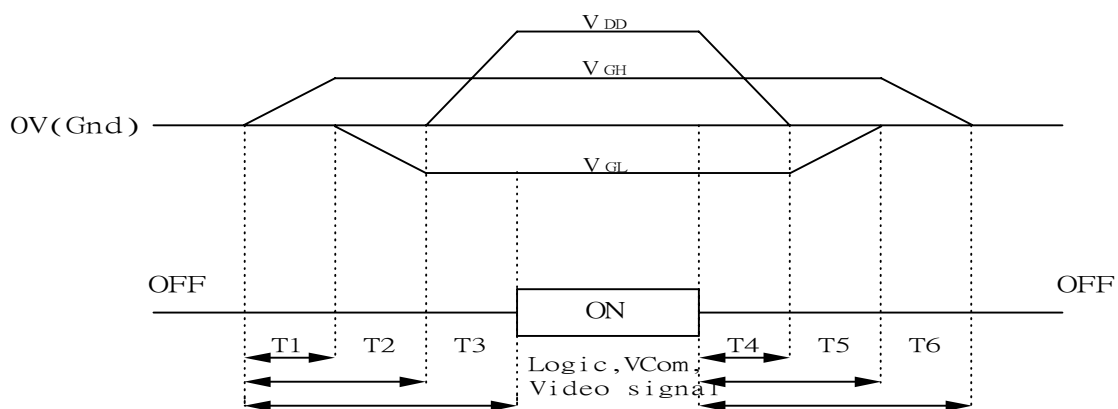

1) 10ms T1 T2 T3

2) 10ms T4 T5 T6

C) Driving for backlight

Ta= 25 C

Parameter	Symbol	Min.	Typ.	Max.	Unit	Remark
Lamp voltage	V _L	470	520	630	Vrms	I _L =6mA
Lamp current	I _L	4	6	8	mA	
Lamp frequency	P _L	20	35	60	KHz	Note 7-3
Kick-off voltage	V _s			1500	Vrms	

Note 7-3 : The wave form of lamp driving voltage should be as closed to a perfect SIN wave as possible.

7-2) Power Consumption

Ta= 25 C

Parameter	Symbol	Conditions	TYP.	MAX	Unit	Remark
Supply current for Gate Driver(Hi Level)	I _{GH}	V _{GH} =+20V	6	8	mA	
Supply current for Gate Driver(Low Level)	I _{GL}	V _{GL} =-5V	5	8	mA	
Supply current for Source Driver	I _{SH}	V _{EE} =+14V	9	15	mA	
Supply current for Controller	I _{DD}	V _{DD} =+5V	50	100	mA	
Supply current	I _{CC}	V _{CC} =+13V	3	15	mA	
Total Power Consumption			0.56		W	Note 7-4
Backlight Lamp Power Consumption			3.12		W	Note 7-5

Note 7-4 : The power consumption for backlight is not included.

Note 7-5 : Backlight lamp power consumption is calculated by I_L X V_L

7-3) Input / Output signal timing chart

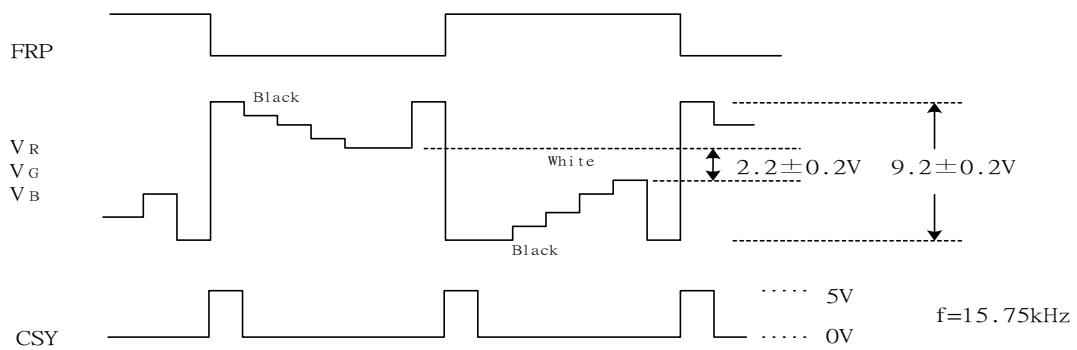

Parameter	Symbol	MIN.	TYP.	MAX.	Unit	Remarks
Horizontal Sync. Output	Width	T _{HO}	4.2	4.7	5.2	μs
	Phase Difference	T _{HP}	0	2		μs
Pulse	Rising Time	T _{HR}	-	-	0.5	μs
	Falling Time	T _{HF}	-	-	0.5	μs
Vertical Sync. Output Pulse	Width	T _{VO}	-	4H	-	μs H=1/15.75KHZ
	Phase Difference	T _{VPO}	-	1H	-	μs odd field
	Phase Difference	T _{VPE}	-	0.5H	-	μs even field
	Rising Time	T _{VR}	-	-	2	μs
	Frequency	f _{FRP}	7.67	7.87	8.07	KHz
Polarity Alternating Signal	Delay time	T _{FD}	-	-	4	μs
	Falling Time	T _{VF}	-	-	2	μs

7-4) Display Time Range

A) When sync. signal of PAL system is applied.

- a) Horizontally
13.0 ~ 63.8 μ s.
- b) Vertical
26 ~ 298 H
- c) odd field : Scan lines $14n+17$ $14n+23(n=1,2,3\dots)$ are not displayed.
even field : Scan lines $14n+12$ $14n+20(n=1,2,3\dots)$ are not displayed.

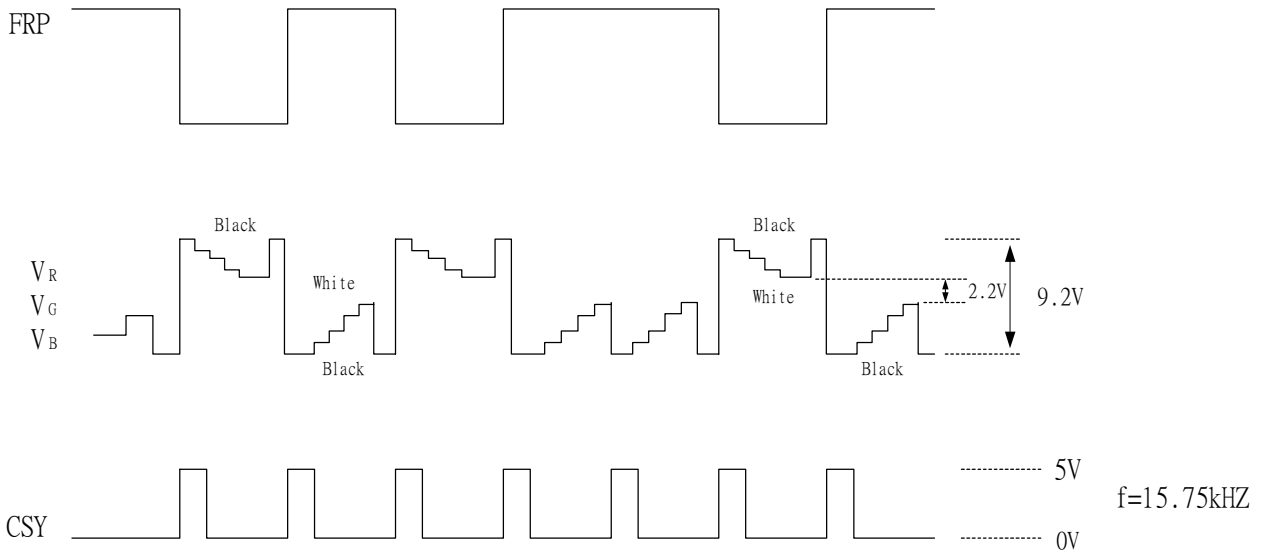

B) PAL System

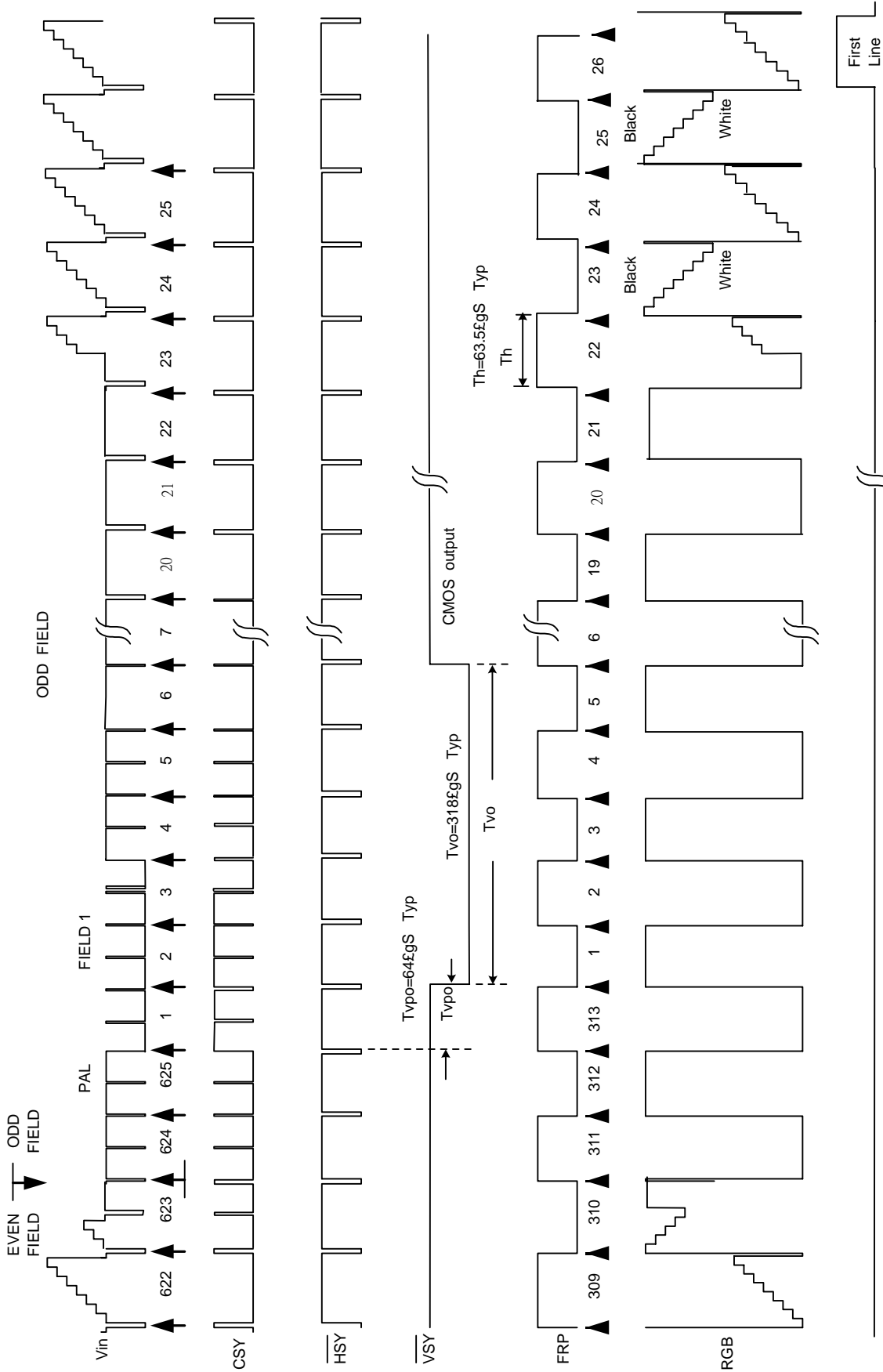

Timing chart of I/O and RGB signal

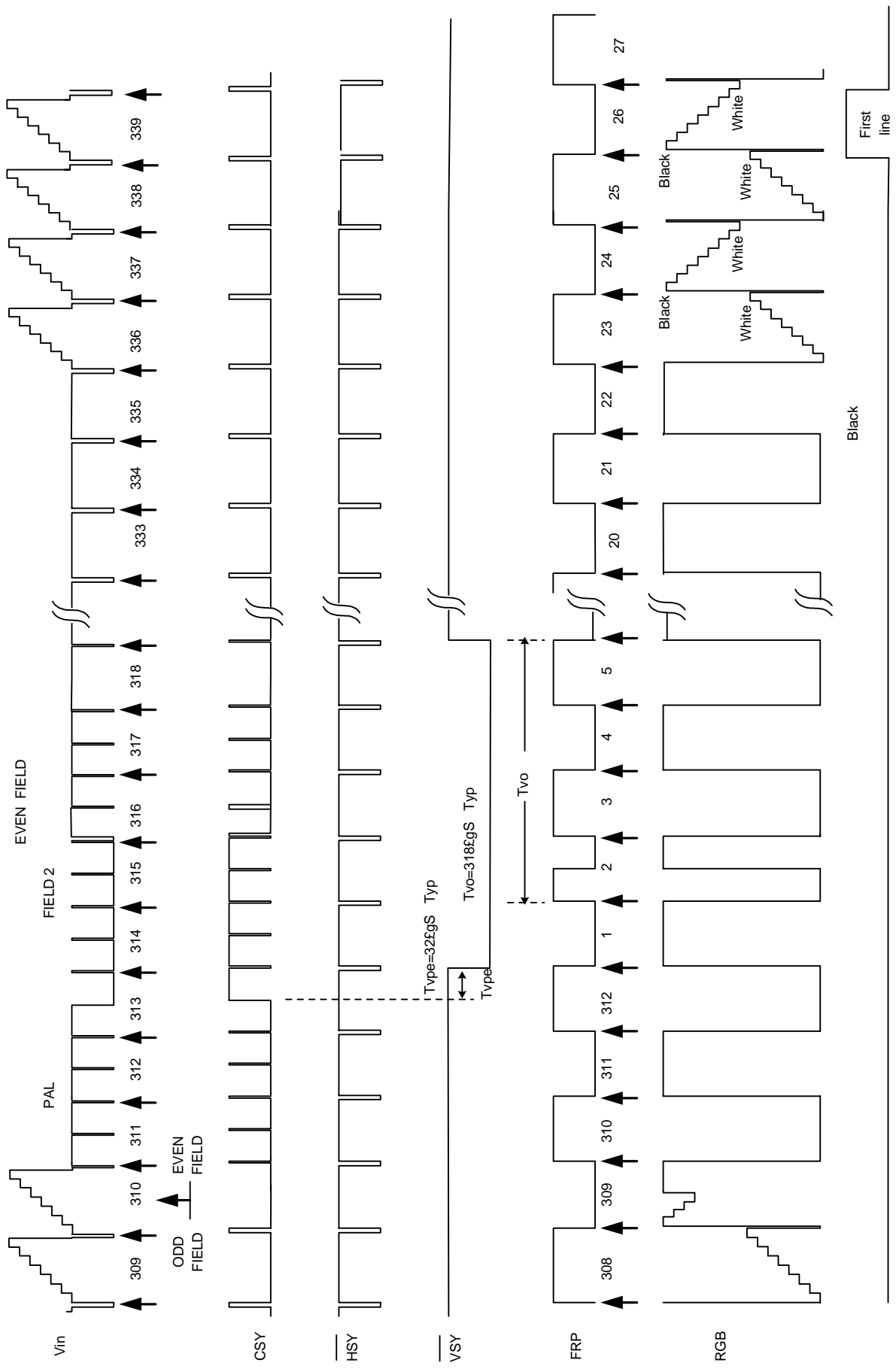

Timing chart of I/O and RGB signal

PAL Display Timing

Sampling Clock: 18.9MHz

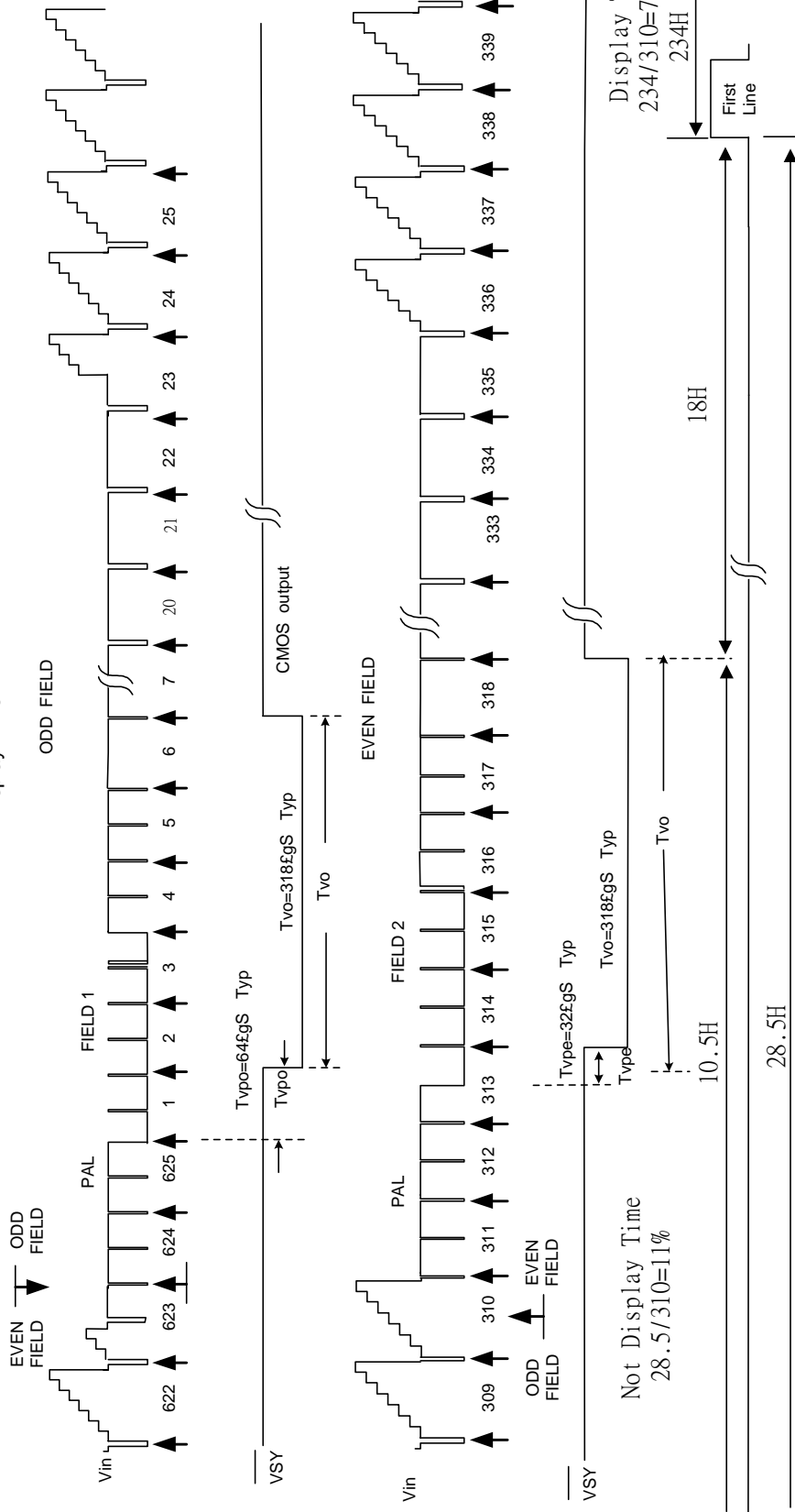
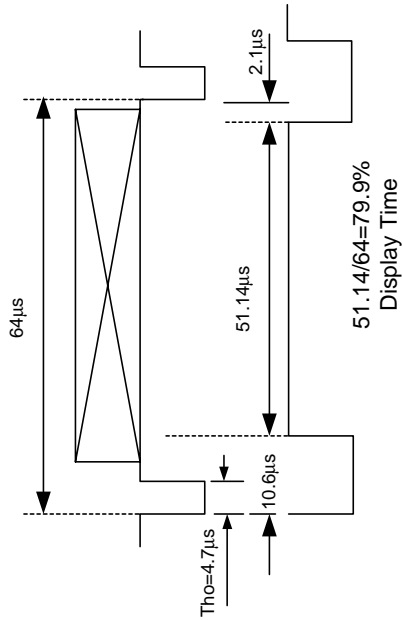

8. Optical Characteristics

8-1) Specification:

Ta = 25°C

Parameter		Symbol	Condition	MIN.	TYP.	MAX.	Unit	Remarks
Viewing Angle	Horizontal	θ	CR \geq 10	± 45	± 55		deg	Note 8-1
	Vertical	θ (to 12 o'clock)		10	15		deg	
		θ (to 6 o'clock)		30	35		deg	
Contrast Ratio		CR		80	120			Note 8-2
Response time	Rise	Tr	$\theta = 0^\circ$			30	ms	Note 8-4
	Fall	Tf	$\Phi = 0^\circ$			50	ms	
Brightness				250	300		cd/m ²	Note 8-3
White Chromaticity		x		0.255	0.305	0.355		
		y		0.300	0.350	0.400		
Lamp Life Time	+25°C			10,000			hr	

Note 8-1: The definitions of viewing angles

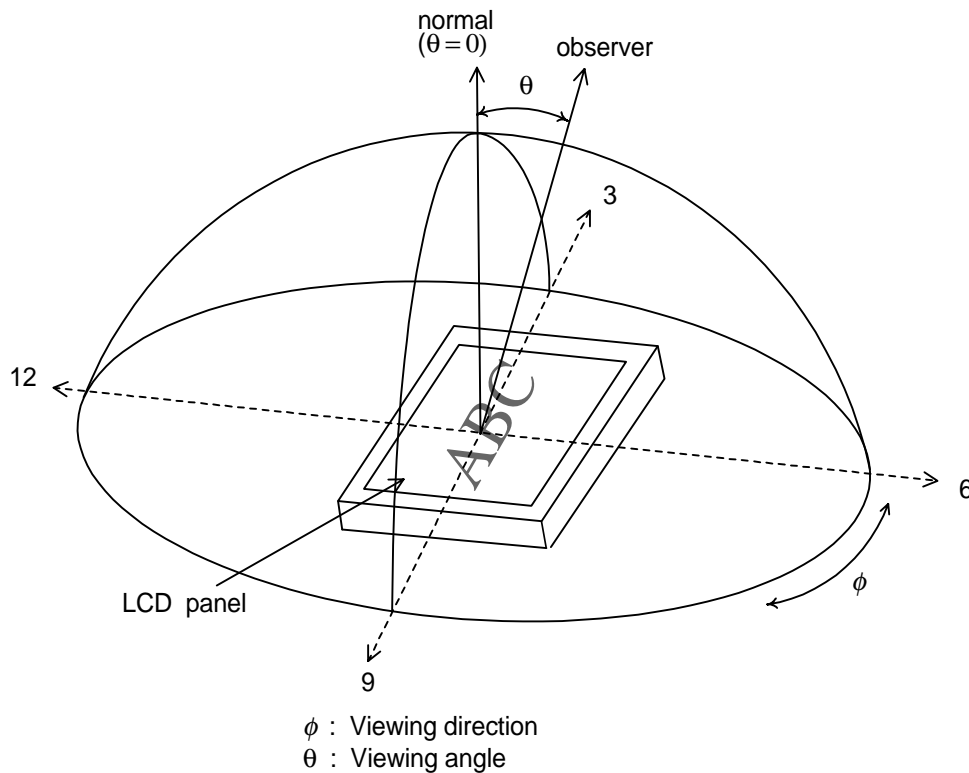

Note 8-2 : CR = $\frac{\text{Luminance when Testing point is White}}{\text{Luminance when Testing point is Black}}$

(Testing configuration see 8-2)

Contrast Ratio is measured in optimum common electrode voltage.

Note 8-3 : Topcon BM-7(fast) luminance meter 2° field of view is used in the testing (after 20~30 minutes operation).

Lamp Current is 6mA.

Note 8-4 : The definition of response time:

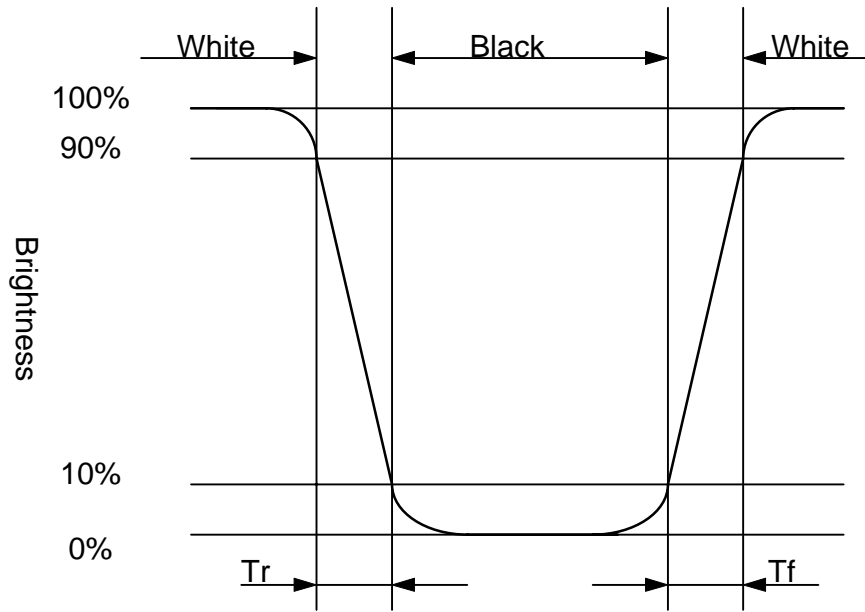

8-2) Testing configuration

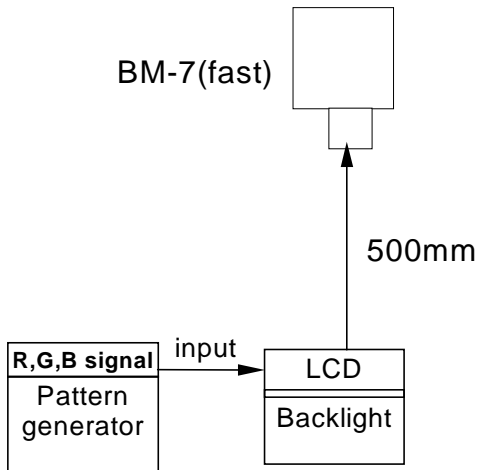

Caution: 1. Environmental illumination 1 lux
 2. Before test CR, Vcom voltage must be adjusted carefully to get the best CR.

- LCD Display

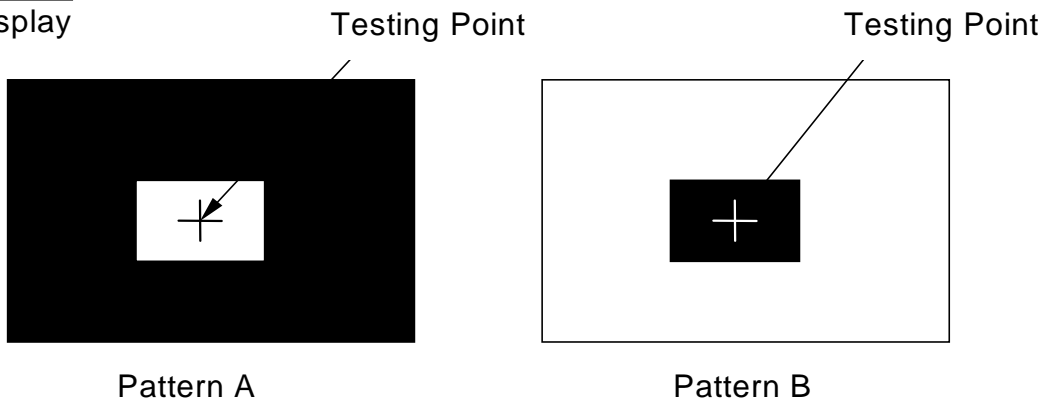

- R, G, B Waveform of Pattern A at Testing Point

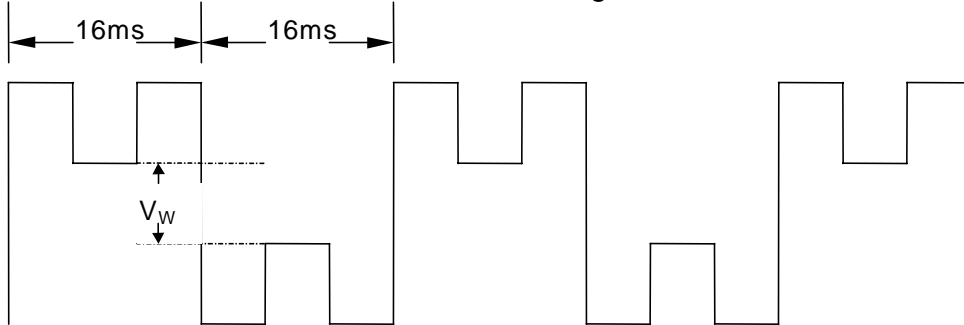

$$V_w = 2.2V \pm 0.2V$$

- G, B Waveform of Pattern B at Testing Point

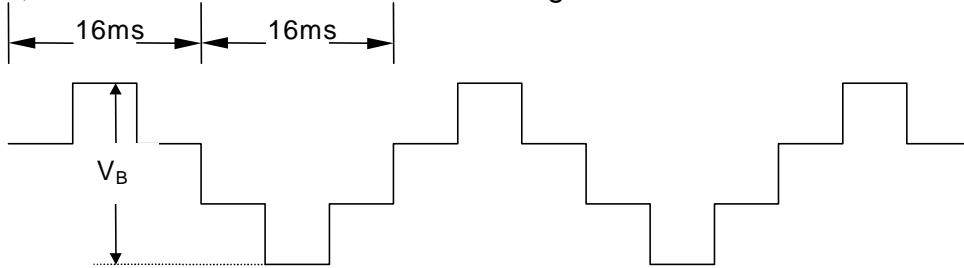

$$V_b = 9.2V \pm 0.2V$$

9. Handling Cautions

9-1) Mounting of module

- a) Please power off the module when you connect the input/output connector.
- b) Please connect the ground pattern of the inverter circuit surely. If the connection is not perfect, some following problems may happen possibly.
 - 1. The noise from the backlight unit will increase.
 - 2. The output from inverter circuit will be unstable.
 - 3. In some cases a part of module will heat.
- c) Polarizer which is made of soft material and susceptible to flaw must be handled carefully.
- d) Protective film (Laminator) is applied on surface to protect it against scratches and dirt. It is recommended to peel off the laminator before use and taking care of static electricity.

9-2) Precautions in mounting

- a) When metal part of the TFT-LCD module (shielding lid and rear case) is soiled, wipe it with soft dry cloth.
- b) Wipe off water drops or finger grease immediately. Long contact with water may cause discoloration or spots.
- c) TFT-LCD module uses glass which breaks or cracks easily if dropped or bumped on hard surface. Please handle with care.
- d) Since CMOS LSI is used in the module. So take care of static electricity and earth yourself when handling.

9-3) Adjusting module

- a) Adjusting volumes on the rear face of the module have been set optimally before shipment.
- b) Therefore, do not change any adjusted values. If adjusted values are changed, the specifications described may not be satisfied.

9-4) Others

- a) Do not expose the module to direct sunlight or intensive ultraviolet rays for many hours.
- b) Store the module at a room temperature place.
- c) The voltage of beginning electric discharge may over the normal voltage because of leakage current from approach conductor by to draw lump read lead line around.
- d) If LCD panel breaks, it is possibly that the liquid crystal escapes from the panel. Avoid putting it into eyes or mouth. When liquid crystal sticks on hands, clothes or feet. Wash it out immediately with soap.
- e) Observe all other precautionary requirements in handling general electronic components.
- f) Please adjust the voltage of common electrode as material of attachment by 1 module.

10. Reliability Test

No	Test Item	Test Condition
1	High Temperature Storage Test	Ta = +80 C, 240 hrs
2	Low Temperature Storage Test	Ta = -30C, 240 hrs
3	High Temperature Operation Test	Ta = +60 C, 240 hrs
4	Low Temperature Operation Test	Ta = -10 C, 240 hrs
5	High Temperature & High Humidity Operation Test	Ta = +60C, 95%RH, 240 hrs
6	Thermal Cycling Test (non-operating)	-25C +25C +70C, 200 Cycles 30 min 5min 30 min
7	Vibration Test (non-operating)	Frequency : 10 ~ 55 Hz Amplitude : 1.5 mm Sweep time : 11 mins Test period : 2 hrs for each direction of X, Y, Z
8	Shock Test (non-operating)	100G, 6ms Direction : ± X, ± Y, ± Z Cycle : 3 times
9	Electrostatic Discharge Test	150pF, 330 Air : ± 15KV; Contact : ± 8KV 10 times/point, 9 points/panel face

Ta: ambient temperature

[Criteria]

Under the display quality test conditions with normal operation state, there should be no change which may affect practical display function.

11. Indication of Lot Number Label

a) Indicated contents of the label

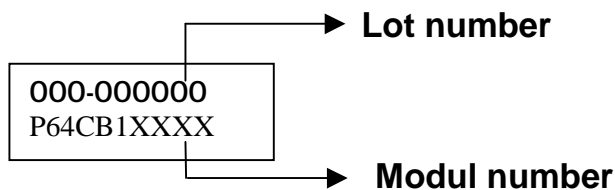

Contents of lot number : 1st—Process area : class 1000 ⇒ H
class 100K ⇒ M

2nd~3rd—Module screen size(in inch) : 1.8"⇒18, 2.5"⇒25.....

5th—Production year : 1999⇒9, 2000⇒A, 2001⇒1.....

6th—Production month : 1, 2, 3,....9, A, B, C

7th~10th—Serial numbers : 0001~9999

12. Block Diagram

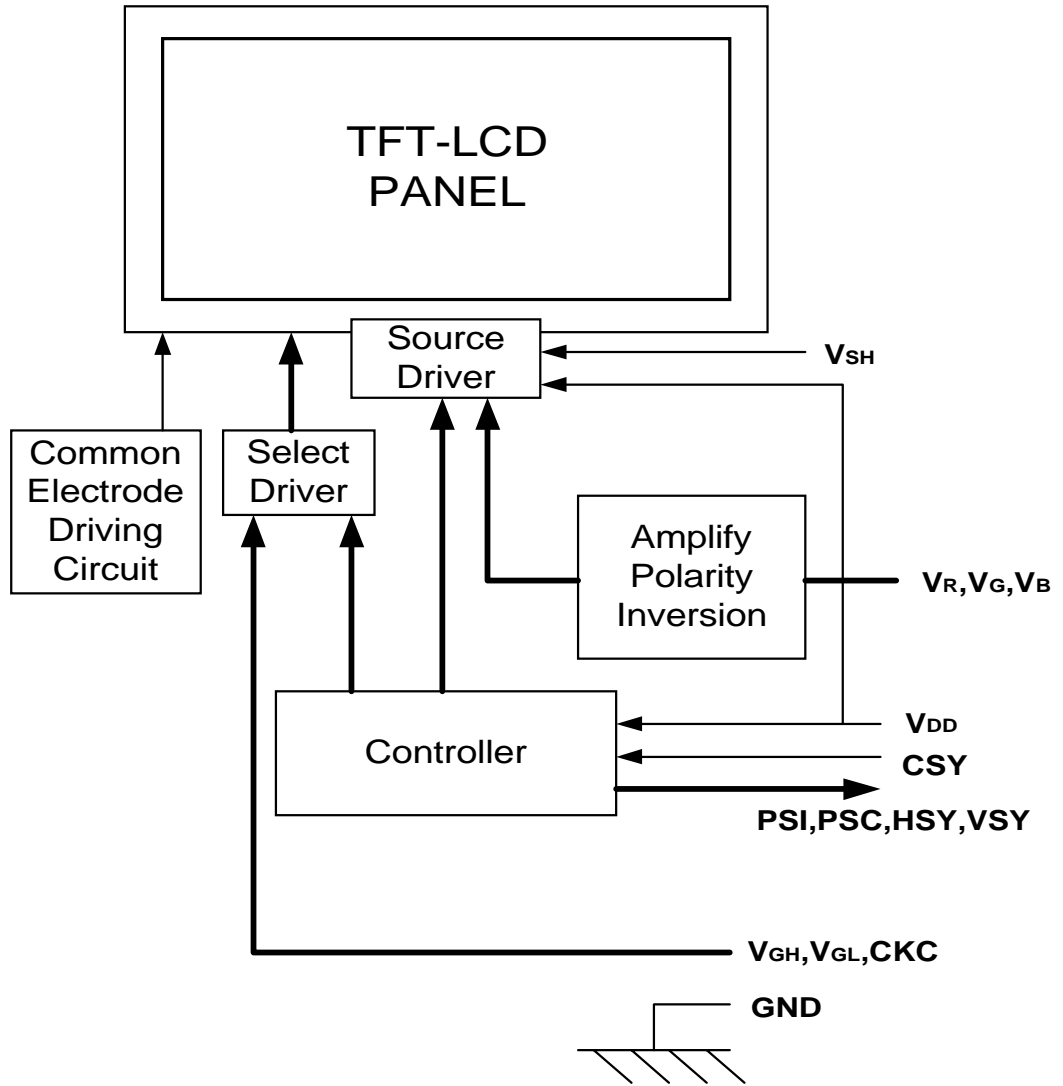

Appendix

DC-DC CONVERTER / DC-AC INVERTER
6.4" SWITCHING POWER SUPPLY BOARD
MODEL NO. : 71-9010021

1. Application

This technical specification applies to DC – DC Converter / DC – AC Backlight Inverter Board, 71-9010021.

2. Features

- . Brightness Adjustable
- . Apply to 6.4" TFT-LCD MODULE

3. Mechanical Specifications

Parameter	Specifications	Unit
Outline Dimension	152.6 (H) × 40.3 (V) × 10.0 (D)	mm
Weight	38	g

4. Mechanical Drawing

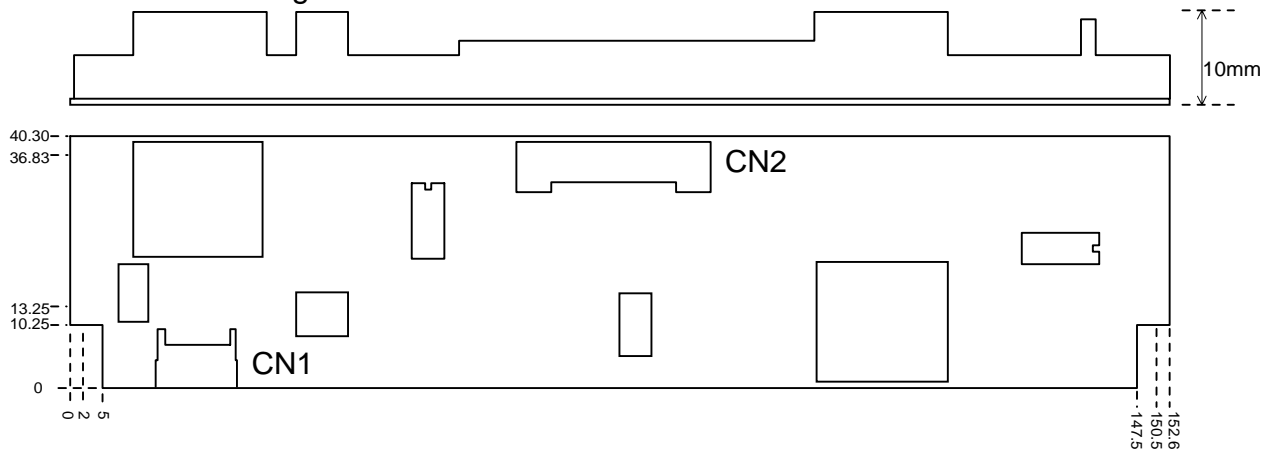

CN1 : TYPE : JST SM02(8.0)B-BHS-1-TB

CN2 : TYPE : ELCO 6200-500-16-800 BOTTOM CONTACT

PIN ASSIGNMENT : (1) 20V O/P

(2) GND

(3) -5V O/P

(4) PSI I/P(INVERTER SYNC.) NC

(5) PSC I/P(CONVERTER SYNC.)

(6) 5V O/P

(7) GND

(8) 14V O/P

(9) GND

(10) 13V O/P

(11) ENABLE

(12) ADJ

(13) GND I/P

(14) GND I/P

(15) +12V I/P

(16) +12V I/P

5. Input / Output Terminals

5-1) Connect To Backlight (CN1)

Pin No.	Symbol	I/O	Description	Remark
1	VL1	O	High Voltage for Lamp	
2	VL2	O	Low Voltage for Lamp (Ground)	

5-2) Connect to Chroma Decoder (CN2)

Pin No	Symbol	I/O	Description	Remark
1	V _{GH}	O	Supply Voltage for LCD Gate Driver (Hi level)	Note 1
2	GND		Ground	
3	V _{GL}	O	Supply Voltage for LCD Gate Driver (Low level)	Note 2
4	PSI	I	Synchronize Pulse for Backlight Inverter	Note 8
5	PSC	I	Synchronize Pulse for DC-DC Converter	Note 8
6	V _{DD}	O	Supply voltage for Controller / Decoder	Note 3
7	GND		Ground	
8	V _{SH}	O	Supply voltage for LCD source driver	Note 4
9	GND		Ground	
10	V _{EE}	O	Supply Voltage for Video Decoder	Note 5
11	ENA	I	Power save option	Note 7
12	DIM	I	Adjust the brightness of backlight	Note 6
13	GND	I	Ground	
14	GND	I	Ground	
15	V _P	I	Input Voltage for DC-DC converter / Backlight Inverter	Note 9
16	V _P	I	Input Voltage for DC-DC converter / Backlight Inverter	

Note 1 : V_{GH} : +20V (Typ.).

Note 2 : V_{GL} : -5V (Typ.).

Note 3 : V_{DD} : +5V (Typ.).

Note 4 : V_{SH} : +14V (Typ.).

Note 5 : V_{EE} : +13V (Typ.).

Note 6 : Pin 12 (DIM) can adjust the brightness of backlight by changing the input voltage between

+0.6V to +2V. If the input voltage is +0.6V the brightness is the lowest. The brightness will increase when the input signal increase.

Pin 12 (DIM)	Brightness
Hi (+2.0V)	Highest
Low (+0.6V)	Lowest
Open	Highest

Note 7 : When Pin 11 (ENA) is driven high, the system is enabled. when Pin 5 (ENA) is pulled low, the system is shut down.

Pin 11 (ENA)	LCD System
Hi (+2V~+5V)	Enable
Low (<+0.3V)	System turn off
Open	Normal Operation

Note 8 : Please refer to the specification of LCD module.

Note 9 : V_P : +12V (Typ.)

6. Connector

Connector No.	CN 1	CN 2
Type	Shrouded Header	FFC Down Connector
Pins	2	16
Pitch	8 mm	1 mm
Maker	JST	ELCO
Model No.	SM02(8.0)B-BHS-1-TB	6200-500-16-800

7. Electrical Characteristics

7-1) Recommended Operating Conditions:

GND = 0V , $T_a = 25\text{ C}$

Parameter	Symbol	MIN.	TYP	MAX.	Unit	Remark
Supply Voltage for DC-DC Converter	V_P	+10.8	+12	+14	V	
Supply voltage for source driver	V_{SH}	+13.5	+14	+14.5	V	
Supply voltage for gate driver	H Level	V_{GH}	+18.8	+20	+21.2	V
	L level	V_{GL}	-5.5	-5	-4.5	V
Supply voltage for controller/ Decoder	V_{DD}	+4.75	+5	+5.25	V	
Supply voltage for decoder	V_{EE}	+12	+13	+14	V	
Lamp Voltage	VL1		550	1400	Vrms	
Lamp Current	IL1	7.2	8	8.8	mA	

7-2) Power Consumption

Parameter	Symbol	Conditions	TYP.	MAX	Unit	Remark
Supply Current for DC-DC Converter	V_C	$V_C = +12V$	190		mA	2.3W
Supply Current for Backlight Inverter	V_I	$V_I = +12V$	366		mA	4.4W
Total Power Consumption				9.6	W	Note A

Note A : DC input current : 0.8 A \pm 10% typical at 12Vdc input.

8. Environment Operating Characteristics

- .Temperature : -10C ~ +70C.
- .Temperature coefficient : \pm 0.03% / C over the entire operating temperature.
- .Relative humidity : 5 ~ 95% RH. ,non-condensation.
- .Altitude : 0 ~ 7000 feet.
- .Cooling : Free air convection cooling.

9. Storage Characteristics

- .Temperature : -30 ~ +85C
- . Relative humidity : 0 ~ 95% RH. ,non-condensation.
- . Vibration : 1.5mm , 10 ~ 50 Hz. Gravity=1G , Sweep Time=15 minutes ,
Test period=2 hours , for each axis (X,Y,Z).

10. Reliability : 10000 hours MIN. at MAX. load and 25C ambient.

11. ESD Test

The power supply is designed to correspondance with the IEC801-2 ESD rule criterion B.

Test condition : (1). Contact discharge 8kV.

(2). Directly discharge accessible metal part at least 10 times.

(3). Impairment of function outside the device's error limits ,but with automatic recovery after exposure.

Test result : Perfectly meet the test condition.

12.Assembly Drawing

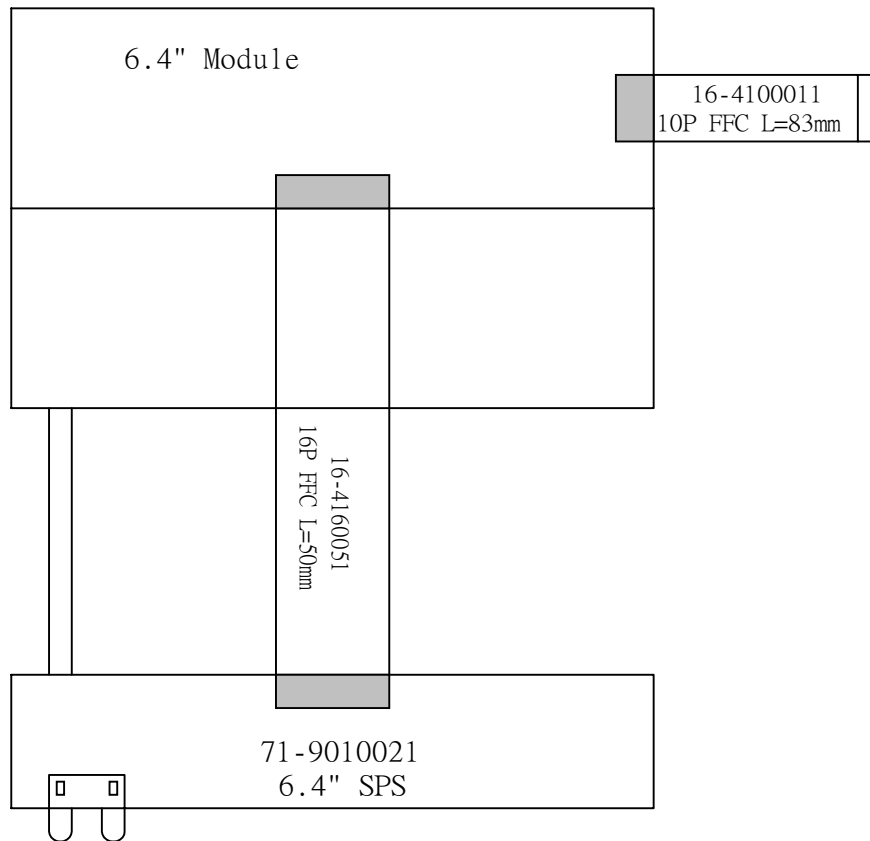

WARNING !

Before power on , please make sure the 16-pin cable to be connected properly. Improper connection of the 16-pin cable to the socket may permanently damage the module.

Instruction:

1. Connect DC 12V to "Power Supply Board". DO NOT TURN ON.
2. Connect Video AV to "Decoder Board". DO NOT TURN ON.
3. Power on DC 12V.