

Insulated Gate Bi-Polar Transistor

Type T0340VB45G

Absolute Maximum Ratings

	VOLTAGE RATINGS	MAXIMUM LIMITS	UNITS
V_{CES}	Collector – emitter voltage	4500	V
$V_{DC\ link}$	Permanent DC voltage for 100 FIT failure rate.	2800	V
V_{GES}	Peak gate – emitter voltage	± 20	V

	RATINGS	MAXIMUM LIMITS	UNITS
$I_{C(DC)}$	DC collector current, IGBT	340	A
I_{CRM}	Repetitive peak collector current, $t_p=1ms$, IGBT	680	A
$I_{F(DC)}$	Continuous DC forward current, Diode	340	A
I_{FRM}	Repetitive peak forward current, $t_p=1ms$, Diode	680	A
I_{FSM}	Peak non-repetitive surge $t_p=10ms$, $V_{RM}=60\%V_{RRM}$, Diode (Note 4)	2060	A
I_{FSM2}	Peak non-repetitive surge $t_p=10ms$, $V_{RM}\leq 10V$, Diode (Note 4)	2280	A
P_{MAX}	Maximum power dissipation, IGBT (Note 2)	2.7	kW
$(di/dt)_{cr}$	Critical diode di/dt (note 3)	500	A/ μs
T_j	Operating temperature range.	-40 to +125	$^{\circ}C$
T_{stg}	Storage temperature range.	-40 to +125	$^{\circ}C$

Notes: -

- 1) Unless otherwise indicated $T_j = 125^{\circ}C$.
- 2) $T_{sink} = 25^{\circ}C$, double side cooled.
- 3) Maximum commutation loop inductance 200nH.
- 4) Half-sinewave, $125^{\circ}C$ T_j initial.

Characteristics

IGBT Characteristics

	PARAMETER	MIN	TYP	MAX	TEST CONDITIONS	UNITS
V _{CE(sat)}	Collector – emitter saturation voltage	-	2.75	3.2	I _C = 340A, V _{GE} = 15V, T _j = 25°C	V
		-	3.50	3.9	I _C = 340A, V _{GE} = 15V	V
V _{T0}	Threshold voltage	-	-	2.18	Current range: 340 – 1020A	V
r _T	Slope resistance	-	-	5.05		mΩ
V _{GE(TH)}	Gate threshold voltage	-	5.2	-	V _{CE} = V _{GE} , I _C = 35mA	V
I _{CES}	Collector – emitter cut-off current	-	10	25	V _{CE} = V _{CES} , V _{GE} = 0V	mA
I _{GES}	Gate leakage current	-	-	±7	V _{GE} = ±20V	µA
C _{ies}	Input capacitance	-	60	-	V _{CE} = 25V, V _{GE} = 0V, f = 1MHz	nF
t _{d(on)}	Turn-on delay time	-	3.7	-	I _C = 340A, V _{CE} = 2800V, di/dt = 500A/µs	µs
t _{r(V)}	Rise time	-	3.2	-		µs
Q _{g(on)}	Turn-on gate charge	-	6.5	-	V _{GE} = ±15V, L _s = 200nH	µC
E _{on}	Turn-on energy	-	2.9	-	R _{g(ON)} = 18Ω, R _{g(OFF)} = 20Ω, C _{GE} = 47nF	J
t _{d(off)}	Turn-off delay time	-	2.2	-	Integral diode used as freewheel diode (Note 3 & 4)	µs
t _{r(I)}	Fall time	-	2.6	-		µs
Q _{g(off)}	Turn-off gate charge	-	10	-		µC
E _{off}	Turn-off energy	-	1.4	-		J
I _{SC}	Short circuit current	-	1100	-	V _{GE} = +15V, V _{CC} = 2800V, V _{CEmax} ≤ V _{CES} , t _p ≤ 10µs	A

Diode Characteristics

	PARAMETER	MIN	TYP	MAX	TEST CONDITIONS	UNITS
V _F	Forward voltage	-	3.3	3.6	I _F = 340A, T _j = 25°C	V
		-	3.45	3.8	I _F = 340A	V
V _{T0}	Threshold voltage	-	-	2.88	Current range 340-1020A	V
r _T	Slope resistance	-	-	2.72		mΩ
I _{rm}	Peak reverse recovery current	-	220	-	I _F = 340A, V _{GE} = -15V, di/dt = 500A/µs	A
Q _{rr}	Recovered charge	-	500	-		µC
t _{rr}	Reverse recovery time, 50% chord	-	3.2	-		µs
E _r	Reverse recovery energy	-	0.4	-		J

Thermal Characteristics

	PARAMETER	MIN	TYP	MAX	TEST CONDITIONS	UNITS
R _{thJK}	Thermal resistance junction to sink, IGBT	-	-	36.4	Double side cooled	K/kW
		-	-	94.3	Collector side cooled	K/kW
		-	-	59.4	Emitter side cooled	K/kW
R _{thJK}	Thermal resistance junction to sink, Diode	-	-	57.6	Double side cooled	K/kW
		-	-	88.2	Cathode side cooled	K/kW
		-	-	166	Anode side cooled	K/kW
F	Mounting force	12	-	16	Note 2	kN
W _t	Weight	-	0.65	-		kg

Notes:-

- 1) Unless otherwise indicated T_j = 125°C.
- 2) Consult application note 2008AN01 for detailed mounting requirements
- 3) C_{GE} is additional gate – emitter capacitance added to output of gate drive
- 4) Figures 6 to 9 are obtained using integral diode as freewheeling diode

Curves

Figure 1 – Typical collector-emitter saturation voltage characteristics

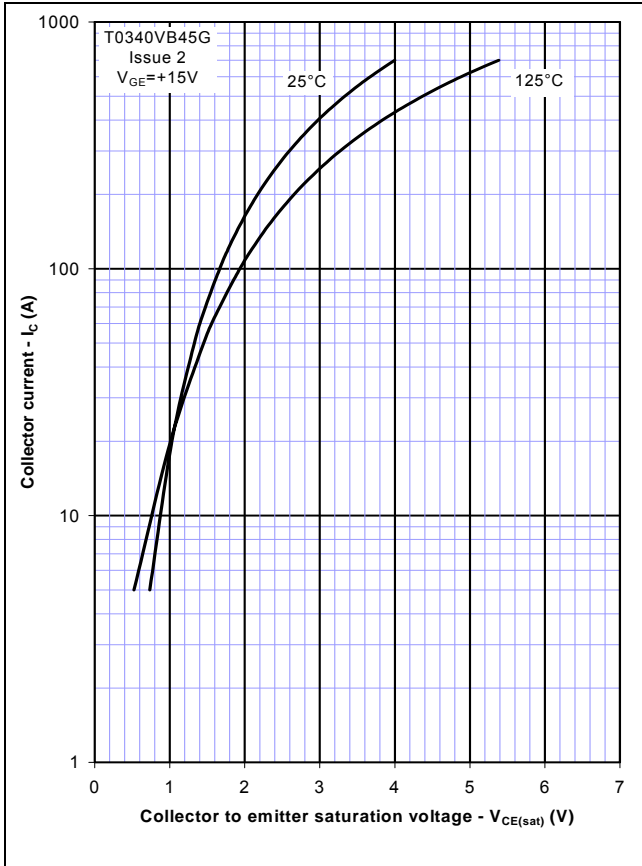

Figure 2 – Typical output characteristic

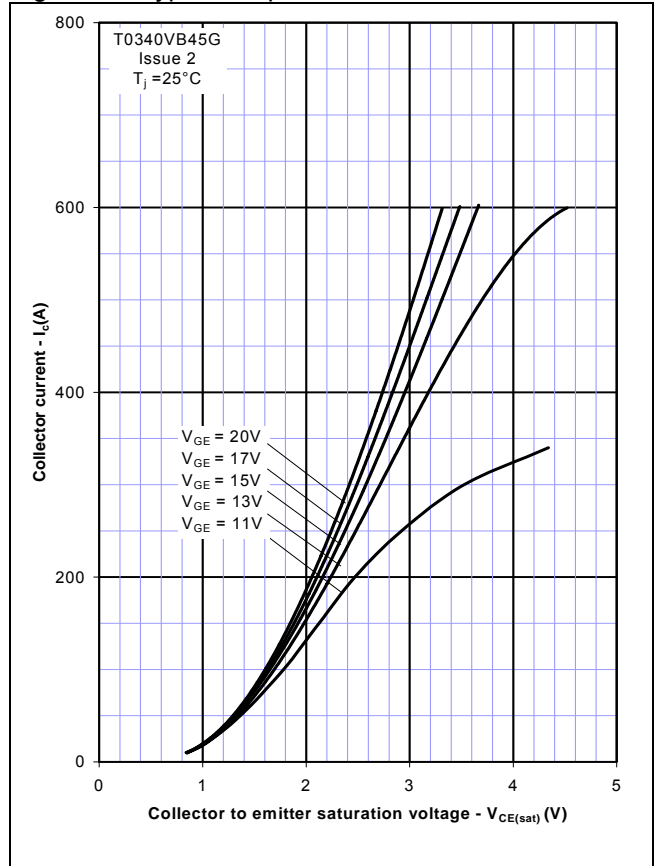

Figure 3 – Typical output characteristic

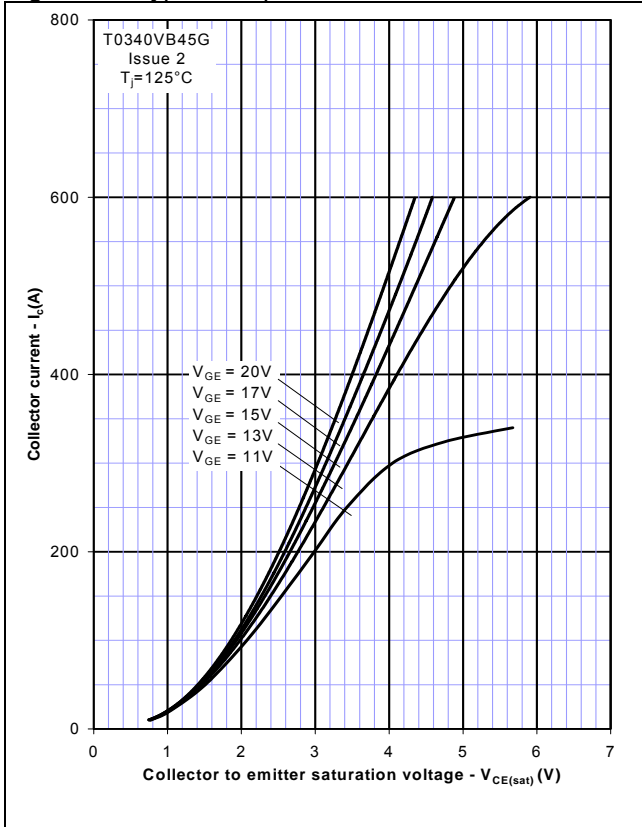

Figure 4 – Typical turn-on delay time vs gate resistance

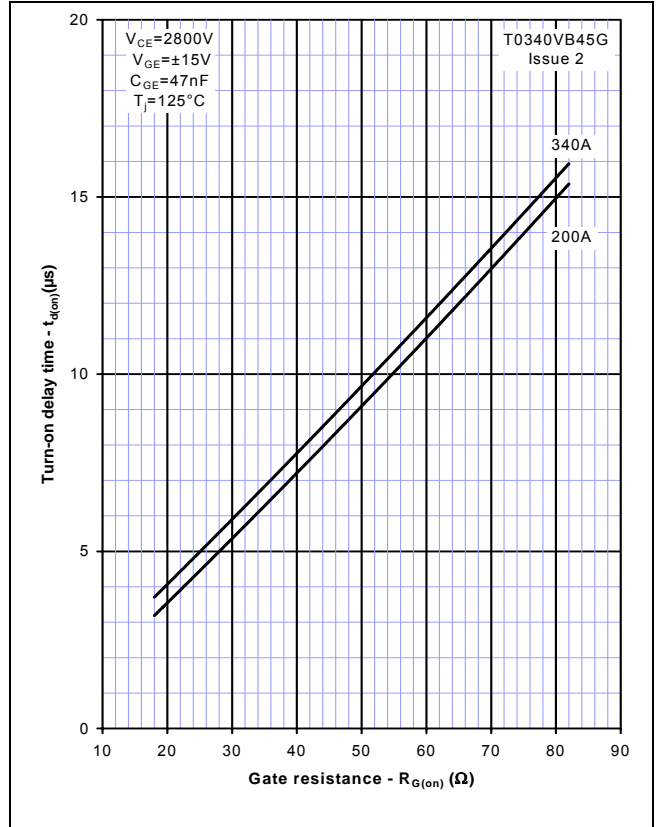

Figure 5 – Typical turn-off delay time vs. gate resistance

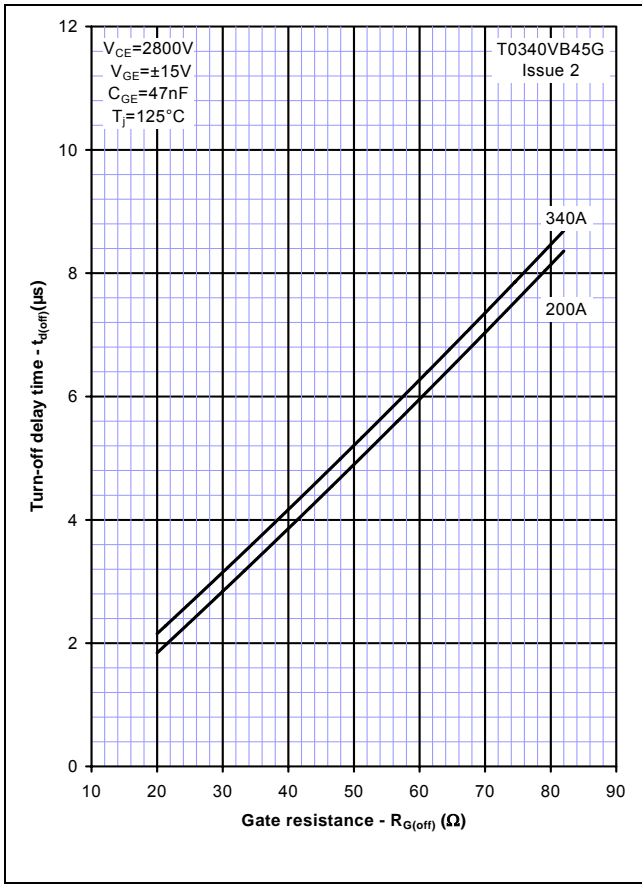

Figure 6 – Typical turn-on energy vs. collector current

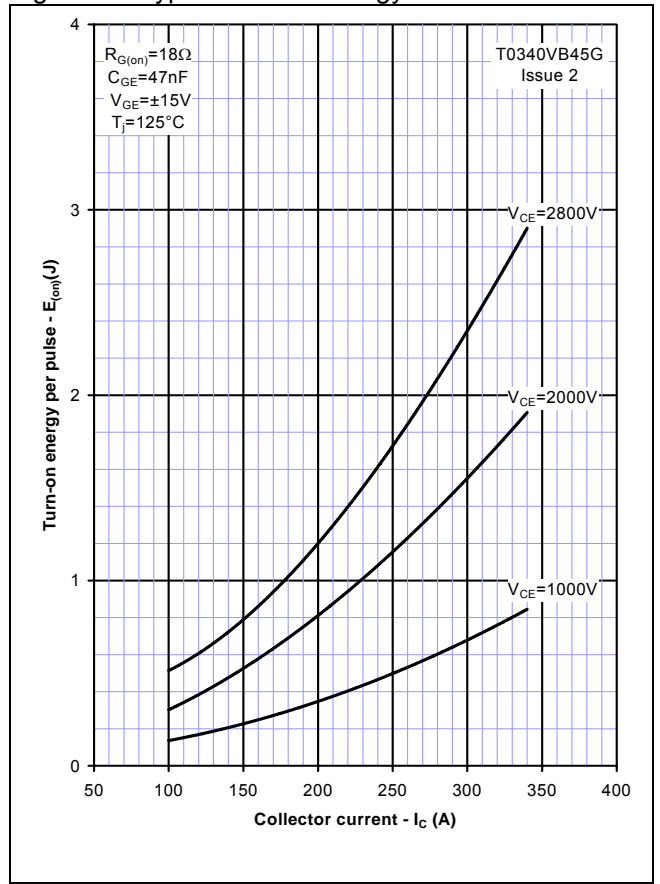

Figure 7 – Typical turn-on energy vs. di/dt

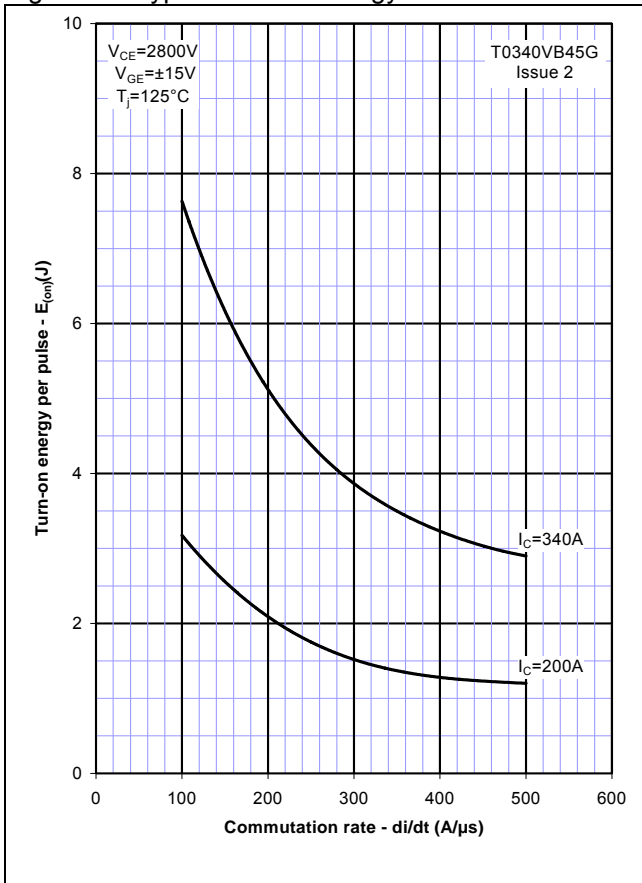

Figure 8 – Typical turn-off energy vs. collector current

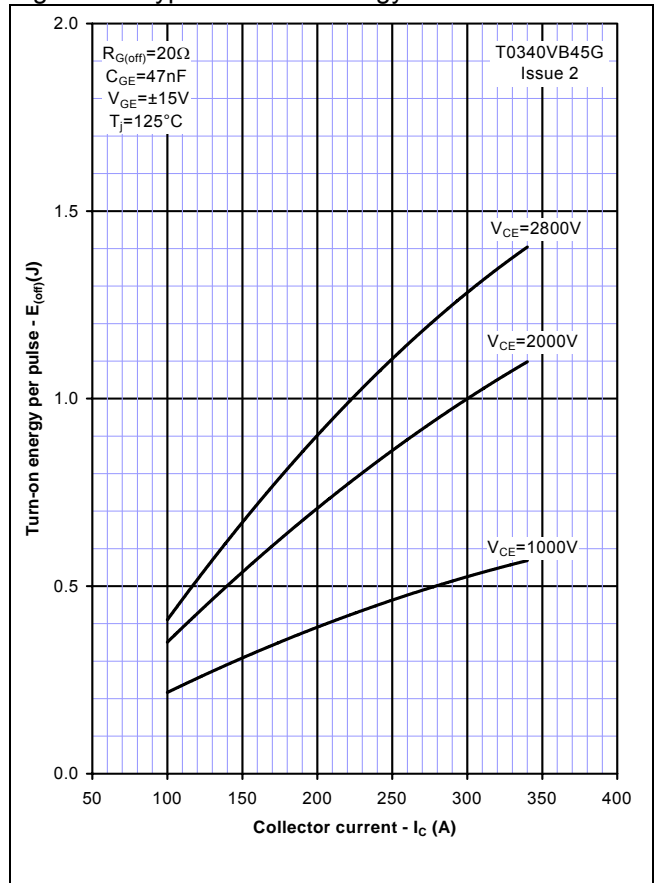

Figure 9 – Turn-off energy vs voltage

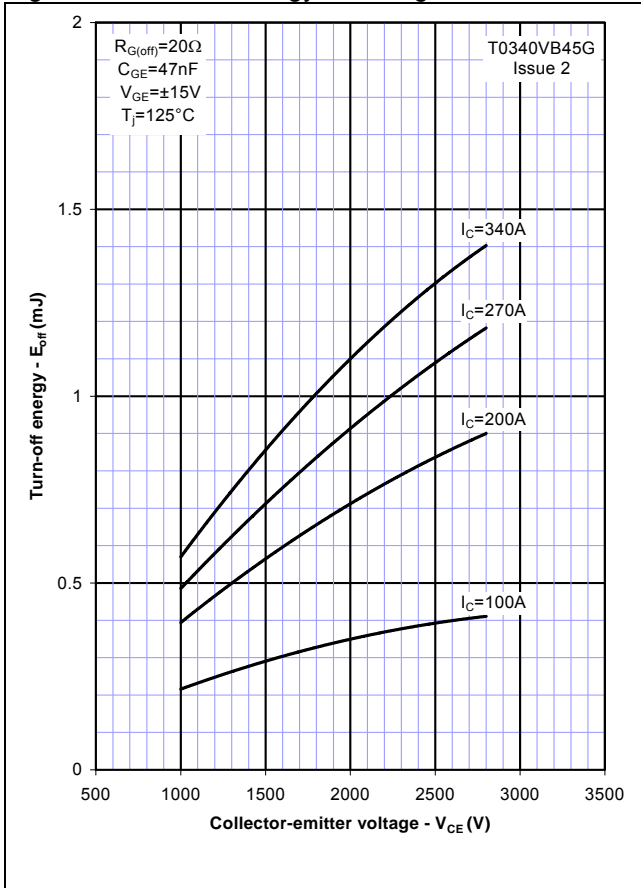

Figure 10 – Safe operating area

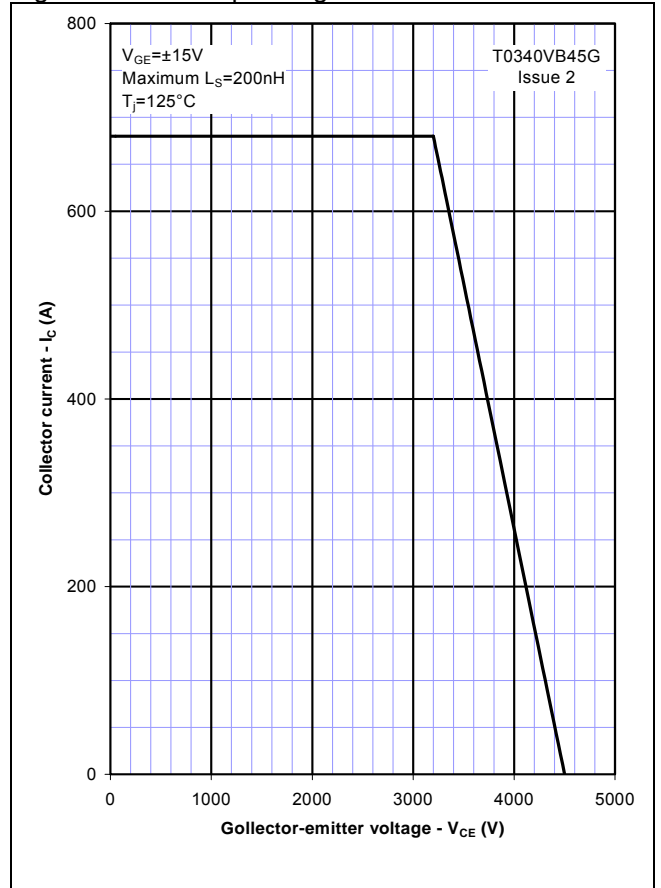

Figure 11 – Typical diode forward characteristics

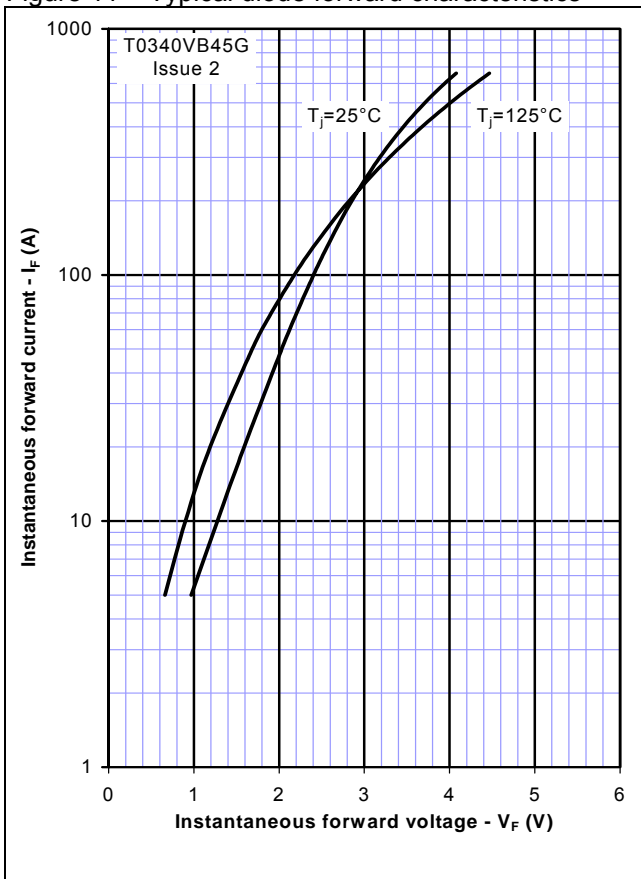

Figure 12 – Typical recovered charge

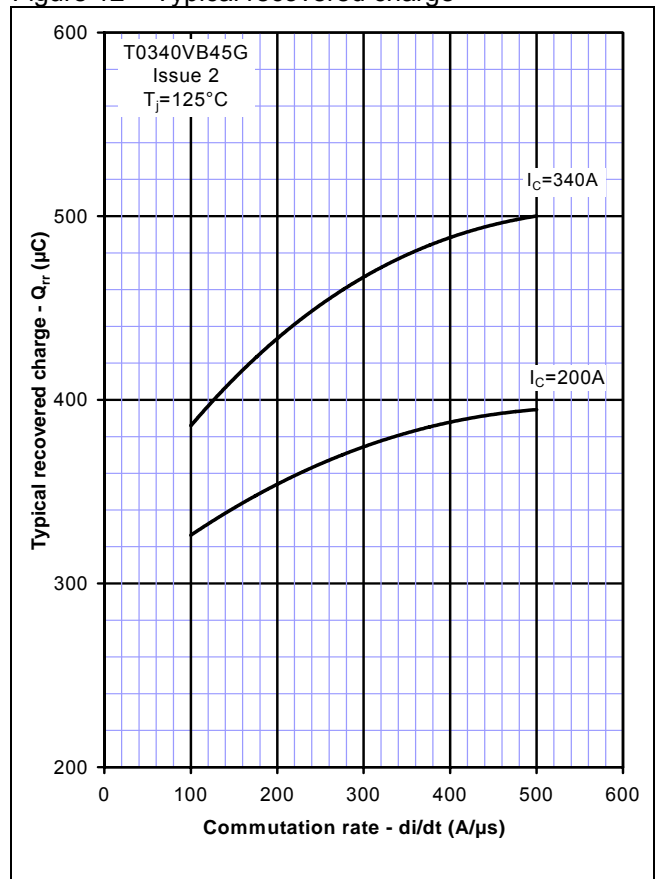

Figure 13 – Typical reverse recovery current

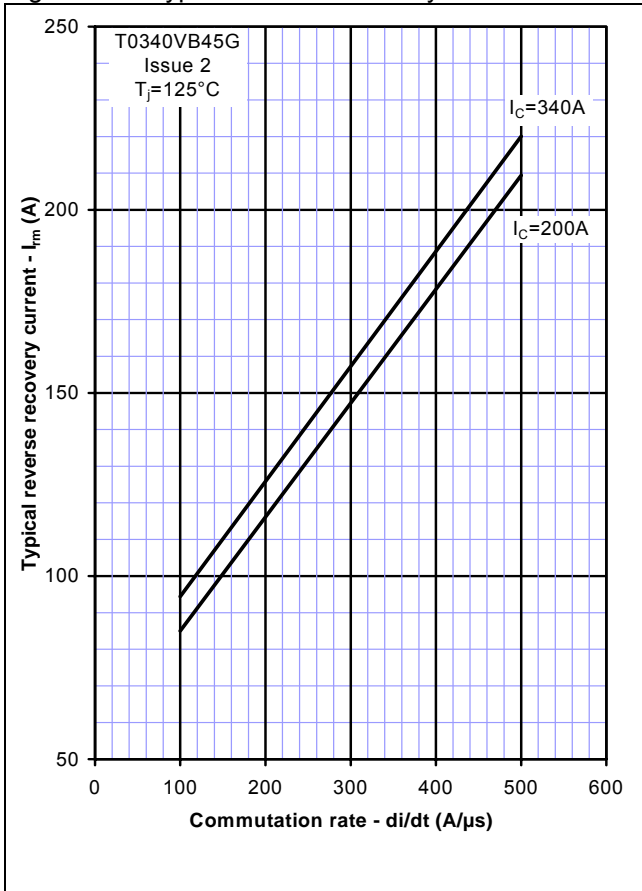

Figure 14 – Typical reverse recovery time

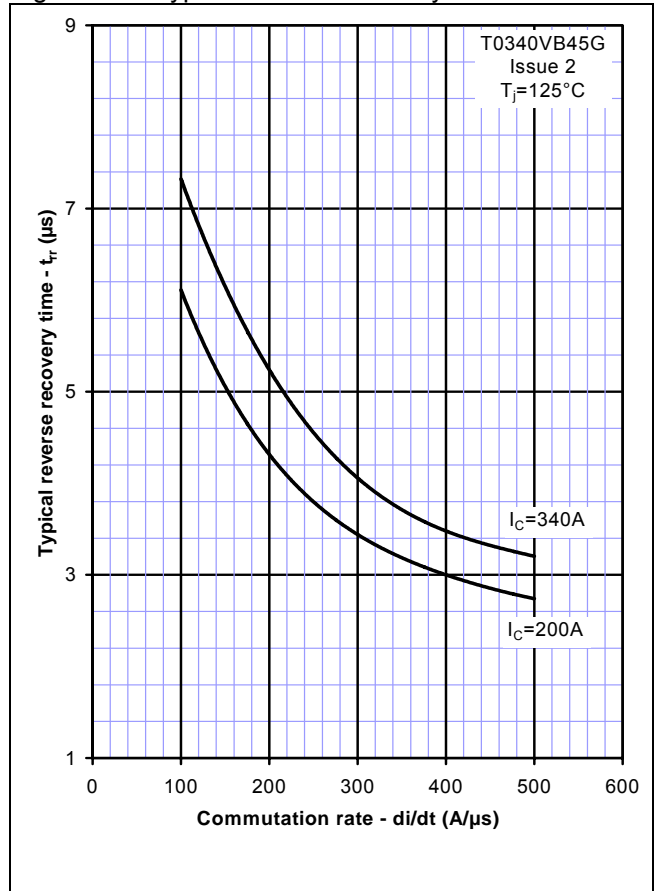

Figure 15 – Transient thermal impedance (IGBT)

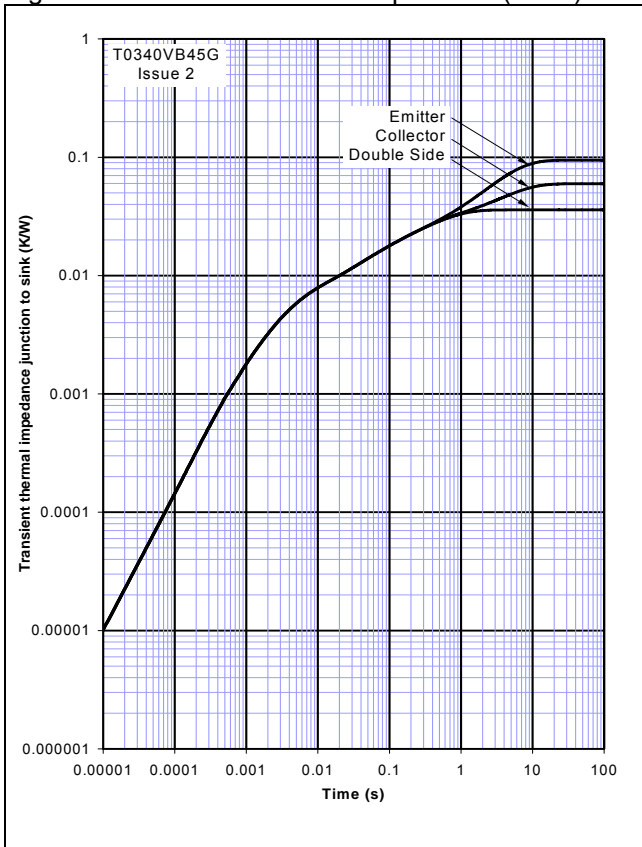
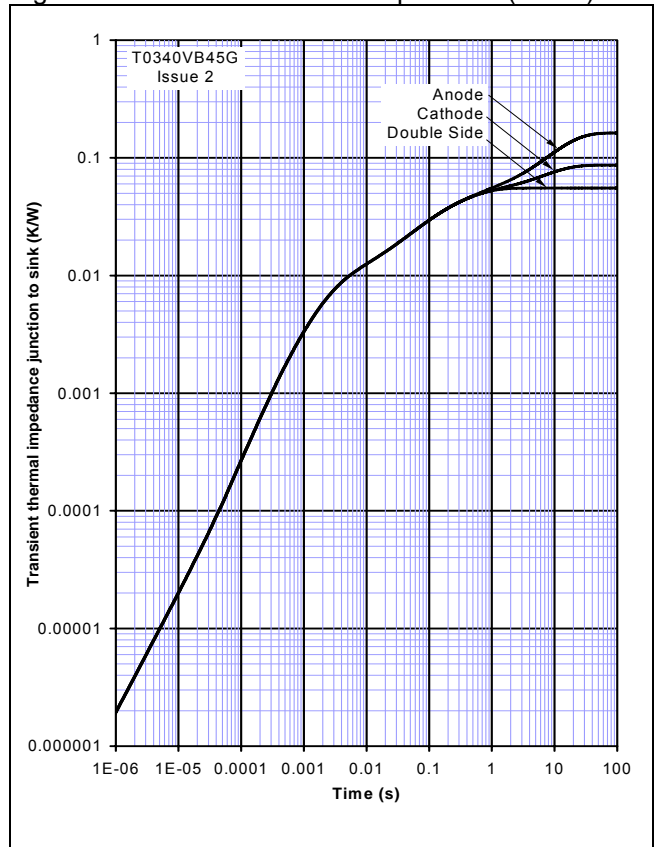
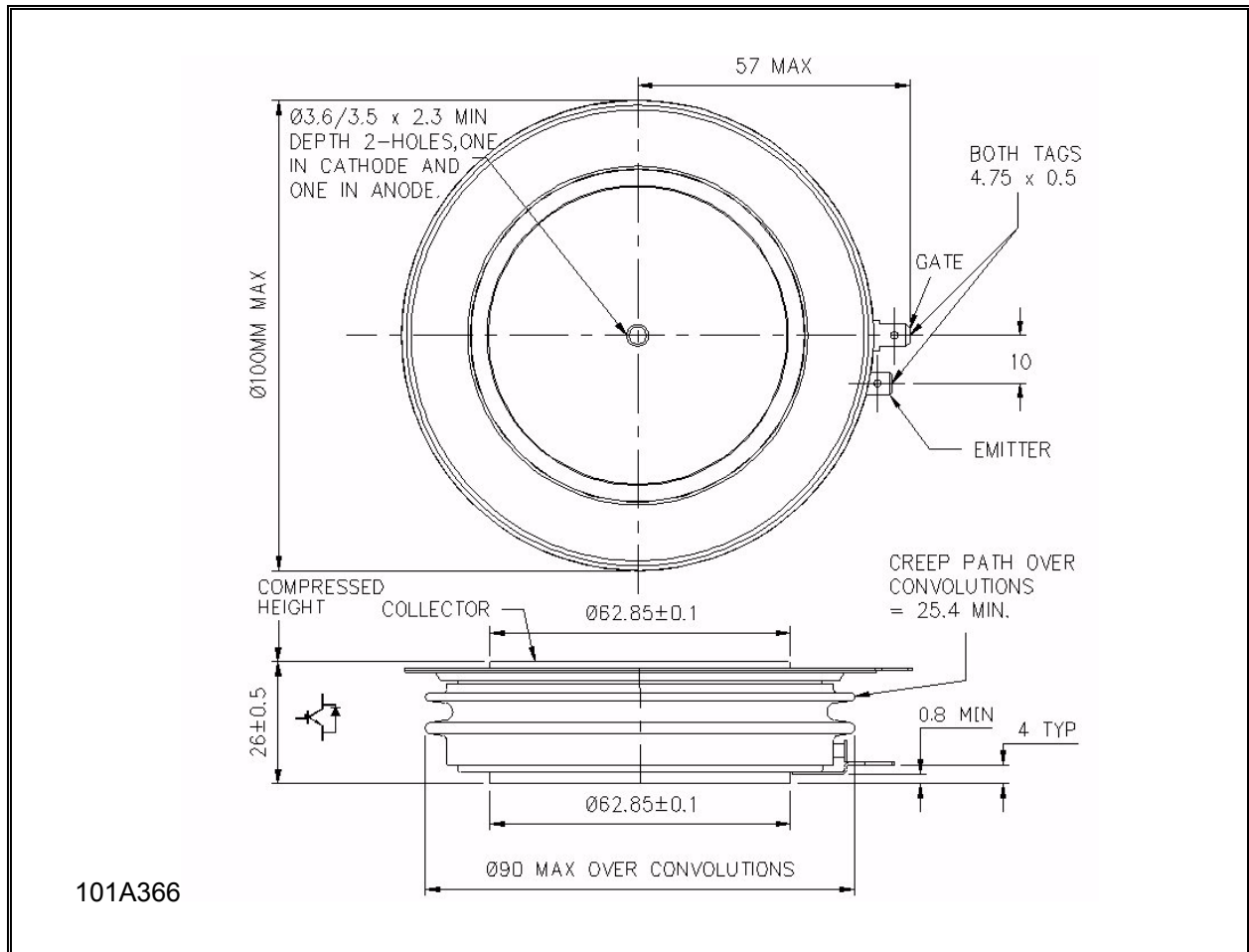

Figure 16 – Transient thermal impedance (Diode)



Outline Drawing & Ordering Information



101A366

ORDERING INFORMATION

(Please quote 10 digit code as below)

T0340	VB	45	G
Fixed type Code	Fixed Outline Code	Voltage Grade $V_{CES}/100$ 45	Fixed format code

Typical order code: T0340VB45G ($V_{CES} = 4500V$)

IXYS Semiconductor GmbH
Edisonstraße 15
D-68623 Lampertheim
Tel: +49 6206 503-0
Fax: +49 6206 503-627
E-mail: marcom@ixys.de



IXYS UK Westcode Ltd
Langley Park Way, Langley Park,
Chippenham, Wiltshire, SN15 1GE.
Tel: +44 (0)1249 444524
Fax: +44 (0)1249 659448
E-mail: sales@ixysuk.com

IXYS Corporation
1590 Buckeye Drive
Milpitas CA 95035-7418
Tel: +1 (408) 457 9000
Fax: +1 (408) 496 0670
E-mail: sales@ixys.net

www.ixysuk.com

www.ixys.net

IXYS Long Beach
IXYS Long Beach, Inc
2500 Mira Mar Ave, Long Beach
CA 90815
Tel: +1 (562) 296 6584
Fax: +1 (562) 296 6585
E-mail: service@ixyslongbeach.com

The information contained herein is confidential and is protected by Copyright. The information may not be used or disclosed except with the written permission of and in the manner permitted by the proprietors IXYS UK Westcode Ltd.

© IXYS UK Westcode Ltd.

In the interest of product improvement, IXYS UK Westcode Ltd reserves the right to change specifications at any time without prior notice.

Devices with a suffix code (2-letter, 3-letter or letter/digit/letter combination) added to their generic code are not necessarily subject to the conditions and limits contained in this report.