



Document Version: 0.3

Date: 2004/11/03

Product Functional Specification

15 inch XGA Color TFT-LCD Module Model Name: T150XG01 V.0

(*) Preliminary Specification

() Final Specification

Official UK Representative



Unit A Merlin Centre, Gatehouse Close,
Aylesbury, HP19 8DP, ENGLAND

Tel.: +44 (0)1296-469770 Fax.: +44 (0)1296-469779
sales@displaze.com www.displaze.com

Please verify this is the latest information. E&OE

Note: This Specification is subject to change without notice.



Contents

No	ITEM
	COVER
	CONTENTS
	RECORD OF REVISION
1	GENERAL DESCRIPTION
2	ABSOLUTE MAXIMUM RATINGS
3	ELECTRICAL SPECIFICATIONS
3-1	SIGNAL ELECTRONIC CHARACTERISTIC
3-2	INTERFACE CONNECTIONS
3-3	SIGNAL TIMING SPECIFICATIONS
3-4	SIGNAL TIMING WAVEFORMS
3-5	COLOR INPUT DATA REFERNECE
3-6	POWER ON/OFF SEQUENCE
3-7	FUNCTION BLOCK DIAGRAM
4	OPTICAL SFECIFICATIONS
5	MECHANICAL CHARACTERISTICS
6	RELIABLITY TEST ITEMS
7	INTERNATIONAL STANDARDS
7-1	SAFETY
7-2	EMC
8	PACKING
9	PRECAUTIONS



Record of Revision

Version	Date	Chapter	Description	Remark
0.0	Aug. 05,'04	5	First Draft (Preliminary)	
0.1	Aug. 20,'04	3-3	To update Timing Spec.	
0.2	Sep. 06,'04	1	Contrast: 450:1(typ.) à 500:1(typ.)	
			Brightness: 450nit@6.0mA à 450nit@6.5mA	
			Add Viewing Angle Item à 80/80/80/60 (CR>10)	
		3-1	Lamp power consumption	
0.3	Nov. 03,'04'	1	Color Gamut 65%à60%	
		4	Uniformity of Luminance updated	
			Response Time updated	
			Color Coordinates updated	
			Viewing Angle updated à 80/80/80/55 (CR>10)	
			Optical test condition updated	



1. General Description

This specification applies to the 15.0 inch Color TFT-LCD Module T150XG01.

This module supports the XGA (1024(H) x 768(V)) screen format and 16.2M colors (6-bits + FRC).

All input signals are 1 channel LVDS interface compatible.

All the design rules of this module can correspond to PSWG standard.

This module is without any inverter card for backlight.

Features

- XGA 1024(H) x 768(V) resolution
- 50,000 hours lamp life
- 4 CCFL (Cold Cathode Fluorescent Lamp)
- High brightness, High contrast ratio
- Wide viewing angle
- Fast response Time
- Low power consumption

Application

Person TV

Multi-function media



* General Information

The following items are characteristics summary on the table 25 °C condition:

Items	Specification	Unit	Note
Active Screen Size	15.0 inches		38.1cm diagonal
Display Area	304.128(H) × 228.096(V)	mm	
Outline Dimension	326.5(H) × 253.5(V) × 14.4(D) (typ.)	mm	Without inverter
Resolution	1024(R,G,B×3) x 768	Pixels	
Pixel Pitch	0.297 x 0.297		
Pixel Arrangement	RGB vertical stripe		
Display mode	TN mode, Normally White		
Display Colors	16.2M (6-bit + FRC for R,G,B)	Colors	
Typical White Luminance	450 nit (typ.) @ 6.5mA	[cd/m ²]	
Contrast Ratio	500:1(typ.)		
Color Gamut	60%(typ.) of NTSC		
Response Time	16ms(typ.) (Tr+Tf)	ms	
Viewing Angle (L/R/U/D)	80/80/80/55		CR>10
Power Consumption	22 W (typ.)(VDD line +CCFL line)	W	@6.5mA
Electronic Interface	1ch LVDS (8 bit)		
Frame rate	60Hz(typ.), 75Hz(max.)	Hz	
Weight	1350(max)	g	
Surface Treatment	Hard-Coating 3H, AG		



2. Absolute Maximum Ratings

The following table shows the maximum values which, if exceeded (8.5mA), may cause faulty operation or damage to the unit.

Item	Symbol	Min.	Max.	Unit	Note
Logic/LCD Drive Voltage	VDD	-0.3	+3.6	【Volt】	
Input Voltage of Signal	Vin	-0.3	+3.6	【Volt】	
CCFL Current	ICFL	+2.5	+8.5	【mA】 rms	
Operating Temperature	T _{OP}	0	+50	°C	Note 1
Storage Temperature	H _{ST}	-20	+60	°C	Note 1
Operating Humidity	H _{OP}	20	85	%RH	Note 1
Storage Humidity	H _{ST}	10	90	%RH	Note 1
Vibration		-	1/10-200	【G/Hz】	
Shock		-	50/20	【G/ms】	Half sine wave

Note: 1. Temperature and relative humidity range are shown in the figure below. Wet bulb temperature should be 39°C and No condensation.

Wet bulb temperature chart

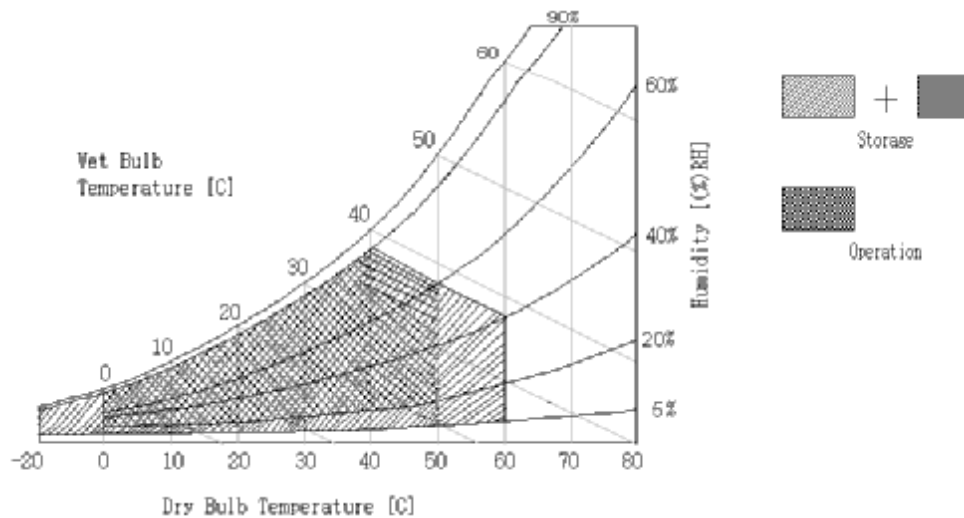



3. Electrical Specification

3-1 Signal Electrical Characteristics

Each signal characteristics are as follows:

Parameter	Symbol	Values			Unit	Notes
		Min	Typ	Max		
LCD:						
Power Supply Input Voltage	Vcc	3.0	3.3	3.6	Vdc	
Power Supply Input Current	Icc	-	1.0	1.3	A	1
Power Consumption	Pc	-	3.3	4.3	Watt	1
Allowable Ripple & Noise	VDDns	-	-	100	mVp-p	
Inrush Current	I _{RUSH}	-	-	TBD	A _{peak}	1
Lamp Power Consumption		-	17.7	24.7	W	2
Life Time		50,000	60,000	-	hr	3



3-2 Interface Connections

- LCD connector (CN1): DF-14H-20P-1.25H (Hirose) or equivalent
- LVDS Transmitter : DS90C385 (N.S.) or THC63LVDM83A (THINE) or equivalent

Pin No.	Symbol	Function
1	VDD	Power Supply +3.3V
2	VDD	Power Supply +3.3V
3	GND	Power Ground
4	GND	Power Ground
5	Rx0-	- LVDS Receiver Signal (R0-R5, G0)
6	Rx0+	+ LVDS Receiver Signal (R0-R5, G0)
7	GND	Ground
8	Rx1-	- LVDS Receiver Signal (G0-G5, B0-B1)
9	Rx1+	+ LVDS Receiver Signal (G0-G5, B0-B1)
10	GND	Ground
11	Rx2-	- LVDS Receiver Signal (B2-B5, HS, VS, DE)
12	Rx2+	+ LVDS Receiver Signal (B2-B5, HS, VS, DE)
13	GND	Ground
14	RxCLK2-	- LVDS Receiver Clock Signal
15	RxCLK2+	+ LVDS Receiver Clock Signal
16	GND	Ground
17	Rx3-	- LVDS Receiver Signal (R6-R7, G6-G7, B6-B7)
18	Rx3+	+ LVDS Receiver Signal (R6-R7, G6-G7, B6-B7)
19	GND	Ground
20	NC	Reserved

Note: All GND (ground) pins should be connected together and to Vss, which should also be connected to the LCD's metal frame. All Vcc (power input) pins should be connected together.



8-bit input LVDS data format

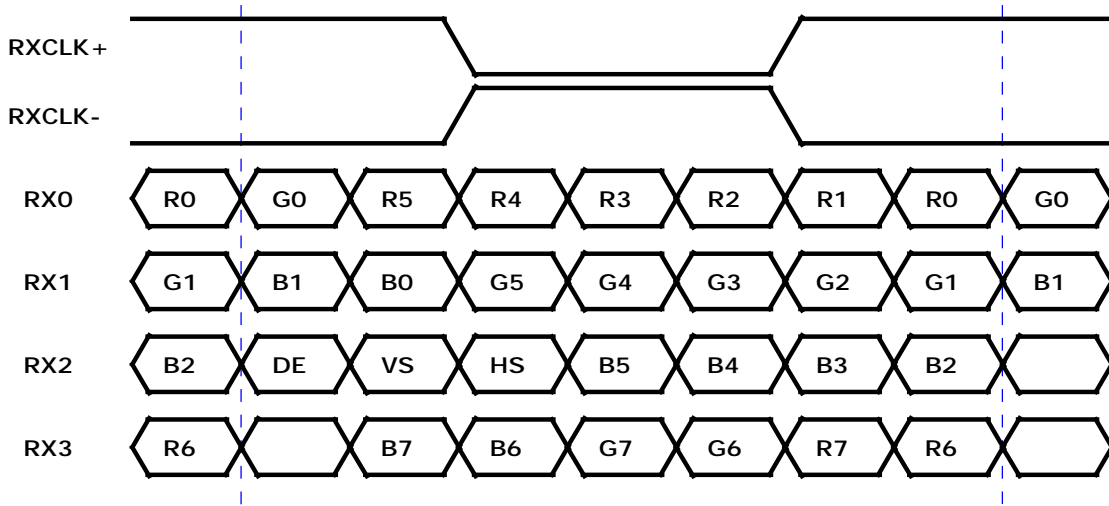

Note : Since this is DE only mode, please set the HS and VS to logic 1.

Backlight Connector Pin Configuration

Pin#	Signal Name
1	Lamp High Voltage
2	Ground

Electrical specification (Lamp spec.)

Symbol	Parameter	Min	Typ	Max	Units	Condition
IRCFL	CCFL operation range	3.0	6.5	8.5	[mA] rms	(Ta=25°C)
ICFL	CCFL Inrush current	-	-	20	[mA]	(Ta=25°C)
FCFL	CCFL Frequency	40	55	60	[KHz]	(Ta=25°C)
ViCFL	CCFL Ignition Voltage	1000	-	-	[Volt] rms	(Ta=25°C) (Reference)
ViCFL	CCFL Ignition Voltage	1300	-	-	[Volt] rms	(Ta= 0°C) (Reference)
VCFL	CCFL Discharge Voltage	-	680	725	[Volt] rms	(Ta=25°C)
PCFL	CCFL Power consumption @ 6.5 mA (excluding inverter)	-	17.7	24.7	[Watt]	(Ta=25°C)

Note1: CCFL Frequency should be carefully determined to avoid interference between inverter and TFT LCD

Note2: Calculate value for reference (IRCFL x VCFL x 4 = PCFL)

Note3: CCFL inverter should be able to give out a power that has a generating capacity of over 1300 voltage.
Lamp units need 1300 voltage minimum for ignition

Note4: CCFL life time 50,000 hr at 6.5 mA, it's defined as when the brightness is reduced by half.
It's recommended not to exceed 6.5 mA for CCFL life time concern and it's prohibited to exceed 8.5mA for safety concern



3-3 Signal Timing Specifications

This is the signal timing required at the input of the User connector. All of the interface signal timing should be satisfied with the following specifications for its proper operation.

Timing Table (DE mode only)

Parameter		Symbol	Min.	Typ.	Max.	Unit
Clock frequency		$1/T_{\text{Clock}}$	50	65	81	MHz
Vertical Section	Period	T_V	776	806	1024	T_{Line}
	Active	T_{VD}	768	768	768	
	Blanking	T_{VB}	8	38	256	
Horizontal Section	Period	T_H	1054	1344	2048	T_{Clock}
	Active	T_{HD}	1024	1024	1024	
	Blanking	T_{HB}	30	320	1024	

3-4 Signal Timing Waveforms

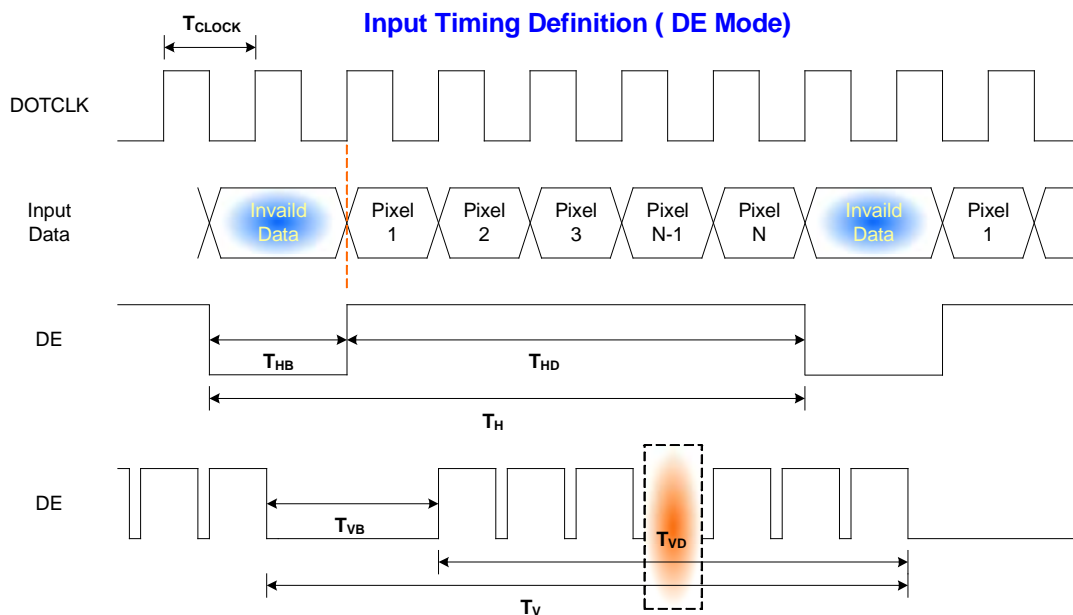

Note : Since this is DE only mode, please set the HS and VS to logic 1.



3-5 Color Input Data Reference

The brightness of each primary color (red, green and blue) is based on the 8 bit gray scale data input for the color; the higher the binary input, the brighter the color. The table below provides a reference for color versus data input.

COLOR DATA REFERENCE

Color		Input Color Data																							
		RED								GREEN								BLUE							
		MSB				LSB				MSB				LSB				MSB				LSB			
		R7	R6	R5	R4	R3	R2	R1	R0	G7	G6	G5	G4	G3	G2	G1	G0	B7	B6	B5	B4	B3	B2	B1	B0
Basic Color	Black	0	0	0	0	0	0	0	0	0	0	0	0	0	0	0	0	0	0	0	0	0	0	0	0
	Red(255)	1	1	1	1	1	1	1	1	0	0	0	0	0	0	0	0	0	0	0	0	0	0	0	
	Green(255)	0	0	0	0	0	0	0	0	1	1	1	1	1	1	1	0	0	0	0	0	0	0	0	
	Blue(255)	0	0	0	0	0	0	0	0	0	0	0	0	0	0	0	1	1	1	1	1	1	1	1	
	Cyan	0	0	0	0	0	0	0	0	1	1	1	1	1	1	1	1	1	1	1	1	1	1	1	
	Magenta	1	1	1	1	1	1	1	1	0	0	0	0	0	0	0	0	0	1	1	1	1	1	1	
	Yellow	1	1	1	1	1	1	1	1	1	1	1	1	1	1	1	0	0	0	0	0	0	0	0	
	White	1	1	1	1	1	1	1	1	1	1	1	1	1	1	1	1	1	1	1	1	1	1	1	
RED	RED(000)	0	0	0	0	0	0	0	0	0	0	0	0	0	0	0	0	0	0	0	0	0	0	0	
	RED(001)	0	0	0	0	0	0	0	1	0	0	0	0	0	0	0	0	0	0	0	0	0	0	0	

	RED(254)	1	1	1	1	1	1	1	0	0	0	0	0	0	0	0	0	0	0	0	0	0	0	0	
	RED(255)	1	1	1	1	1	1	1	1	0	0	0	0	0	0	0	0	0	0	0	0	0	0	0	
GREEN	GREEN(000)	0	0	0	0	0	0	0	0	0	0	0	0	0	0	0	0	0	0	0	0	0	0	0	
	GREEN(001)	0	0	0	0	0	0	0	0	0	0	0	0	0	0	0	0	1	0	0	0	0	0	0	

	GREEN(254)	0	0	0	0	0	0	0	0	1	1	1	1	1	1	1	0	0	0	0	0	0	0	0	
	GREEN(255)	0	0	0	0	0	0	0	0	1	1	1	1	1	1	1	0	0	0	0	0	0	0	0	
BLUE	BLUE(000)	0	0	0	0	0	0	0	0	0	0	0	0	0	0	0	0	0	0	0	0	0	0	0	
	BLUE(001)	0	0	0	0	0	0	0	0	0	0	0	0	0	0	0	0	0	0	0	0	0	0	1	

	BLUE(254)	0	0	0	0	0	0	0	0	0	0	0	0	0	0	0	0	1	1	1	1	1	1	0	
	BLUE(255)	0	0	0	0	0	0	0	0	0	0	0	0	0	0	0	1	1	1	1	1	1	1	1	



3-6 Power On/Off Sequence

Vin and lamp power on/off sequence are as follows. The timing of interface signal are shown in the table.

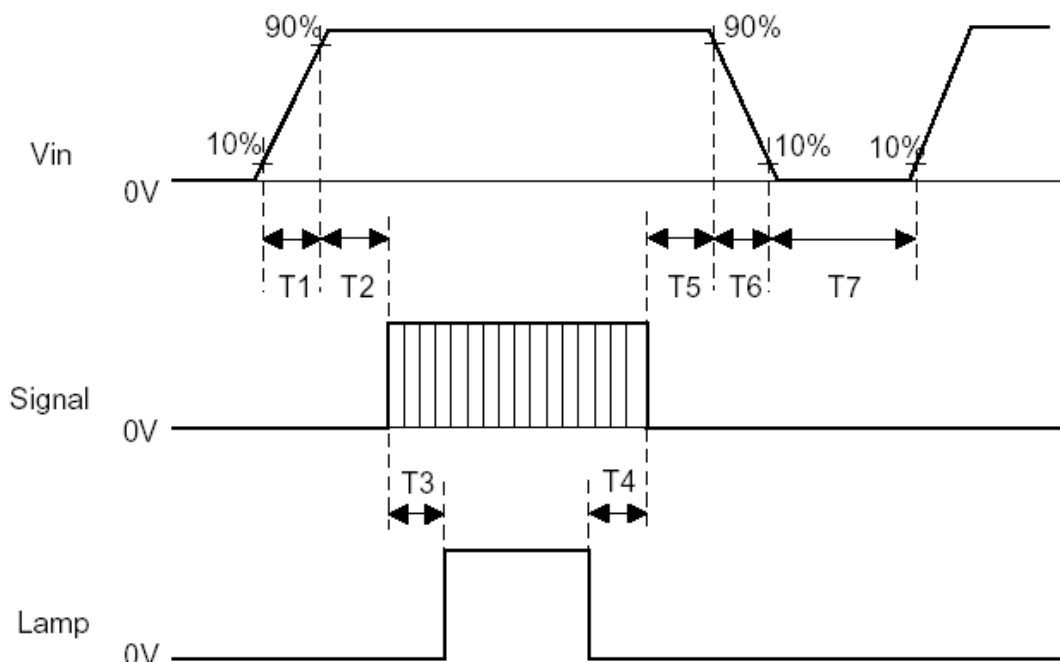

Symbol	Values			Unit
	Min	Typ	Max	
T1	0.5	-	10	【ms】
T2	0.5	25	50	【ms】
T3	200	-	-	【ms】
T4	200	-	-	【ms】
T5	0.5	16	50	【ms】
T6	0.5	-	10	【ms】
T7	1000	-	-	【ms】

Apply the lamp voltage within the LCD operating range. When the backlight turns on before the LCD operation or the LCD turns off before the backlight turns off, the display may momentarily become abnormal.

Caution : The above on/off sequence should be applied to avoid abnormal function in the display. In case of handling, make sure to turn off the power when you plug the cable into the input connector or pull the cable out of the connector.



3-7 Function Block Diagram

The following diagram shows the functional block of 15.0 inches Color TFT-LCD Module:

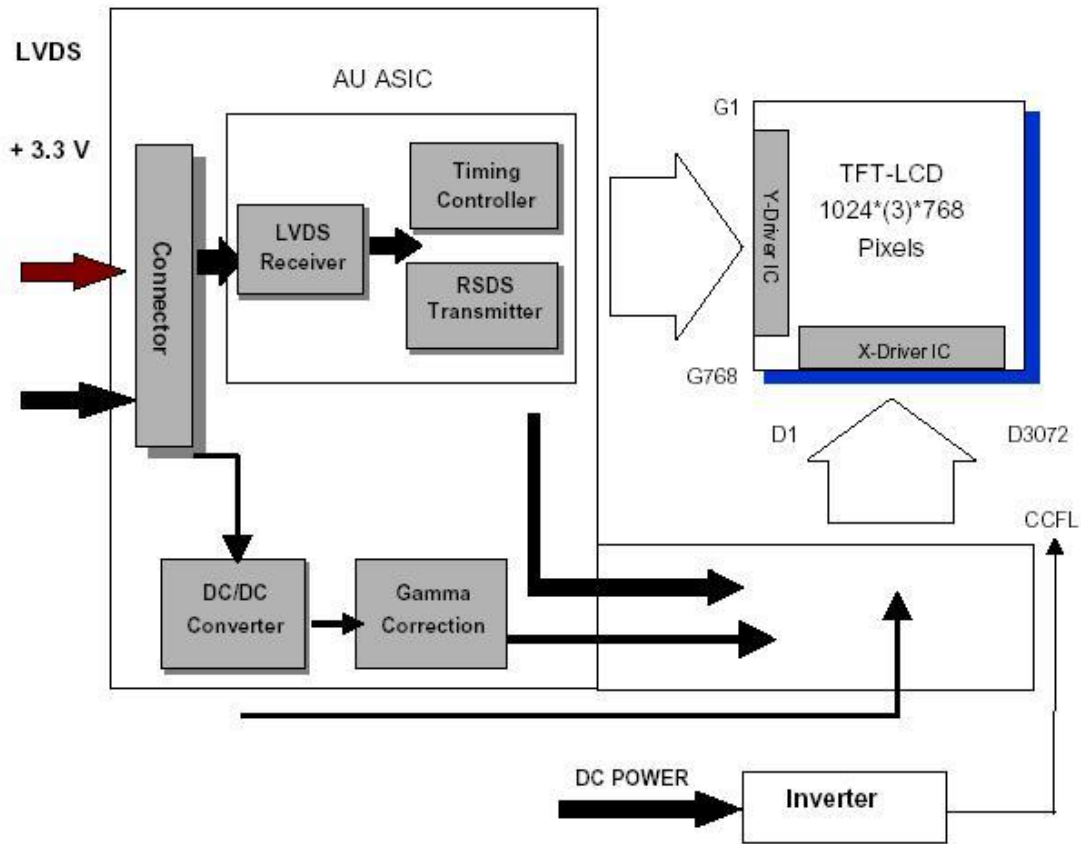

DF-14H-20P-1.25H (Hirose)
CWY20G-A0D1T (PTWO)

JST BHR-03VS-1



4. Optical Specification

Optical characteristics are determined after the unit has been 'ON' and stable for approximately 30 minutes in a dark environment at 25°C. The values specified are at an approximate distance 50cm from the LCD surface at a viewing angle of Φ and θ equal to 0°.

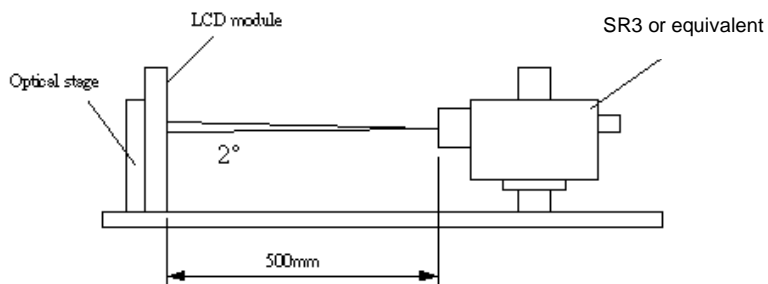

Fig.4-1 Optical measurement equipment and method

Parameter	Symbol	Values			Units	Notes
		Min.	Typ.	Max.		
Contrast Ratio	CR	400	500	-		1, 2
Surface Luminance, white	L_{WH}	350	450	-	cd/m ²	1, 3
Uniformity of Luminance	δ_{WHITE} 5 p	-	1.25	1.33		1, 4
Response Time	T_{on} (10%-90%)	-	4	5	ms	1, 5
	T_{off} (90%-10%)	-	12	20	ms	
	$T_{on}+T_{off}$	-	16	25	ms	
Color Coordinates		-	-	-		1
RED	R_x		0.604			
	R_y		0.347			
GREEN	G_x		0.283			
	G_y		0.583			
BLUE	B_x	TYP.	0.147	TYP.		
	B_y	-0.03	0.088	+0.03		
WHITE	W_x		0.279			
	W_y		0.291			
BLACK	D_x		0.233			
	D_y		0.212			
Viewing Angle (Contrast Ratio>10)		-	-	-		
x axis, right ($\varphi=0^\circ$)	θ_r	65	80	-	Degree	6
x axis, left ($\varphi=180^\circ$)	θ_l	60	80	-		
y axis, up ($\varphi=90^\circ$)	θ_u	60	80	-		
y axis, down ($\varphi=0^\circ$)	θ_d	50	55	-		



Note:

1. Optical test condition:

Test System	Detector	Inverter	Lamp Current	Warm Up
FPM-520	SR3	FINE QF132-V1	6.5 mA	30 min

2. Contrast Ratio (CR) is defined mathematically as:

$$\text{Contrast ratio (CR)} = \frac{\text{Brightness on the "white" state}}{\text{Brightness on the "black" state}}$$

3. Surface luminance is luminance value at point 1 across the LCD surface 50cm from the surface with all pixels displaying white. From more information see FIG 4-2. When $I_{BL} = 6.5\text{mA}$, $L_{WH} = 450\text{cd/m}^2$ (typ.) $L_{WH} = L_{on1}$, Where L_{on1} is the luminance with all pixels displaying white at center 1 location.

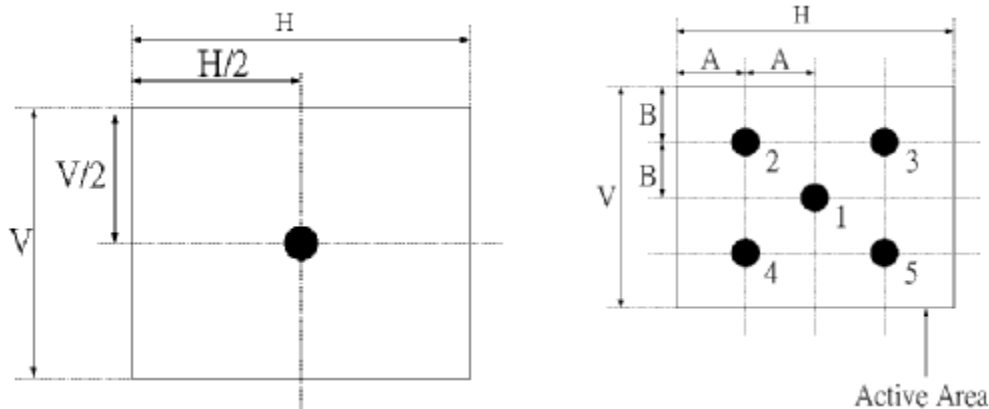

Fig.4-2 Optical measurement point

4. The variation in surface luminance, δ WHITE is defined (center of Screen) as:

$$\delta_{\text{WHITE}(5P)} = \frac{\text{Maximum}(L_{on1}, L_{on2}, \dots, L_{on5})}{\text{Minimum}(L_{on1}, L_{on2}, \dots, L_{on5})}$$

5. Definition of response time:

The output signals of photo-detector are measured when the input signals are changed from “Black” to “White” (falling time) and from “White” to “Black” (rising time), respectively. The response time interval between the 10% and 90% of amplitudes. Refer to figure as below.

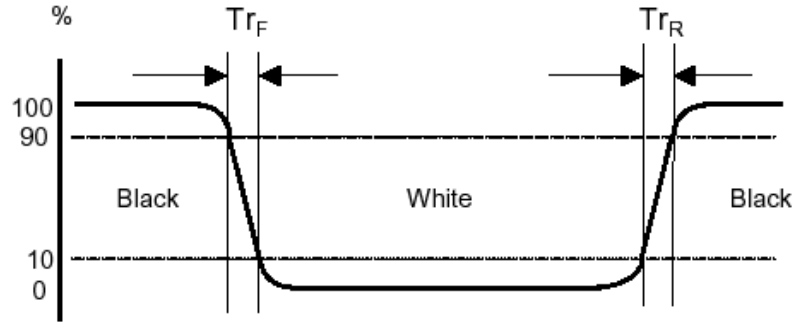

Fig.4-3 Response time

6. Viewing Angle:

To be measured with a viewing cone of 1° by Topcon luminance meter ELDIM EZ Contrast 160D. The Viewing angle is defined as the angle at which the contrast ratio is greater than 10. The angles are determined for the horizontal or x axis and the vertical or y axis with respect to the z axis, which is normal to the LCD surface. For more information see FIG4-4.

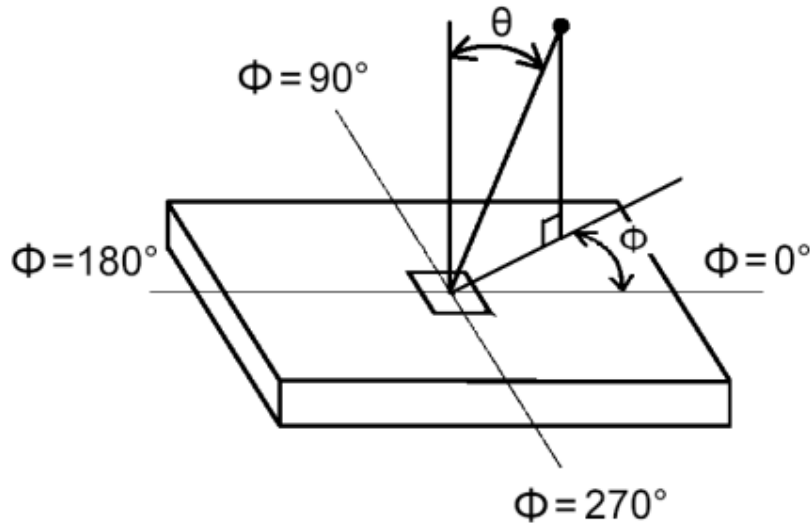

Fig.4-4 Viewing Angle Definition



5. Mechanical Characteristics

The contents provide general mechanical characteristics for the model T150XG01. In addition the figures in the next page are detailed mechanical drawing of the LCD.

Outline Dimension	Horizontal	326.5mm
	Vertical	253.5mm
	Depth	14.4mm(w/o inverter)
Active Display Area	Horizontal	304.128mm
	Vertical	228.096mm
Weight	1350g (typ.)	
Surface Treatment	Hard Coating (3H), AG	

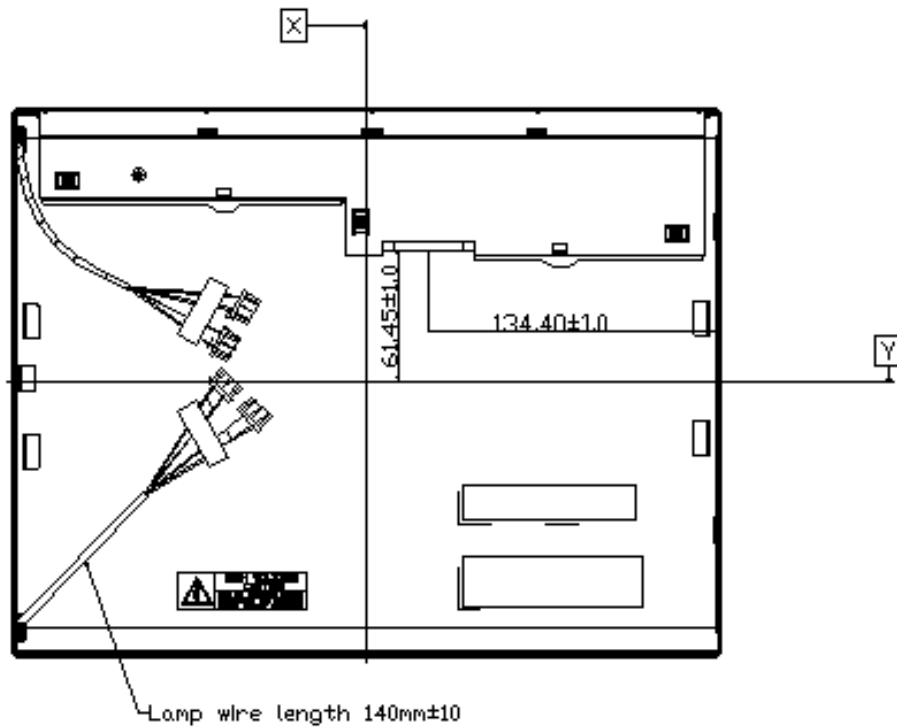
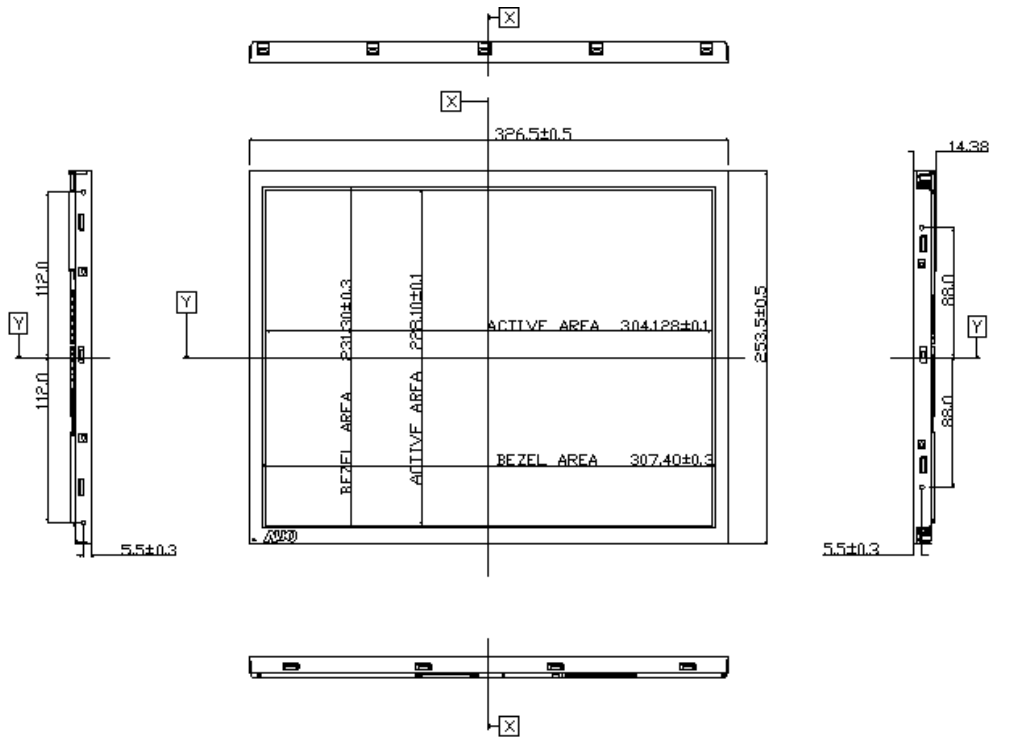

Fig.1 LCM outline dimension



6. Reliability Test Items

Environment test condition

No	Test Item	Condition	Remark
1	High temperature storage test	Ta=60°C 240h	Note 1,2,3
2	Low temperature storage test	Ta= -20°C 240h	Note 1,2,3
3	High temperature operation test	Ta=50°C 240h	Note 1,2,3
4	Low temperature operation test	Ta=0°C 240h	Note 1,2,3
5	High temperature & high humidity operation	50°C, 80%RH, 240Hrs (No condensation)	Note 1,2,3
6	Temperature cycling (non-operation)	-20°C~60°C 1H, 10mins, 1H, 5cycles	Note 1,2,3
7	Vibration test (non-operation)	Vibration level : 1G RMS Bandwidth : 10-200-10Hz Duration: X, Y, Z 120min One time each direction	Note 1,2,3
8	Shock test (non-operation)	Shock level: 50G Waveform: half sine wave, 20ms Direction: ±X, ±Y, ±Z One time each direction	Note 1,2,3
9	Electrostatic discharge (non-operation)	150 pF,150 Ω,10kV,1 second, 9 position on the panel, 10 times each place	Note 3

Note 1: Evaluation should be tested after storage at room temperature for one hour.

Note 2: There should be no change which might affect the practical display function when the display quality test is conducted under normal operating condition.

Note 3: Judgment: Function and display OK.



7. International Standard

7-1. Safety

- (1) UL1950 Third Edition, Underwriters Laboratories, Inc. Jan. 28, 1995
Standard for Safety of Information Technology Equipment Including electrical Business Equipment.
- (2) CAN/CSA C22.2 No. 950-95 Third Edition, Canadian Standards Association, Jan. 28, 1995
Standard for Safety of Information Technology Equipment Including Electrical Business Equipment.
- (3) EN60950 : 1992+A2: 1993+A2: 1993+C3: 1995+A4: 1997+A11: 1997
IEC 950: 1991+A1: 1992+A2: 1993+C3: 1995+A4:1996
European Committee for Electro technical Standardization (CENELEC)
EUROPEAN STANDARD for Safety of Information Technology Equipment Including Electrical Business Equipment.

7-2. EMC

- a) ANSI C63.4 "Methods of Measurement of Radio-Noise Emissions from Low-Voltage Electrical and Electrical Equipment in the Range of 9kHz to 40GHz. "American National standards Institute(ANSI), 1992
- b) C.I.S.P.R "Limits and Methods of Measurement of Radio Interface Characteristics of Information Technology Equipment." International Special committee on Radio Interference.
- c) EN 55022 "Limits and Methods of Measurement of Radio Interface Characteristics of Information Technology Equipment." European Committee for Electrotechnical Standardization. (CENELEC), 1998



8. Packing

Label Sample



Carton Label



LCD module set



cushion

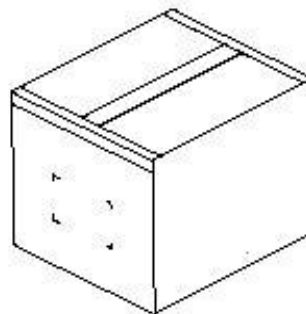
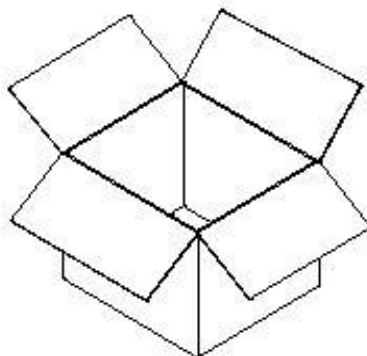
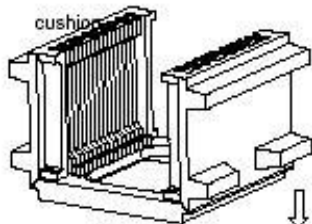

Notes:

1. Max Capacity: 10 LCD module/Carton
2. Max Weight: 14kg/Carton
3. The outside dimension of carton is 490(L)mmx390(W)mmx360(H)mm



9. PRECAUTIONS

Please pay attention to the followings when you use this TFT LCD module.

9-1 MOUNTING PRECAUTIONS

- (1) You must mount a module using holes arranged in four corners or four sides.
- (2) You should consider the mounting structure so that uneven force (ex. Twisted stress) is not applied to module. And the case on which a module is mounted should have sufficient strength so that external force is not transmitted directly to the module.
- (3) Please attach the surface transparent protective plate to the surface in order to protect the polarizer. Transparent protective plate should have sufficient strength in order to resist external force.
- (4) You should adopt radiation structure to satisfy the temperature specification.
- (5) Acetic acid type and chlorine type materials for the cover case are not desirable because the former generates corrosive gas of attacking the polarizer at high temperature and the latter causes circuit break by electro-chemical reaction.
- (6) Do not touch, push or rub the exposed polarizers with glass, tweezers or anything harder than HB pencil lead. And please do not rub with dust clothes with chemical treatment. Do not touch the surface of polarizer for bare hand or greasy cloth. (Some cosmetics are detrimental to the polarizer.)
- (7) When the surface becomes dusty, please wipe gently with absorbent cotton or other soft materials like chamois soaks with petroleum benzene. Normal-hexane is recommended for cleaning the adhesives used to attach front/ rear polarizers. Do not use acetone, toluene and alcohol because they cause chemical damage to the polarizer.
- (8) Wipe off saliva or water drops as soon as possible. Their long time contact with polarizer causes deformations and color fading.
- (9) Do not open the case because inside circuits do not have sufficient strength.

9-2 OPERATING PRECAUTIONS

- (1) The spike noise causes the mis-operation of circuits. It should be lower than following voltage: $V=\pm 200\text{mV}$ (Over and under shoot voltage)
- (2) Response time depends on the temperature. (In lower temperature, it becomes longer..)
- (3) Brightness depends on the temperature. (In lower temperature, it becomes lower.) And in lower temperature, response time (required time that brightness is stable after turned on) becomes longer.
- (4) Be careful for condensation at sudden temperature change. Condensation makes



damage to polarizer or electrical contacted parts. And after fading condensation, smear or spot will occur.

- (5) When fixed patterns are displayed for a long time, remnant image is likely to occur.
- (6) Module has high frequency circuits. Sufficient suppression to the electromagnetic interference shall be done by system manufacturers. Grounding and shielding methods may be important to minimize the interface.

9-3 ELECTROSTATIC DISCHARGE CONTROL

Since a module is composed of electronic circuits, it is not strong to electrostatic discharge. Make certain that treatment persons are connected to ground through wrist band etc. And don't touch interface pin directly.

9-4 PRECAUTIONS FOR STRONG LIGHT EXPOSURE

Strong light exposure causes degradation of polarizer and color filter.

9-5 STORAGE

When storing modules as spares for a long time, the following precautions are necessary.

- (1) Store them in a dark place. Do not expose the module to sunlight or fluorescent light. Keep the temperature between 5°C and 35°C at normal humidity.
- (2) The polarizer surface should not come in contact with any other object. It is recommended that they be stored in the container in which they were shipped.

9-6 HANDLING PRECAUTIONS FOR PROTECTION FILM

- (1) The protection film is attached to the bezel with a small masking tape. When the protection film is peeled off, static electricity is generated between the film and polarizer. This should be peeled off slowly and carefully by people who are electrically grounded and with well ion-blown equipment or in such a condition, etc.
- (2) When the module with protection film attached is stored for a long time, sometimes there remains a very small amount of glue still on the Bezel after the protection film is peeled off.
- (3) You can remove the glue easily. When the glue remains on the Bezel or its vestige is recognized, please wipe them off with absorbent cotton waste or other soft material like chamois soaked with normal-hexane.