



Insulated Gate Bi-Polar Transistor Type T1600GB45G

Absolute Maximum Ratings

	VOLTAGE RATINGS	MAXIMUM LIMITS	UNITS
V _{CES}	Collector – emitter voltage	4500	V
V _{DC link}	Permanent DC voltage for 100 FIT failure rate.	2800	V
V _{GES}	Peak gate – emitter voltage	±20	V

	RATINGS	MAXIMUM LIMITS	UNITS
I _C	DC collector current, IGBT	1600	A
I _{CRM}	Repetitive peak collector current, t _p =1ms, IGBT	3200	A
I _{F(DC)}	Continuous DC forward current, Diode	1600	A
I _{FRM}	Repetitive peak forward current, t _p =1ms, Diode	3200	A
I _{FSM}	Peak non-repetitive surge t _p =10ms, V _{RM} =60%V _{RRM} , Diode (Note 4)	30	kA
I _{FSM2}	Peak non-repetitive surge t _p =10ms, V _{RM} ≤10V, Diode (Note 4)	33	kA
P _{MAX}	Maximum power dissipation, IGBT (Note 2)	12.8	kW
P _D	Maximum power dissipation, Diode (Note 2)	8.13	kW
(di/dt) _{cr}	Critical diode di/dt (note 3)	3000	A/μs
T _j	Operating temperature range.	-40 to +125	°C
T _{stg}	Storage temperature range.	-40 to +125	°C

Notes: -

- 1) Unless otherwise indicated T_j = 125°C.
- 2) T_{sink} = 25°C, double side cooled.
- 3) Maximum commutation loop inductance 200nH.
- 4) Half-sinewave, 125°C T_j initial.

Characteristics

IGBT Characteristics

	PARAMETER	MIN	TYP	MAX	TEST CONDITIONS	UNITS
V _{CE(sat)}	Collector – emitter saturation voltage	-	2.75	3.2	I _C = 1600A, V _{GE} = 15V, T _j = 25°C	V
		-	3.50	3.9	I _C = 1600A, V _{GE} = 15V	V
V _{T0}	Threshold voltage	-	-	1.79	Current range: 530A – 1600A	V
r _T	Slope resistance	-	-	1.32		mΩ
V _{GE(TH)}	Gate threshold voltage	-	5.1	-	V _{CE} = V _{GE} , I _C = 170mA	V
I _{CES}	Collector – emitter cut-off current	-	45	70	V _{CE} = V _{CES} , V _{GE} = 0V	mA
I _{GES}	Gate leakage current	-	-	±20	V _{GE} = ±20V	μA
C _{ies}	Input capacitance	-	270	-	V _{CE} = 25V, V _{GE} = 0V, f = 1MHz	nF
t _{d(on)}	Turn-on delay time	-	2.2	-	I _C = 1600A, V _{CE} = 2800V, di/dt = 2700A/μs V _{GE} = ±15V, L _S = 200nH R _{G(ON)} = 4.3Ω, R _{G(OFF)} = 12Ω, C _{GE} = 133nF Integral diode used as freewheel diode (Note 3 & 4)	μs
t _{r(V)}	Rise time	-	4.4	-		μs
Q _{g(on)}	Turn-on gate charge	-	9	-		μC
E _{on}	Turn-on energy	-	12	-		J
t _{d(off)}	Turn-off delay time	-	4.8	-		μs
t _{f(l)}	Fall time	-	2.6	-		μs
Q _{g(off)}	Turn-off gate charge	-	10	-		μC
E _{off}	Turn-off energy	-	8.7	-		J
I _{SC}	Short circuit current	-	5000	-		V _{GE} = +15V, V _{CC} = 2800V, V _{CEmax} ≤ V _{CES} , t _p ≤ 10μs

Diode Characteristics

	PARAMETER	MIN	TYP	MAX	TEST CONDITIONS	UNITS
V _F	Forward voltage	-	3.3	3.6	I _F = 1600A, T _j = 25°C	V
		-	3.45	3.8	I _F = 1600A	V
V _{T0}	Threshold voltage	-	-	2.14	Current range 530A - 1600A	V
r _T	Slope resistance	-	-	1.04		mΩ
I _{rm}	Peak reverse recovery current	-	1270	-	I _F = 1600A, V _r = 2800V, V _{GE} = -15V, di/dt = 2700A/μs	A
Q _{rr}	Recovered charge	-	1960	-		μC
t _{rr}	Reverse recovery time, 50% chord	-	1.75	-		μs
E _r	Reverse recovery energy	-	2.03	-		J

Thermal Characteristics

	PARAMETER	MIN	TYP	MAX	TEST CONDITIONS	UNITS
R _{thJK}	Thermal resistance junction to sink, IGBT	-	-	7.8	Double side cooled	K/kW
		-	-	12.8	Collector side cooled	K/kW
		-	-	20.3	Emitter side cooled	K/kW
R _{thJK}	Thermal resistance junction to sink, Diode	-	-	12.3	Double side cooled	K/kW
		-	-	19.5	Cathode side cooled	K/kW
		-	-	35.7	Anode side cooled	K/kW
F	Mounting force	50	-	70	Note 2	kN
W _t	Weight	-	2	-		kg

Notes:-

- 1) Unless otherwise indicated T_j = 125°C.
- 2) Consult application note 2008AN01 for detailed mounting requirements
- 3) C_{GE} is additional gate – emitter capacitance added to output of gate drive
- 4) Figures 4 to 10 are obtained using integral diode as freewheeling diode

Curves

Figure 1 – Typical collector-emitter saturation voltage characteristics

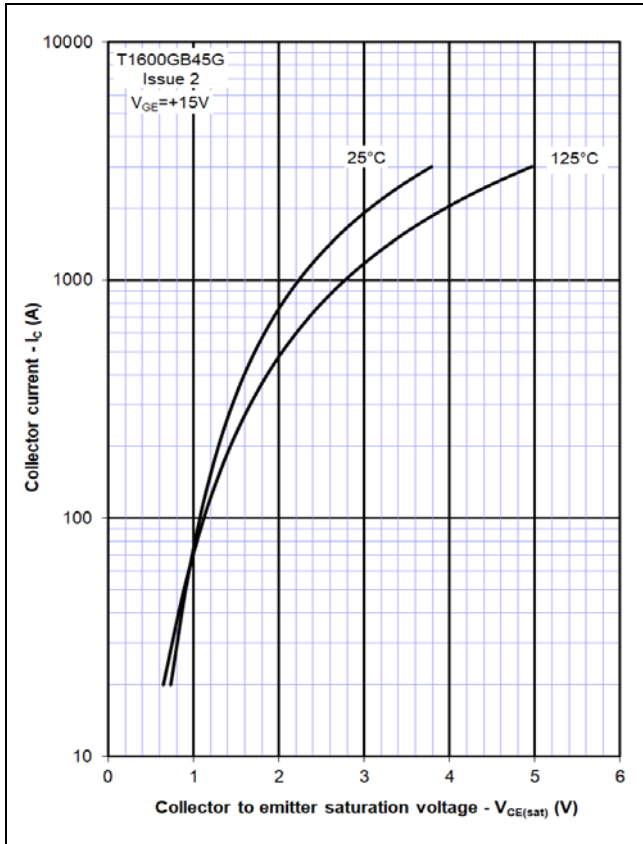

Figure 2 – Typical output characteristic

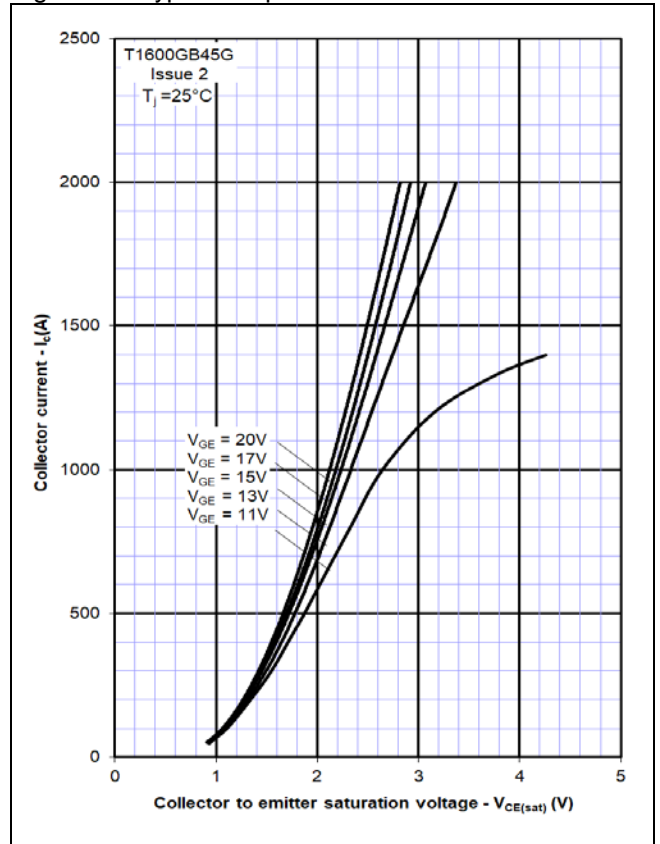

Figure 3 – Typical output characteristic

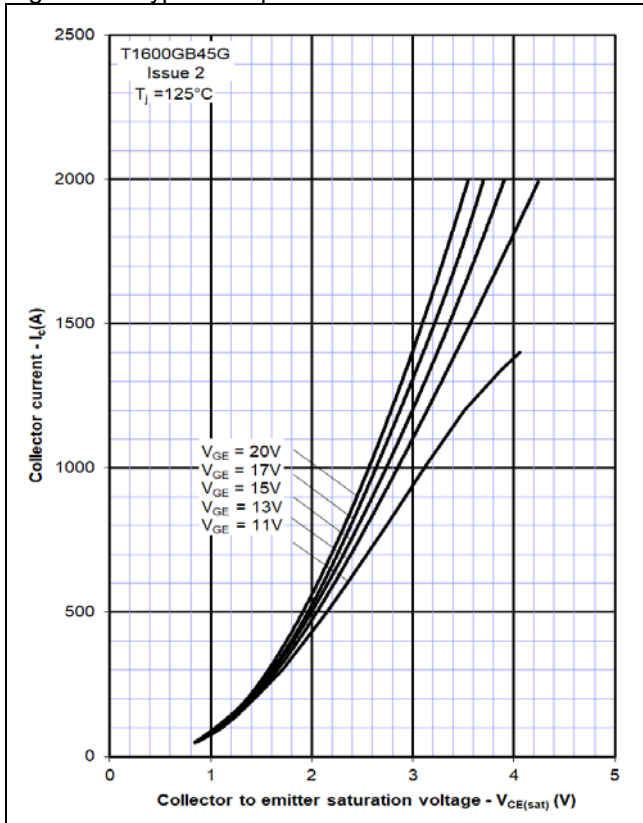

Figure 4 – Typical turn-on delay time vs gate resistance

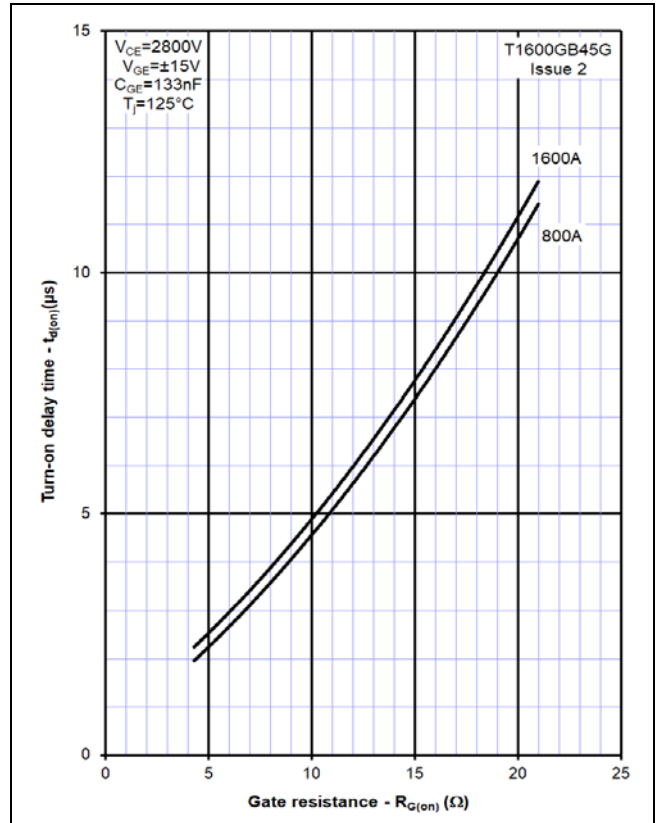

Figure 5 – Typical turn-off delay time vs. gate resistance

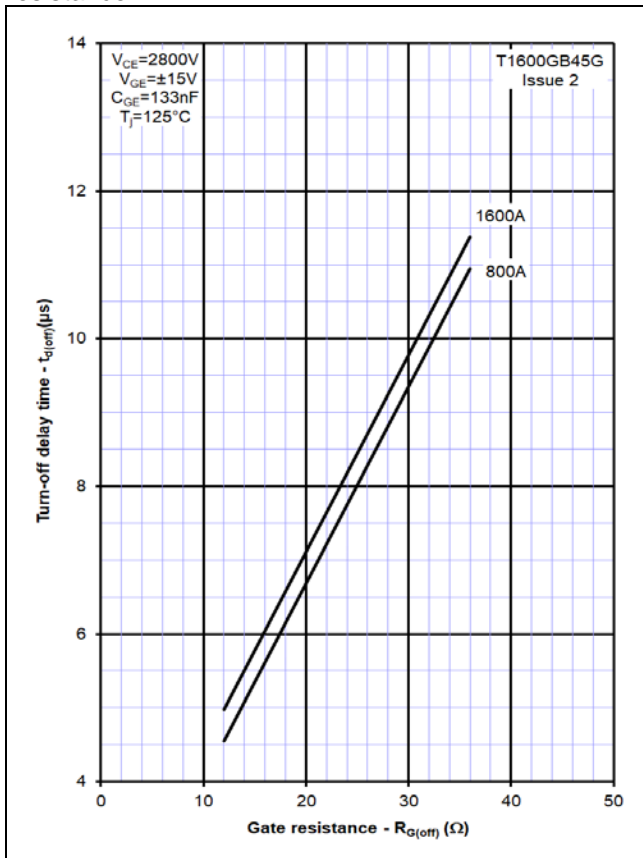

Figure 6 – Typical turn-on energy vs. collector current

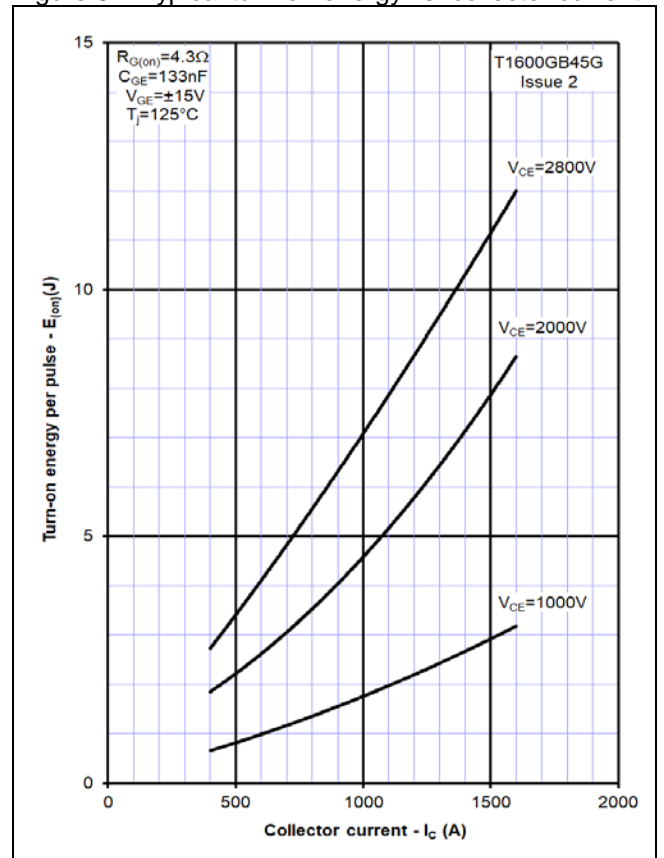

Figure 7 – Typical turn-on energy vs. di/dt

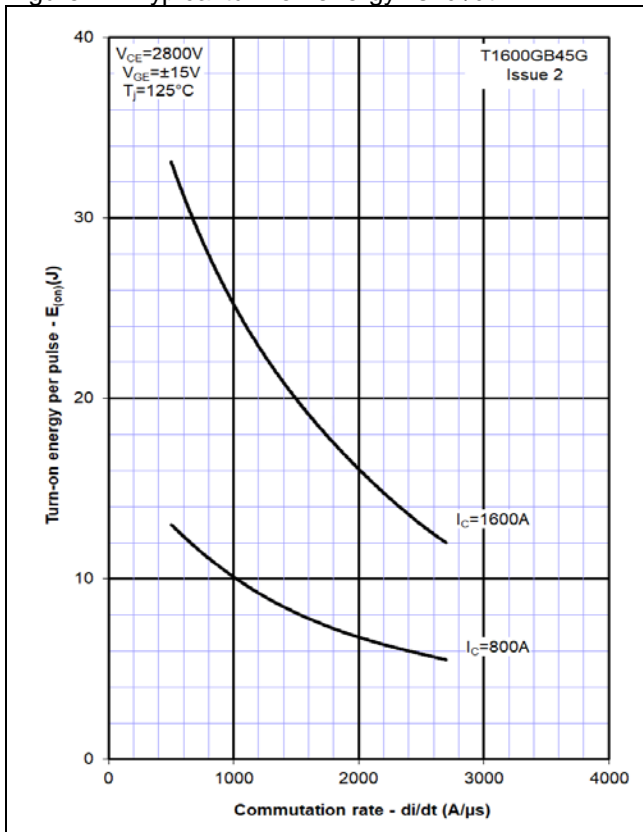

Figure 8 – Typical turn-off energy vs. collector current

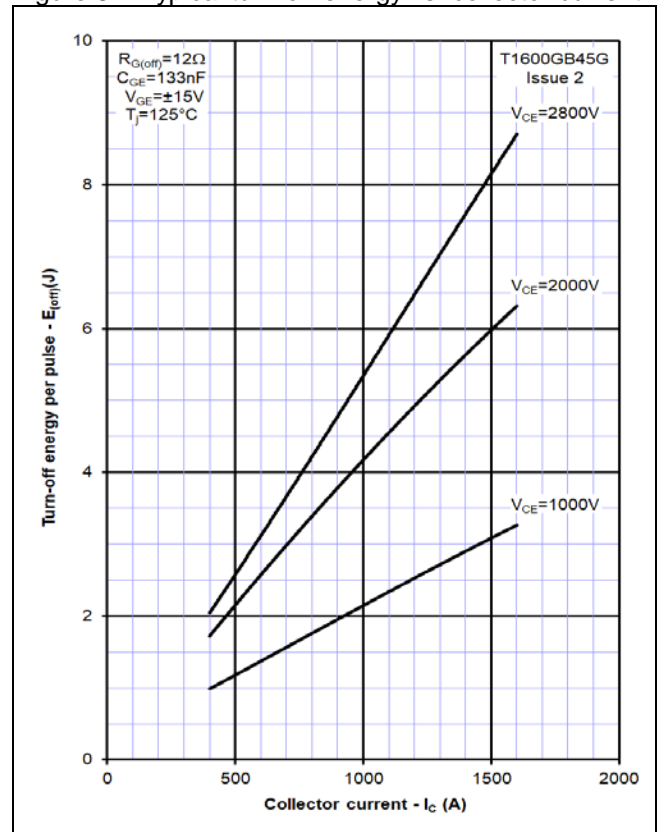

Figure 9 – Turn-off energy vs voltage

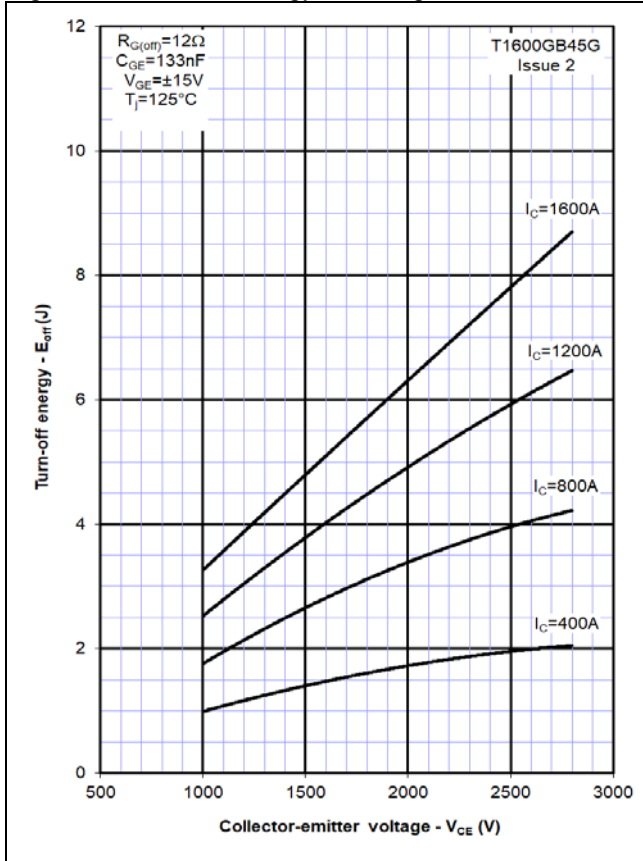

Figure 10 – Safe operating area (IGBT)

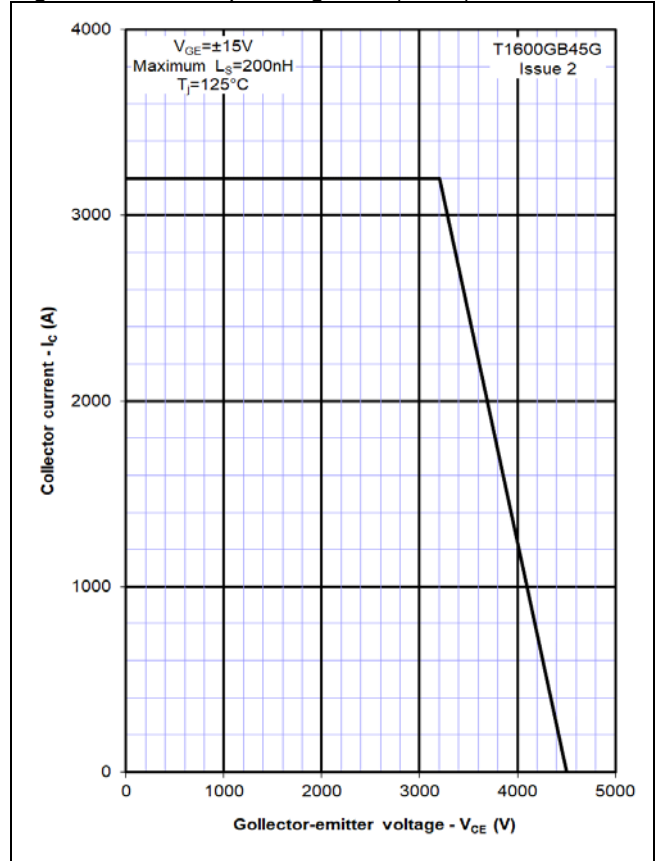

Figure 11 – Typical diode forward characteristics

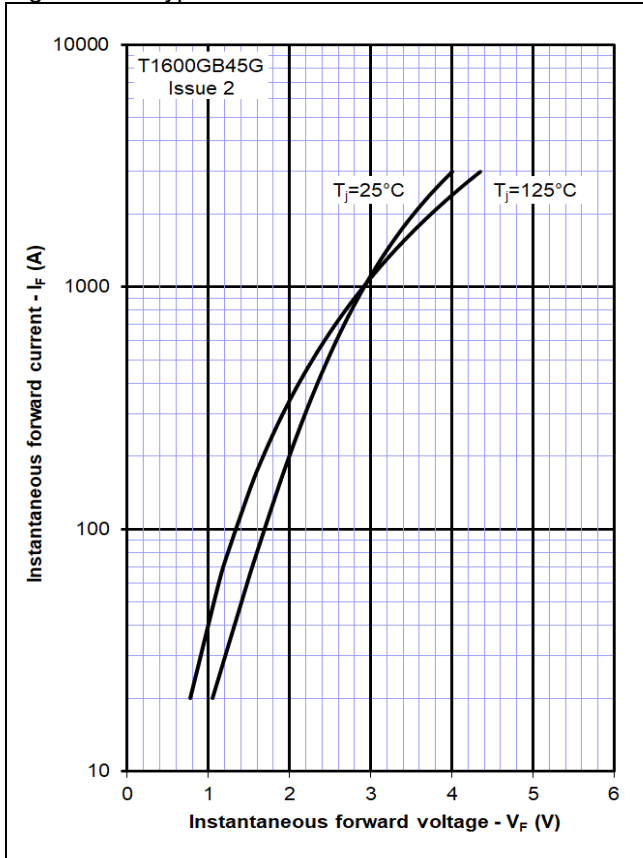

Figure 12 – Typical recovered charge

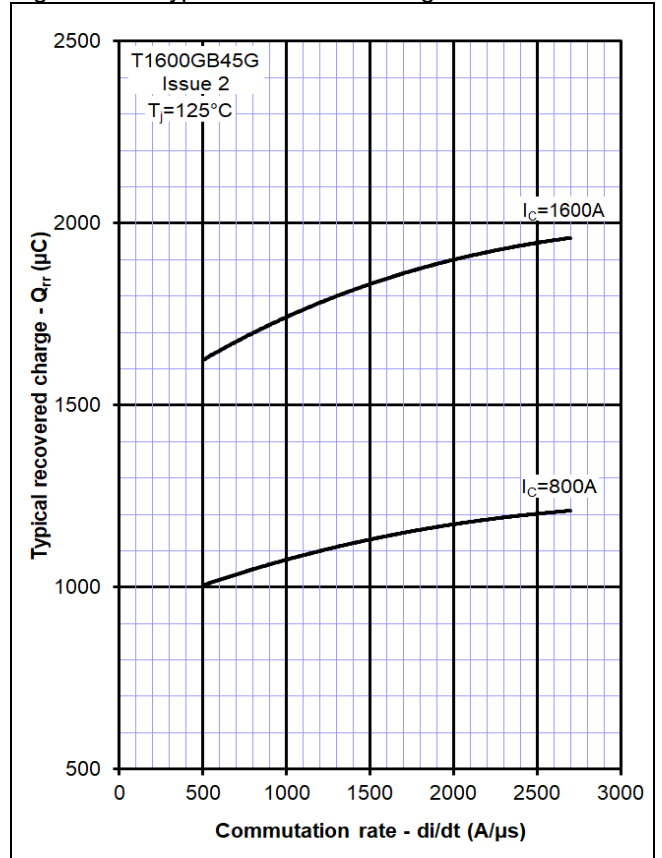

Figure 13 – Typical reverse recovery current

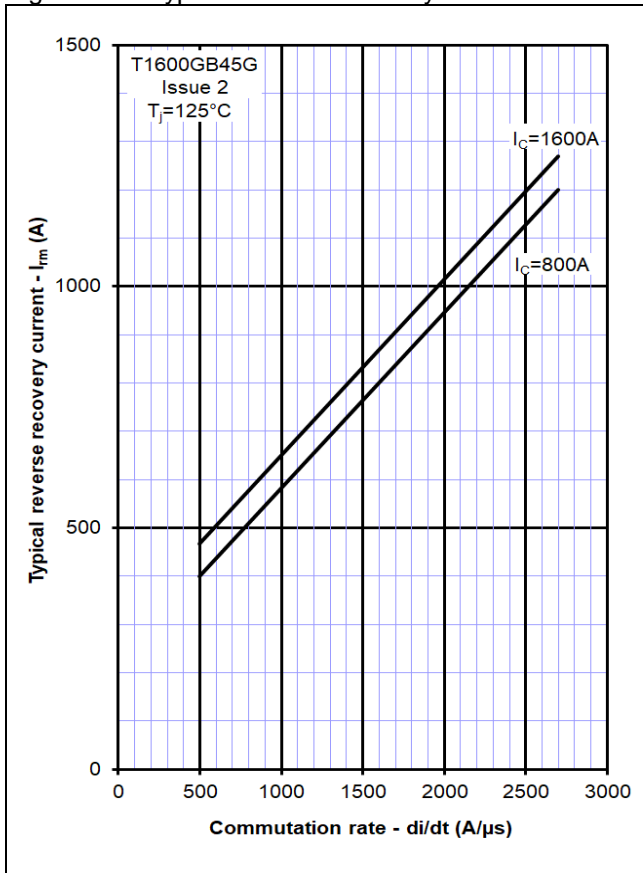

Figure 14 – Typical reverse recovery time

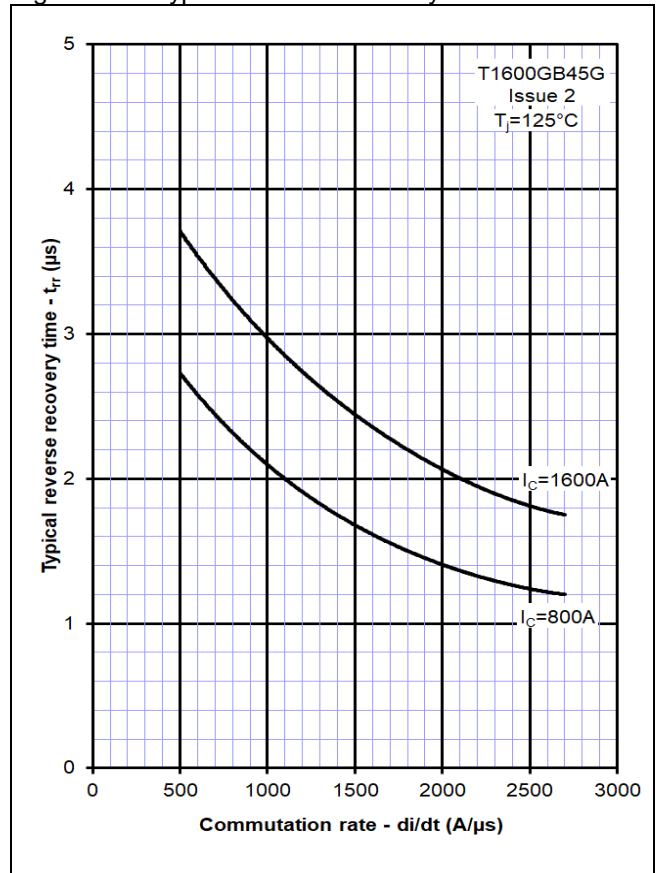

Figure 15 – Typical reverse recovery energy

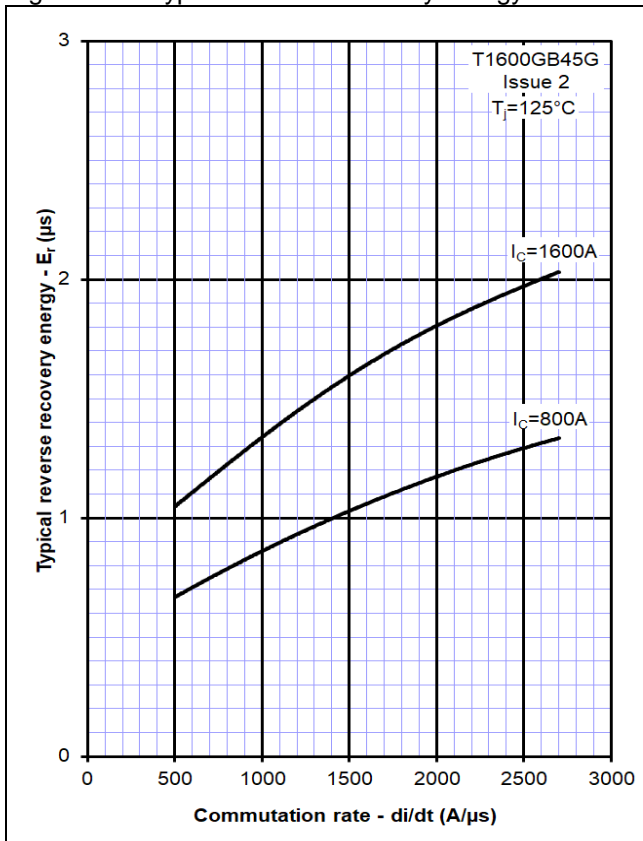

Figure 16 – Safe operating area (Diode)

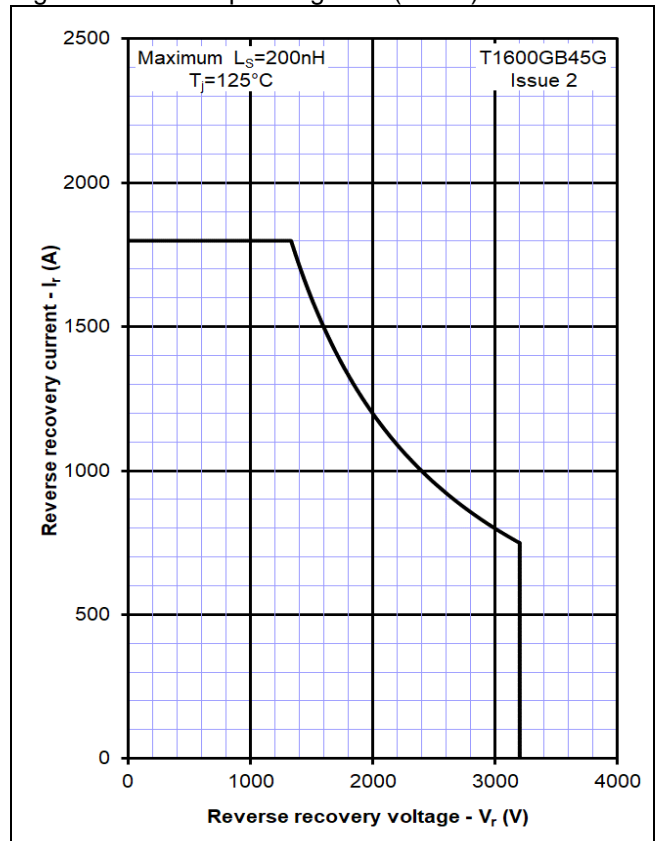

Figure 17 – Transient thermal impedance (IGBT)

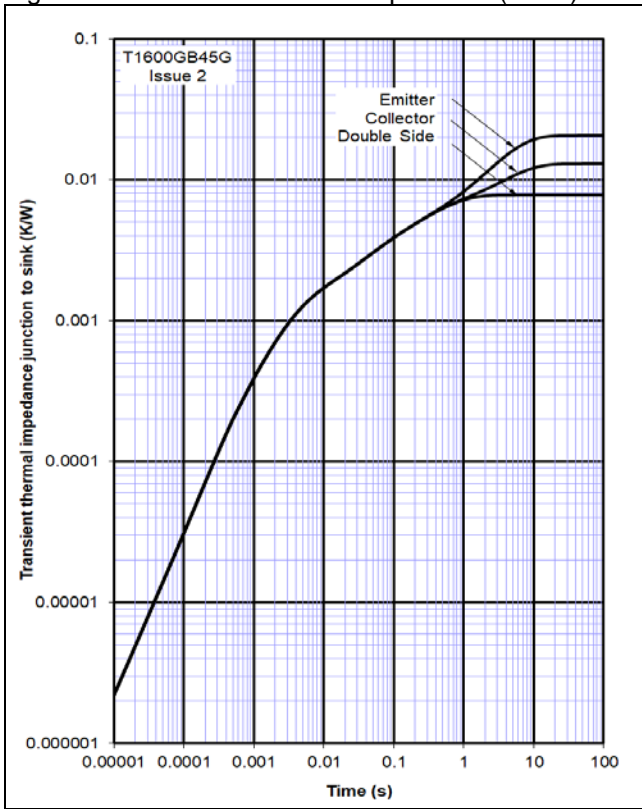
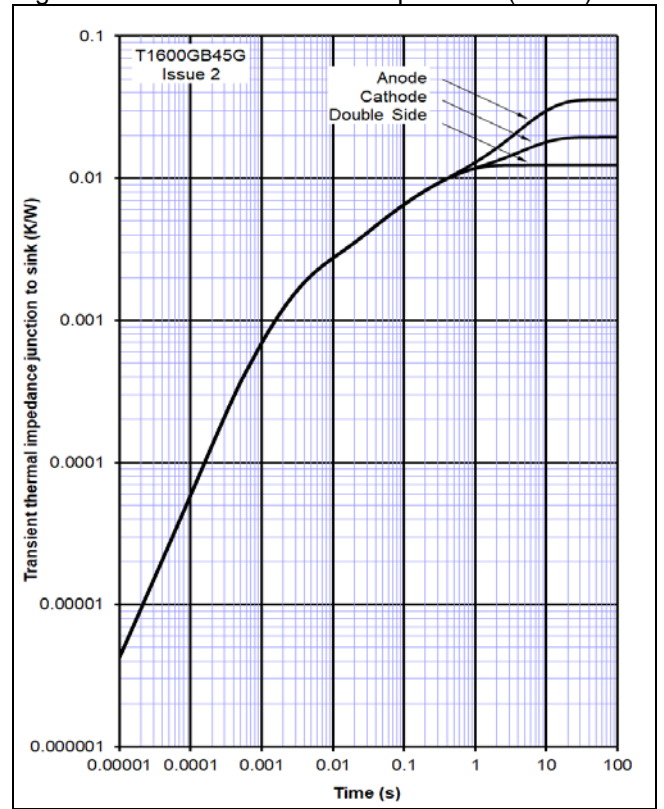
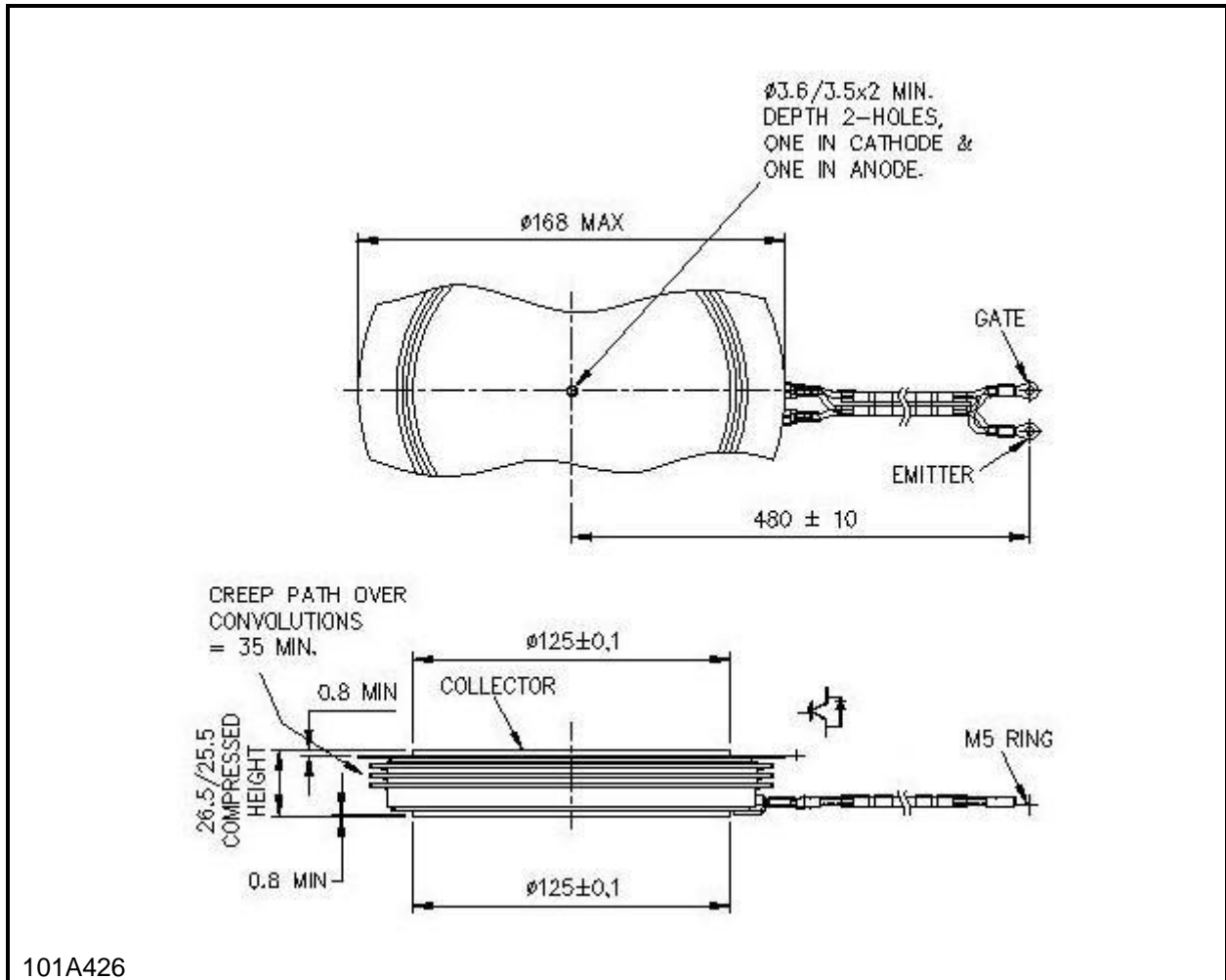

Figure 18 – Transient thermal impedance (Diode)



Outline Drawing & Ordering Information



ORDERING INFORMATION

(Please quote 10 digit code as below)

T1600	GB	45	G
Fixed type Code	Fixed Outline Code	Voltage Grade $V_{CES}/100$ 45	Fixed format code

 Typical order code: T1600GB45G ($V_{CES} = 4500V$)

IXYS Semiconductor GmbH
 Edisonstraße 15
 D-68623 Lampertheim
 Tel: +49 6206 503-0
 Fax: +49 6206 503-627
 E-mail: marcom@ixys.de



IXYS
 A Littelfuse Technology

IXYS UK Westcode Ltd
 Langley Park Way, Langley Park,
 Chippenham, Wiltshire, SN15 1GE.
 Tel: +44 (0)1249 444524
 E-mail: sales@ixysuk.com

IXYS Corporation
 1590 Buckeye Drive
 Milpitas CA 95035-7418
 Tel: +1 (408) 457 9000
 Fax: +1 (408) 496 0670
 E-mail: sales@ixys.net

www.littelfuse.com

www.ixysuk.com

www.ixys.net

IXYS Long Beach
 IXYS Long Beach, Inc
 2500 Mira Mar Ave, Long Beach
 CA 90815
 Tel: +1 (562) 296 6584
 Fax: +1 (562) 296 6585
 E-mail: service@ixyslongbeach.com

The information contained herein is confidential and is protected by Copyright. The information may not be used or disclosed except with the written permission of and in the manner permitted by the proprietors IXYS UK Westcode Ltd.

© IXYS UK Westcode Ltd.

In the interest of product improvement, IXYS UK Westcode Ltd reserves the right to change specifications at any time without prior notice.

Devices with a suffix code (2-letter, 3-letter or letter/digit/letter combination) added to their generic code are not necessarily subject to the conditions and limits contained in this report.



Disclaimer Notice - Information furnished is believed to be accurate and reliable. However, users should independently evaluate the suitability of and test each product selected for their own applications. Littelfuse products are not designed for, and may not be used in, all applications. Read complete Disclaimer Notice at www.littelfuse.com/disclaimer-electronics.