



## **Product Specifications**

**20" WXGA Color TFT-LCD Module  
Model Name: T200XW01**

**(\*) Preliminary Specifications  
( ) Final Specifications**



## Contents

No	ITEM
	COVER
	CONTENTS
	RECORD OF REVISIONS
1	GENERAL DESCRIPTION
2	ABSOLUTE MAXIMUM RATINGS
3	ELECTRICAL SPECIFICATIONS
3-1	ELECTRICAL CHARACTERISTICS
3-2	INTERFACE CONNECTIONS
3-3	SIGNAL TIMING SPECIFICATIONS
3-4	SIGNAL TIMING WAVEFORMS
3-5	COLOR INPUT DATA REFERENCE
3-6	POWER SEQUENCE
4	OPTICAL SPECIFICATIONS
5	MECHANICAL CHARACTERISTICS
6	INTERNATIONAL STANDARDS
6-1	SAFETY
6-2	EMC
7	PACKING
8	PRECAUTIONS



## Record of Revision

Version	Date	No	Old Description	New Description	Remark
0.1	2004/08/10				
0.2	2005/03/02		Update spec		
0.3	2005/5/18		Upgrade response time to 8ms(GTG)		



## 1. General Description

This specification applies to the 20 inch Color TFT-LCD Module T200XW01. This LCD module has a TFT active matrix type liquid crystal panel 1366x768 pixels, and diagonal size of 20 inch. This module supports 1366x768 WXGA mode (Non-interlace).

Each pixel is divided into Red, Green and Blue sub-pixels or dots which are arranged in vertical stripes. Gray scale or the brightness of the sub-pixel color is determined with a 8-bit gray scale signal for each dot.

The T200XW01 has been designed to apply the 8-bit 1 channel LVDS interface method. It is intended to support displays where high brightness, wide viewing angle, high color saturation, and high color depth are very important.

### \* General Information

Items	Specification	Unit	Note
Active Screen Size	20.04	inches	
Display Area	443.61(H) x 249.41(V)	mm	
Outline Dimension	479.0(H) x 278.4(V) x 31.8(D)	mm	
Driver Element	a-Si TFT active matrix		
Display Colors	16.7M	Colors	
Number of Pixels	1366 x 768	Pixel	
Pixel Arrangement	RGB vertical stripe		
Display Mode	Normally Black		
Surface Treatment	HC, 3H		



## 2. Absolute Maximum Ratings

The following are maximum values which, if exceeded, may cause faulty operation or damage to the unit.

Item	Symbol	Min	Max	Unit	Note
Logic/LCD Drive Voltage	V <sub>dd</sub>	-0.3	6	[Volt]	1
Input Voltage of Signal	V <sub>in</sub>	-0.3	(3.6)	[Volt]	1
Operating Temperature	T <sub>OP</sub>	0	+50	[°C]	2
Operating Humidity	H <sub>OP</sub>	10	90	[%RH]	2
Storage Temperature	T <sub>ST</sub>	-20	+60	[°C]	2
Storage Humidity	H <sub>ST</sub>	10	90	[%RH]	2

Note 1 : Duration = 50msec

Note 2 : Maximum Wet-Bulb should be 39°C and No condensation.

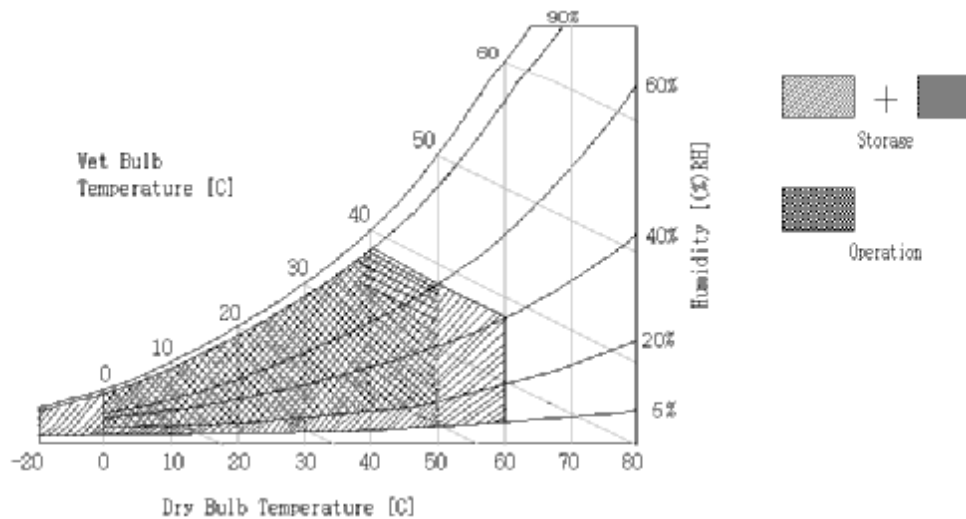



### 3. Electrical Specification

The T200XW01 requires two power inputs. One is employed to power the LCD electronics and to drive the TFT array and liquid crystal. The second input which powers the CCFL, is typically generated by an inverter.

#### 3-1 Electrical Characteristics

Parameter	Symbol	Values			Unit	Notes
		Min	Typ	Max		
LCD:						
Power Supply Input Voltage	Vdd	4.5	5.0	5.5	Vdc	
Power Supply Input Current	Idd	-	0.71	0.95	A	1
Power Consumption	Pc	-	3.6	4.8	Watt	1
Inrush Current	I <sub>RUSH</sub>	-	-	2.4	A	1
Backlight Power Consumption		-	47	-	Watt	2
Life Time		50000	60000		Hours	3

The performance of the Lamp in LCM, for example life time or brightness, is extremely influenced by the characteristics of the DC-AC Inverter. So all the parameters of an inverter should be carefully designed so as not to produce too much leakage current from high-voltage output of the inverter. When you design or order the inverter, please make sure unwanted lighting caused by the mismatch of the lamp and the inverter (no lighting, flicker, etc) never occurs. When you confirm it, the LCD Assembly should be operated in the same condition as installed in your instrument.

Do not attach a conducting tape to lamp connecting wire. If the lamp wire attach to conducting tape, TFT-LCD Module have a low luminance and the inverter has abnormal action because leakage current occurs between lamp wire and conducting tape.

The relative humidity must not exceed 80% non-condensing at temperatures of 40°C or less. At temperatures greater than 40°C, the wet bulb temperature must not exceed 39°C. When operate at low temperatures, the brightness of CCFL will drop and the lifetime of CCFL will be reduced.

**Note :**

1. Vdd=5.0V, fv=75Hz, fCLK=86 Mhz , 25°C, Vdd Duration time= 470 ms

The Power supply input check patent definition and dissipation reference as below :



Horizontal 2 Dot pattern : 0.95A(Max.)

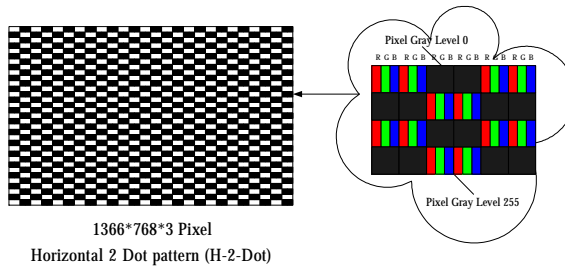

White pattern : 0.79A

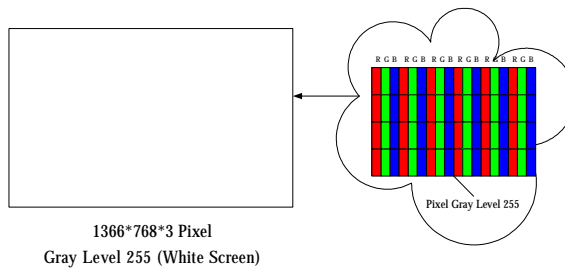

Black pattern : 0.63A

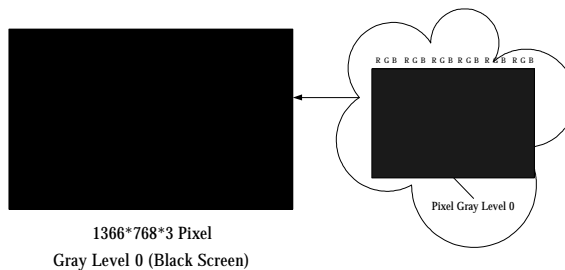

Vertical gray scale pattern : 0.71A(Typ.)

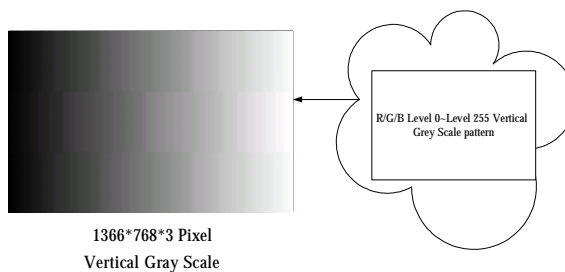

2. The lamp power consumption shown above does include loss of external inverter at 25°C. The used lamp current is the lamp typical current
3. The life is determined as the time at which luminance of the lamp is 50% compared to that of initial value at the typical lamp current on condition of continuous operating at 25±2°C. The lamp current should fix in 4.5mA(typ.) and then keep the 60000hr(typ.) lamp life



### 3-2 Interface Connections

- LCD connector (CN1): JAE FI-X30SSL-HF or equivalent
- LVDS Transmitter: SN75LVDS83(Texas Instruments) or equivalent

**Note:**

1. All GND (ground) pins should be connected together and should also be connected to the LCD's metal frame. All Vcc (power input) pins should be connected together.

No	Description	No	Description
1	N.C.	16	GND
2	N.C.	17	Rx3-
3	N.C.	18	Rx3+
4	GND	19	GND
5	Rx0-	20	N.C.
6	Rx0+	21	LVDS Option*
7	GND	22	N.C.
8	Rx1-	23	GND
9	Rx1+	24	GND
10	GND	25	GND
11	Rx2-	26	Vdd (+5V)
12	Rx2+	27	Vdd (+5V)
13	GND	28	Vdd (+5V)
14	RxCLK-	29	Vdd (+5V)
15	RxCLK+	30	Vdd (+5V)

LVDS Option : H (3.3V) or NC ð NS (Default)

L (GND) ð JETDA





## Backlight Connector Pin Configuration

### Electrical specification (Lamp spec)

Parameter	Min	Typ	Max	Units	Condition
CCFL current(ICFL)	4.0	4.5	6.0	[mA] rms	(Ta=25°C)
CCFL Frequency(FCFL)	40	62	80	[KHz]	(Ta=25°C)
CCFL Ignition Voltage(Vs)	1570	-	-	[Volt] rms	(Ta= 0°C)
CCFL Voltage (Reference) (VCFL)	-	790	860	[Volt] rms	(Ta=25°C)
CCFL Power consumption (PCFL)	-	47	-	[Watt]	(Ta=25°C)

### Lamp connect configuration (recommend)

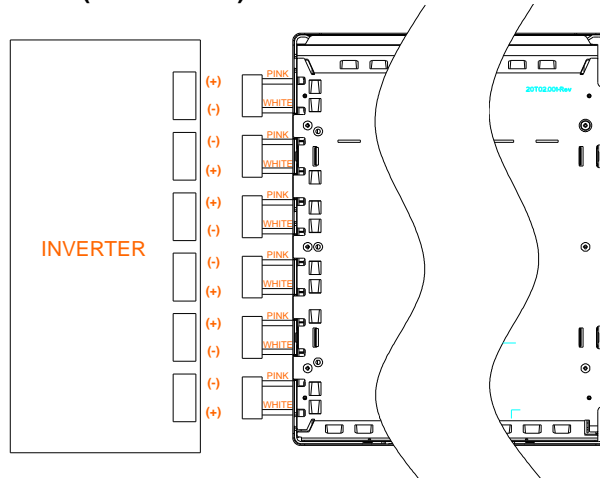

### Module Block Diagram

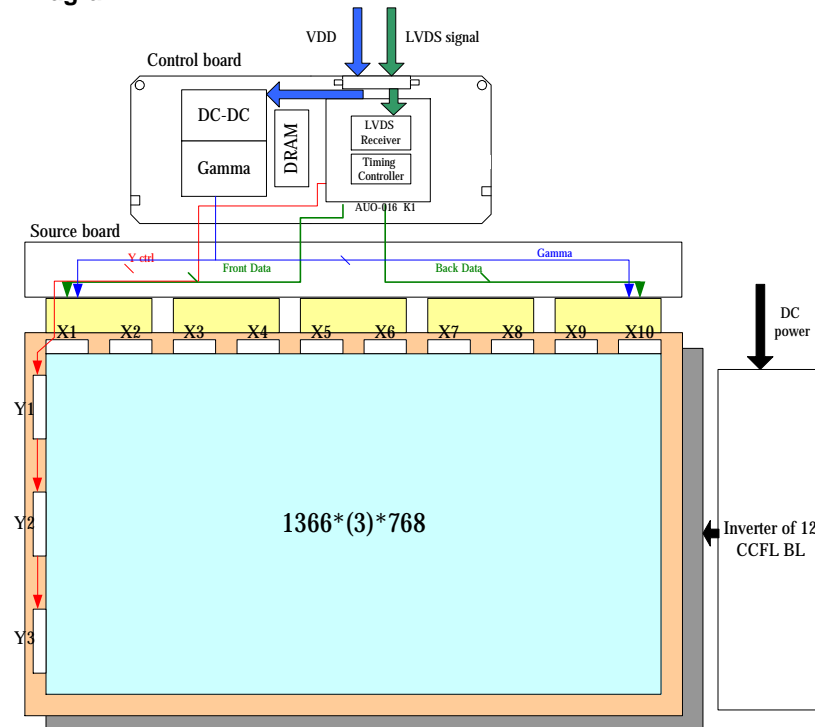



### 3-3 Signal Timing Specifications

This is the signal timing required at the input of the User connector. All of the interface signal timing should be satisfied with the following specifications for its proper operation.

\* Timing Table

Item	Symbol	Min.	Typ.	Max.	Unit	
<b>DCLK</b>	<b>Period</b>	Tc	11.6	12.3	15.3	ns
	<b>Freq.</b>	fc	54	81	86	MHz
<b>Hsync</b>	<b>Freq.</b>	1/Th	-	-	-	KHz
<b>Vsync</b>	<b>Freq.</b>	1/Yv	50	60	75	Hz
<b>Vertical</b>	<b>Period</b>	Tv	776	840	1024	Th
	<b>Active</b>	Tvd	---	768	---	Th
<b>Horizontal</b>	<b>Period</b>	Th	1406	1606	2048	DCLK
	<b>Active</b>	Thd	---	1366	---	DCLK

\*1) DCLK signal input must be valid while power supply is applied.

\*2) Display position is specific by the rise of ENAB signal only.

Horizontal display position is specified by the falling edge of 1<sup>st</sup> DCLK right after the rise of ENAB, is displayed on the left edge of the screen.

Vertical display position is specified by the rise of ENAB after a "Low" level period equivalent to eight times of horizontal period. The 1<sup>st</sup> data corresponding to one horizontal line after the rise the of ENAB is displayed at the top line of screen.

3.) If a period of ENAB "High" is less than 1366 DCLK or less than 768 lines, the rest of the screen displays black.

4.) The display position does not fit to the screen if a period of ENAB "High" and the effective data period do not synchronize with each other.



### 3-4 Signal Timing Waveforms

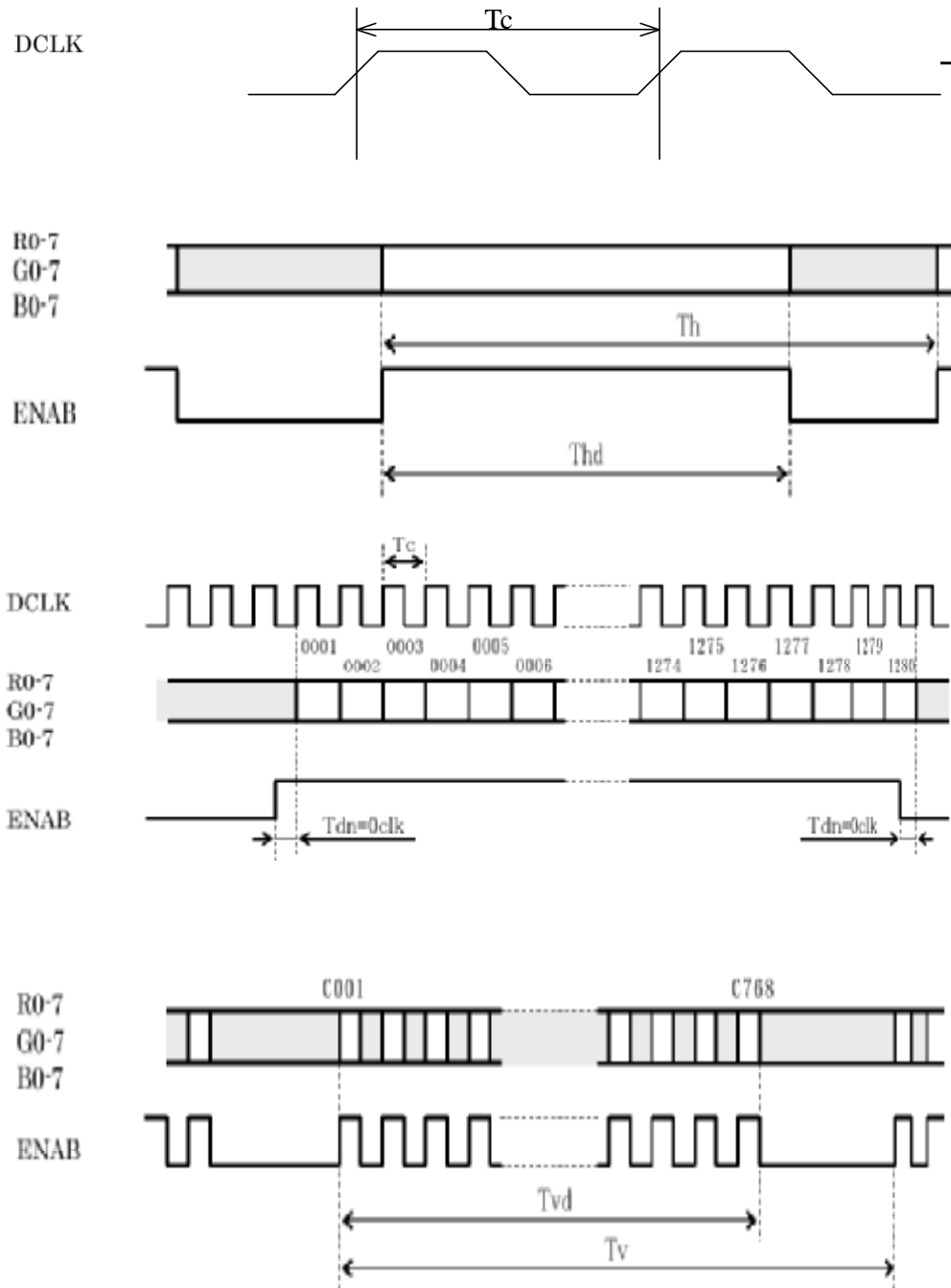



### 3-5 Color Input Data Reference

The brightness of each primary color (red, green and blue) is based on the 8 bit gray scale data input for the color; the higher the binary input, the brighter the color. The table below provides a reference for color versus data input.

#### COLOR DATA REFERENCE

Color		Input Color Data																							
		RED								GREEN								BLUE							
		MSB				LSB				MSB				LSB				MSB				LSB			
		R7	R6	R5	R4	R3	R2	R1	R0	G7	G6	G5	G4	G3	G2	G1	G0	B7	B6	B5	B4	B3	B2	B1	B0
Basic Color	Black	0	0	0	0	0	0	0	0	0	0	0	0	0	0	0	0	0	0	0	0	0	0	0	
	Red(255)	1	1	1	1	1	1	1	1	0	0	0	0	0	0	0	0	0	0	0	0	0	0	0	
	Green(255)	0	0	0	0	0	0	0	0	1	1	1	1	1	1	1	1	0	0	0	0	0	0	0	
	Blue(255)	0	0	0	0	0	0	0	0	0	0	0	0	0	0	0	0	1	1	1	1	1	1	1	
	Cyan	0	0	0	0	0	0	0	0	1	1	1	1	1	1	1	1	1	1	1	1	1	1	1	
	Magenta	1	1	1	1	1	1	1	1	0	0	0	0	0	0	0	0	1	1	1	1	1	1	1	
	Yellow	1	1	1	1	1	1	1	1	1	1	1	1	1	1	1	1	0	0	0	0	0	0	0	
	White	1	1	1	1	1	1	1	1	1	1	1	1	1	1	1	1	1	1	1	1	1	1	1	
RED	RED(000)	0	0	0	0	0	0	0	0	0	0	0	0	0	0	0	0	0	0	0	0	0	0		
	RED(001)	0	0	0	0	0	0	0	1	0	0	0	0	0	0	0	0	0	0	0	0	0	0		
	----																								
	RED(254)	1	1	1	1	1	1	1	0	0	0	0	0	0	0	0	0	0	0	0	0	0	0		
	RED(255)	1	1	1	1	1	1	1	1	0	0	0	0	0	0	0	0	0	0	0	0	0	0		
GREEN	GREEN(000)	0	0	0	0	0	0	0	0	0	0	0	0	0	0	0	0	0	0	0	0	0	0		
	GREEN(001)	0	0	0	0	0	0	0	0	0	0	0	0	0	0	1	0	0	0	0	0	0	0		
	----																								
	GREEN(254)	0	0	0	0	0	0	0	0	1	1	1	1	1	1	1	0	0	0	0	0	0	0		
	GREEN(255)	0	0	0	0	0	0	0	0	1	1	1	1	1	1	1	0	0	0	0	0	0	0		
BLUE	BLUE(000)	0	0	0	0	0	0	0	0	0	0	0	0	0	0	0	0	0	0	0	0	0	0		
	BLUE(001)	0	0	0	0	0	0	0	0	0	0	0	0	0	0	0	0	0	0	0	0	0	1		
	-----																								
	BLUE(254)	0	0	0	0	0	0	0	0	0	0	0	0	0	0	0	1	1	1	1	1	1	1	0	
	BLUE(255)	0	0	0	0	0	0	0	0	0	0	0	0	0	0	0	1	1	1	1	1	1	1	1	



### 3-6 Power Sequence

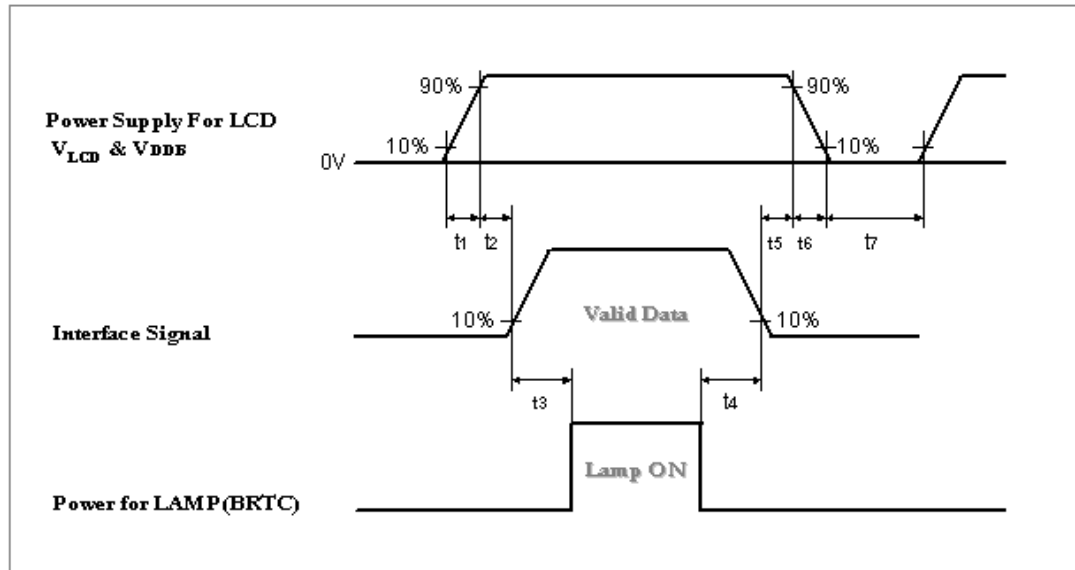

Parameter	Values			Units
	Min.	Typ.	Max.	
t1	470	-	1000	us
t2	25	-	150	ms
t3	650	-	-	ms
t4	200	-	-	ms
t5	50	-	-	ms
t6	0.47	-	30	ms
t7	1	-	-	s

Apply the lamp voltage within the LCD operating range. When the backlight turns on before the LCD operation or the LCD turns off before the backlight turns off, the display may momentarily become abnormal.

**Caution :** The above on/off sequence should be applied to avoid abnormal function in the display. In case of handling, make sure to turn off the power when you plug the cable into the input connector or pull the cable out of the connector.



### 4. Optical Specification

Optical characteristics are determined after the unit has been 'ON' and stable for approximately 30 minutes in a dark environment at 25°C. The values specified are at an approximate distance 50cm from the LCD surface at a viewing angle of  $\Phi$  and  $\theta$  equal to 0°.

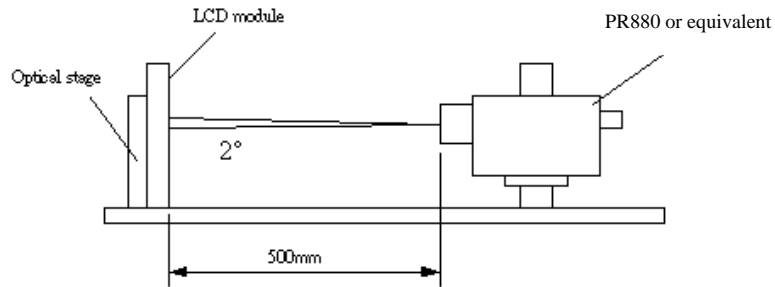

Fig.4-1 Optical measurement equipment and method

Parameter	Symbol	Values			Units	Notes
		Min.	Typ.	Max.		
Contrast Ratio	CR	650	800			1
Surface Luminance, white	LWH	350	450		cd/m <sup>2</sup>	2
Luminance Variation	$\delta_{WHITE}$	5 p		1.25		3
Response Time (Average)	$T_{\gamma}$		8		ms	4,5 (Gray to Gray)
	Rise Time		(15)	(18)	ms	
	Decay Time		(10)	(13)	ms	
Color Coordinates						
	RED	$R_x$		0.643		
		$R_y$		0.329		
	GREEN	$G_x$		0.292		
		$G_y$	Typ.-0.03	0.587	Typ.+0.03	
	BLUE	$B_x$		0.138		
		$B_y$		0.074		
	WHITE	$W_x$		0.284		
		$W_y$		0.295		
Viewing Angle						
	x axis, right( $\varphi=0^\circ$ )	$\theta_r$	80	85	Degree	6
	x axis, left( $\varphi=180^\circ$ )	$\theta_l$	80	85		
	y axis, up( $\varphi=90^\circ$ )	$\theta_u$	80	85		
	y axis, down ( $\varphi=0^\circ$ )	$\theta_d$	80	85		



Note:

1. Contrast Ratio (CR) is defined mathematically as:

$$\text{Contrast ratio (CR)} = \frac{\text{Brightness on the "white" state}}{\text{Brightness on the "black" state}}$$

2. Surface luminance is luminance value at point 1 across the LCD surface 50cm from the surface with all pixels displaying white. From more information see FIG 4-2. When  $I_{BL} = 4.5\text{mA}$ ,  $L_{WH} = 450\text{cd/m}^2$  (typ.)  $L_{WH} = L_{on1}$ , Where  $L_{on1}$  is the luminance with all pixels displaying white at center 1 location.

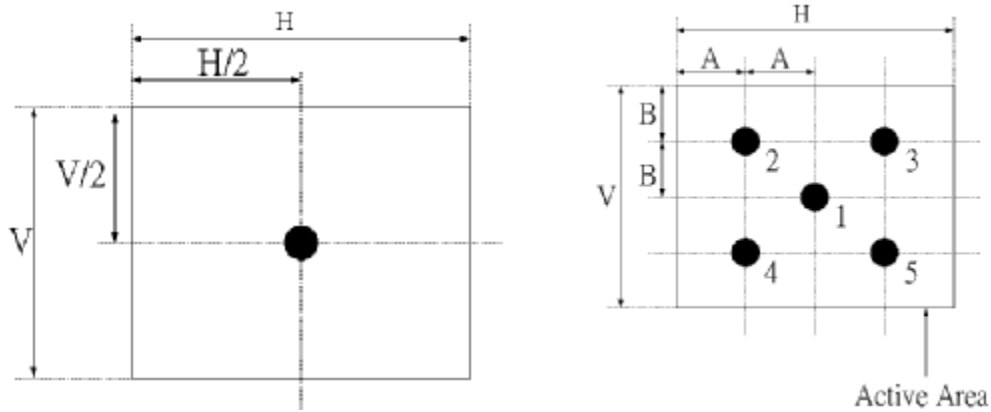

Fig.4-2 Optical measurement point

3. The variation in surface luminance,  $\delta$  WHITE is defined (center of Screen) as:

$$\delta_{\text{WHITE}(5P)} = \frac{\text{Maximum}(L_{on1}, L_{on2}, \dots, L_{on5})}{\text{Minimum}(L_{on1}, L_{on2}, \dots, L_{on5})}$$

4. Response time is the time required for the display to transition from white(L255) to black(L0) (Decay Time,  $T_{rD} = T_f$ ) and from black(L0) to white(L255) (Rise Time,  $T_{rR} = T_r$ ). For additional information see FIG4-3.

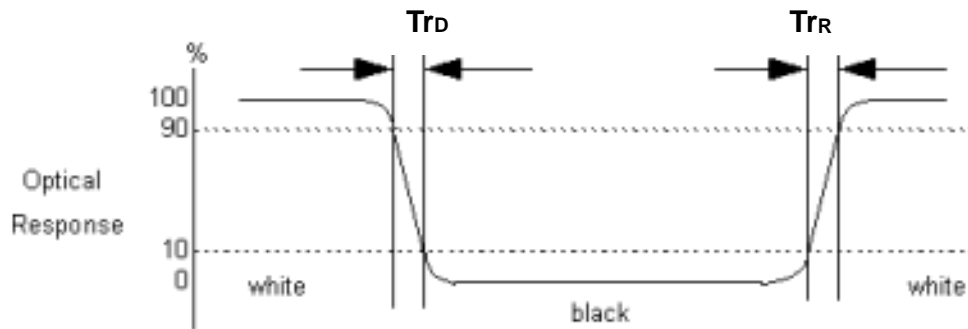

Fig.4-3 Response time



5. The response time is defined as the following figure and shall be measured by switching the input signal for different gray level. For additional information see FIG4-4

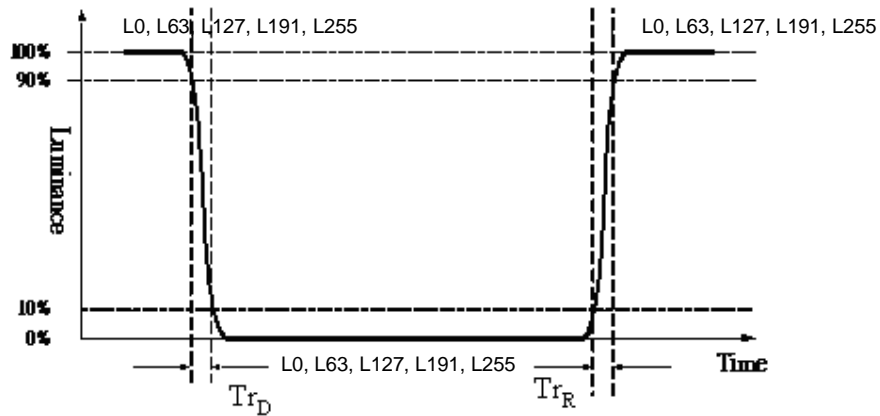

Fig.4-4 Response time

6. Viewing angle is the angle at which the contrast ratio is greater than 10. The angles are determined for the horizontal or x axis and the vertical or y axis with respect to the z axis which is normal to the LCD surface. For more information see FIG4-5.

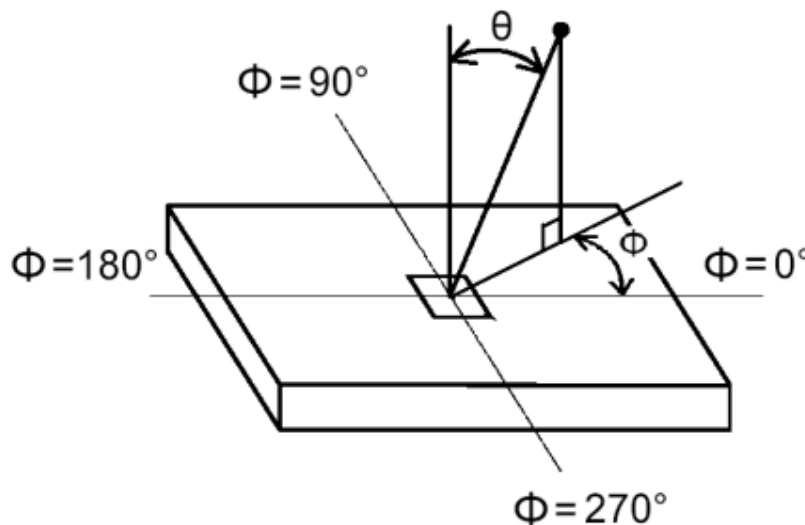

Fig.4-5 Viewing Angle Definition





## 5. Mechanical Characteristics

The contents provide general mechanical characteristics for the model T200XW01. In addition the figures in the next page are detailed mechanical drawing of the LCD.

Outline Dimension	Horizontal (typ.)	479.0mm
	Vertical (typ.)	278.4mm
	Depth (typ.)	31.8mm
Bezel Area	Horizontal (typ.)	447.6mm
	Vertical (typ.)	253.4mm
Active Display Area	Horizontal	443.61mm
	Vertical	249.41mm
Weight	2000g (max.)	
Surface Treatment	HC, 3H	



Front View

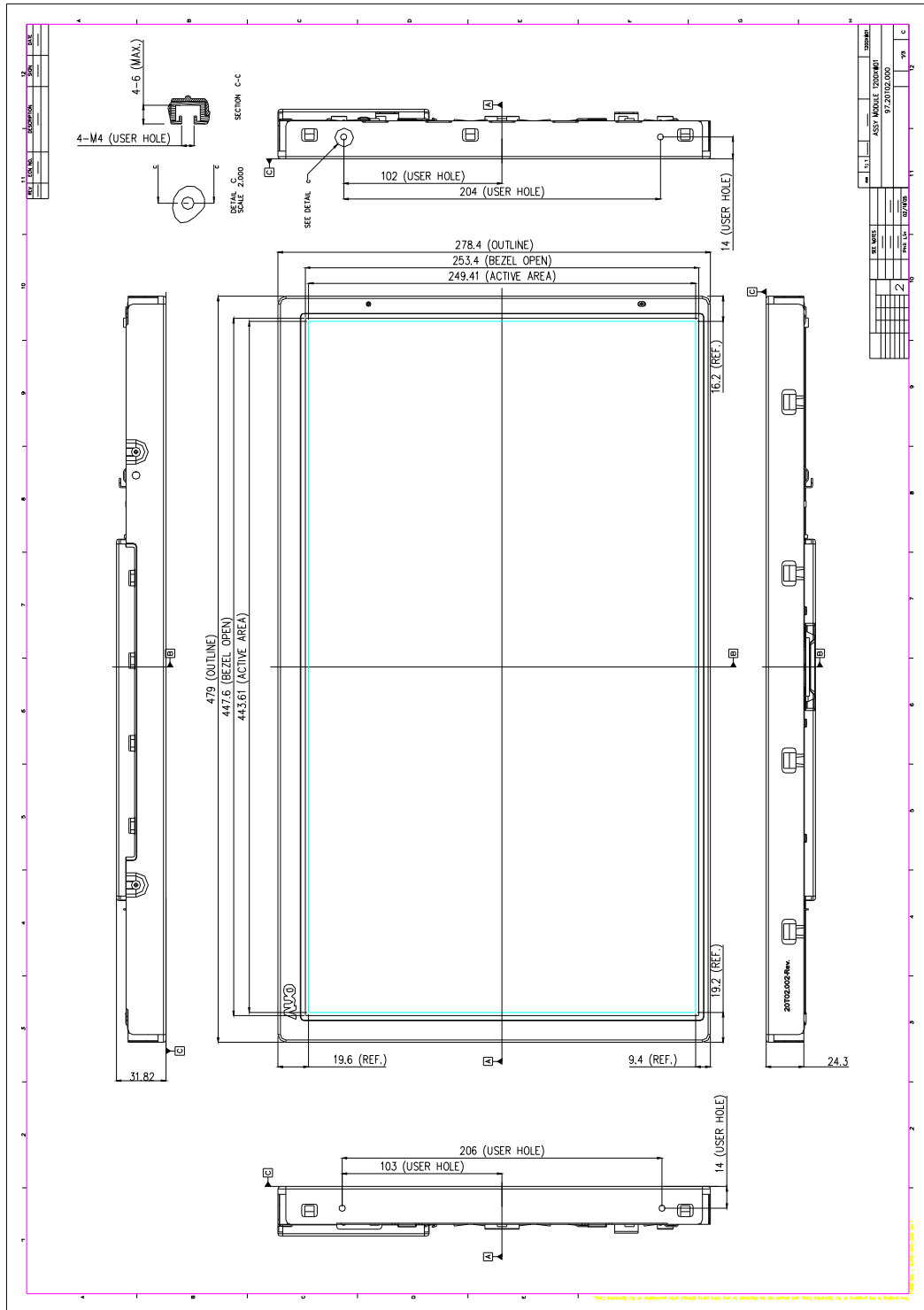

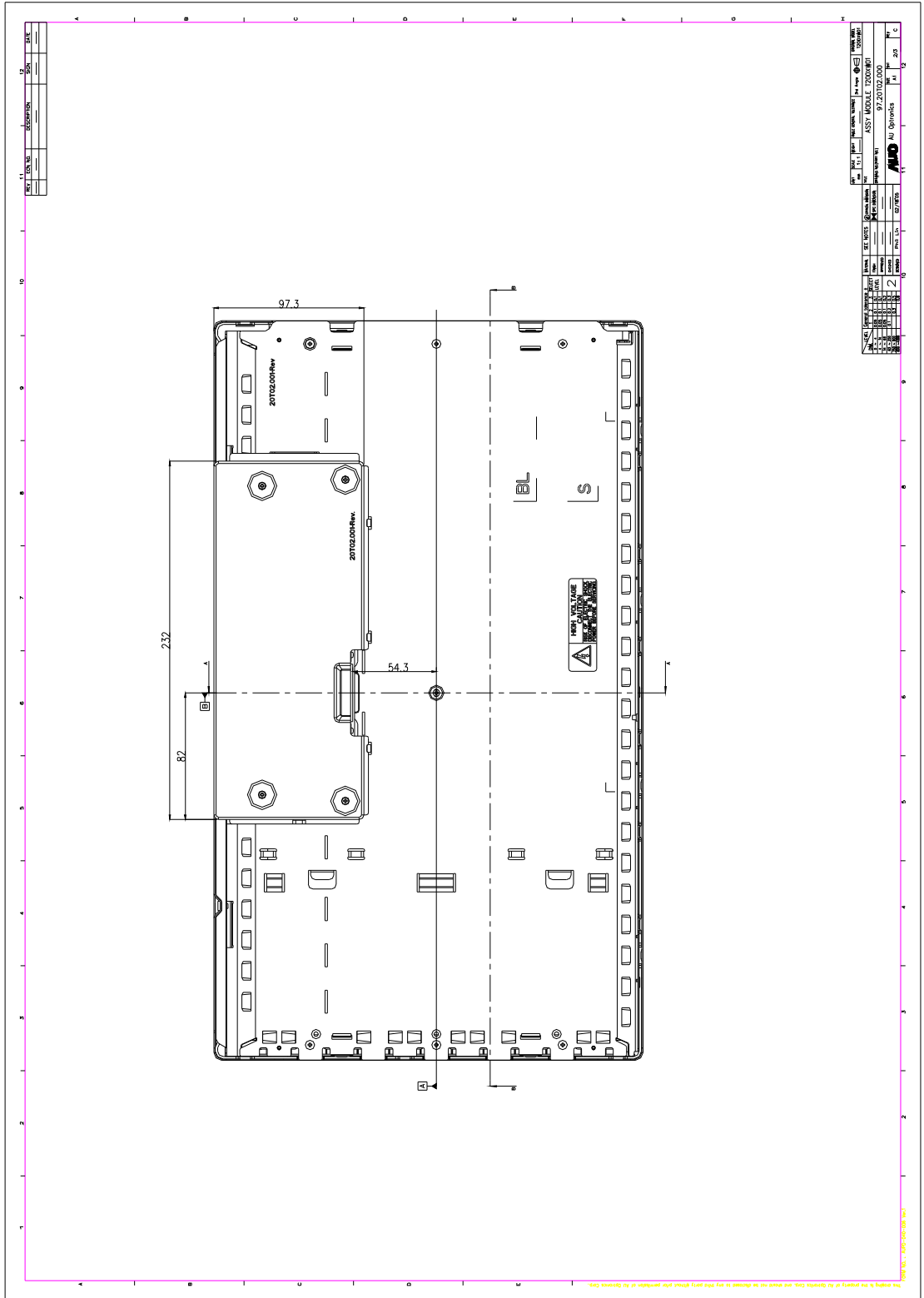



## 6. International Standard

### 6-1. Safety

- (1) UL6500, Underwriters Laboratories, Inc. (AUO file number : E204356)  
Standard for Safety of Information Technology Equipment Including electrical Business Equipment.
- (2) CAN/CSA C22.2 No. 950-95 Third Edition, Canadian Standards Association, Jan. 28, 1995  
Standard for Safety of Information Technology Equipment Including Electrical Business Equipment.
- (3) EN60950 : 1992+A2: 1993+A2: 1993+C3: 1995+A4: 1997+A11: 1997  
IEC 950: 1991+A1: 1992+A2: 1993+C3: 1995+A4:1996  
IEC 60065  
European Committee for Electro technical Standardization (CENELEC)  
EUROPEAN STANDARD for Safety of Information Technology Equipment Including Electrical Business Equipment.

### 6-2. EMC

- a) ANSI C63.4 "Methods of Measurement of Radio-Noise Emissions from Low-Voltage Electrical and Electrical Equipment in the Range of 9kHz to 40GHz. "American National standards Institute(ANSI), 1992
- b) C.I.S.P.R "Limits and Methods of Measurement of Radio Interface Characteristics of Information Technology Equipment." International Special committee on Radio Interference.
- c) EN 55022 "Limits and Methods of Measurement of Radio Interface Characteristics of Information Technology Equipment." European Committee for Electrotechnical Standardization. (CENELEC), 1998



## 7. Packing

### Label Sample



### Carton Label

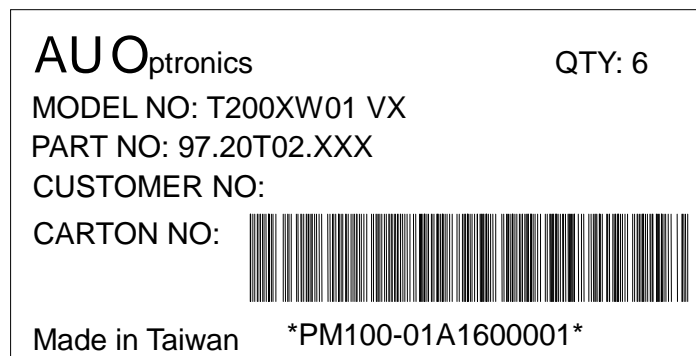

Cushion set

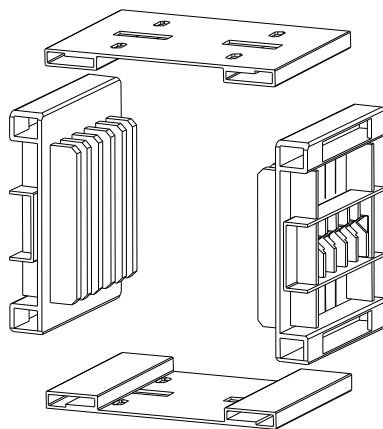

Carton Box, 320mm(W)x590mm(L)x410mm(H)





**Pallet Package**

Air Cargo : (3 \*2) \*3 layers, total 18 boxes with 108 pcs panel in one pallet

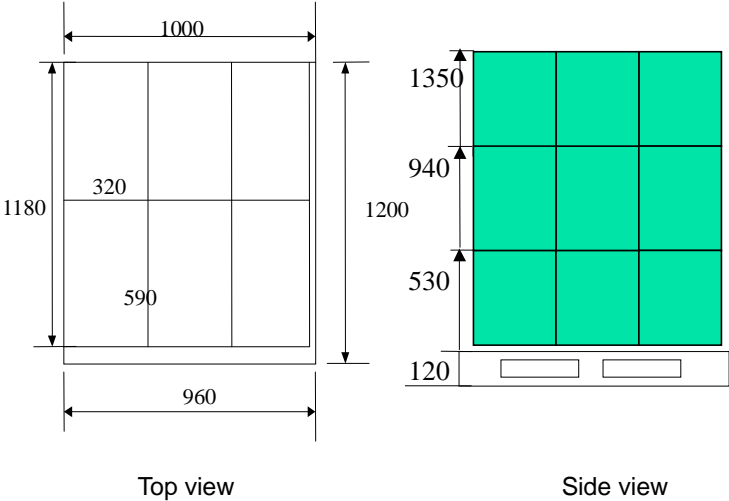

Ocean shipping : (3 \*2) \*5layers, total 30 boxes with 180 pcs panel in one pallet

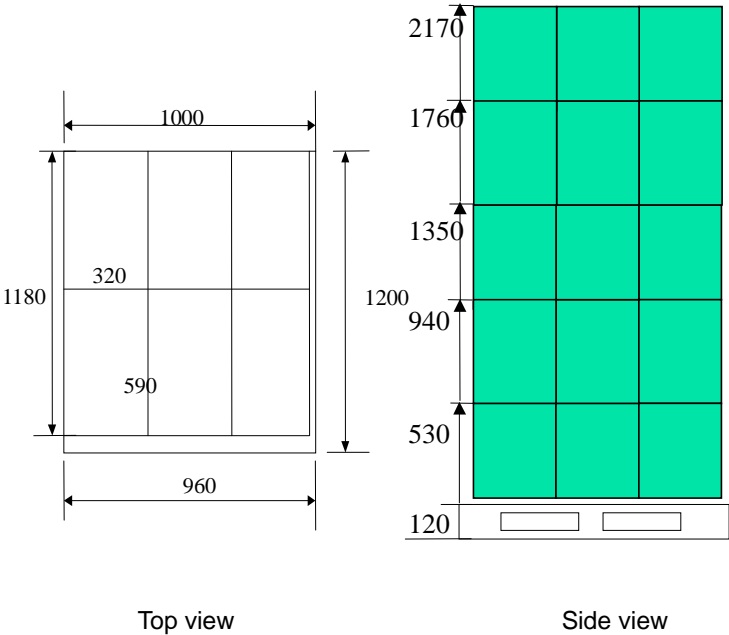



## 8. PRECAUTIONS

Please pay attention to the followings when you use this TFT LCD module.

### 8-1 MOUNTING PRECAUTIONS

- (1) You must mount a module using holes arranged in four corners or four sides.
- (2) You should consider the mounting structure so that uneven force (ex. Twisted stress) is not applied to module. And the case on which a module is mounted should have sufficient strength so that external force is not transmitted directly to the module.
- (3) Please attach the surface transparent protective plate to the surface in order to protect the polarizer. Transparent protective plate should have sufficient strength in order to resist external force.
- (4) You should adopt radiation structure to satisfy the temperature specification.
- (5) Acetic acid type and chlorine type materials for the cover case are not desirable because the former generates corrosive gas of attacking the polarizer at high temperature and the latter causes circuit break by electro-chemical reaction.
- (6) Do not touch, push or rub the exposed polarizers with glass, tweezers or anything harder than HB pencil lead. And please do not rub with dust clothes with chemical treatment. Do not touch the surface of polarizer for bare hand or greasy cloth. (Some cosmetics are detrimental to the polarizer.)
- (7) When the surface becomes dusty, please wipe gently with absorbent cotton or other soft materials like chamois soaks with petroleum benzene. Normal-hexane is recommended for cleaning the adhesives used to attach front/ rear polarizers. Do not use acetone, toluene and alcohol because they cause chemical damage to the polarizer.
- (8) Wipe off saliva or water drops as soon as possible. Their long time contact with polarizer causes deformations and color fading.
- (9) Do not open the case because inside circuits do not have sufficient strength.

### 8-2 OPERATING PRECAUTIONS

- (1) The spike noise causes the mis-operation of circuits. It should be lower than following voltage:  $V = \pm 200\text{mV}$  (Over and under shoot voltage)
- (2) Response time depends on the temperature. (In lower temperature, it becomes longer..)
- (3) Brightness depends on the temperature. (In lower temperature, it becomes lower.) And in lower temperature, response time (required time that brightness is stable after turned on) becomes longer.



- (4) Be careful for condensation at sudden temperature change. Condensation makes damage to polarizer or electrical contacted parts. And after fading condensation, smear or spot will occur.
- (5) When fixed patterns are displayed for a long time, remnant image is likely to occur.
- (6) Module has high frequency circuits. Sufficient suppression to the electromagnetic interference shall be done by system manufacturers. Grounding and shielding methods may be important to minimize the interface.

### **8-3 ELECTROSTATIC DISCHARGE CONTROL**

Since a module is composed of electronic circuits, it is not strong to electrostatic discharge. Make certain that treatment persons are connected to ground through wrist band etc. And don't touch interface pin directly.

### **8-4 PRECAUTIONS FOR STRONG LIGHT EXPOSURE**

Strong light exposure causes degradation of polarizer and color filter.

### **8-5 STORAGE**

When storing modules as spares for a long time, the following precautions are necessary.

- (1) Store them in a dark place. Do not expose the module to sunlight or fluorescent light. Keep the temperature between 5°C and 35°C at normal humidity.
- (2) The polarizer surface should not come in contact with any other object. It is recommended that they be stored in the container in which they were shipped.

### **8-6 HANDLING PRECAUTIONS FOR PROTECTION FILM**

- (1) The protection film is attached to the bezel with a small masking tape. When the protection film is peeled off, static electricity is generated between the film and polarizer. This should be peeled off slowly and carefully by people who are electrically grounded and with well ion-blown equipment or in such a condition, etc.
- (2) When the module with protection film attached is stored for a long time, sometimes there remains a very small amount of glue still on the Bezel after the protection film is peeled off.
- (3) You can remove the glue easily. When the glue remains on the Bezel or its vestige is recognized, please wipe them off with absorbent cotton waste or other soft material like chamois soaked with normal-hexane.