



Product Description: 20" WXGA Color TFT-LCD Module	
AUO Model Name: T200XW02 V0	
Customer Part No/Project Name:	
Customer Signature	AUO 2006/03/13
	Approved By: PL Chen <i>PL Chen</i>
	Reviewed By: Hong Jye Hong <i>Hong Jye Hong</i>
	Prepared By: Jerry Lee <i>Jerry Lee</i>

3/21/06

Please return one copy with your signature and comments for our confirmation.

AU Optronics Corporation

Tel: +886-3-563-2899

Fax: +886-3-563-1590

* No Reproduction and Redistribution Allowed



Product Specifications

**20" WXGA Color TFT-LCD Module
Model Name: T200XW02**

**() Preliminary Specifications
(*) Final Specifications**



Contents

No	ITEM
	COVER
	CONTENTS
	RECORD OF REVISIONS
1	GENERAL DESCRIPTION
2	ABSOLUTE MAXIMUM RATINGS
3	ELECTRICAL SPECIFICATIONS
3-1	ELECTRICAL CHARACTERISTICS
3-2	INTERFACE CONNECTIONS
3-3	SIGNAL TIMING SPECIFICATIONS
3-4	SIGNAL TIMING WAVEFORMS
3-5	COLOR INPUT DATA REFERENCE
3-6	POWER SEQUENCE
4	OPTICAL SPECIFICATIONS
5	MECHANICAL CHARACTERISTICS
6	INTERNATIONAL STANDARDS
6-1	SAFETY
6-2	EMC
7	PACKING (Green Mark Description)
8	PRECAUTIONS



Record of Revision

Version	Date	No	Old Description	New Description	Remark
0.1	2005/11/14	1		First Draft	
0.2	2005/12/06	1	Lack of Electronic spec	Update Electronic Spec	
		2		Update 2D Drawing	
0.3	2006/01/26	3-1	Electrical Characteristics	Add the data of electronic items.	
		3-2	Interface Connections	Update the new format and more detail information.	
		3-2	Backlight electrical specification	Add the data of electronic items.	
0.4	2006/02/20	1	Contrast Ratio: 600:1(typ.)	Contrast Ratio: 700:1(typ.)	
		1	Power Consumption = 40.7W	Power Consumption = 44.4W	
		3-1	Inrush current= 2A typ.	Inrush current= 2A max.	
		3-1	Only consider the power consumption of BLU only.	Update the power consumption and include the loss of inverter.	
		3-2	Backlight electrical specification	Update the ignition voltage under Ta= 25°C and 0°C.	
				Update VCFL and PCFL	
		3-3	Signal Timing Specification	Update Timing Table	
		3-6	Power Sequence	Update	
		4	Optical Specification	Update and add Color Information.	
		4	Viewing Angle	Add the meter as <u>ELDIM EZ Contrast 160D.</u>	
		5	Mechanical Characteristics	Update the max of depth value as 24mm.	
		5	2D drawing Rear View	Lamp Cable change form 90mm to 130mm typ.	
0.5	2006/03/06	3-2	Backlight Connector Pin Configuration	To add the description of lamp's cable color	
0.6	2006/03/07	3-2	Backlight Electrical specification (Lamp spec)	CCFL Frequency: Min:40 Typ.:55 Max:70 (KHz)	
0.7	2006/03/13	1	Viewing Angle (L/R/U/D)	80/80/80/60 → 80/80/70/70	
		3-1	Electrical Characteristics	To add the max. value of power consumption	
		3-2	Backlight Electrical specification (Lamp spec)	CCFL current (ICFL): Min: 5.0 (mA) CCFL voltage (VCFL): 823~894 (Volt)	
		3-3	Signal Timing Specification	Combine Vertical Frequency Range A and B.	
		3-6	Power Sequence	t1's max value change from 1 to 20 ms	
		4	Optical Specification	Response Time: To add the value and the note 4.	
		4	Optical Specification	Viewing Angle: 80/80/ 70/70	



1. General Description

This specification applies to the 20.0 inch Color TFT-LCD Module T200XW02.

This module supports the WXGA (1366(H) x 768(V)) screen format and 16.2M colors (6-bits + FRC).

All input signals are 1 channel LVDS interface compatible.

This module is without any inverter card for backlight.

Features

- WXGA 1366(H) x 768(V) resolution
- Fast response Time (8ms)
- 50,000 hours lamp life
- 6 CCFL Side Light Design (Cold Cathode Fluorescent Lamp)
- High brightness, High contrast ratio
- Wide viewing angle
- Low power consumption
- Green Design (ROHS Compliance)
- HDTV Ready Module

Application

Personal TV

Multi-function media

Video Game Console



* General Information

The following items are characteristics summary on the table 25 °C condition:

Items	Specification	Unit	Note
Active Screen Size	20.04 inches		50.9cm diagonal
Display Area	443.61(H) x 249.41(V)	mm	
Outline Dimension	472.0(H) x 276.5(V) x 23.0(D) (typ.)*	mm	Without inverter
Resolution	1366(R,G,Bx3) x 768	Pixels	
Pixel Pitch	0.32475 x 0.32475		
Pixel Arrangement	RGB vertical stripe		
Display mode	TN mode, Normally White		
Display Colors	16.2M (6-bit + FRC for R,G,B)	Colors	
Typical White Luminance	450 nit (typ.) @ 6.5mA	[cd/m ²]	
Contrast Ratio	700:1(typ.)		
Color Gamut	72%(typ.) of NTSC		
Response Time	8ms(typ.) (Tr+Tf)	ms	
Viewing Angle (L/R/U/D)	80/80/70/70		CR>10
Power Consumption	44.4 W (typ.)(Vdd line +CCFL line)**	W	@6.5mA
Electronic Interface	1ch LVDS		
Frame rate	60Hz(typ.), 75Hz(max.)	Hz	
Weight(g)	3000(max)	g	
Surface Treatment	Hard-Coating 3H, AG		
ROHS	ROHS compliance		

* The depth of module is 23mm typ. and 24mm max.

** To consider the loss of Inverter's efficiency.



2. Absolute Maximum Ratings

The following are maximum values which, if exceeded, may cause faulty operation or damage to the unit.

Item	Symbol	Min	Max	Unit	Note
Logic/LCD Drive Voltage	V _{DD}	-0.3	6	[Volt]	1
Input Voltage of Signal	V _{IN}	-0.3	3.6	[Volt]	1
Operating Temperature	T _{OP}	0	+50	[°C]	2
Operating Humidity	H _{OP}	10	90	[%RH]	2
Storage Temperature	T _{ST}	-20	+60	[°C]	2
Storage Humidity	H _{ST}	10	90	[%RH]	2

Note 1 : Duration = 50msec

Note 2 : Maximum Wet-Bulb should be 39°C and No condensation.

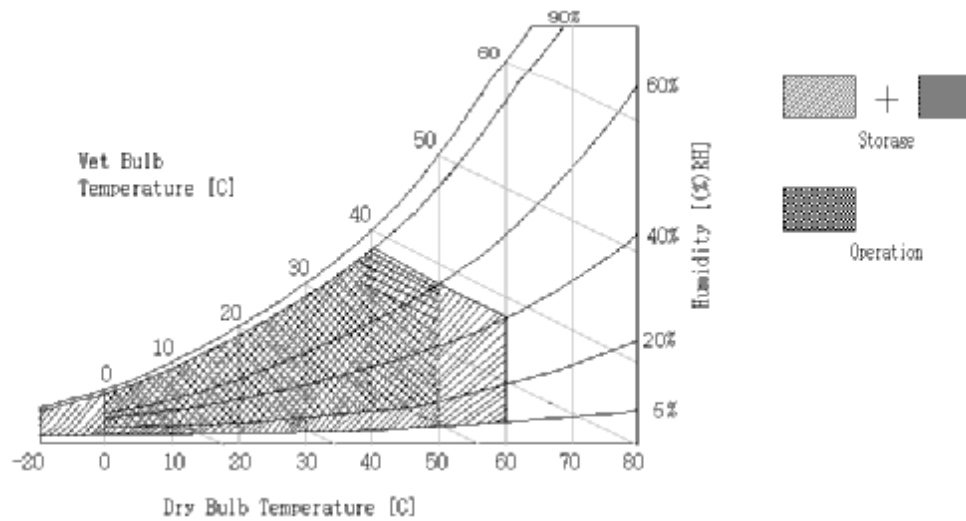



3. Electrical Specification

The T200XW02 requires two power inputs. One is employed to power the LCD electronics and to drive the TFT array and liquid crystal. An inverter typically generates the second input, which powers the CCFL.

3-1 Electrical Characteristics

Parameter	Symbol	Values			Unit	Notes
		Min	Typ	Max		
LCD:						
Power Supply Input Voltage	Vdd	4.5	5.0	5.5	Vdc	
Power Supply Input Current	I _{dd}	-	0.72	0.9	A	1
Power Consumption	P _c	-	3.6	4.5	Watt	1
Inrush Current	I _{RUSH}	-	-	2.0	A	1
Backlight Power Consumption		-	40.8	43.2	Watt	2
Total Power Consumption		-	44.4	46.8	Watt	2
Life Time		50000	-	-	Hours	3

The performance of the Lamp in LCM, for example lifetime or brightness, is extremely influenced by the characteristics of the DC-AC Inverter. So all the parameters of an inverter should be carefully designed so as not to produce too much leakage current from high-voltage output of the inverter. When you design or order the inverter, please make sure unwanted lighting caused by the mismatch of the lamp and the inverter (no lighting, flicker, etc) never occurs. When you confirm it, the LCD Assembly should be operated in the same condition as installed in your instrument.

Do not attach a conducting tape to lamp connecting wire. If the lamp wire attach to conducting tape, TFT-LCD Module have a low luminance and the inverter has abnormal action because leakage current occurs between lamp wire and conducting tape.

The relative humidity must not exceed 80% non-condensing at temperatures of 40°C or less. At temperatures greater than 40°C, the wet bulb temperature must not exceed 39°C. When operate at low temperatures, the brightness of CCFL will drop and the lifetime of CCFL will be reduced.

Note :

1. V_{dd}=5.0V, F_V=62Hz, f_{CLK}= 88MHz , 25°C, V_{dd} Duration time= 470 *ms*

The Power supply input check pattern definition and dissipation reference as below :

Dot pattern : 0.9A (Max.)

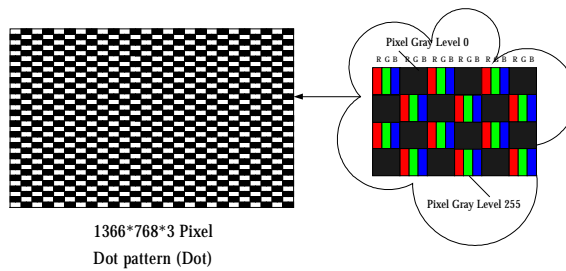

White pattern : 0.69 A

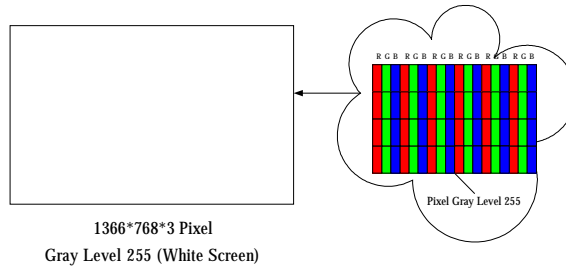

Black pattern : 0.75 A

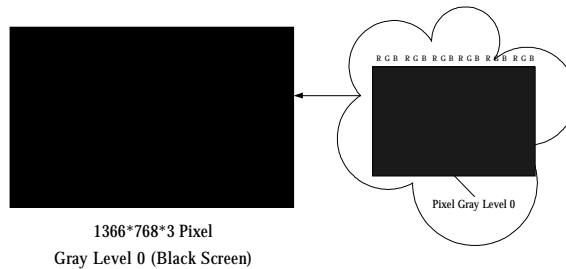

Vertical gray scale pattern : 0.72 A(Typ.)

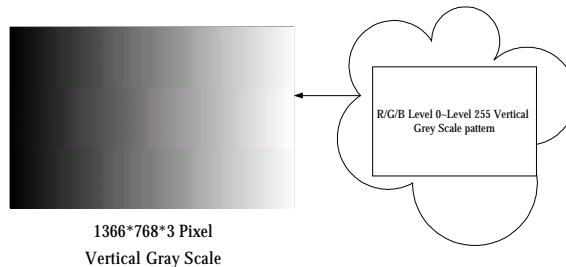

2. The lamp power consumption shown above does include loss of external inverter at 25°C. The used lamp current is the lamp current typical value. Assumption: the efficiency of Inverter is 80%. BLU actual power is 32.64W, BLU power consumption need to consider the efficiency of Inverter, and should be $32.64 / 80\% = 40.8W$ (typ) and 43.2W (max). TTL Power = $40.8 + 3.6 = 44.4 W$. (typ) and 46.8W (max).
3. The life is determined as the time at which luminance of the lamp is 50% compared to that of initial value at the typical lamp current on condition of continuous operating at 25±2°C. The lamp current should fix at 6.5mA(typ.) and then keep the 50000hr(typ.) lamp life



3-2 Interface Connections

- LCD connector (CN1): JAE FI-X30SSL-HF or equivalent
- LVDS Transmitter: SN75LVDS83 (Texas Instruments) or equivalent

Note:

1. All GND (ground) pins should be connected together and should also be connected to the LCD's metal frame. All Vcc (power input) pins should be connected together.

Pin No	Symbol	Description	Note
1	Reserved	Open or High	AUO internal test pin
2	Reserved	Open or High	AUO internal test pin
3	Reserved	Open or High	AUO internal test pin
4	GND	Ground	
5	RIN0-	LVDS Channel 0 [Polarity: Negative]	
6	RIN0+	LVDS Channel 0 [Polarity: Positive]	
7	GND	Ground	
8	RIN1-	LVDS Channel 1 [Polarity: Negative]	
9	RIN1+	LVDS Channel 1 [Polarity: Positive]	
10	GND	Ground	
11	RIN2-	LVDS Channel 2 [Polarity: Negative]	
12	RIN2+	LVDS Channel 2 [Polarity: Positive]	
13	GND	Ground	
14	RINCLK-	LVDS Clock [Polarity: Negative]	
15	RINCLK+	LVDS Clock [Polarity: Positive]	
16	GND	Ground	
17	RIN3-	LVDS Channel 3 [Polarity: Negative]	
18	RIN3+	LVDS Channel 3 [Polarity: Positive]	
19	GND	Ground	
20	Reserved	Open	AUO internal test pin
21	LVDS Option*	Low for JEIDA, High/Open for NS	
22	Reserved	Open	
23	GND	Ground	
24	GND	Ground	
25	GND	Ground	
26	Vdd (+5V)	5V, DC, Regulated	
27	Vdd (+5V)	5V, DC, Regulated	
28	Vdd (+5V)	5V, DC, Regulated	
29	Vdd (+5V)	5V, DC, Regulated	
30	Vdd (+5V)	5V, DC, Regulated	

LVDS Option : H (3.3V) or Open ⇒ NS (Default)

L (GND) ⇒ JEIDA



u LVDS Option = L (GND)

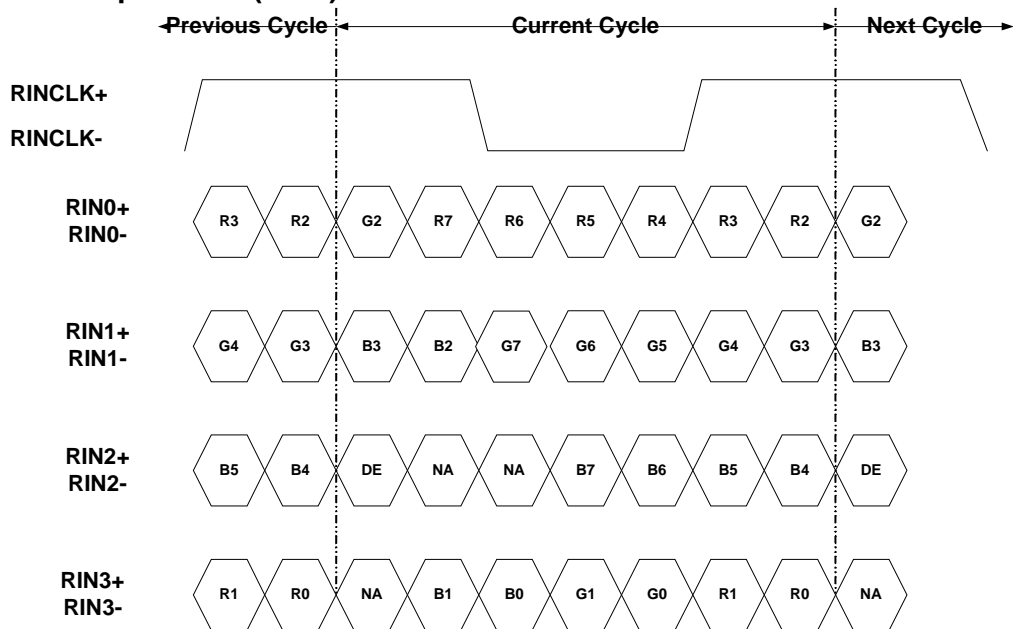

u LVDS Option = H (3.3V) / Open

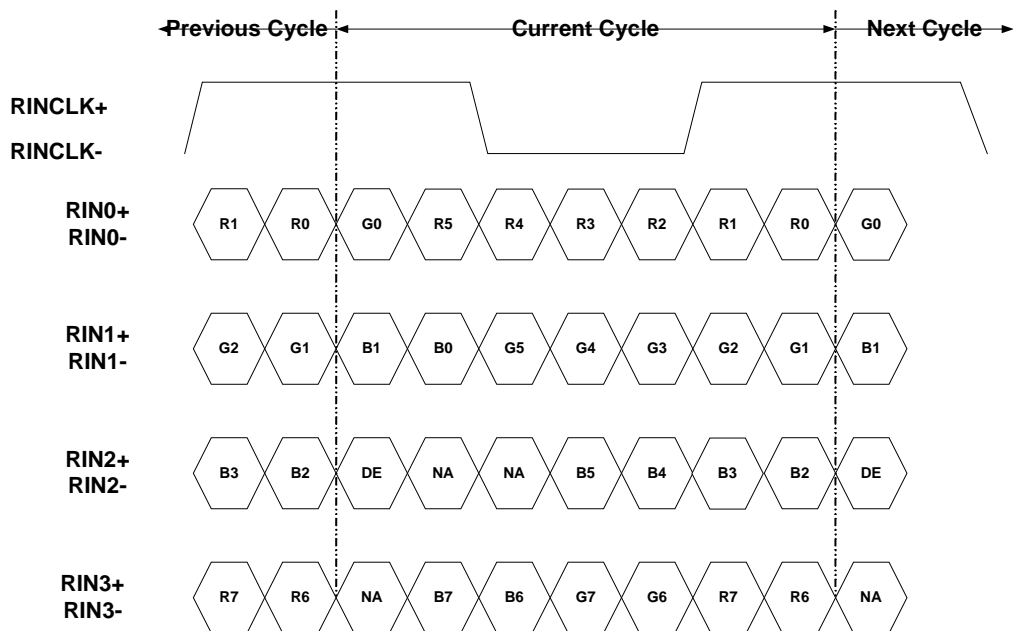



Backlight Connector Pin Configuration

Electrical specification (Lamp spec)

Parameter	Min	Typ	Max	Units	Condition
CCFL current(ICFL)	5.0	6.5	7.0	[mA] rms	(Ta=25°C)
CCFL Frequency(FCFL)	40	55	70	[KHz]	(Ta=25°C)
CCFL Ignition Voltage(Vs)			1580	[Volt] rms	(Ta= 25°C)
CCFL Ignition Voltage(Vs)			2050	[Volt] rms	(Ta= 0°C)
CCFL Voltage (Reference) (VCFL)	894	837	823	[Volt] rms	(Ta=25°C)
CCFL Power consumption (PCFL)		32.64*	34.57	[Watt]	(Ta=25°C)

* Note.

PCFL = ICFL x VCFL x 6 = 6.5 x 837 x 6 = 32.64 W (typ)

PCFL = ICFL x VCFL x 6 = 7 x 823 x 6 = 34.57 W (max)

Lamp connect configuration

Mating connector: SM02B-BHS-1-TB (JST)

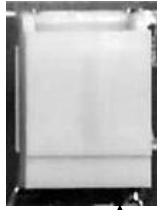

SM02B

(pin1)

Connector mating way: Cable Color: Blue/Pink/White

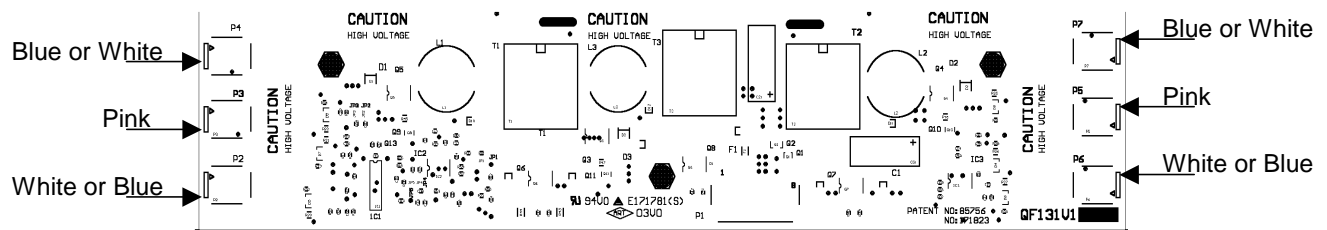



3-3 Signal Timing Specifications

This is the signal timing required at the input of the User connector. All of the interface signal timing should be satisfied with the following specifications for it's proper operation.

*** Timing Table**

Signal	Item	Symbol	Min	Type	Max	Unit
Vertical Section	Period	Tv	789	806	822	Th
	Active	Tdisp (v)	768			Th
	Blanking	Tblk (v)	21	38	54	Th
Horizontal Section	Period	Th	1414	1560	1722	Tclk
	Active	Tdisp (h)	1366			Tclk
	Blanking	Tblk (h)	48	194	356	Tclk
Clock	Frequency	1/Tclk	65	76	88	MHz
Vertical Frequency	Frequency	Fv [⌋]	48 [⌋]	60	75 [⌋]	Hz
Horizontal Frequency	Frequency	Fh [⌋]	39.45 [⌋]		61.65 [⌋]	KHz

*1) CLK signal input must be valid while power supply is applied.

*2) Display position is specific by the rise of DE signal only.

Horizontal display position is specified by the falling edge of 1st CLK right after the rise of DE, is displayed on the left edge of the screen. Vertical display position is specified by the rise of DE after a "Low" level period equivalent to eight times of horizontal period. The 1st data corresponding to one horizontal line after the rise of DE is displayed at the top line of screen.

3.) If a period of DE "High" is less than 1366 CLK or less than 768 lines, the rest of the screen displays black.

4.) The display position does not fit to the screen if a period of DE "High" and the effective data period do not synchronize with each other.



3-4 Signal Timing Waveforms

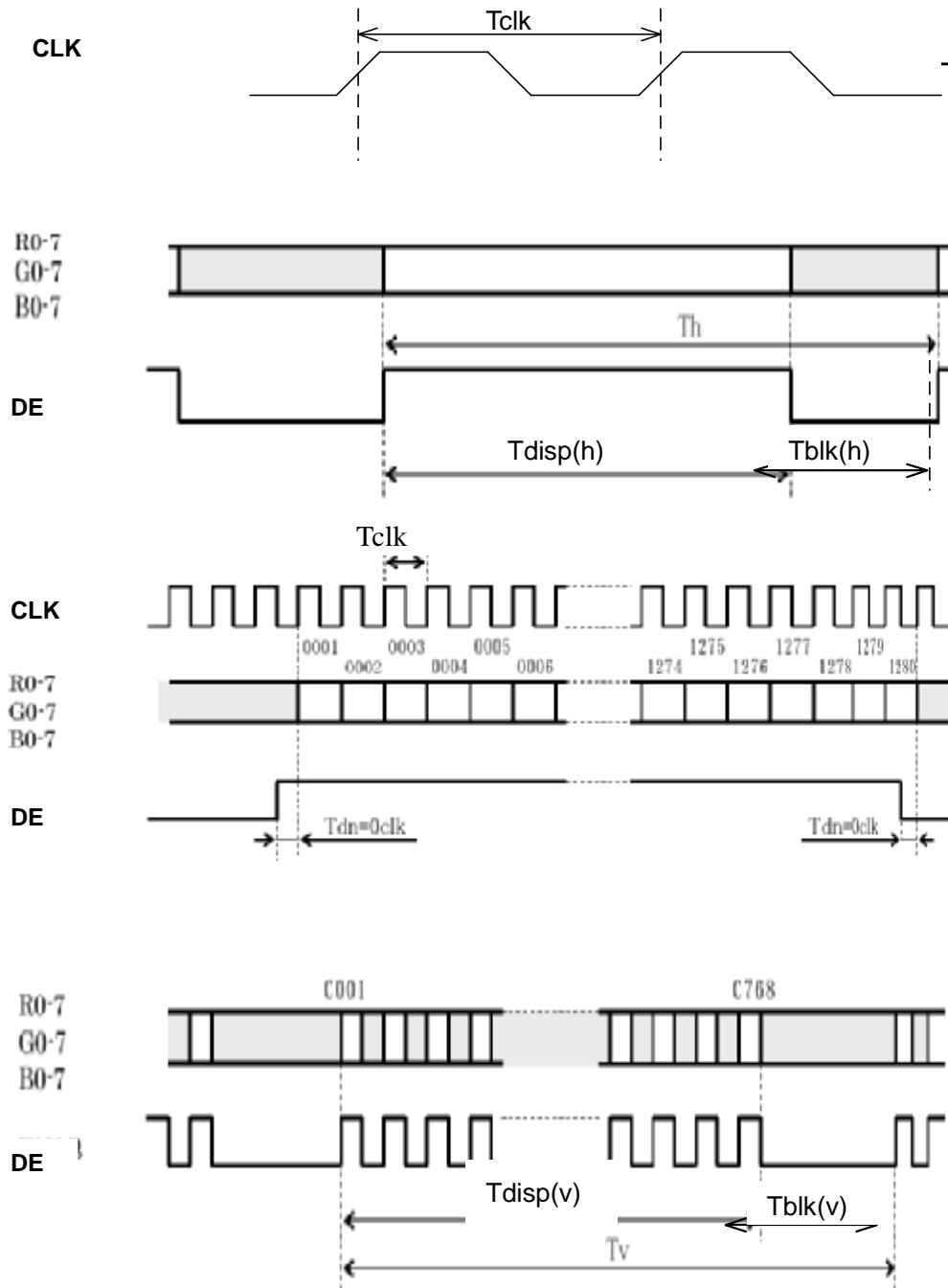



3-5 Color Input Data Reference

The brightness of each primary color (red, green and blue) is based on the 8 bit gray scale data input for the color; the higher the binary input, the brighter the color. The table below provides a reference for color versus data input.

COLOR DATA REFERENCE

Color		Input Color Data																							
		RED								GREEN								BLUE							
		MSB				LSB				MSB				LSB				MSB		LSB					
		R7	R6	R5	R4	R3	R2	R1	R0	G7	G6	G5	G4	G3	G2	G1	G0	B7	B6	B5	B4	B3	B2	B1	B0
Basic Color	Black(L0)	0	0	0	0	0	0	0	0	0	0	0	0	0	0	0	0	0	0	0	0	0	0	0	0
	Red	1	1	1	1	1	1	1	1	0	0	0	0	0	0	0	0	0	0	0	0	0	0	0	0
	Green	0	0	0	0	0	0	0	0	1	1	1	1	1	1	1	1	0	0	0	0	0	0	0	0
	Blue	0	0	0	0	0	0	0	0	0	0	0	0	0	0	0	0	1	1	1	1	1	1	1	1
	Cyan	0	0	0	0	0	0	0	0	1	1	1	1	1	1	1	1	1	1	1	1	1	1	1	1
	Magenta	1	1	1	1	1	1	1	1	0	0	0	0	0	0	0	0	1	1	1	1	1	1	1	1
	Yellow	1	1	1	1	1	1	1	1	1	1	1	1	1	1	1	1	0	0	0	0	0	0	0	0
	White(L255)	1	1	1	1	1	1	1	1	1	1	1	1	1	1	1	1	1	1	1	1	1	1	1	
RED	RED	0	0	0	0	0	0	0	0	0	0	0	0	0	0	0	0	0	0	0	0	0	0	0	0
	RED	0	0	0	0	0	0	0	1	0	0	0	0	0	0	0	0	0	0	0	0	0	0	0	0

	RED	1	1	1	1	1	1	1	0	0	0	0	0	0	0	0	0	0	0	0	0	0	0	0	0
	RED	1	1	1	1	1	1	1	1	0	0	0	0	0	0	0	0	0	0	0	0	0	0	0	0
GREEN	GREEN	0	0	0	0	0	0	0	0	0	0	0	0	0	0	0	0	0	0	0	0	0	0	0	0
	GREEN	0	0	0	0	0	0	0	0	0	0	0	0	0	0	0	1	0	0	0	0	0	0	0	0

	GREEN	0	0	0	0	0	0	0	0	1	1	1	1	1	1	1	0	0	0	0	0	0	0	0	0
	GREEN)	0	0	0	0	0	0	0	0	1	1	1	1	1	1	1	1	0	0	0	0	0	0	0	0
BLUE	BLUE	0	0	0	0	0	0	0	0	0	0	0	0	0	0	0	0	0	0	0	0	0	0	0	0
	BLUE	0	0	0	0	0	0	0	0	0	0	0	0	0	0	0	0	0	0	0	0	0	0	0	1

	BLUE	0	0	0	0	0	0	0	0	0	0	0	0	0	0	0	0	1	1	1	1	1	1	1	0
	BLUE	0	0	0	0	0	0	0	0	0	0	0	0	0	0	0	0	1	1	1	1	1	1	1	1



3-6 Power Sequence

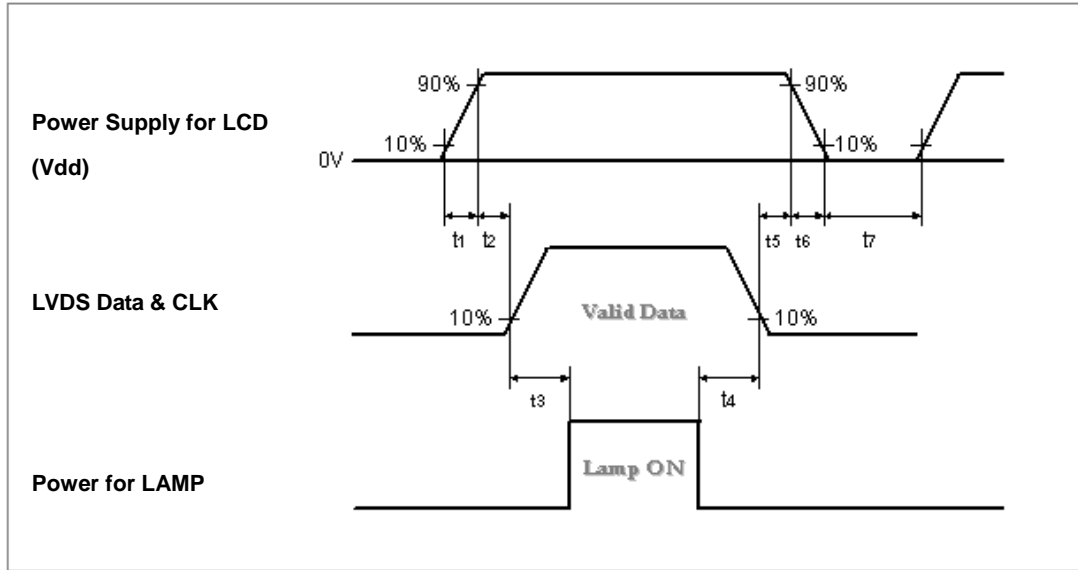

Parameter	Values			Units
	Min.	Typ.	Max.	
t1	0.47	-	20	ms
t2	20	-	50	ms
t3	700	-	-	ms
t4	10	-	-	ms
t5	1	-	50	ms
t6	-	-	300	ms
t7	1000	-	-	ms

Apply the lamp voltage within the LCD operating range. When the backlight turns on before the LCD operation or the LCD turns off before the backlight turns off, the display may momentarily become abnormal.

Caution : The above on/off sequence should be applied to avoid abnormal function in the display. In case of handling, make sure to turn off the power when you plug the cable into the input connector or pull the cable out of the connector.



4. Optical Specification

Optical characteristics are determined after the unit has been 'ON' and stable for approximately 30 minutes in a dark environment at 25°C. The values specified are at an approximate distance 500mm from the LCD surface at a viewing angle of Φ and θ equal to 0°.

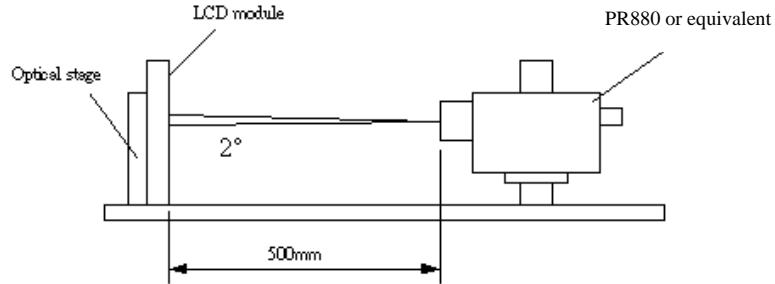

Fig.4-1 Optical measurement equipment and method

Parameter	Symbol	Values			Units	Notes	
		Min.	Typ.	Max.			
Contrast Ratio	CR	600	700			1	
Surface Luminance, white	LWH	350	450		cd/m ²	2	
Luminance Variation	δ_{WHITE}	9 p		1.25		3	
Response Time	T_{γ}		8	16	ms	4,5 (Ton+Toff)	
	Rise Time		Tr	6	12	ms	
	Decay Time		Tf	2	4	ms	
Color Coordinates							
	RED	R _x		0.640			
		R _y		0.330			
	GREEN	G _x		0.290			
		G _y		0.600			
	BLUE	B _x	Typ.-0.03	0.150	Typ.+0.03		
		B _y		0.060			
	WHITE	W _x		0.295			
		W _y		0.305			
Viewing Angle by ELDIM							
	x axis, right($\varphi=0^\circ$)	θ_r	65	80	Degree	Contrast Ratio>10 6, 7	
	x axis, left($\varphi=180^\circ$)	θ_l	65	80			
	y axis, up($\varphi=90^\circ$)	θ_u	65	70			
	y axis, down($\varphi=0^\circ$)	θ_d	55	70			

Note:

1. Contrast Ratio (CR) is defined mathematically as:

$$\text{Contrast ratio (CR)} = \frac{\text{Brightness on the white (L255) state}}{\text{Brightness on the black (L0) state}}$$

2. Surface luminance is luminance value at point 1 across the LCD surface 50cm from the surface with all pixels displaying white. From more information see FIG 4-2. When $I_{BL} = 6.5\text{mA}$, $L_{WH} = 450\text{cd/m}^2$ (typ.) $L_{WH} = L_{on1}$, Where L_{on1} is the luminance with all pixels displaying white at center 1 location.

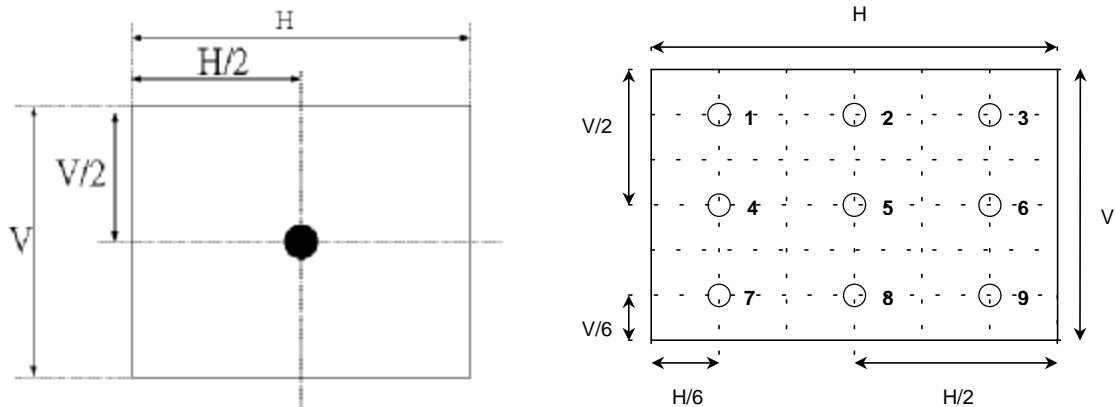

Fig.4-2 Optical measurement point

3. The variation in surface luminance, δ WHITE is defined (center of Screen) as:

$$\delta \text{ WHITE(9P)} = \frac{\text{Maximum}(L_{on1}, L_{on2}, \dots, L_{on9})}{\text{Minimum}(L_{on1}, L_{on2}, \dots, L_{on9})}$$

4. Response time is the time required for the display to transition from white(L255) to black(L0) (Decay Time, $T_{rD} = T_f$) and from black(L0) to white(L255) (Rise Time, $T_{rR} = T_r$). The response time interval is between the 10% and 90% of 1st frame amplitudes. For additional information see FIG 4-3.

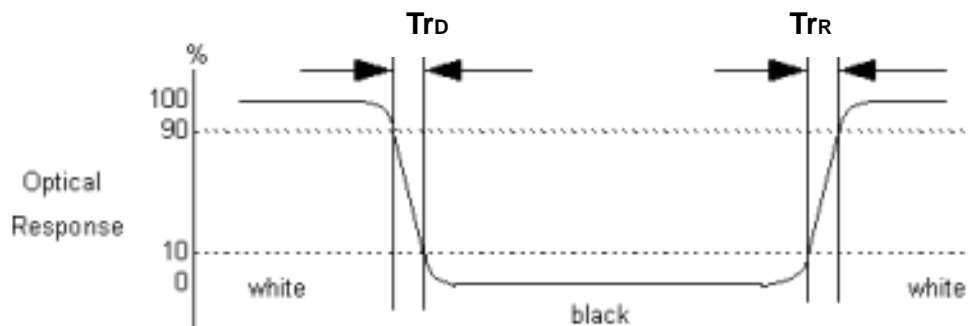

Fig.4-3 Response time

5. Viewing angle is the angle at which the contrast ratio is greater than 10. The angles are determined for the horizontal or x axis and the vertical or y axis with respect to the z axis which is normal to the LCD surface. For more information see FIG 4-5.
6. To be measured with a viewing cone of 1° by Topcon luminance meter ELDIM EZ Contrast 160D.

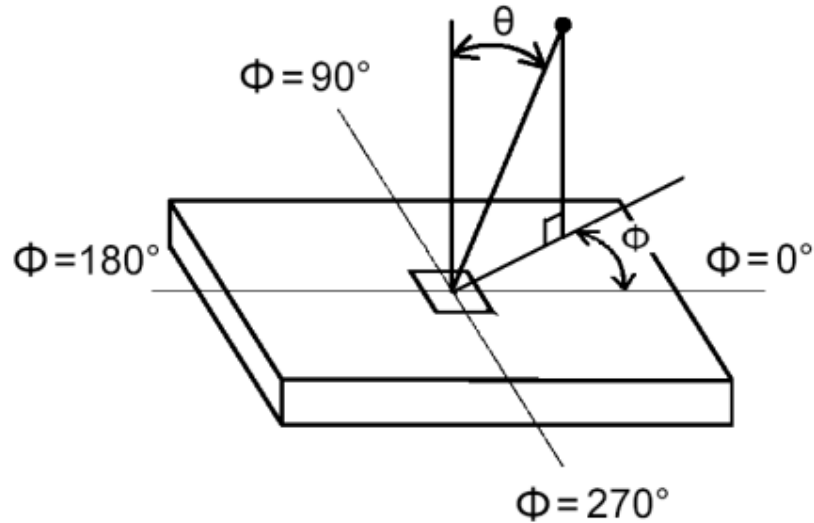

Fig.4-5 Viewing Angle Definition



5. Mechanical Characteristics

The contents provide general mechanical characteristics for the model T200XW02. In addition the figures in the next page are detailed mechanical drawing of the LCD.

Outline Dimension	Horizontal (typ.)	472.0mm
	Vertical (typ.)	276.5mm
	Depth (typ.)	24.0mm(Max.)
Bezel Area	Horizontal (typ.)	448.0mm
	Vertical (typ.)	253.8mm
Active Display Area	Horizontal	443.61mm
	Vertical	249.41mm
Weight	3000g (max.)	
Surface Treatment	HC, 3H	



Front View:

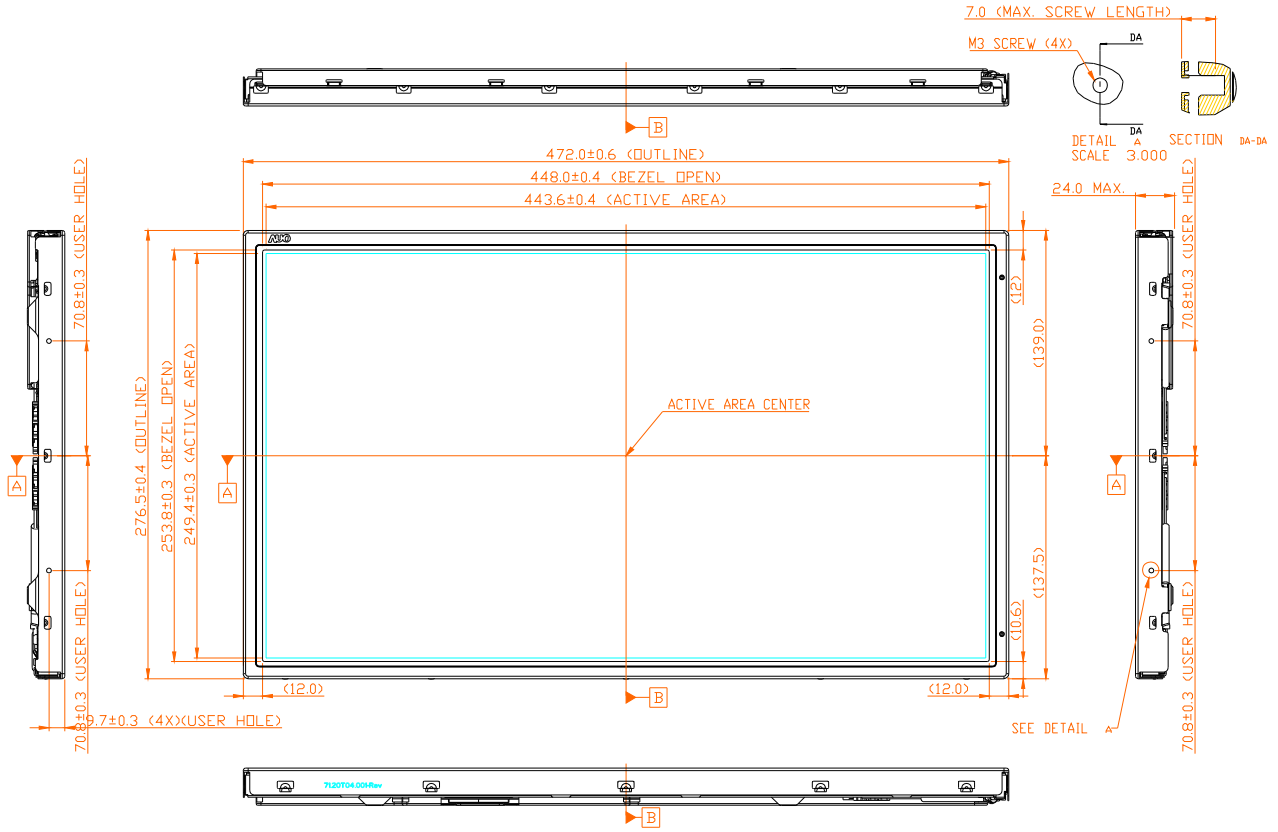

Rear View:

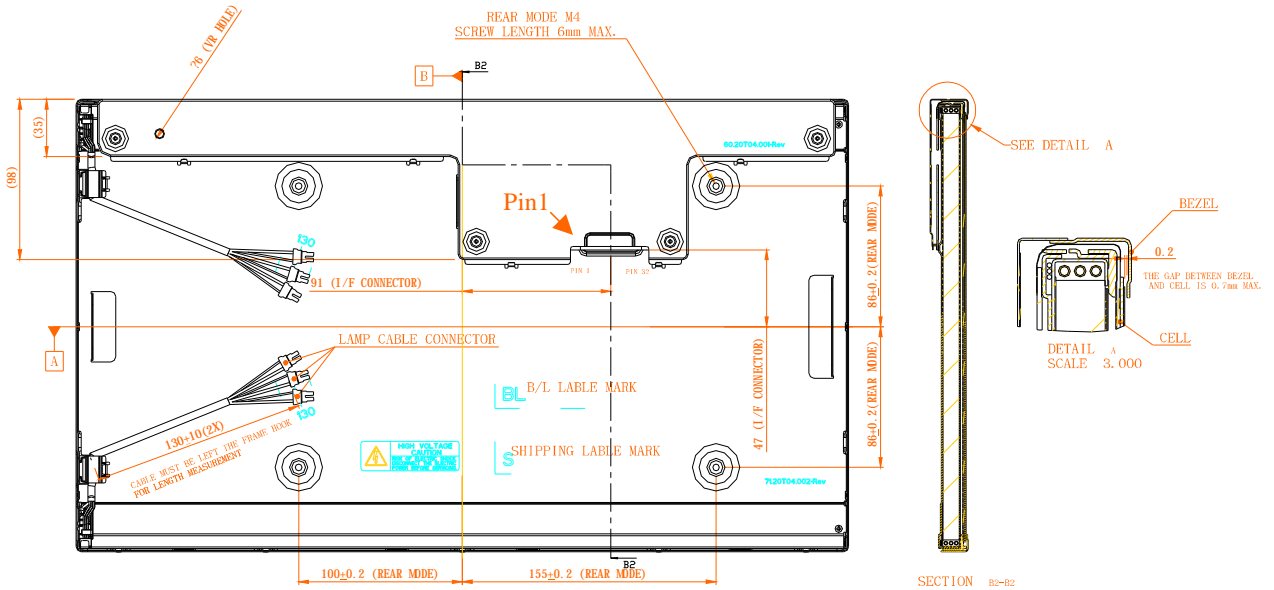



6. International Standard

6-1. Safety

- (1) UL6500, Underwriters Laboratories, Inc. (AUO file number : E204356)
Standard for Safety of Information Technology Equipment Including electrical Business Equipment.
- (2) CAN/CSA C22.2 No. 950-95 Third Edition, Canadian Standards Association, Jan. 28, 1995
Standard for Safety of Information Technology Equipment Including Electrical Business Equipment.
- (3) EN60950 : 1992+A2: 1993+A2: 1993+C3: 1995+A4: 1997+A11: 1997
IEC 950: 1991+A1: 1992+A2: 1993+C3: 1995+A4:1996
IEC 60065
European Committee for Electro technical Standardization (CENELEC)
EUROPEAN STANDARD for Safety of Information Technology Equipment Including Electrical Business Equipment.

6-2. EMC

- a) ANSI C63.4 "Methods of Measurement of Radio-Noise Emissions from Low-Voltage Electrical and Electrical Equipment in the Range of 9kHz to 40GHz. "American National standards Institute(ANSI), 1992
- b) C.I.S.P.R "Limits and Methods of Measurement of Radio Interface Characteristics of Information Technology Equipment." International Special committee on Radio Interference.
- c) EN 55022 "Limits and Methods of Measurement of Radio Interface Characteristics of Information Technology Equipment." European Committee for Electrotechnical Standardization. (CENELEC), 1998



7. Packing

Label Sample



Green Mark Description:

For Pb Free products, AUO will add  for identification.

For RoHS compatible products, AUO will add  for identification.

Note. The Green Mark will be present only when the green documents have been ready by AUO Internal Green Team. (The definition of green design follows the AUO green design checklist)

Carton Label



Cushion set

Carton Box, 320mm(W)x590mm(L)x410mm(H)

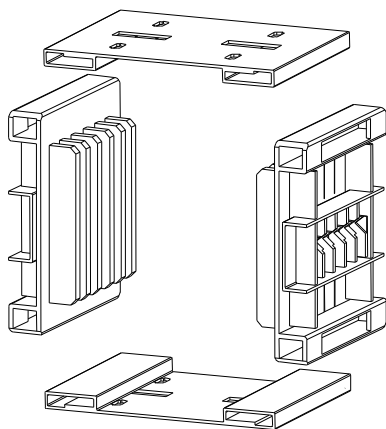



Pallet Package

Air Cargo : (3 *2) *3 layers, total 18 boxes with 108 pcs panel in one pallet

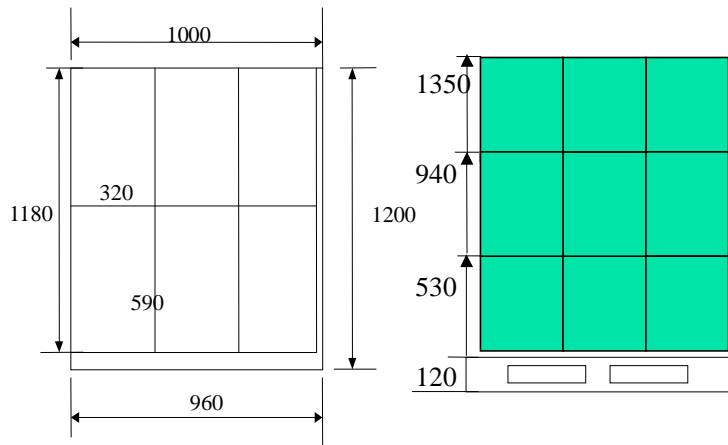

Top view

Side view

Ocean shipping : (3 *2) *5layers, total 30 boxes with 180 pcs panel in one pallet

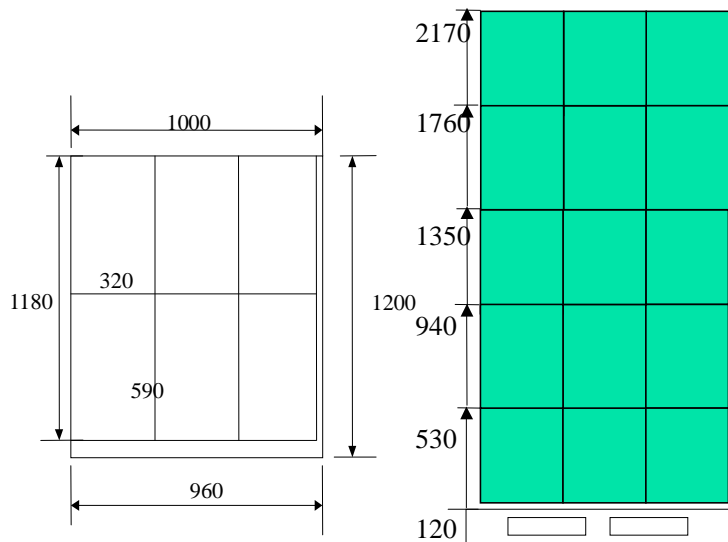

Top view

Side view



8. PRECAUTIONS

Please pay attention to the followings when you use this TFT LCD module.

8-1 MOUNTING PRECAUTIONS

- (1) You must mount a module using holes arranged in four corners or four sides.
- (2) You should consider the mounting structure so that uneven force (ex. Twisted stress) is not applied to module. And the case on which a module is mounted should have sufficient strength so that external force is not transmitted directly to the module.
- (3) Please attach the surface transparent protective plate to the surface in order to protect the polarizer. Transparent protective plate should have sufficient strength in order to resist external force.
- (4) You should adopt radiation structure to satisfy the temperature specification.
- (5) Acetic acid type and chlorine type materials for the cover case are not desirable because the former generates corrosive gas of attacking the polarizer at high temperature and the latter causes circuit break by electro-chemical reaction.
- (6) Do not touch, push or rub the exposed polarizers with glass, tweezers or anything harder than HB pencil lead. And please do not rub with dust clothes with chemical treatment. Do not touch the surface of polarizer for bare hand or greasy cloth. (Some cosmetics are detrimental to the polarizer.)
- (7) When the surface becomes dusty, please wipe gently with absorbent cotton or other soft materials like chamois soaks with petroleum benzene. Normal-hexane is recommended for cleaning the adhesives used to attach front/ rear polarizers. Do not use acetone, toluene and alcohol because they cause chemical damage to the polarizer.
- (8) Wipe off saliva or water drops as soon as possible. Their long time contact with polarizer causes deformations and color fading.
- (9) Do not open the case because inside circuits do not have sufficient strength.

8-2 OPERATING PRECAUTIONS

- (1) The spike noise causes the mis-operation of circuits. It should be lower than following voltage: $V = \pm 200\text{mV}$ (Over and under shoot voltage)
- (2) Response time depends on the temperature. (In lower temperature, it becomes longer..)
- (3) Brightness depends on the temperature. (In lower temperature, it becomes lower.) And in lower temperature, response time (required time that brightness is stable after turned on) becomes longer.



- (4) Be careful for condensation at sudden temperature change. Condensation makes damage to polarizer or electrical contacted parts. And after fading condensation, smear or spot will occur.
- (5) When fixed patterns are displayed for a long time, remnant image is likely to occur.
- (6) Module has high frequency circuits. Sufficient suppression to the electromagnetic interference shall be done by system manufacturers. Grounding and shielding methods may be important to minimize the interface.

8-3 ELECTROSTATIC DISCHARGE CONTROL

Since a module is composed of electronic circuits, it is not strong to electrostatic discharge. Make certain that treatment persons are connected to ground through wrist band etc. And don't touch interface pin directly.

8-4 PRECAUTIONS FOR STRONG LIGHT EXPOSURE

Strong light exposure causes degradation of polarizer and color filter.

8-5 STORAGE

When storing modules as spares for a long time, the following precautions are necessary.

- (1) Store them in a dark place. Do not expose the module to sunlight or fluorescent light. Keep the temperature between 5°C and 35°C at normal humidity.
- (2) The polarizer surface should not come in contact with any other object. It is recommended that they be stored in the container in which they were shipped.

8-6 HANDLING PRECAUTIONS FOR PROTECTION FILM

- (1) The protection film is attached to the bezel with a small masking tape. When the protection film is peeled off, static electricity is generated between the film and polarizer. This should be peeled off slowly and carefully by people who are electrically grounded and with well ion-blown equipment or in such a condition, etc.
- (2) When the module with protection film attached is stored for a long time, sometimes there remains a very small amount of glue still on the Bezel after the protection film is peeled off.
- (3) You can remove the glue easily. When the glue remains on the Bezel or its vestige is recognized, please wipe them off with absorbent cotton waste or other soft material like chamois soaked with normal-hexane.