



Product Description: T230XW01 TFT-LCD PANEL with RoHS Guarantee			
AUO Model Name: T230XW01 V3			
Customer Part No/Project Name:			
Customer Signature	Date	AUO	2007/5/23

Document Version : 3.5
Date : 2007/5/23



Product Specifications

**23" WXGA Color TFT-LCD Module
Model Name: T230XW01 V3**

**() Preliminary Specifications
(*) Final Specifications**



Contents

No	ITEM
	COVER
	CONTENTS
	RECORD OF REVISIONS
1	GENERAL DESCRIPTION
2	ABSOLUTE MAXIMUM RATINGS
3	ELECTRICAL SPECIFICATIONS
3-1	ELECTRICAL CHARACTERISTICS
3-2	INTERFACE CONNECTIONS
3-3	SIGNAL TIMING SPECIFICATIONS
3-4	SIGNAL TIMING WAVEFORMS
3-5	COLOR INPUT DATA REFERENCE
3-6	POWER SEQUENCE
4	OPTICAL SPECIFICATIONS
5	MECHANICAL CHARACTERISTICS
6	RELIABILITY
7	INTERNATIONAL STANDARDS
7-1	SAFETY
7-2	EMC
8	PACKING (Green Mark Description)
9	PRECAUTIONS



Record of Revision

Version	Date	No	Old Description	New Description	Remark
3.0	06/10/13	-	-	First Draft	
3.1	06/10/30	8	Inrush current	Update from 1.2mA to 3mA	
		13	Timing table	Align the timing spec with other model which using the same ASIC.	
	06/10/30	16,17	Sequence	Align with other model which using the same ASIC.	
3.2	06/11/27	All		Spec format updated	
3.3	06/12/15	Appendix	Luminance variation:30%	Luminance variation:20%	
			Uniformity: 1.5(max)	Uniformity: 1.7(max)	
3.4	07/2/14	12	Timing table	Updated Horizontal section Period and Blanking	
3.5	07/5/23	18	Viewing angle	To add the min. value of viewing angle sepc	



1. General Description

This specification applies to the 23.0 inch Color TFT-LCD Module T230XW01 V3. This LCD module has a TFT active matrix type liquid crystal panel 1366x768 pixels, and diagonal size of 23.0 inch. This module supports 1366x768 XGA-WIDE mode (Non-interlace).

Each pixel is divided into Red, Green and Blue sub-pixels or dots which are arranged in vertical stripes. Gray scale or the brightness of the sub-pixel color is determined with a 8-bit (6bit+FRC) gray scale signal for each dot.

The T230XW01 V3 has been designed to apply the 8-bit 1 channel LVDS interface method. It is intended to support displays where high brightness, wide viewing angle, high color saturation, and high color depth are very important.

The T230XW01 V3 model is RoHS verified, which can be distinguished on panel label.

* General Information

Items	Specification	Unit	Note
Active Screen Size	22.95 inches		
Display Area	508.152 (H) x 285.696(V)	mm	
Outline Dimension	546.0(H) x 318.3(V) x 46.0(D)	mm	With inverter
Driver Element	a-Si TFT active matrix		
Display Colors	16.7M	Colors	
Number of Pixels	1366 x 768	Pixel	
Pixel Pitch	0.372	mm	
Pixel Arrangement	RGB vertical stripe		
Display Mode	Normally White		
Surface Treatment	AG, 3H		Haze= 25



2. Absolute Maximum Ratings

The following are maximum values which, if exceeded, may cause permanent damage to the unit.

Item	Symbol	Min	Max	Unit	Conditions
Logic/LCD Drive Voltage	Vcc	-0.3	14	[Volt]	Note 1
Input Voltage of Signal	Vin	-0.3	3.6	[Volt]	Note 1
BLU Input Voltage	VDDB	21	27	[Volt]	Note 1
External Analog Dimming Control Voltage	VDIM	0	5.5	[Volt]	Note 1
BLU Brightness Control Voltage	VBLON	0	7	[Volt]	Note 1
External/Internal PWM Dimming Control Voltage	PDIM	0	5.5	[Volt]	Note 1
Operating Temperature	TOP	0	+50	[°C]	Note 2
Operating Humidity	HOP	10	90	[%RH]	Note 2
Storage Temperature	TST	-20	+60	[°C]	Note 2
Storage Humidity	HST	10	90	[%RH]	Note 2

Note 1: Duration:50 msec.

Note 2 : Maximum Wet-Bulb should be 39°C and No condensation.

The relative humidity must not exceed 90% non-condensing at temperatures of 40°C or less. At temperatures greater than 40°C, the wet bulb temperature must not exceed 39°C.

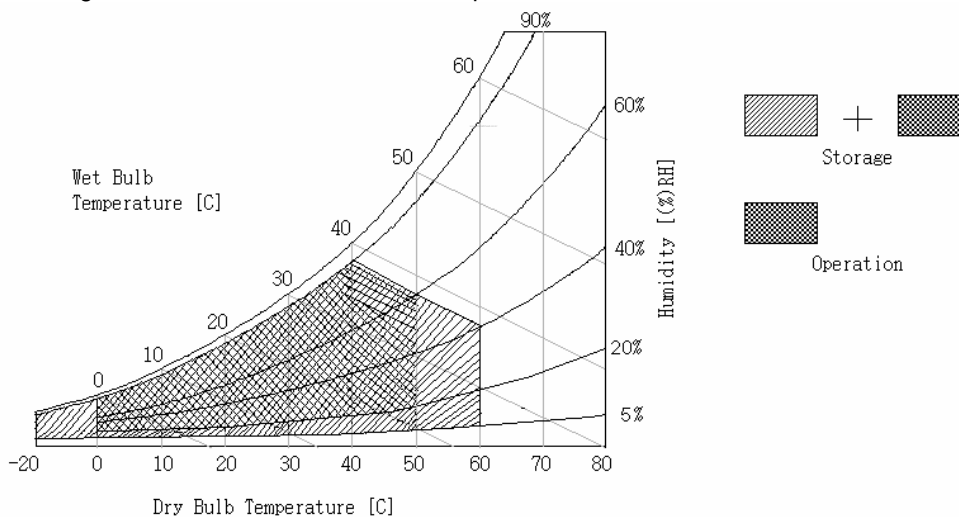



3. Electrical Specifications

The T230XW01 V3 requires two power inputs. One is employed to power the LCD electronics and to drive the TFT array and liquid crystal. The second input power for the BLU, is to power inverter..

3-1 Electrical Characteristics

		Parameter	Values			Unit	Notes
			Min	Typ	Max		
LCD:							
Power Supply Input Voltage		Vcc	10.8	12.0	13.2	Vdc	1
Power Supply Input Current		Icc	-	0.27	0.4	A	2
Power Consumption		Pc	-	3.24	4.8	Watt	2
Inrush Current		I _{RUSH}	-	-	3	Apeak	3
LVDS Interface	Differential Input High Threshold Voltage	VTH			100	mV	4
	Differential Input Low Threshold Voltage	VTL	-100			mV	4
	Common Input Voltage	VICM	1.1	1.25	1.4	V	
CMOS Interface	Input High Threshold Voltage	VIH (High)	2.4		3.3	Vdc	
	Input Low Threshold Voltage	VIL (Low)	0		0.7	Vdc	
Backlight Power Consumption		PDDDB	45.6	50.4	55.2	Watt	8
Total Power Consumption				54.03	59.52		
Life Time			50,000	60,000		Hours	9



Note :

1. The ripple voltage should be controlled under 10% of V_{CC}
2. $V_{CC}= 12.0V$, $f_v = 62Hz$, $f_{CLK}=85Mhz$, $25^{\circ}C$, Test Pattern : White Pattern
3. Measurement condition :

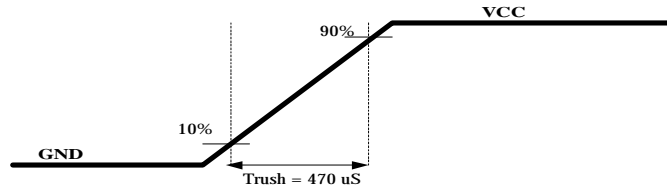

4. $V_{CIM} = 1.2V$

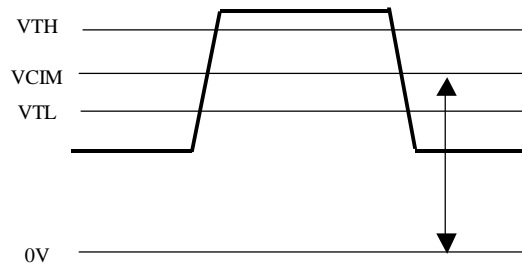

5. The performance of the Lamp in LCM, for example life time or brightness, is extremely influenced by the characteristics of the DC-AC Inverter. So all the parameters of an inverter should be carefully designed so as not to produce too much leakage current from high-voltage output of the inverter. When you design or order the inverter, please make sure unwanted lighting caused by the mismatch of the lamp and the inverter (no lighting, flicker, etc) never occurs. When you confirm it, the LCD Assembly should be operated in the same condition as installed in your instrument.
6. Do not attach a conducting tape to lamp connecting wire. If the lamp wire attach to conducting tape, TFT-LCD Module have a low luminance and the inverter has abnormal action because leakage current occurs between lamp wire and conducting tape.
7. The relative humidity must not exceed 80% non-condensing at temperatures of $40^{\circ}C$ or less. At temperatures greater than $40^{\circ}C$, the wet bulb temperature must not exceed $39^{\circ}C$. When operate at low temperatures, the brightness of CCFL will drop and the life time of CCFL will be reduced.
8. The measured data is without boost function
9. Lifetime is defined and judged when analog and PWM dimming are maximum values



3-2 Interface Connections

LCD Panel Driving Signal Connector Type and Pin Assignment are as follows:

Connector on Panel: **FI-X30SSL-HF** (Manufactured by JAE) or Equivalent

Mating connector: FI-30C2L (Manufactured by JAE) or Equivalent

Pin No	Symbol	Description	Default
1	VCC	+12V, DC, Regulated	
2	VCC	+12V, DC, Regulated	
3	VCC	+12V, DC, Regulated	
4	VCC	+12V, DC, Regulated	
5	GND	Ground and Signal Return	
6	GND	Ground and Signal Return	
7	GND	Ground and Signal Return	
8	GND	Ground and Signal Return	
9	LVDS Option	Low/Open for Normal (NS), High for JEIDA	NS mode
10	Reserved	NC	AUO internal test
11	GND	Ground and Signal Return for LVDS	
12	RIN0-	LVDS Channel 0 negative	
13	RIN0+	LVDS Channel 0 positive	
14	GND	Ground and Signal Return for LVDS	
15	RIN1-	LVDS Channel 1 negative	
16	RIN1+	LVDS Channel 1 positive	
17	GND	Ground and Signal Return for LVDS	
18	RIN2-	LVDS Channel 2 negative	
19	RIN2+	LVDS Channel 2 positive	
20	GND	Ground and Signal Return for LVDS	
21	RCLK-	LVDS Clock negative	
22	RCLK+	LVDS Clock positive	
23	GND	Ground and Signal Return for LVDS	
24	RIN3-	LVDS Channel 3 negative	
25	RIN3+	LVDS Channel 3 positive	
26	GND	Ground and Signal Return for LVDS	
27	Reserved	NC	AUO internal test
28	Reserved	NC	AUO internal test
29	GND	Ground and Signal Return	
30	GND	Ground and Signal Return	

Note:

1. All GND (ground) pins should be connected together and should also be connected to the LCD's metal frame. All Vcc (power input) pins should be connected together.
2. For Pin 10, 27 and 28, panel will not damage if negligently connect these pins to high or low.



LVDS Option = High

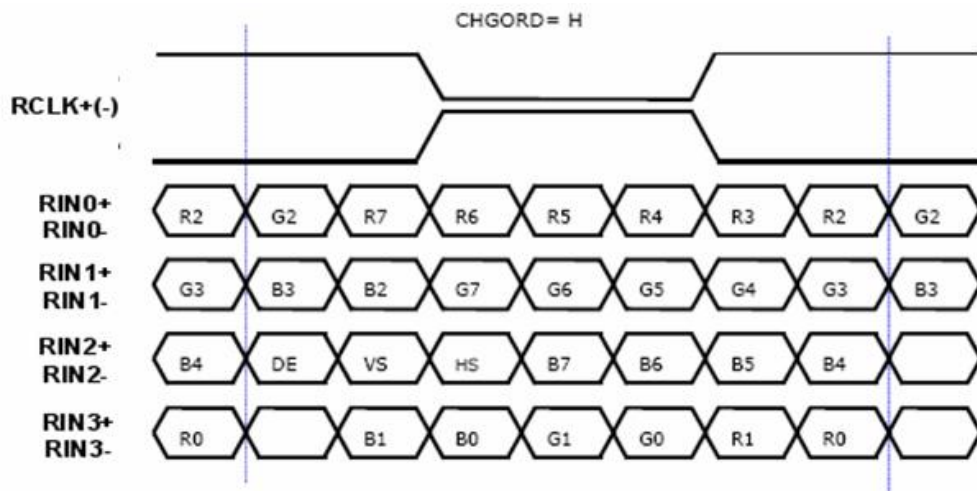

Note: R/G/B7s are MSBs and R/G/B0s are LSBs

LVDS Option = Low or Open

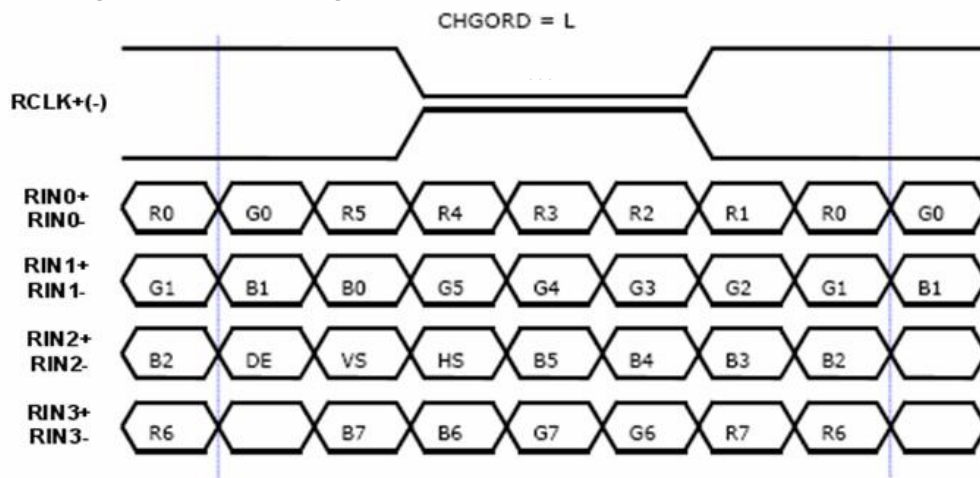

Note: R/G/B7s are MSBs and R/G/B0s are LSBs



BACKLIGHT CONNECTOR PIN CONFIGURATION

1 · Electrical specification

Item	Symb.	Condition	Spec			Units	Note.	
			Min	Typ	Max			
Input Voltage	VDDB	-	21.6	24	26.4	VDC		
Input Current	IDDB	VDDB=24V	1.9	2.1	2.3	ADC	1	
Input Power	PDDB	VDDB=24V	45.6	50.4	55.2	W	1	
Inrush Current	IRUSH	VDDB=24V			3.15	ADC	1,2	
On/Off Control Voltage	VBLON	ON	VDDB=24V	2	-	5	VDC	
		OFF	VDDB=24V	0	-	0.8		
On/Off Control Current	IBLON	VDDB=24V	0		1.5	mADC		
Dimming Control Voltage	VDIM	MAX	VDDB=24V		3.3		VDC	1
		MIN	VDDB=24V		0			
PWM Function	V_PWM	MAX	VDDB=24V	2		5	VDC	
		MIN	VDDB=24V	0		0.8		
External PWM Control Current	I_EPWM	VDDB=24V			1.5	mADC		
Ext PWM Duty Ratio	D_EPWM	VDDB=24V	20		100	%		
Ext PWM Freq	F_EPWM	VDDB=24V	120		300	Hz		

Note1 : VDIM= 1.6V (Ta=25±5°C, Turn on for 45minutes)

Note 2 : Measurement condition Rising time = 20 ms (VDDB : 10%~90%);

2 · Input specification

CN1: JST_S14B-PH-SM4-TB or equivalent

No	Symbol	Description	Default
1	VDDB (Main Power)	DC input 24.0 VDC	24V
2	VDDB (Main Power)	DC input 24.0 VDC	24V
3	VDDB (Main Power)	DC input 24.0 VDC	24V
4	VDDB (Main Power)	DC input 24.0 VDC	24V
5	VDDB (Main Power)	DC input 24.0 VDC	24V
6	GND	Ground	GND
7	GND	Ground	GND
8	GND	Ground	GND
9	GND	Ground	GND
10	GND	Ground	GND
11	VDIM (LCD Bright)	GND (0V) 80% / Open (1.6V) 100% / High (3.3V) 120%, Luminance	100%
12	VBLON (Enable Pin)	BL On-Off: Open/High (3.3V) for BL On as default	On
13	PDIM	External PWM (AC Signal Control Duty) Open/High (3.3V, 100% Duty) for 100% Brightness	100%
14	BLGND	Ground and Current Return	GND



3-3 Signal Timing Specifications

This is the signal timing required at the input of the User connector. All of the interface signal timing should be satisfied with the following specifications for it's proper operation.

* Timing Table

DE only Mode

Signal	Item	Symbol	Min	Type	Max	Unit
Vertical Section	Period	Tv	784	806	1063	Th
	Active	Tdisp (v)	—	768	—	Th
	Blanking	Tblk (v)	16	38	295	Th
Horizontal Section	Period	Th	1434	1560	2000	Tclk
	Active	Tdisp (h)	—	1366	—	Tclk
	Blanking	Tblk (h)	68	194	634	Tclk
Clock	Period	Tclk	11.36	13.16	18.19	ns
	Frequency	Freq	55	76	85	MHz
Vertical Frequency	Frequency	Vs	48	60	75	Hz
Horizontal Frequency	Frequency	Hs	39.45		61.65	KHz

- 1.) Display position is specific by the rise of DE signal only.
Horizontal display position is specified by the rising edge of 1st DCLK after the rise of 1st DE, is displayed on the left edge of the screen.
Vertical display position is specified by the rise of DE after a "Low" level period equivalent to eight times of horizontal period. The 1st data corresponding to one horizontal line after the rise the of 1st DE is displayed at the top line of screen.
- 3.) If a period of DE "High" is less than 1366 DCLK or less than 768 lines, the rest of the screen displays black.
- 4.) The display position does not fit to the screen if a period of DE "High" and the effective data period do not synchronize with each other.



3-4 Signal Timing Waveforms

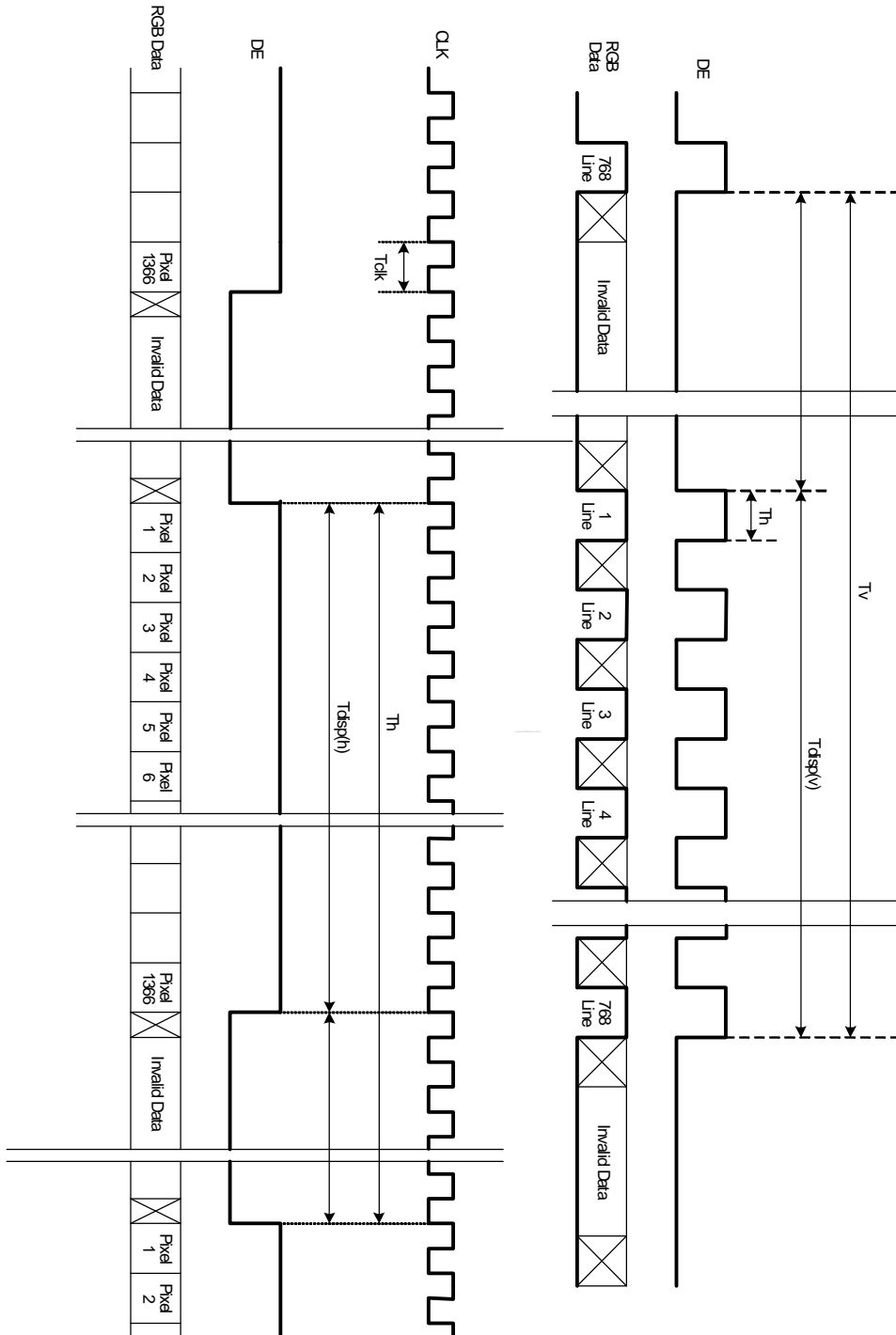



3-5 Color Input Data Reference

The brightness of each primary color (red, green and blue) is based on the 8 bit gray scale data input for the color; the higher the binary input, the brighter the color. The table below provides a reference for color versus data input.

COLOR DATA REFERENCE

Color		Input Color Data																							
		RED								GREEN								BLUE							
		MSB				LSB				MSB				LSB				MSB				LSB			
		R7	R6	R5	R4	R3	R2	R1	R0	G7	G6	G5	G4	G3	G2	G1	G0	B7	B6	B5	B4	B3	B2	B1	B0
Basic Color	Black	0	0	0	0	0	0	0	0	0	0	0	0	0	0	0	0	0	0	0	0	0	0	0	0
	Red(255)	1	1	1	1	1	1	1	1	0	0	0	0	0	0	0	0	0	0	0	0	0	0	0	0
	Green(255)	0	0	0	0	0	0	0	0	1	1	1	1	1	1	1	1	0	0	0	0	0	0	0	0
	Blue(255)	0	0	0	0	0	0	0	0	0	0	0	0	0	0	0	0	1	1	1	1	1	1	1	1
	Cyan	0	0	0	0	0	0	0	0	1	1	1	1	1	1	1	1	1	1	1	1	1	1	1	1
	Magenta	1	1	1	1	1	1	1	1	0	0	0	0	0	0	0	0	1	1	1	1	1	1	1	1
	Yellow	1	1	1	1	1	1	1	1	1	1	1	1	1	1	1	1	0	0	0	0	0	0	0	0
White	1	1	1	1	1	1	1	1	1	1	1	1	1	1	1	1	1	1	1	1	1	1	1	1	
RED	RED(000)	0	0	0	0	0	0	0	0	0	0	0	0	0	0	0	0	0	0	0	0	0	0	0	0
	RED(001)	0	0	0	0	0	0	0	1	0	0	0	0	0	0	0	0	0	0	0	0	0	0	0	0

	RED(254)	1	1	1	1	1	1	1	0	0	0	0	0	0	0	0	0	0	0	0	0	0	0	0	0
RED(255)	1	1	1	1	1	1	1	1	0	0	0	0	0	0	0	0	0	0	0	0	0	0	0	0	
GREEN	GREEN(000)	0	0	0	0	0	0	0	0	0	0	0	0	0	0	0	0	0	0	0	0	0	0	0	0
	GREEN(001)	0	0	0	0	0	0	0	0	0	0	0	0	0	0	0	1	0	0	0	0	0	0	0	0

	GREEN(254)	0	0	0	0	0	0	0	0	1	1	1	1	1	1	1	0	0	0	0	0	0	0	0	0
GREEN(255)	0	0	0	0	0	0	0	0	1	1	1	1	1	1	1	1	0	0	0	0	0	0	0	0	
BLUE	BLUE(000)	0	0	0	0	0	0	0	0	0	0	0	0	0	0	0	0	0	0	0	0	0	0	0	0
	BLUE(001)	0	0	0	0	0	0	0	0	0	0	0	0	0	0	0	0	0	0	0	0	0	0	0	1

	BLUE(254)	0	0	0	0	0	0	0	0	0	0	0	0	0	0	0	0	1	1	1	1	1	1	1	0
BLUE(255)	0	0	0	0	0	0	0	0	0	0	0	0	0	0	0	0	1	1	1	1	1	1	1	1	



3-6 Power Sequence

3.6.1 Power Sequence for LCD

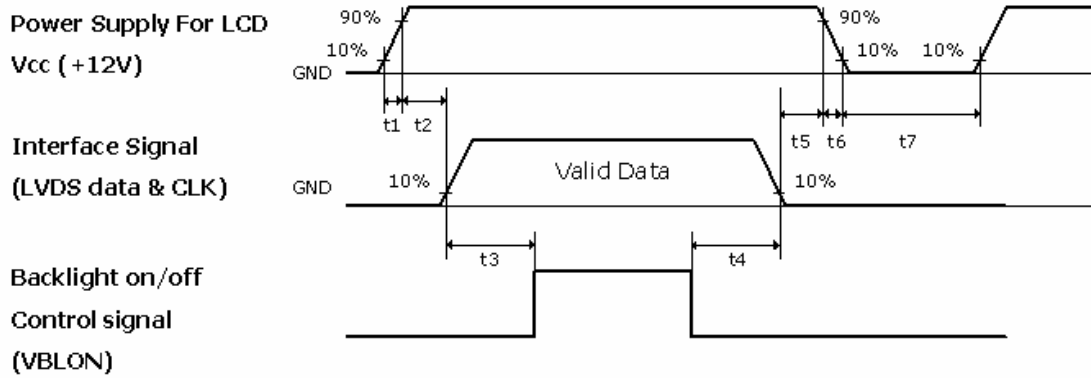

Parameter	Values			Units
	Min.	Typ.	Max.	
t1	0.47	-	20	ms
t2	12	-	50	ms
t3	400	-	-	ms
t4	10	-	-	ms
t5	0.5	-	50	ms
t6	-	-	300	ms
t7	1	-	-	s

Apply the lamp voltage within the LCD operating range. When the backlight turns on before the LCD operation or the LCD turns off before the backlight turns off, the display may momentarily become abnormal.

Caution : The above on/off sequence should be applied to avoid abnormal function in the display. In case of handling, make sure to turn off the power when you plug the cable into the input connector or pull the cable out of the connector.





3.6.2 Power Sequence for Inverter

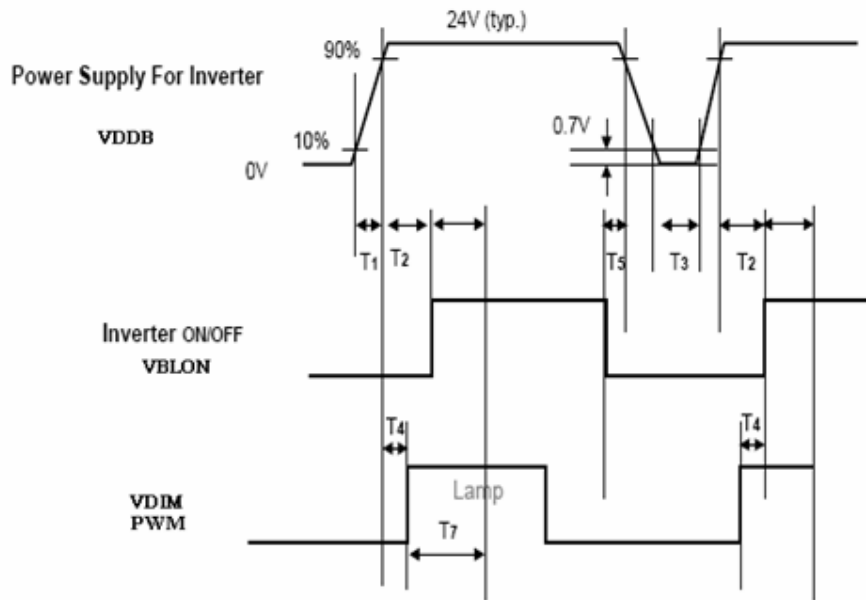

Deep condition for Inverter

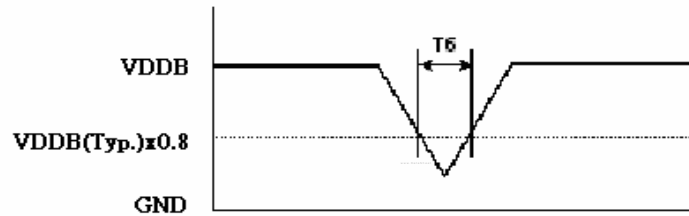

Parameter	Values			Units
	Min.	Typ.	Max.	
T1	20	-	-	ms
T2	50	-	-	ms
T3	200	-	-	ms
T4	0	-	-	ms
T5	60	-	-	ms
T6	-	-	10	ms
T7	1000	-	-	ms

Note:

In case of $t_3=200\text{ms}$, uniformity and optical performance are not guaranteed. But it will not damage power supplier and inverter.

In case of $t_7=1000\text{ms}$, inverter operation is guaranteed. But brightness control depends on lamp response time.



4. Optical Specifications

Optical characteristics are determined after the unit has been 'ON' and stable for approximately 30 minutes in a dark environment at 25°C. The values specified are at an approximate distance 50cm from the LCD surface at a viewing angle of Φ and θ equal to 0°.

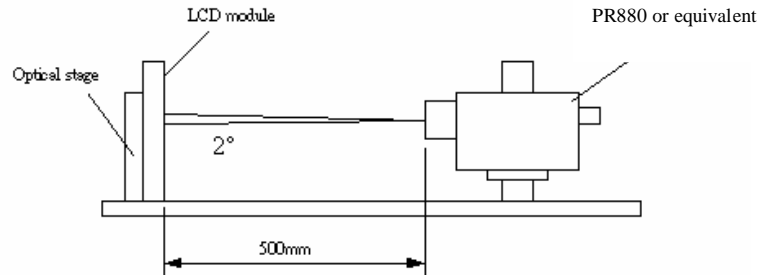

Fig.4-1 Optical measurement equipment and method

Parameter	Symbol	Values			Units	Notes
		Min.	Typ.	Max.		
Contrast Ratio	CR	550	700			1
Surface Luminance, white	LWH	400	500		cd/m ²	2
Luminance Variation	δ_{WHITE}	5 p		1.3		3
Response Time			8	16		4
	Rise Time	Ton	7	13	ms	(Ton+Toff)
	Decay Time	Toff	—	3	ms	
Color Coordinates						
	RED	R _x	0.638			
		R _y	0.337			
	GREEN	G _x	0.299			
		G _y	0.604			
	BLUE	B _x	0.145			
		B _y	0.059			
	WHITE	W _x	0.280			
		W _y	0.292			
Viewing Angle						CR>10
	x axis, right($\varphi=0^\circ$)	θ_r	65	80	Degree	5, 6
	x axis, left($\varphi=180^\circ$)	θ_l	65	80	Degree	5, 6
	y axis, up($\varphi=90^\circ$)	θ_u	65	80	Degree	5, 6
	y axis, down ($\varphi=0^\circ$)	θ_d	65	80	Degree	5, 6



Note:

1. Contrast Ratio (CR) is defined mathematically as:

$$\text{Contrast ratio (CR)} = \frac{\text{Brightness on the white (Lon3)}}{\text{Brightness on the black (Loff3)}}$$

2. Surface luminance is luminance value at point 3 across the LCD surface 50cm from the surface with all pixels displaying white. From more information see FIG 4-2. When $V_{DDB} = 24V$, $I_{DDB} = 2.54A$. $L_{WH} = L_{on3}$. Where L_{on3} is the luminance with all pixels displaying white at center location point 3.
3. The variation in surface luminance, δ_{WHITE} is defined (center of Screen) as:

$$\delta_{WHITE(9P)} = \frac{\text{Maximum}(L_{on1}, L_{on2}, \dots, L_{on5})}{\text{Minimum}(L_{on1}, L_{on2}, \dots, L_{on5})}$$
4. Response time is the time required for the display to transition from white(L_{on}) to black(L_{off}) (Decay Time, $T_{rD} = T_{off}$) and from black(L_{off}) to white(L_{on}) (Rise Time, $T_{rR} = T_{on}$). The response time interval is between the 10% and 90% of 1st frame amplitudes. For additional information see FIG 4-3.
5. Viewing angle is the angle at which the contrast ratio is greater than 10. The angles are determined for the horizontal or x axis and the vertical or y axis with respect to the z axis which is normal to the LCD surface. For more information see FIG 4-5.
6. To be measured with a viewing cone of 1° by Topcon luminance meter ELDIM EZ Contrast 160D.

FIG. 4-2 Luminance

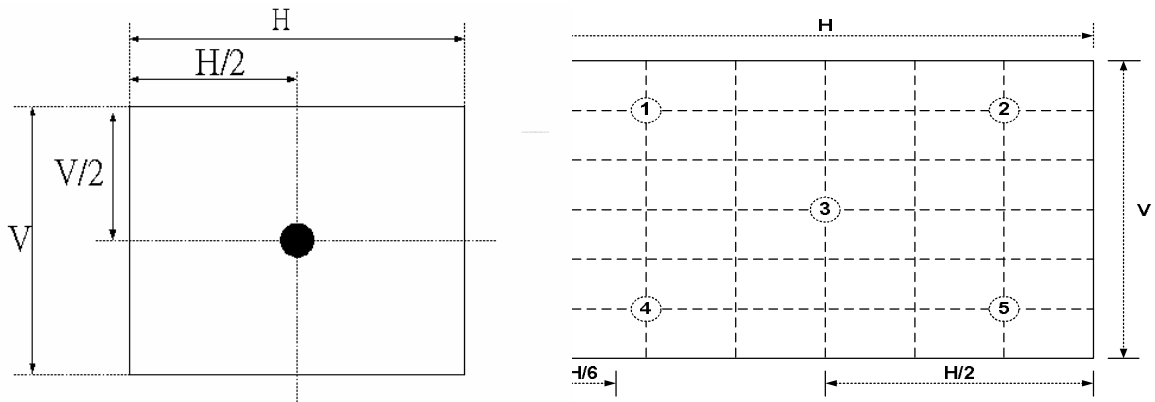

FIG.4-3 Response Time

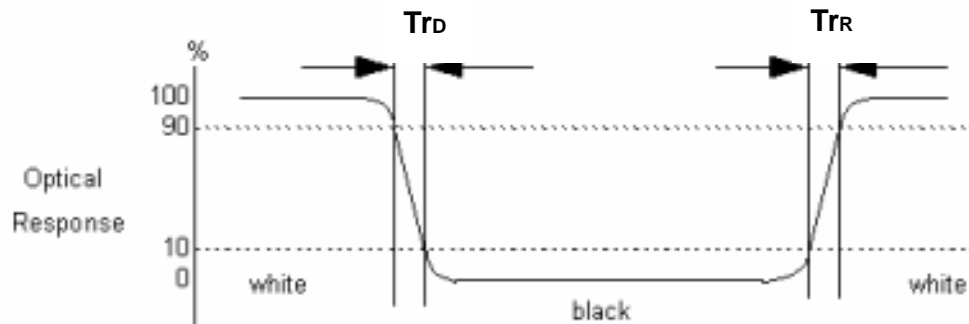
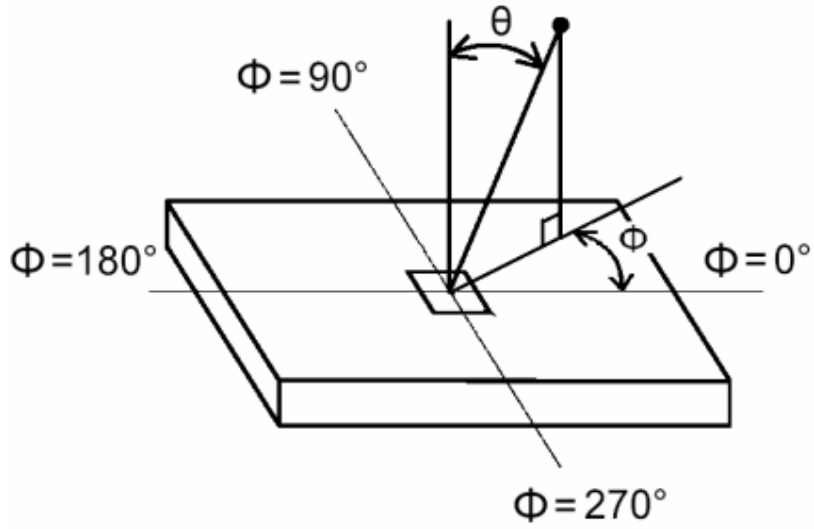

FIG.4-4 Viewing angle





5. Mechanical Characteristics

The contents provide general mechanical characteristics for the model T230XW01 V3. In addition the figures in the next page are detailed mechanical drawing of the LCD.

Outline Dimension	Horizontal (typ.)	546.0mm
	Vertical (typ.)	318.3mm
	Depth (typ.)	46.0mm (W/I Inverter & Shielding) 30.8mm (W/O Inverter & Shielding)
Bezel Opening	Horizontal (typ.)	512.2±1.0mm
	Vertical (typ.)	289.8±1.0mm
Active Display Area	Horizontal	508.152mm
	Vertical	285.696mm
Weight	3300g (typ.)	
Surface Treatment	Anti-Glare, 3H	



Front View

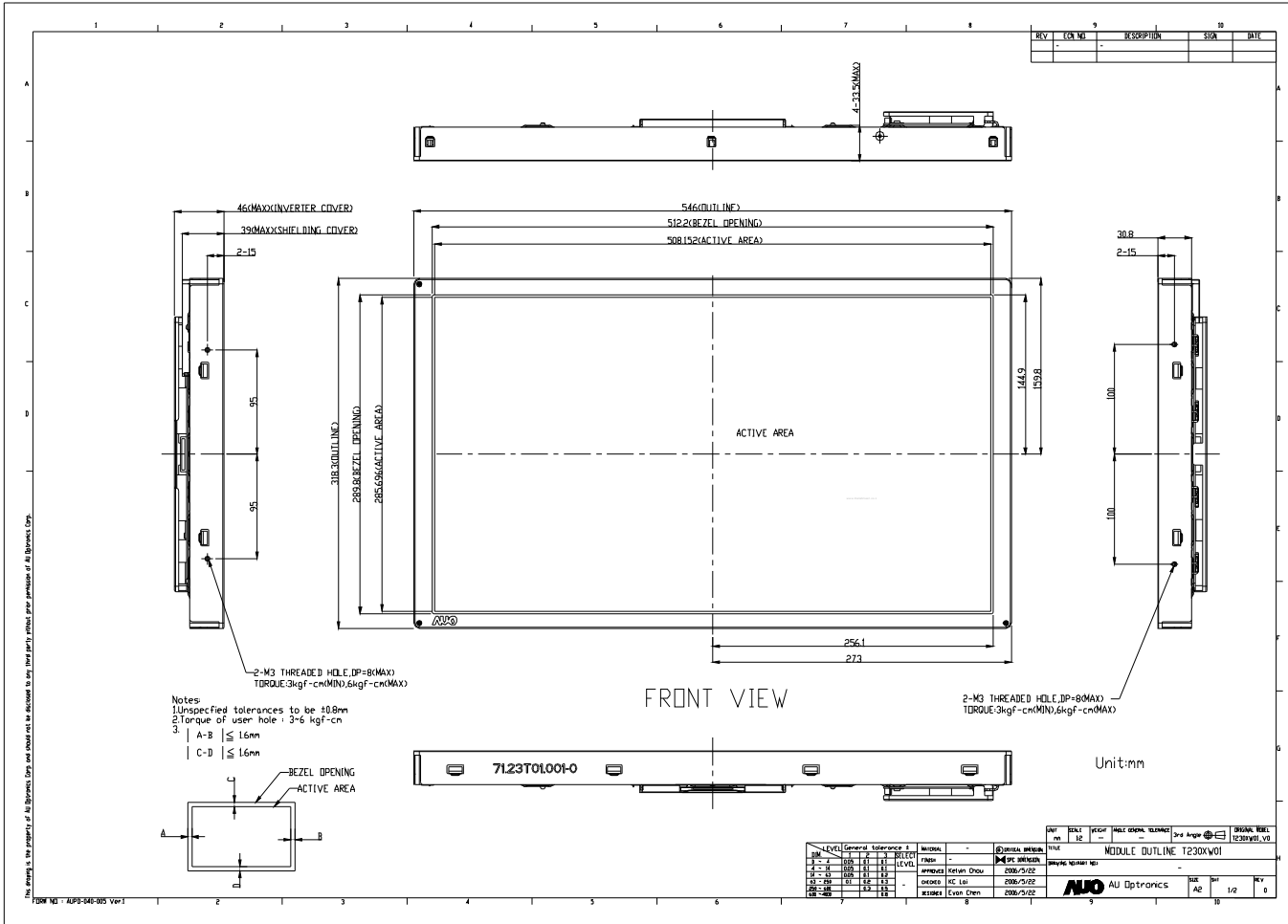



6. Reliability

Environment test condition

No	Test Item	Condition
1	High temperature storage test	Ta=60 °C 240h
2	Low temperature storage test	Ta=-20 °C 240h
3	Temperature Humidity Bias	Ta=50 °C 80%RH 240h
4	Low temperature operation test	Ta=0 °C 240h
5	High temperature operation test	Ta=50 °C 240h
6	Vibration test (non-operating)	Wave form: random Vibration level : 1G RMS Bandwidth : 10-500Hz Duration: X, Y, Z 20min 11 mins/cycle one time each direction, 30 min for each time
7	Shock test (non-operating)	Shock level: 50G Waveform: half sine wave, 11ms Direction: ±X, ±Y, ±Z One time each direction
8	Vibration test (with carton)	Random Vibration:10~200Hz,1.5G,30minutes in each X,Y,Z direction
9	Drop test (with carton)	Height: 53.3cm 1 corner, 3 edges, 6 surfaces (ASTMD4169-I)

Note 1: Evaluation should be tested after storage at room temperature for one hour.

Note 2: There should be no change which might affect the practical display function when the display quality test is conducted under normal operating condition.

Note 3: Judgment: Function test and display OK.



7. International Standards

7-1. Safety

- (1) UL6500, Underwriters Laboratories, Inc. (AUO file number : E204356)
Standard for Safety of Information Technology Equipment Including electrical Business Equipment.
- (2) CAN/CSA C22.2 No. 950-95 Third Edition, Canadian Standards Association, Jan. 28, 1995
Standard for Safety of Information Technology Equipment Including Electrical Business Equipment.
- (3) EN60950 : 1992+A2: 1993+A2: 1993+C3: 1995+A4: 1997+A11: 1997
IEC 950: 1991+A1: 1992+A2: 1993+C3: 1995+A4:1996
IEC 60065
European Committee for Electro technical Standardization (CENELEC)
EUROPEAN STANDARD for Safety of Information Technology Equipment Including Electrical Business Equipment.

7-2. EMC

- a) ANSI C63.4 "Methods of Measurement of Radio-Noise Emissions from Low-Voltage Electrical and Electrical Equipment in the Range of 9kHz to 40GHz. "American National standards Institute(ANSI), 1992
- b) C.I.S.P.R "Limits and Methods of Measurement of Radio Interface Characteristics of Information Technology Equipment." International Special committee on Radio Interference.
- c) EN 55022 "Limits and Methods of Measurement of Radio Interface Characteristics of Information Technology Equipment." European Committee for Electrotechnical Standardization. (CENELEC), 1998



8. Packing

Label Sample



Green Mark Description:

For Pb Free products, AUO will add for identification.

For RoHS compatible products, AUO will add for identification.

Note. The Green Mark will be present only when the green documents have been ready by AUO Internal Green Team. (The definition of green design follows the AUO green design checklist.)

Carton Label

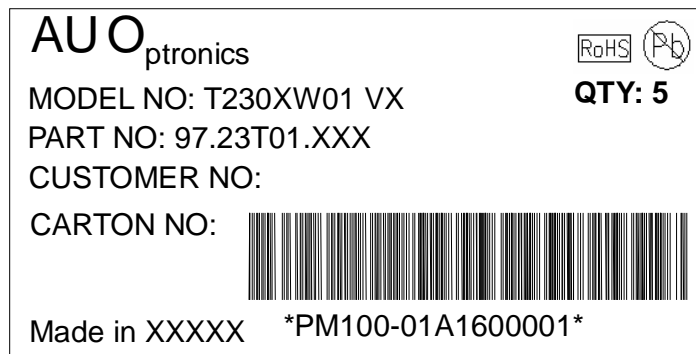

Packing size:

Carton Box: 370mm(W)x400mm(L)x655mm(H)

Pallet Size: 1140mm(W)*820mm(L)*123mm(H)

Shipping volume per pallet:

By Air: (3*2)*2 layers,
one pallet put 12 boxes,
Total 60ps module.

By Sea: (3*2)*3 layers,
one pallet put 18 boxes,
total 90ps module.

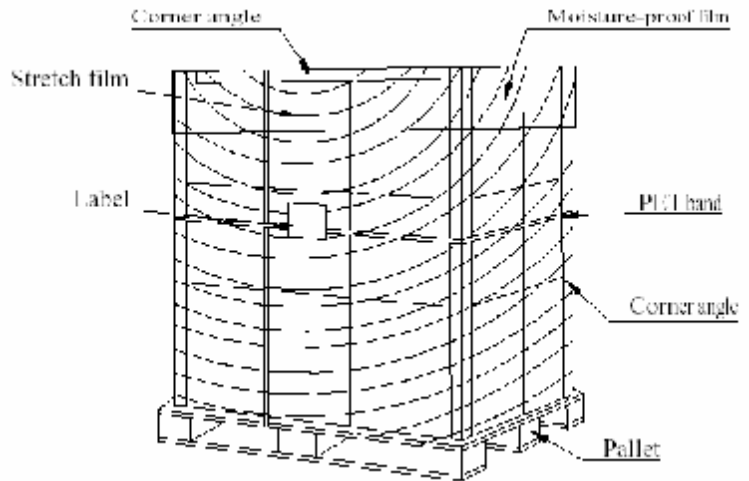

AUO

Packing process

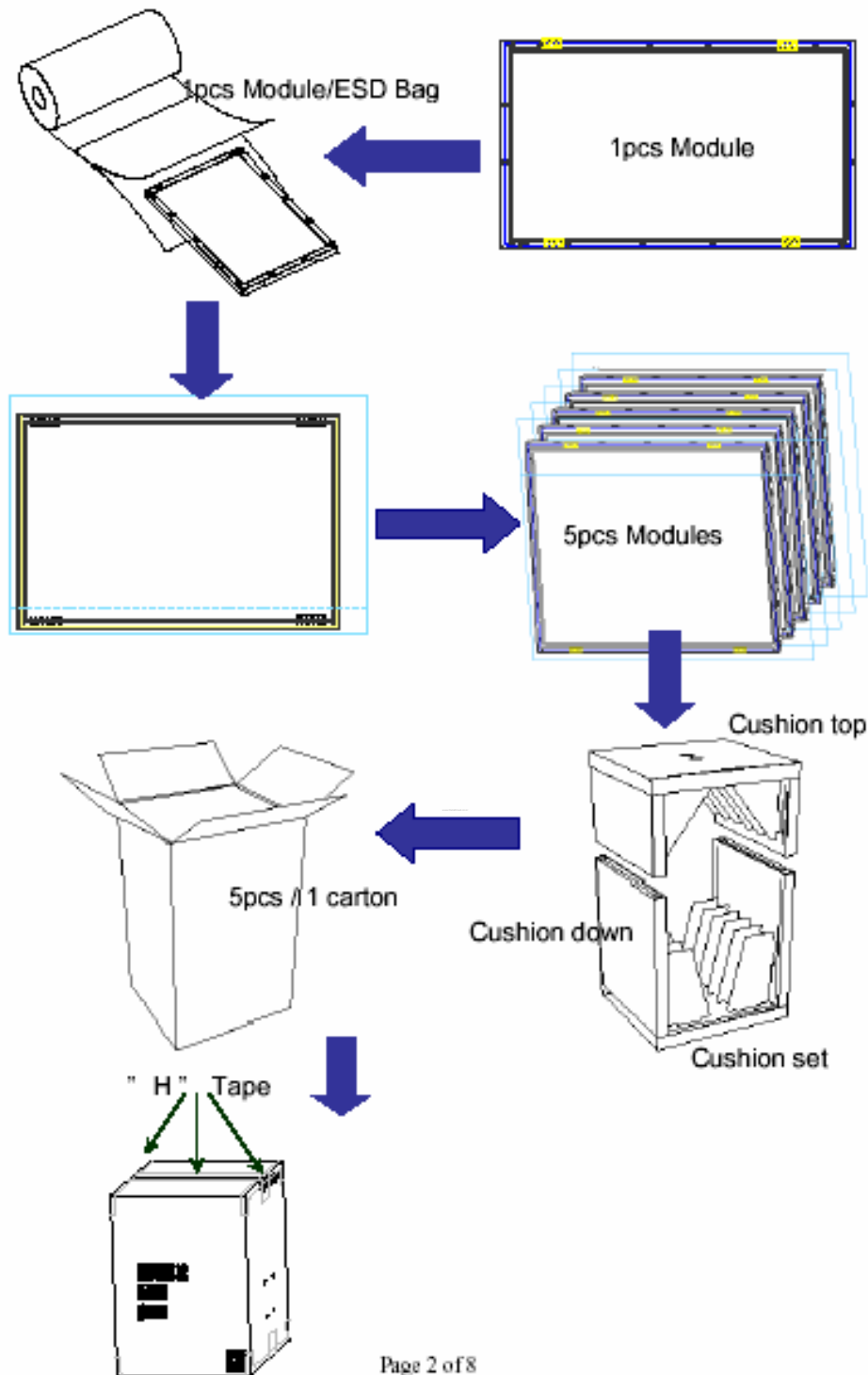



9. PRECAUTIONS

Please pay attention to the followings when you use this TFT LCD module.

9-1 MOUNTING PRECAUTIONS

- (1) You must mount a module using holes arranged in four corners or four sides.
- (2) You should consider the mounting structure so that uneven force (ex. Twisted stress) is not applied to module. And the case on which a module is mounted should have sufficient strength so that external force is not transmitted directly to the module.
- (3) Please attach the surface transparent protective plate to the surface in order to protect the polarizer. Transparent protective plate should have sufficient strength in order to resist external force.
- (4) You should adopt radiation structure to satisfy the temperature specification.
- (5) Acetic acid type and chlorine type materials for the cover case are not desirable because the former generates corrosive gas of attacking the polarizer at high temperature and the latter causes circuit break by electro-chemical reaction.
- (6) Do not touch, push or rub the exposed polarizers with glass, tweezers or anything harder than HB pencil lead. And please do not rub with dust clothes with chemical treatment. Do not touch the surface of polarizer for bare hand or greasy cloth. (Some cosmetics are detrimental to the polarizer.)
- (7) When the surface becomes dusty, please wipe gently with absorbent cotton or other soft materials like chamois soaks with petroleum benzene. Normal-hexane is recommended for cleaning the adhesives used to attach front/ rear polarizers. Do not use acetone, toluene and alcohol because they cause chemical damage to the polarizer.
- (8) Wipe off saliva or water drops as soon as possible. Their long time contact with polarizer causes deformations and color fading.
- (9) Do not open the case because inside circuits do not have sufficient strength.

9-2 OPERATING PRECAUTIONS

- (1) The spike noise causes the mis-operation of circuits. It should be lower than following voltage: $V=\pm 200\text{mV}$ (Over and under shoot voltage)
- (2) Response time depends on the temperature. (In lower temperature, it becomes longer..)
- (3) Brightness depends on the temperature. (In lower temperature, it becomes lower.) And in lower temperature, response time (required time that brightness is stable after turned on) becomes longer.
- (4) Be careful for condensation at sudden temperature change. Condensation makes damage to polarizer or electrical contacted parts. And after fading condensation, smear or spot will occur.
- (5) When fixed patterns are displayed for a long time, remnant image is likely to occur.
- (6) Module has high frequency circuits. Sufficient suppression to the electromagnetic interference shall be done by system manufacturers. Grounding and shielding methods may be important to minimize the interface.

9-3 ELECTROSTATIC DISCHARGE CONTROL

Since a module is composed of electronic circuits, it is not strong to electrostatic discharge. Make certain that treatment persons are connected to ground through wrist band etc. And don't touch interface pin directly.

9-4 PRECAUTIONS FOR STRONG LIGHT EXPOSURE

Strong light exposure causes degradation of polarizer and color filter.

9-5 STORAGE

When storing modules as spares for a long time, the following precautions are necessary.

- (1) Store them in a dark place. Do not expose the module to sunlight or fluorescent light. Keep the



temperature between 5°C and 35°C at normal humidity.

- (2) The polarizer surface should not come in contact with any other object. It is recommended that they be stored in the container in which they were shipped.

9-6 HANDLING PRECAUTIONS FOR PROTECTION FILM

- (1) The protection film is attached to the bezel with a small masking tape. When the protection film is peeled off, static electricity is generated between the film and polarizer. This should be peeled off slowly and carefully by people who are electrically grounded and with well ion-blown equipment or in such a condition, etc.
- (2) When the module with protection film attached is stored for a long time, sometimes there remains a very small amount of glue still on the Bezel after the protection film is peeled off.
- (3) You can remove the glue easily. When the glue remains on the Bezel or its vestige is recognized, please wipe them off with absorbent cotton waste or other soft material like chamois soaked with normal-hexane.

Appendix

1. Acoustical Noise Requirement

Measurement of all residual noises (e.g. back light, inverter, fans ...) will be done in a silent reverberant room. If available, the electronic box is placed under the LCD. Measure the sound level frequency dependant on 8 points around the LCD. The position in height of the sound audiometer is the middle of the LCD. Measures this on frequency span 25 Hz -20 kHz (gives an overview of the total spectrum) and measure this on frequency span 25 Hz - 1500 Hz.

Performance parameter	Class	LCD size	Requirement
General audible noise. Sound level.	ALL	ALL	< 20 (dBA)

$$\text{Sound level} = \frac{\Sigma \text{ sound level from A to H}}{8} \text{ (dBA)}$$

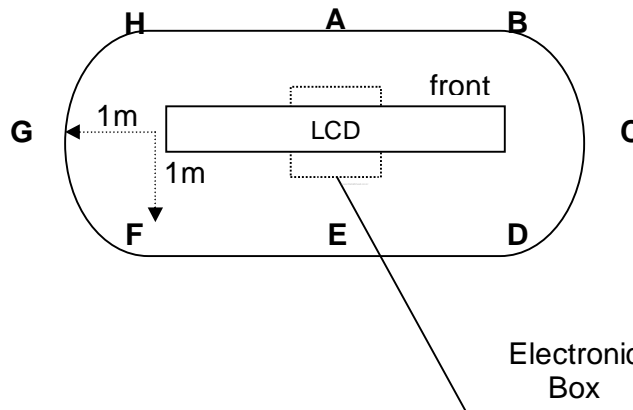

2. Luminance variation at 20% dimming ($\delta,5P$): 1.7(Max.)

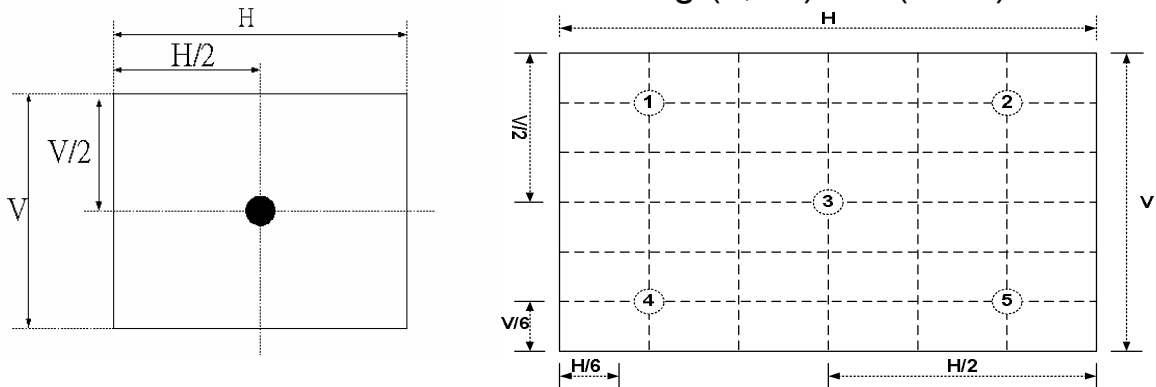

Appendix

3. Impedance of Pin9 of LVDS : 4.7K (Ω)
4. Impedance of Pin 11,12, and 13 of inverter input:
Pin 11: 120.7K(Ω), Pin 12: 113.6K(Ω), Pin 13: 208.1K(Ω), Pin 14: 102.1K(Ω)